



HAL
open science

Effect of nitrogen supply before bud break on early development of the young hybrid poplar

Suraphon Thitithanakul

► **To cite this version:**

Suraphon Thitithanakul. Effect of nitrogen supply before bud break on early development of the young hybrid poplar. Agricultural sciences. Université Blaise Pascal - Clermont-Ferrand II, 2012. English. NNT : 2012CLF22247 . tel-00797958

HAL Id: tel-00797958

<https://theses.hal.science/tel-00797958>

Submitted on 7 Mar 2013

HAL is a multi-disciplinary open access archive for the deposit and dissemination of scientific research documents, whether they are published or not. The documents may come from teaching and research institutions in France or abroad, or from public or private research centers.

L'archive ouverte pluridisciplinaire **HAL**, est destinée au dépôt et à la diffusion de documents scientifiques de niveau recherche, publiés ou non, émanant des établissements d'enseignement et de recherche français ou étrangers, des laboratoires publics ou privés.

UNIVERSITE BLAISE PASCAL
N° D.U. 2247

UNIVERSITE D'AUVERGNE
ANNEE 2012

**Ecole Doctorale Sciences de la Vie et de la Santé, Agronomie et
Environnement**
N° d'ordre : 582

Thèse

Présentée à l'Université Blaise Pascal pour l'obtention du grade de

Docteur d'université
(Spécialité : Ecophysiologie végétale)

Soutenue le 28 juin 2012

Suraphon THITITHANAKUL

Effect of nitrogen supply before bud break on early development of the young hybrid poplar

Président :

M. Jean-Louis JULIEN, Professeur d'université, UMR PIAF INRA-UBP, Clermont-Ferrand, France.

Membres :

M. Gilles PETEL, Professeur d'université, UMR PIAF INRA-UBP, Clermont-Ferrand, France (Directeur de thèse).

M. François BEAUJARD, Chargé de recherche, INRA, UMR PIAF INRA-UBP, Clermont-Ferrand, France (Directeur de thèse).

M. Michel CHALOT, Professeur d'université, Lorraine, Nancy; CNRS, Besançon, France.

Rapporteurs :

Mme. Monique BODSON, Professeur d'université, Liège, Belgique.

M. Philippe THALER, Directeur d' recherche, CIRAD, UMR Eco&sols, CIRAD-Supagro, Montpellier, France.

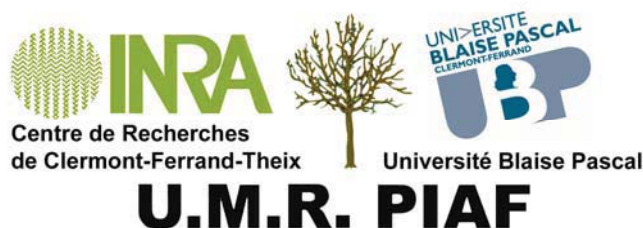

ACKNOWLEDGEMENT

I would like to acknowledge many people who have supported me in many different ways throughout the process of this doctoral journey.

I am grateful to my supervisors Dr. Gilles PETEL and Dr. François BEAUJARD for their continuous guidance, thoughtful suggestions, very useful ideas and critical comments.

My thanks go to the director of the laboratory UMR 547 PIAF INRA University Blaise Pascal and all staff for research support. I wish to thank Dr. André LACOINTE and Dr. Marc BONHOMME for data analysis; Nicole BRUNEL and Pierre CONCHON for bud section and photograph; Christian BODET and Christophe SERRE for sap flow data collection; Marc VANDAME, Brigitte GIRARD, and Brigitte SAINT JOANIS for kindly help in sample collection and laboratory work of sample analysis; Maurice CROCOMBETTE and Patrice CHALEIL for plant management; and Norbert FRIZOT for computer support.

I wish to thank Dr. David BIRON and Nadege ASTIER for prove reading and French teaching support, Unakorn SILPI and family for friendships and happiness times along in my life in France. I would like to express my gratitude to Dr. Philippe THALER, without your kindly support and suggestion I could not get a great opportunity to study in France.

My thanks go to Prince of Songkla University, Surattani Campus, Thailand and the France Embassy in Thailand for giving me opportunity and supporting me financially to pursue my PhD in France.

My warmest thanks to my loving family: mother and father, Thamrong, Peeraphan; and sisters and brother: Wandee, Wanjong, Therapong and Wanna for unconditional love, support, and patience through this PhD journey.

Résumé

Dans un sens large, le statut azoté de l'arbre impacte largement sa physiologie au printemps. Cependant la plupart des recherches conduites sur la remobilisation du carbone et de l'azote en cette période ont négligé l'hypothèse d'un rôle significatif de l'absorption d'azote avant le débourrement, en particulier, celui agissant en interaction avec l'utilisation des réserves carbonées et azotées et qui interviendrait dans la qualité de la croissance des jeunes pousses. Cette recherche a été entreprise avec une approche expérimentale et a été conduite avec de jeunes peupliers hybrides (*Populus tremula* × *Populus alba*, clone INRA 717-1B4). Ils ont été utilisés en nombre limité, mais présentaient, par construction initiale, des architectures différentes. Trois séries d'expériences ont ainsi été conduites en trois ans : tout d'abord avec le scion d'un an, puis une petite souche de deux ans et enfin, en associant les deux types de structure, une petite souche portant des réitérations équivalentes au scion d'un an. Les essais ont été conduits en environnement contrôlé et ont fait appel à trois régimes de fertilisation azotée appliquée en solution nutritive recyclée et pendant la transition « repos végétatif et reprise de croissance foliaire » : une fertilisation sans aucun apport en azote (i), un apport d'azote strictement limité à la période amont au débourrement (ii), un apport permanent en azote (iii).

Les résultats montrent que le peuplier peut absorber de l'azote avant le débourrement et que son absorption produit des effets significatifs. Elle conduit en particulier à une forte poussée racinaire qui permet d'augmenter la teneur en eau des tissus caulinaires. Selon les essais, l'effet de l'absorption d'azote avant débourrement et sur le débourrement lui-même dépend de la structure de la plante, de la structure des bourgeons et de la température de conservation hivernale pour le traitement de la dormance. D'autre part, l'application d'azote avant débourrement améliore significativement la croissance des nouvelles pousses en augmentant, avec un temps de croissance identique dans les essais, la surface foliaire et la matière sèche. L'absorption d'azote pendant la transition de croissance maintient en partie la teneur en azote des tissus des plantes et en améliore même la teneur dans les jeunes racines et les jeunes pousses. Elle influence aussi l'utilisation des réserves carbonées. Les résultats de cette étude montrent que l'azote appliqué au printemps et avant débourrement joue un rôle significatif sur la physiologie du jeune arbre et sa reprise de croissance au printemps.

Mots clefs : *Populus*, débourrement, nitrate, absorption minérale, réserves, azote, glucides, poussée racinaire.

Summary

Nitrogen status widely impacts tree physiological process. However, most research concentrated on endogenous carbon and nitrogen remobilization in spring neglected the hypothesis of significant effect of nitrogen uptake before bud break on nitrogen and carbohydrate reserve used, and the quality of new growth. This study undertook experimental-based research on young poplar (*Populus tremula* × *Populus alba*, clone INRA 717-1B4) with different structures. Three series of experiments were conducted in a coordinated manner: the one year old scion (i), the young stump (ii), and the system then reiterated associated the “stump”, and the “scion” (iii). The experiments were to study plants in a controlled environment with soilless culture and three terms of nitrogen supply: without nitrogen supply (i), with a limited supply prior to bud break (ii), and with continuous nitrogen supply (iii).

Results show that poplar can uptake nitrate before bud break and it found to have significant effect by induce a strong root pressure which in turn increased water content of all tissues. Accordingly, the effect of nitrogen uptake before bud break on bud break time depended on plant architecture, bud structure, and temperature during winter to break down bud dormancy. In addition, nitrogen uptake before bud break had significantly effect on the growth and development of new shoots after bud break by increase leaf area and dry weight of new shoots. It also influenced on the quantity of nitrogen and non-structural carbon reserves in all tissues especially increase nitrogen contents in roots and new shoots. Therefore, results indicate nitrogen supply before bud break plays a significant role on plant physiology and quality of the re-growth.

Keywords : *Populus*, bud break, nitrate, mineral uptake, nitrogen, sugar, reserves, remobilization, root pressure.

Contents

Chapter 1: Introduction	1
Chapter 2: Literature Review	3
2.1 Poplar Biology	3
2.1.1 Plant Area.....	3
2.1.2 Botany and Morphology.....	3
2.2 Bud Development	7
2.2.1 Bud Formation.....	7
2.2.2 Bud Break.....	11
2.3 Carbon	12
2.3.1 Photosynthesis and Carbon Storage	12
2.3.2 Carbon Remobilizes to Bud Break	14
2.4 Nitrogen	15
2.4.1 Nitrate Uptake	16
2.4.2 Control of Nitrogen Uptake.....	17
2.4.3 Nitrogen Storage.....	18
2.4.4 Nitrogen Remobilization	19
2.4.5 Nitrogen Impact Plant Growth and Development	20
2.5 Justification of Hypothesis and Objectives	23
Chapter 3: Experiments	26
3.1 Experiment I:	26
Nitrogen Supply before Bud Break Strongly Impacts Spring Development of One- Year Scion Poplar	26
3.1.1 Introduction	26
3.1.2 Material and Method	27
3.1.2.1 Plant Material	27
3.1.2.2 Mineral Uptake.....	28
3.1.2.3 Root Pressure.....	28

3.1.2.4 Sap Flow	29
3.1.2.5 Plant Harvest and Architecture	29
3.1.2.6 Nitrogen Analysis	31
3.1.2.7 Non Structural Carbon Analysis	32
3.1.2.8 Data Analysis.....	34
3.1.3 Results.....	35
3.1.3.1 Environments Control.....	35
3.1.3.2 Architecture before Start Experiment	35
3.1.3.3 Bud Break	37
3.1.3.4 Nitrogen Uptake.....	38
3.1.3.5 Root Pressure	39
3.1.3.6 Sap Flow	40
3.1.3.7 Plant Architecture	41
3.1.3.8 Nitrogen	43
3.1.3.9 Non Structural Carbon	46
3.1.3.10 Mineral Uptake	52
3.1.4 Discussion.....	54
3.1.4.1 Nitrogen Uptake.....	54
3.1.4.2 Root Pressures	54
3.1.4.3 Sap Flow	55
3.1.4.4 Plant Development.....	55
3.1.4.5 Nitrogen Content.....	57
3.1.4.6 Non Structural Carbon Content	59
3.1.4.7 Mineral Uptake	60
3.2 Experiment II:.....	62
Nitrogen Supply before Bud Break Influence on Early Spring Development of Stump-Poplars.....	62
3.2.1 Introduction.....	62
3.2.2 Materials and Methods.....	63
3.2.2.1 Plant Materials	63
3.2.2.2 Mineral Uptake	67
3.2.2.3 Root Pressure	67
3.2.2.4 Sap Flow	67
3.2.2.5 Plant Characteristics and Harvest	67
3.2.2.6 Nitrogen Analysis	68
3.2.2.7 Non Structural Carbon Analysis	69
3.2.2.8 Data Analysis.....	69
3.2.3 Results.....	70
3.2.3.1 Environment Control	70
3.2.3.2 Architecture before Start Experiment	70
3.2.3.3 Nitrogen Uptake.....	72
3.2.3.4 Root Pressure	74
3.2.3.5 Plant Architecture	76
3.2.3.6 Water Content.....	81
3.2.3.7 Nitrogen Content.....	82
3.2.3.8 Non Structural Carbon Content	84
3.2.3.9 Mineral Uptake	88

3.2.4 Discussion	92
3.2.4.1 Nitrogen Uptake	92
3.2.4.2 Root Pressure.....	92
3.2.4.3 Plant Development	93
3.2.4.4 Nitrogen Content	95
3.2.4.5 Non Structural Carbon Content.....	96
3.2.4.6 Mineral Uptake.....	98
3.3 Experiment III:.....	100
Nitrogen Supply before Bud Break Influence on Early Spring Development of Poplars Dependent on Low Temperature during Winter.....	100
3.3.1 Introduction	100
3.3.2 Materials and Methods	101
3.3.2.1 Tree Preparation	101
3.3.2.2 Mineral Uptake.....	105
3.3.2.3 Plant Characteristics and Harvest.....	105
3.3.2.4 Water Content.....	106
3.3.2.5 Nitrogen Analysis.....	106
3.3.2.6 Data Analysis	107
3.3.2 Results	108
3.3.3.1 Architecture at Start Experiment.....	108
3.3.3.2 Environment Control.....	110
3.3.3.3 Nitrogen Uptake	110
3.3.3.4 Water Content.....	111
3.3.3.5 Timing of Bud Break and New Shoot	112
3.3.3.6 Nitrogen of New Shoot.....	113
3.3.3.7 Mineral Uptake.....	115
3.3.4 Discussion	117
Chapter 4: General Discussion	121
4.1 Nitrogen Uptake.....	121
4.2 Nitrogen Uptake before Bud Breaks Influence on Nitrogen and Non Structural Carbon Reserve	123
4.3 Nitrogen Uptake before Bud Breaks Influences the development of Re-growth early Bud Break.....	127
4.4 Nitrogen Uptake before Bud Breaks Influence on Mineral Uptake	129
Chapter 5: General Conclusions and Recommendations	130
5.1 Conclusions	130

5.2 Recommendations	131
Chapter 6: References	132
Chapter 7: Appendix	146
7.1 Nutrient Uptake Measurement	146
7.1.1 Recirculating Nutrient System.....	146
7.1.2 Computation of Nutrient Uptake	147
7.2 Root Pressure Measurement	148
7.3 Sap Flow Heat Balance Measurement	150
7.3.1 The Theory.....	151
7.3.2 Sensor Design	153
7.3.3 Sensor Installation.....	155
7.4 Nitrogen Content Measurement	156
7.5 Estimation Nitrogen Mobilization of Compartment Tissues	156
7.6 Non Structure Carbon Content Measurement	160
7.6.1 Extraction Non-structure Carbon	161
7.6.2 Analysis of Glucose, Fructose, and Sucrose	162
7.6.3 Analysis of Starch	164
7.6.4 Preparation Chemical for Analysis Non Structure Carbon Content	167
7.7 Estimation Non Structure Carbon Mobilization of Compartment Tissues	169
7.8 Embedding in LR-White Resin and Bud Sections	172
7.8.1 Embedding in LR-White Resin.....	172
7.8.2 Section Bud Sample.....	173
7.9 Data Analysis	173

Table of content

Table 2.1 : Selected Previous Studies of the contribution of nitrogen remobilization to the seasonal growth of trees	22
Table 3.1 : Diameter length and volume of one-year scion poplar.....	35
Table 3.2 : Architecture of new shoots 15 days after bud break during the experiment period 2009.....	42
Table 3.3 : Measured N content in the start sample (<i>Start</i>) and estimated N content in <i>Control</i> , <i>N-Pulse</i> , and <i>N-Supply</i>	44
Table 3.4 : Nitrogen net flow in each compartment tissue compared to the total N content in new shoots	46
Table 3.5 : Measured non structural carbon content at the start sample (<i>Start</i>) and estimated non structural carbon in <i>Control</i> , <i>N-Pulse</i> , and <i>N-Supply</i>	48
Table 3.6 : The total non structural carbon used during the experiment period versus dry weight of new shoot, 15 days after bud break.....	51
Table 3.7 : Nutrient solution composition controls for N and calcium	65
Table 3.8 : Volume of branch, main stem, and whole plant before start experiment of the two-year-stump poplars.....	70
Table 3.9 : Numbers of leaf, dry weight of leaf, leaf area and leaf area ratio after bud break 2010.....	79
Table 3.10 : Nutrient solution composition control nitrogen.....	105
Table 3.11 : Volume of main stem, branch, and whole plant at start experiment 2011	108
Table 3.12 : Water content in bark and xylem of main stem after bud break during the experiment period 2011.....	112
Table 3.13 : Date of bud break, number of new shoot, and dry weight of new shoot	113
Table 3.14 : Nitrogen content and total nitrogen of new shoot at the end of experiment 2011.....	114

Figure of content

Fig. 2.1 : Angiosperm phylogeny showing the Eurosoid clade containing <i>Populus</i> and <i>Arabidopsis</i> , relative to other species	6
Fig. 2.2 : The annual cycle of a <i>Populus</i> sp.....	8
Fig. 2.3 : Schemes of the fate of successive primordia during short day induced apex bud set in poplar	9
Fig. 2.4 : Morphology of the axillary bud of <i>P. tremula</i> × <i>P. alba</i> clone INRA 717.1B4	10
Fig. 2.5 : Schematic nitrate uptake, representation in a plant cell impaled with a microelectrode	17
Fig. 2.6 : Scheme architecture of the two-years-old poplar.....	25
Fig. 3.1 : Scheme of plant samples during the start (<i>Start</i>) and the end (Control, N-Pulse, and N-Supply) experiment 2009.....	30
Fig. 3.2 : Environment conditions during experiment period 2009.....	36
Fig. 3.3 : Axillary bud break development stages A-F of the one-year scion poplar	37
Fig. 3.4 : Timing of axillary bud break (Stage C) during experiment period 2009	38
Fig. 3.5 : Cumulated nitrogen uptake ($\text{g}\cdot\text{plant}^{-1}$) during the experiment period 2009	39
Fig. 3.6 : Root pressure (kPa) during experimentations period 2009	40
Fig. 3.7 : Sap flow during the experimentation period 2009	41
Fig. 3.8 : Plant tissue dry weight during the experimentation period 2009.....	42
Fig. 3.9 : Nitrogen content of dry weight during the experimentation period 2009.....	43
Fig. 3.10 : Nitrogen net flows (% of stored nitrogen in tissues) 15 days after bud break during the experimentation period of 2009	45
Fig. 3.11 : Non structural carbon of dry weight ($\text{g}\cdot\text{g}^{-1}$) during the experimentation period 2009	49
Fig. 3.12 : Non structural carbon used during the experimentation period 2009	51
Fig. 3.13 : Cumulated potassium (a), phosphorus (b), calcium (c), and magnesium (d), ($\text{g}\cdot\text{plant}^{-1}$) taken up by the one-year scion poplar during the experiment period 2009.....	53
Fig. 3.14 : Morphology of axillary bud of poplars (<i>Populus tremula</i> × <i>Populus alba</i> , clone INRA 717-1B4) at the start of experiment period	56
Fig. 3.15 : Total leaf area in relation to total nitrogen in new shoots.....	57
Fig. 3.16 : Scheme architecture of the two-years stump poplar	66
Fig. 3.17 : Environmental conditions during experiment period 2010.....	71
Fig. 3.18 : Accumulated N uptake ($\text{g}\cdot\text{plant}^{-1}$) during the experiment period 2010.....	73
Fig. 3.19 : Root pressure (kPa) measurements during the experiment period 2010.....	75
Fig. 3.20 : Bud break development stages A-F of stump poplar	76

Fig. 3.21 : Time of bud break and number of bud break during the experiment period 2010.....	78
Fig. 3.22 : Plant photo during the end experiment 2010,.....	79
Fig. 3.23 : Plant tissue dry weight during the experiment period 2010	80
Fig. 3.24 : Water content of the tissues (g.g^{-1} of tissue DM) during the experiment period 2010.....	82
Fig. 3.25 : Nitrogen content of dry weight (mg.g^{-1} of tissue DM) during the experiment period 2010.....	84
Fig. 3.26 : Non structural carbon content in plant tissues (mg.g^{-1} of tissue DM) during the experiment period 2010.....	87
Fig. 3.27 : Cumulative potassium (a and b), phosphorus (c and d), calcium (e and f), and magnesium (g and h) uptake during the experiment period 2010	91
Fig. 3.28 : Nitrogen supply before bud break in <i>N-Pulse</i> , <i>N-Supply</i> , <i>N-Pulse/-Ca</i> , and <i>N-Supply/-Ca</i> treatments induced sap leak during the period 2010	93
Fig. 3.29 : Morphology of axillary bud of stump poplars (<i>Populus tremula</i> \times <i>Populus</i> <i>alba</i> , clone INRA 717-1B4) at the start of experiment 2010	95
Fig. 3.30 : Scheme of plant preparation during the experiment period 2011	103
Fig. 3.31 : Poplars were prepared three branches	103
Fig. 3.32 : Temperature of pre-treatment period on 3 November 2010 (307 days of year 2010) until 15 February 2011(46 days of year 2011).....	109
Fig. 3.33 : Cumulated nitrogen uptake (g.plant^{-1}) during experiment period 2011.....	111
Fig. 3.34 : Cumulate potassium (a), phosphorus (b), calcium (c), and magnesium (d) uptake (g.plant^{-1}) during experiment period 2011	116
Fig. 3.35 : Chill unit accumulation curves of Positive Chill Unit model.....	120
Fig. 4.1 : Nitrogen uptake (g.day^{-1}) during experiment I period 2009	121
Fig. 7.1 : Schematic representation of recirculating nutrient system.....	147
Fig. 7.2 : Xylem sap pressure measurement.....	150
Fig. 7.3 : Sap flow meter designed consists of a flexible heater	153
Fig. 7.4 : Detector of the differentiation temperatures.....	154
Fig. 7.5 : Thermopile detects the radial difference temperature between inside and outside fluxmeter.....	155
Fig. 7.6 : Protocol Carbohydrates Extraction.....	162
Fig. 7.7 : Microfilter Columns Pack.....	163
Fig. 7.8 : Protocol Starch Analysis.....	166

Abbreviation

Ala	:	Alanine
Arg	:	Arginin
Asn	:	Asparagine
Asp	:	Aspartic
ATP	:	Adenosine triphosphate
BSPs	:	Bark storage proteins
cHATS	:	Constitutive high affinity transport system
Cit	:	Citrulline
GABA	:	γ -aminobutyric acid
GDH	:	Growing degree hours
Gln	:	Glutamine
Glu	:	Glutamic acid
HATS	:	High affinity transport system
iHATS	:	Inducible high affinity transport system
LATS	:	low affinity transport system
LDs	:	Critical photoperiods long days
N	:	Nitrogen
NNF	:	Nitrogen net flow
NSC	:	Non structural carbohydrates
PCU	:	Positive Chill Unit model
R	:	Radial sections
SDs	:	Critical photoperiods short days
TNC	:	Total non structural carbohydrates
tZR	:	Trans-zeatin riboside
VSPs	:	Vegetative storage proteins

Chapter 1: Introduction

Trees in temperate climates are able to adapt to seasonal changes restricting their growth. The yearly activity of a deciduous tree present important plant physiology changes from growing to dormancy. During the spring, plants start to induce several mechanisms to support the full growth season of whole plant structures. As for all trees, the life of deciduous tree depends on the carbon and nitrogen (N) used and stored, as well as the balanced use of 'sink' and 'source' related to tree phenology stages and environmental conditions. Carbon is assimilated by photosynthesis during growing seasons and allocated as reserved carbon for plant survival. Then, this storage carbon sinks straightly during the periods when plants have low photosynthesis for winter maintenance respiration and leaves production in spring (Barbaroux *et al.*, 2003; Landhausser and Lieffers, 2003; Wong *et al.*, 2003). Thus, N supporting growth and development of deciduous trees is provided by the N uptake and remobilized N from internal stores (Millard *et al.*, 2006; Miller and Cramer, 2004; Tagliavini *et al.*, 1997).

Nitrogen remobilization is crucial for sustained plant growth during the early phase of re-growth after bud break (Millard, 1996; Tagliavini *et al.*, 1997; Malaguti *et al.*, 2001; Grassi *et al.*, 2003; Guak *et al.*, 2003; Millard *et al.*, 2006). However, previous studies found that N uptake during early spring, after bud break, was influenced on N remobilization to support re-growth which depends on plant characteristics such as size, age, species, and quality of young shoots from the start of transpiration as a mass sap flow (Tagliavini *et al.*, 1999; Millard *et al.*, 2001; Salaün *et al.*, 2005; Millard *et al.*, 2006). Moreover, some plant species can uptake N before bud break which is related to the plant physiology, requiring the compatibility of the active transport and metabolic activity of roots under suitable environmental conditions such as warm temperature of the soil, and the availability of N and water (e.g. Dong *et al.*, 2001; Delaire, 2005). However, there are few references in the literature about the concerning of N uptake via root before bud break (Delaire 2005). In addition, the particular role of N uptake is often neglected in this instance whereas it could take place in the physiological processes of remobilization during the transition period from bud dormancy to spring re-growth and the restarting of the mass flow.

Therefore, this study hypothesizes whether plants could uptake nitrogen before bud break and extends to whether the N uptake before bud break has significant impact on N and carbohydrate storages, and re-growth development. *Populus* was used for this study because it has been undertaken by several studies modeling plant biology (e.g. Cook, 2005; Regier *et al.*,

2009). In addition, the integration of genetics and physiology of poplar has been used to understand the detailed mechanisms of forest tree growth and development (Bradshaw *et al.*, 2000; Jansson and Douglas, 2007).

Generally, poplar is fast growth specie in areas with a temperate climate in Northern hemisphere. This deciduous tree intensively produces a biomass involved in the supply chain of bioenergy, paper, timber, and other wood products. The intensive short-rotation of poplar is closely related to its nutritional requirements (Aylott *et al.*, 2008; Karp and Shield, 2008). Therefore, in order to obtain the full benefit of high growth rates of the plant, nutrient limitation should be avoided by fertilization. The role of N to support the potential growth of poplar plantation has been pointed out by several studies, e.g. van den Driessche *et al.* (2008) and Yin *et al.* (2009). Therefore, N uptake during initiating spring may affect bud break and the development of re-growth. Then, the increased development of re-growth during early spring may be related to the growth and development of plant during spring and summer. However, poplar is never reported that it can uptake N before bud break. Consequently, the thesis purposes to fulfill two objectives:

1. Quantification of N uptake before bud break of poplars (*Populus tremula* × *Populus alba*, clone INRA 717-1B4), and
2. Extent to whether N uptake before bud break has a significant effect on N and non structure carbohydrate storage and new growth development.

The experiment-based research is common to all experiments in this thesis. The study undertook on plants in a greenhouse controlled environment and modalities of N supply using a recirculation nutrient system with the three treatments: (i) without N supply, (ii) with a limited N supply prior to bud break, and (iii) with continuous N supply. The parameters used to test the hypothesis are the dynamics of mineral absorption, the dynamics of growth and bud break, xylem sap pressure from before bud break, sap flow during the bud break, and the final compositions of the tissues with a focus on non structure carbohydrates and N. The analysis and integration of all these parameters were performed in order to account for the variation in the development of re-growth at bud break, and to propose explanations with some of the underlying physiological mechanisms, as well as to provide new knowledge for plant management in terms of nutrients uptake before bud break to support plant growth and development.

Chapter 2: Literature Review

2.1 Poplar Biology

Poplar (*Populus* spp.) is ecologically and economically important because of its contributions that meet the global need for paper, bioenergy, timber, and other wood products. Specifically, poplar can produce large intensively of biomass per unit land area and short-rotation coppice (Aylott *et al.*, 2008; Karp and Shield, 2008), and link to the greatest potential for carbon dioxide mitigation on environment (Curtis *et al.*, 2000). *Populus* has several advantages as a model system. An integration of genetics and physiology is being used to understand the detailed mechanisms of forest tree growth and development (Bradshaw *et al.*, 2000; Jansson and Douglas, 2007).

2.1.1 Plant Area

Poplars are found in temperate regions of the United States of America (USA), Europe, and Asia. Poplars are fast-growing, easy to vegetative propagate, and highly adaptable to a wide range of climatic and soil conditions. These characteristics, combined to the wide range of wood, fiber, fuel wood and other forest products and services they provide, have led to the widespread use of poplars and willows around the world. According to the International Poplar Commission (2008), the indigenous forest formations area of poplars in 2007 is estimated to 70.6 million ha. Indigenous poplar forests cover significant areas in some countries, notably Canada (28.3 million ha), the Russian Federation (21.5 million ha), USA (17.7 million ha) and China (3 million ha). Poplar plantation represents 5.3 million ha. The major countries for poplar plantations are China (4.3 million ha, which represents an increase of 3.9 million ha since 2004), France (236,000 ha), Turkey (125,000 ha), Italy (118,500 ha), Germany (100,000 ha), and Spain (98,500 ha). Traditionally, poplar used in forestry and integrated in agricultural systems, and more recently used as renewable energy sources and for soil remediation in contaminated sites.

2.1.2 Botany and Morphology

Populus (poplars, cottonwoods, aspens) is found in the angiosperm Euroside I clade together with Arabidopsis. Thus, *Populus* is more related to *Arabidopsis* than to the vast majority of other dicot taxa including those with trees, not to mention monocots or gymnosperm trees such as conifers, lineages, that separated from the eudicots long before the radiation of eudicot families 100–120 million years ago (Fig. 2.1).

Populus are deciduous trees that regularly lose their leaves in the fall. New growth initially originates from a preformed shoot within the bud where growth is initiated in the spring and the meristem continues to expand and grow throughout the season until bud set in the fall (Bradshaw *et al.*, 2000). Flowering in poplar occurs relatively early, compared to other woody plants, with flowering occurring in as little as 3-6 years from seed (Brunner *et al.*, 2004). The rapid growth rate of poplars enables them to reach large size. Poplar is called differently among regions, the common cottonwoods of North America (*P. deltoides* and *P. trichocarpa*), the black poplar of Europe (*P. nigra*), and the Asian balsam poplars (*P. maximowiczii*, *P. suaveolens*, *P. szechuanica*, *P. yunnanensis*). Generally, poplar is a common term of trees from *Populus* genus. The genus *Populus* is in the family of Salicaceae, which includes willows (*Salix* spp.), poplars (or cottonwoods), and aspens. All poplar species are diploid ($2n = 38$). A characteristic of this family is that the plants are dioeciously, meaning that they have either male or female flowers. Both male and female flowers are arranged as catkins (Heilman, 1999).

Catkins typically appear before the leaves in early spring, but unseasonably warm winter temperatures can force them earlier. Flowers of both sexes are born on cup-shaped disks lacking nectaries; bracts are rapidly deciduous. The number of stamens varies widely among species and ovaries can contain two to four carpels. After wind pollination, the fruit (an elongated cluster of capsules) sometimes likened to a necklace, matures in several weeks to a month or more. Capsules ripen and dehisce into two, three, or rarely, four parts (valves) before leaves are fully developed or as late as mid-summer, and the cottony seeds take to the air. The spent capsules abscise soon thereafter. Poplar seeds are tiny, averaging about 4,000 g^{-1} , but substantial variation (300 to 16,000 g^{-1} .) occurs among species and genotypes within a species; old trees can produce 30 to 50 million seeds in a single season (Wyckoff and Zasada, 2007).

Morphologically, poplar leaves are distinctive. They originate from vegetative axial or terminal buds that can be resinous and noticeably fragrant. Leaves usually bear glandular teeth along the margin which may be fine or very coarse and often glands at the junction of the petiole and lamina. Stipules are never persistent. Leaves are simple, usually with an elongated or pointed apex, but beyond that there is no common poplar phyllotype. Leaves may be linear, lanceolate, oblong, obovate, deltoid, cordate, rhombic, round, reniform, or palmately lobed; they may be longer than wide, wider than long, or equal in both dimension. Even on the same tree leaves may differ considerably in size and shape; preformed (early-season) leaves present as primordia in the dormant-season bud are usually smaller and distinctly different in shape than neoformed (late) leaves initiated by the apical meristem during the growing season. Short shoots and other determinate shoots produce only early leaves. Late leaves are produced on

vigorous, indeterminate shoots that elongate throughout the growing season and are typical of young trees, coppice sprouts, epicormic shoots, and the upper axes of the crown in older trees. Early leaves are more diagnostic morphologically than late leaves; i.e., they tend to be true to the unique phyllotype of a specie (Dickmann and Kuzovkina, 2008)

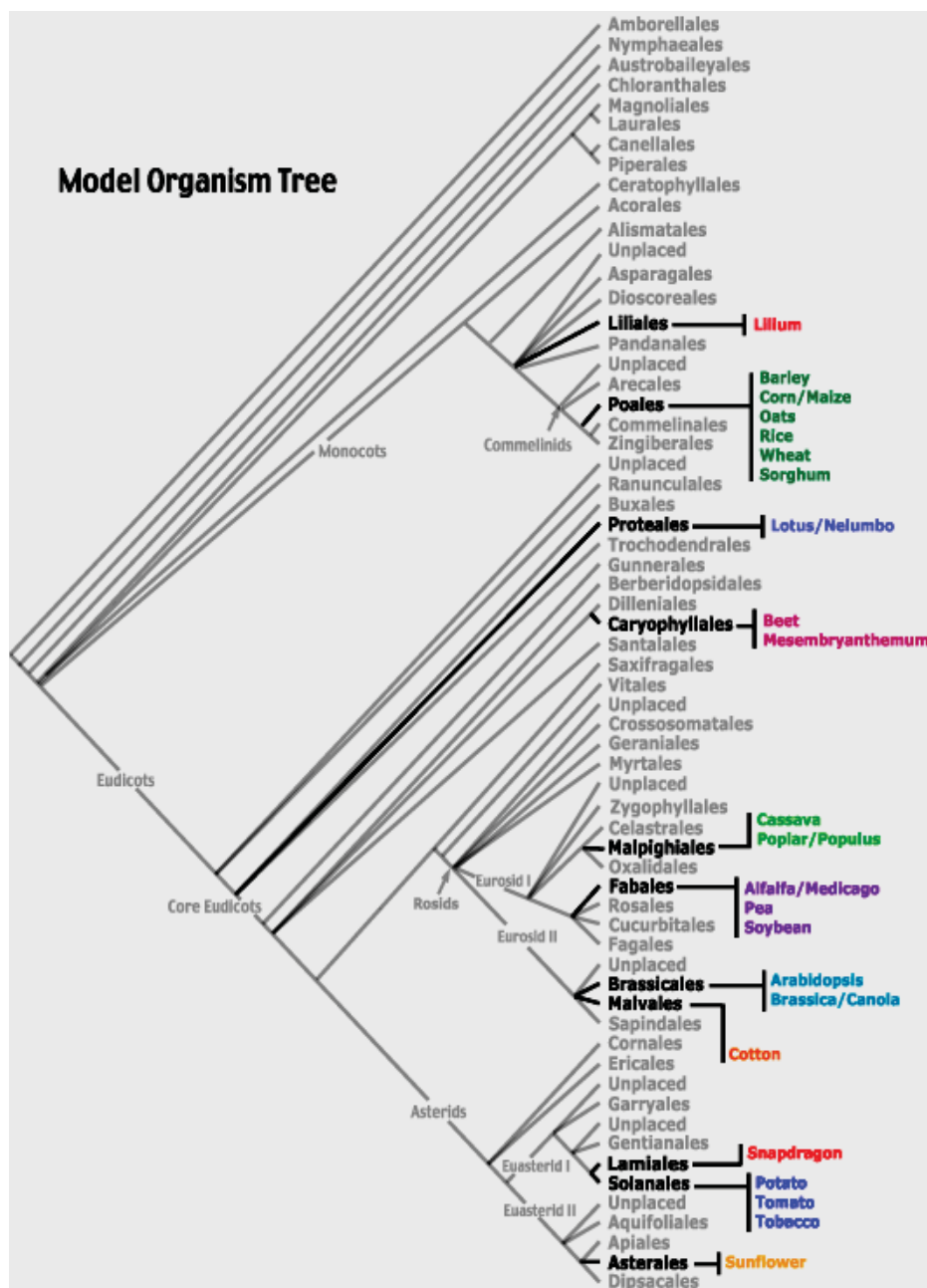

Fig. 2.1 : Angiosperm phylogeny showing the Eurosid clade containing *Populus* and *Arabidopsis*, relative to other species with significant sequence information (highlighted in color). Data and images from P.F. Stevens, Angiosperm Phylogeny Web site: <http://www.mobot.org/MOBOT/research/APweb/> (January 2010)

2.2 Bud Development

Generally, temperate trees develop strategies to cope controlled by interactions between environmental and internal factors. The seasonal cycle of growth and dormancy is a distinct feature of perennial plants and represents one of the most basic adaptations of trees to their environment. The recurrent transitions of meristems into and out of dormancy are of primary significance to plant productivity and survival. These transitions are tightly linked to the yearly dates of bud flush and bud set, and delimit the growing season. Trees use environmental cues, such as photoperiod and temperature, to synchronization mechanisms time growth and dormancy transitions (Fig. 2.2) (Rohde and Bhalerao, 2007).

2.2.1 Bud Formation

Apical bud formation and autumn senescence are accelerated by low temperature and longer nights, and clones exhibiting a late senescence had a faster senescence. Apical bud formation and autumn senescence appeared to be under the control of two independent critical photoperiods, long days (LDs) and short days (SDs). However, senescence could not be initiated until a certain time after bud set, suggesting that bud set and growth arrest are important for trees to acquire competence to respond to the photoperiodic trigger to undergo autumn senescence (Fracheboud *et al.*, 2009).

Poplar belongs to group of tree that shows continuous growth under long days and short days induce cessation growth and bud formation (Rohde *et al.*, 2002; Ruttink *et al.*, 2007). Low temperatures have been shown to induce apical bud formation and dormancy of *Populus tremula* × *Populus tremuloides* Michx. even under long days (Welling *et al.*, 2002). However, when studying temperature and short photoperiod interactions, warmer temperatures have been shown to induce earlier apical buds formation, growth cessation and dormancy development (Kalcsits *et al.*, 2009; Molmann *et al.*, 2005). Bud set condition can be mimicked by short day treatment. Apical bud formation begins immediately after the onset of short day, although it is not readily visible from its initiation. (Ruttink *et al.*, 2007). Apical bud set is achieved within 5 weeks in *P.tremula* × *P. alba* under a photoperiod of 8 h.day⁻¹ (Rohde *et al.*, 2002). Inside the forming bud, organogenesis proceeds to form embryonic leaves *sensu stricto*, each with two stipules, and leaf primordia without yet distinct stipules (Fig. 2.3)(Rohde *et al.*, 2002).

The axillary bud is different development stages at successive node position. The axillary buds exhibit developmental gradient: axillary buds at below the apex positions

'youngest' will only have initiated bud scales, whereas those in more mature positions will have produced bud scales and foliage leaves. For instance, the *P. tremula* × *P. alba* clone INRA 717.1B4 8 months old (3 September 2001) had 65 axillary buds (176 cm height), actively growing non-branched trees in the greenhouse, with a 16 h light per day photoperiod. The first distinguishable axillary bud below the apex only contained cataphylls, i.e. true bud scales that arise directly from the primordium (Fig. 2.4). Leaf primordium initiation was first observed in the 10th axillary bud and occurred until position 30th below the apex. Below position 30th, organ number in axillary buds did not increase (Rohde *et al.*, 2007).

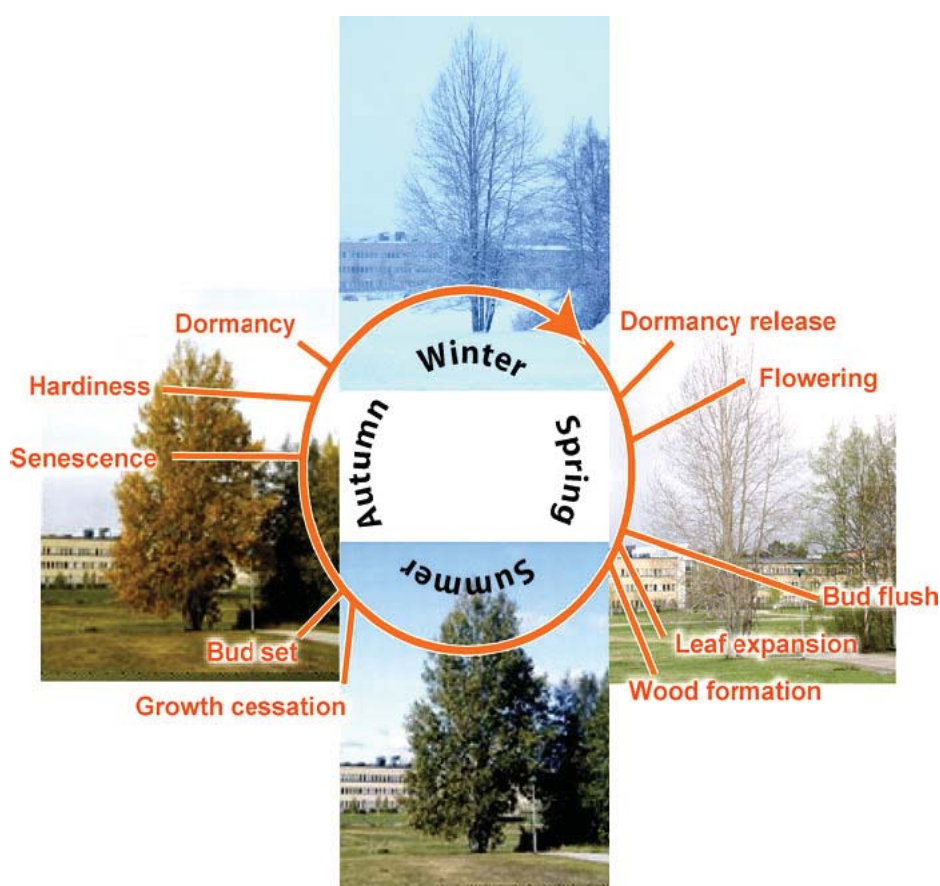

Fig. 2.2 : The annual cycle of a *Populus* sp. Poplars synchronize the onset of the dormant period mainly with changes in day length. Bud flush and bud set delimit the growing season. Prolonged exposure to chilling temperatures will release plants from dormancy. Growth resumes once the temperature passes a critical threshold. Absence of growth before and after endodormancy is caused by different environmental factors (Jansson and Douglas, 2007)

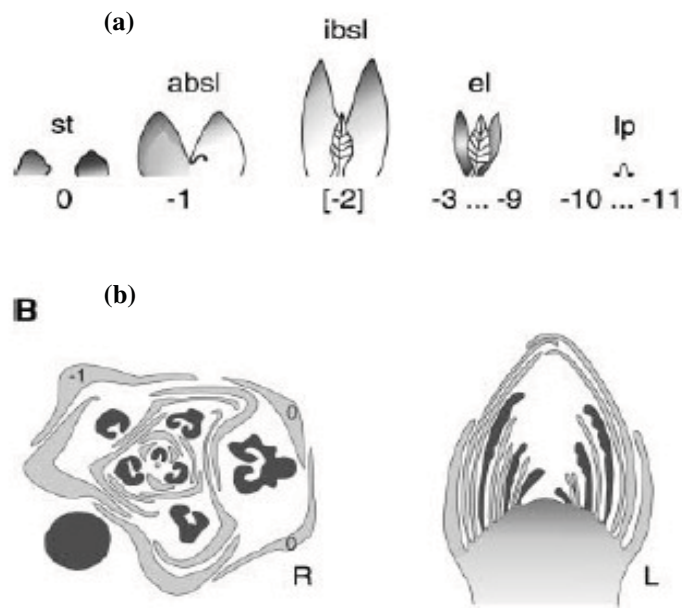

Fig. 2.3 : Schemes of the fate of successive primordia during short day induced apex bud set in poplar and of the morphology of the bud at accomplished bud set (Rohde *et al.*, 2002).

(a) After bud set has been completed, the following units of organs are found inside a *P. tremula* × *P. alba* bud (in successive order from outside to inside):

- One abortive bud scale leaf, consisting of two sometimes fused bud scales (primordium_1; absl);
- One incipient bud scale leaf, consisting of two bud scales and a small embryonic leaf lamina (primordium_2; ibsl [not always found]);
- Approximately seven embryonic leaves *sensu stricto*, consisting of two stipules and an embryonic leaf lamina (primordia_3 to_9; el); and
- Approximately two not yet developed leaf primordia (primordia_10 and _11; lp).

(b) Morphology of the bud after bud set has been completed. As a result of the helical phyllotaxis of the bud, radial sections (R) reveal approximately one-third more organs than longitudinal sections (L). In the schemes of radial and longitudinal sections, embryonic leaf lamina is dark gray and stipules and bud scales are light gray.

(a)

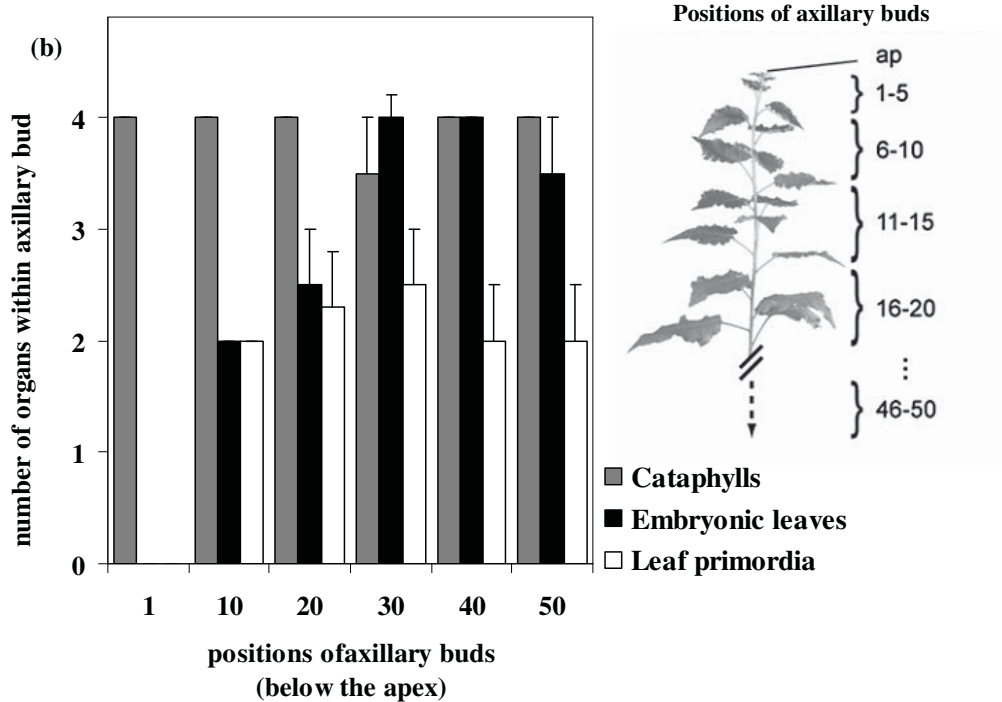
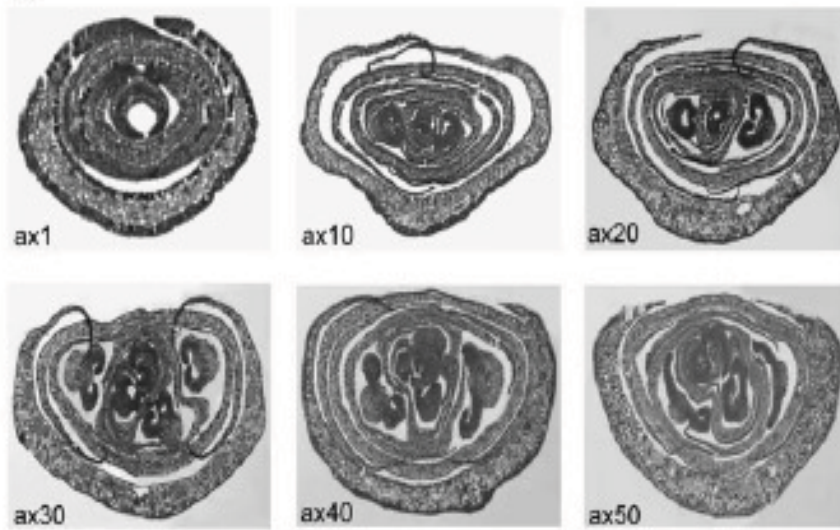

Fig. 2.4 : Morphology of the axillary bud of *P. tremula* × *P. alba* clone INRA 717.1B4 was harvested on 3 September 2001 from 8-month-old had 65 axillary buds (176 cm height). Greenhouse conditions, light intensity was $100 \text{ mol m}^{-2} \text{ s}^{-1}$ at plant level, with extension of the photoperiod to 16 h light. (a) Light microscopy of 1, 10, 20, 30, 40, and 50 below the apex. (b) Number of organs observed within the axillary buds at positions 1, 10, 20, 30, 40, and 50 below the apex (Rohde *et al.*, 2007).

2.2.2 Bud Break

Bud break is the visible event indicating the end of bud dormancy and the start of growth. Buds opening and sprouting are possible after plants were exposed to low temperature in winter until the chilling requirement of buds is fulfilled, and forcing the air and soil temperatures have passed a specific threshold (Hannerz, 1998; Linkosalo *et al.*, 2006). In example, the terminal buds of Douglas-fir (*Pseudotsuga menziesii* (Mirb.) Franco) seedlings have a chilling requirement of about 1200 h at 0–5°C. Once chilled, temperatures higher than 5°C force bud break via accumulation of heat units (Bailey and Harrington, 2006). Cesaraccio *et al.* (2004) predict that chilling requirement of *Populus tremula* is about 154 chilling days at 10.1°C. Strong relationship between winter temperature and dormancy release implies that even small change in winter temperature could have large impacts on the timing of bud break in the spring (Heide, 2003; Linkosalo *et al.*, 2006; Myking, 1999; Myking and Heide, 1995; Partanen *et al.*, 1998; Yu *et al.*, 2010). Warm autumn temperature has been shown to induce deep dormancy. Those affect bud break delay in northern ecotypes of birch (*Betula* sp.) (Heide, 2003). Myking and Heide (1995) found that bud break of birch (*Betula* sp.) occurs normally in seedlings over wintered at 12°C, but was erratic and delayed in seedlings over wintered at 15°C and especially at 21°C.

Bud break period is an essential template of plant. That is associated with changes in the content of carbohydrates and other substances, such as nucleic acids, proteins, polyamines, amino acids, organic acids and changes in the respiration rate (Sauter and Vancleve, 1992). Carbohydrates are the main source of energy for the metabolic changes occurring during the dormant period (Landhäusser and Lieffers, 2003). Moreover, soluble sugars are also recognized as important signaling molecules involved in many processes in bud break (Maurel *et al.*, 2004). Besides, nitrogen compounds and nitrogen cycling in woody plants appear to be an important component of nitrogen used efficiency in deciduous trees. A large amount of leaf nitrogen (50% to 90%) translocated from senescing leaves in autumn, stored as protein in shoot and root bark, and xylem ray cells, and then reused during regrowth in spring, after break dormancy (Coleman *et al.*, 2004; Frak *et al.*, 2002)

During bud break initiation in spring, metabolisms in buds are the main sink using soluble mineral from root uptake and metabolic allocate, especially carbon and nitrogen in the other parts of the plant. However, plant remained to several stresses, including light (intensity and day length), temperature, water stress, and embolized vessels. Accordingly, plant developed re-hydration mechanisms allowing buds, stem and root reconnection. Such re-hydration can occur through the replacement of embolized vessels with new functional vessels

and refilling of embolized vessels through an active mechanism. The first mechanism is common to all plant species with a secondary cambium, but its efficiency during bud break depends on the timing of radial growth resumption. The second mechanism, i.e. the refilling of embolized vessels through positive pressures in the xylem. For example, walnut induced the recovering of stem pressure, root pressure and the formation of a new ring of functional xylem, whereas in peach the primary mechanism was formation of a new ring of functional xylem (Ameglio *et al.*, 2002; Ewers *et al.*, 2001).

2.3 Carbon

2.3.1 Photosynthesis and Carbon Storage

Plants are photosynthetic organism which use light energy to produce nutrients (i.e. carbohydrate). Such nutrient can be used at a later time to supply the energy needs of the cell. Photosynthetic carbon assimilation is the primary transducer of energy for growth and reproduction. The carbon metabolism of plant is regulated in order to maintain these different function and to sustain plant growth, development and metabolism in tissues. Moreover, environments factor can severely impact of photosynthetic capacity of leaf (Lawlor, 2009) such as temperature (Ow *et al.*, 2010), light (Gansert and Sprick, 1998), drought (Regier *et al.*, 2009), atmospheric CO₂ (Curtis *et al.*, 2000), and available nitrogen (Ripullone *et al.*, 2003). For example, soil nitrogen availability limits *Populus tremuloides* photosynthesis under elevated CO₂ environment, but not ambient one (CO₂ 373 ± 2 ml l⁻¹) (Kubiske *et al.*, 1997).

Products of photosynthetic carbon assimilation are allocated to storage tissues or growth and development tissues from “source” sites to “sink” sites by phloem and xylem. The assimilate fluxes from sources to sinks are mainly dependent on the source-sink distances and on the respective abilities of the different sinks to take up and the assimilation that are available to them (Lacointe, 2000). For example, Mayrhofer *et al.* (2004) calculated daily carbon balance of mature poplar leaves (*Populus canescens*). They found that young poplar uses carbon assimilation of mature leaver photosynthesis by isoprene emission and dark respiration amount of 1% (percent of total carbon delivered to a leaf per day) and 20%, respectively. All carbon mobilization is loaded into the phloem, accounting for 28% of carbon exported from poplar leaves. Moreover, the transport of carbon within northern red oak seedling during a second flushing show that more than 90% of labeled carbon (¹⁴C) assimilation translocated from first flush leaves was directed upward to developing second flush leaves and stem, while about 5% was found in lower stem and roots. When second leaves were fully expend, only

about 5% of the ^{14}C exported from first flush leaves was translocated upward, while 95% was translocated downward to lower stem and roots (Dickson, 1989).

In addition to such results, Dyckman *et al.* (2000) found that the main carbon sink in the first six weeks of beech (*Fagus sylvatica* L.) after bud break were the leaves, representing 56% of the new assimilation. Carbon assimilation was translocated to belowground about 12.4% of the new assimilation. The carbon assimilation reached its maximum from 7 to 12 weeks after bud break when leaves apparatus was established. Leaves accumulate 12% of new carbon assimilation, whereas increase translocation to belowground carbon was about 55%. From 13 to 18 weeks after bud break, the belowground dominance of assimilation transport, may indicate that the carbon accumulated towards the end of growth period is prepared for the next year's leafing (Dyckmans *et al.*, 2000). Therefore, the net photosynthesis assimilation translocated to tissues would depend on tissue demand for growth and development or life cycle of plant.

Carbon is stored in many forms, but starch is the main source of carbon storage in plant. Carbon is also accumulated in the wood and bark in both root and stem via the photosynthesis between summer and autumn. Basically, carbon is allocated to storage reserves plant survival, when the current level of carbohydrates produced by photosynthesis is not enough to meet the carbohydrates demand for maintenance, growth or metabolism. Especially, the storage carbohydrate is maintenance respiration in the winter and builds leaves in the spring (Barbaroux *et al.*, 2003; Landhäusser and Lieffers, 2003; Landhäusser and Lieffers, 2002; Rowe *et al.*, 2002; Wong *et al.*, 2003). Carbon stored in the root system is considered to be very important for regeneration and growth of *Pinus taeda*, and *Populus tremuloides* (Landhäusser and Lieffers, 2003; Landhäusser and Lieffers, 2002; Ludovici *et al.*, 2002). The mobilization and utilization of stored carbon implies the hydrolysis of starch and the synthesis of sugar such as sucrose, glucose, fructose and raffinose (Sauter and Vancleve, 1994; Witt and Sauter, 1994; Wong *et al.*, 2003).

Cycles of carbon remobilization and utilization change according to seasons. The seasonal patterns of production, accumulation, and utilization of non structural carbohydrates (NSC) of deciduous trees are closely correlated to phenological events and (or) physiological processes. Wong *et al.* (2003) studies on maple tree show that starch is the major storage reserve carbohydrate in sugar maple, (*Acer saccharum* Marsh.). Starch is accumulated in the xylem ray tissues in late summer and early fall. During the cold season, there is a close relationship between starch hydrolysis-accumulation and temperature. Starch concentration was decreased during the cold months with soluble sugars (sucrose, glucose, fructose, xylose,

raffinose, and stachyose) was increased. Thus, these sugars were synthesis may play a role in cold tolerance. At the end of dormancy and the dehardening process, the levels of soluble sugars decline as starch level increases, prior to carbon mobilization for primary growth activities (Wong *et al.*, 2003).

To confirm the role of season on the concentration of starch and sugar, Landhäuser and Loeffers (2003) undertook research on poplar trees. They determined that starch and sugar concentration in roots, crown and stem of *Populus tremuloides* also depended on season. Starch concentration in roots, crown and stem tissues remained high during late summer and autumn, dropped in the winter months. Starch content of roots and crown remained low during bud flush. Soluble sugar concentration in roots increased at late fall and remained relatively constant to the week before bud flush. Concentration of soluble sugars in the crown remained relatively constant during late summer and winter until before bud flush. Upon bud flush, soluble sugar concentration in the large branches decreased, while the soluble sugar concentration of the current shoots increased. Soluble sugars in the stem tissue increased during leaf abscission while sugar concentration increased in the phloem/bark and dropped in xylem during bud flush. Therefore, carbon storage can remobilize to allow respiration, growth and development. In addition to the seasonal changes affecting carbon storage, it also depends on cropping management in growth period. Some studies in apple and peach found that limiting available nitrogen during summer or autumn before leaves falling increased NSC in the next spring (Cheng *et al.*, 2004; Cheng and Fuchigami, 2002; Jordan *et al.*, 2011).

2.3.2 Carbon Remobilizes to Bud Break

Carbon is very important for bud break, during winter and spring. After come out of endodormancy to bud break period which bud is sink strength, plants need to use the large amount of carbon to have a high capacity to synthesize ATP, which is involved in many metabolic pathways. Bud break requires NSC supply for metabolic reactivation and leaf primordial growth. Local reserves could closely relate to local within the bud itself or in the neighboring tissues of the stem (Bonhomme *et al.*, 2009; Maurel *et al.*, 2004). If the NSC used for bud break is stored far away in the stem such as root, they have to be transported from the source tissue to the bud by xylem. Thus, xylem sap has been proposed as the principal route for soluble carbohydrate to be transported from exporting tissue to buds. The transport of NSC in xylem sap was studied in various plants. Decourteix *et al.* (2008) found that at the beginning of bud break in walnut (*Juglans regia* L. cv. 'Franquette'), a higher xylem sap sucrose concentration and a higher active sucrose uptake by xylem parenchyma cells were found in the apical portion (bearing buds able to burst) than in the basal portion (bearing buds unable to

burst) (Decourteix *et al.*, 2008). Bonhomme *et al.* (2009) propose that close to bud break in walnut, buds were able to import high sugar quantities from the xylem vessels. The flow rates between xylem vessels and bud increased 1 month before bud break and reached $2000 \mu\text{g sucrose h}^{-1}\text{gDW}^{-1}$. Maurel *et al.* (2004) accepted that hexoses are of greater importance than sorbitol or sucrose in the early events of bud break in peach. Therefore, the carbohydrate supplies of bud will depend on in xylem transport.

For poplar, *Populus tremuloides*, the transport of reserve carbohydrate was found in the study of Landhäusser and Lieffers (2003). They suggest that the major source of carbohydrate storage allowing bud break comes from the stem and tree crown. As stated earlier, before leaf flush the decreased of sugar concentrations in the phloem/bark tissues of the stem coincided with a build up of the starch reserves in the large branches of the crown. Thus, the actual total NSC reserves in the stem dropped at that time. During bud flush, the total NSC suddenly decline in the crown tissues. This decrease in starch and sugar content in the large branches, in combination with the significant increases of sugar concentrations in the current shoots and breaking buds at the flush, suggests a mobilization and transport of NSC reserves towards the sprouting buds and unfolding leaves. This large decline in total NSC concentrations in the branches was accompanied by a smaller and not significant decrease in the roots, in combination with a slight but significant increase in the sugar concentrations in the xylem at the time of leaf flush (Landhäusser and Lieffers, 2003). Accordingly, the decrease of carbon storage of the pervious year relates to the decrease of leaf area and re-growth biomass (Landhäusser and Lieffers, 2002). However, Cheng and Fuchigami (2002)'s study on apple revealed different result. It is there postulated that young plants with low carbohydrate reserves and high nitrogen reserves produced a larger total leaf area at the end of the re-growth period than plants with high carbohydrate reserves but low nitrogen reserves. In their study, rather than carbohydrate reserves, nitrogen is another nutrient playing a key role on plant re-growth. Therefore, similar to the carbon storage, nitrogen storage during bud break period could be another factor impacting plant re-growth.

2.4 Nitrogen

Nitrogen (N) is the main mineral element in plant tissues and almost the entire amount is acquired from soil by roots. The N availability commonly limits plant productivity (Finzi *et al.*, 2007) by supporting growth process and increasing quality and quantity of new shoot. In this regard, N uptake during deciduous trees growth has two sources: (i) uptake of external sources such as NO_3^- and NH_4^+ ; and (ii) remobilization of internal reserves (Millard *et al.*, 2006; Miller and Cramer, 2004; Tagliavini *et al.*, 1997).

2.4.1 Nitrate Uptake

Generally, nitrate is actively transported across the plasma membranes of epidermal and cortical root cells, but net uptake is the balance between active influx and passive efflux. This transportation requires energy input from the cell over almost the whole concentrations range encountered in the soil (Glass *et al.*, 1992 ; Glass *et al.*, 2002; Miller and Smith, 1996; Zhen *et al.*, 1991). It is accepted that NO_3^- uptake is coupled with the movement of two protons down an electrochemical potential gradient, and is therefore dependent on ATP supply to the H^+ -ATPase that maintains the H^+ gradient across the plasma membrane (Crawford and Glass, 1998; Forde, 2000; Miller and Cramer, 2005; Miller and Smith, 1996). It is commonly accepted that roots operate nitrate uptake by three types of transport systems, to manage with the different external NO_3^- concentrations: two high affinity transport system (HATS) are about to take up NO_3^- at low external concentration. The constitutive system (cHATS) is available even when plants have not been previously supplied with NO_3^- . The inducible system (iHATS) is stimulated by exogenous NO_3^- . A low affinity transport system (LATS) is most important at high external NO_3^- concentration (Chen *et al.*, 2008; Miller and Cramer, 2005; Miller *et al.*, 2007; Rennenberg *et al.*, 2010).

After nitrate is uptake into the cell, nitrate has four fates: (1) reduction to NO_2^- by the cytoplasmic enzyme nitrate reductase (which enters the plastid and is reduced to ammonia and then incorporated into amino acid); (2) efflux back across the plasma membrane to the apoplasm; (3) influx and storage into the vacuole; and (4) long-distance translocation to the leaves by entering into xylem vessels (Fig. 2.5). Following long-distance translocation, NO_3^- must leave the xylem and enter the leaf apoplasm to reach leaf mesophyll cells, where NO_3^- is again absorbed and either reduced to NO_2^- or stored into the vacuole (Crawford, 1995; Crawford and Glass, 1998).

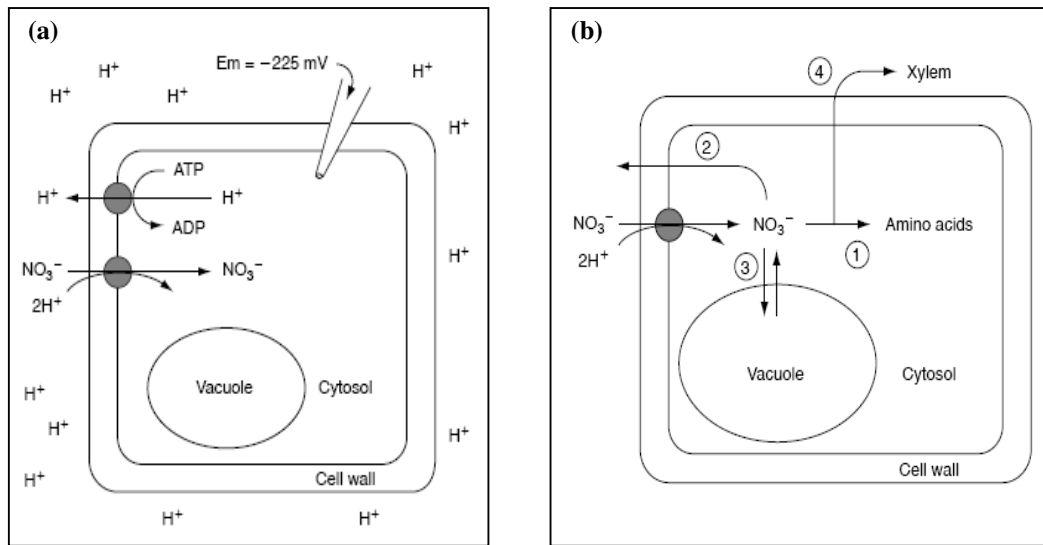

Fig. 2.5 : Schematic nitrate uptake, representation in a plant cell impaled with a microelectrode. The membrane electrical potential is given as -225 mV (negative inside cell) but can typically vary from -50 to -250 mV . Also shown are the proton ATPase, which provides the primary electrical gradient and proton motive force for secondary active transport and a nitrate transporter, which co-transported two protons per nitrate ion (a). The fate of nitrate (NO_3^-) uptake in the cell (b) (Crawford and Glass, 1998)

2.4.2 Control of Nitrogen Uptake

Nitrogen is available in many different forms in the soil; the three most abundant forms are nitrate, ammonium, and amino acids. The relative importance of these different soil N pools is difficult to measure and depends on many different environmental factors (Miller and Cramer, 2004). Basically, N acquisition from soil depends on both external and internal factors. External factors are salinity (Dluzniewska *et al.*, 2007; Ehling *et al.*, 2007), heat, drought, flooding (Rennenberg *et al.*, 2009) and the atmospheric CO_2 . In addition, elevated CO_2 concentration in the atmosphere is reported to increase N uptake in loblolly pine (*Pinus tadea*), sweetgum (*Liquidambar styraciflua*) and poplar (*Populus tremuloides*, *P. nigra*) (Curtis *et al.*, 2000; Finzi *et al.*, 2007; Luo *et al.*, 2006; Luo *et al.*, 2008). Dong *et al.* (2001) reported that apple tree has no N uptake before bud break when growing in soil at 8°C , whereas N uptake enhances with increasing soil temperature, between 12°C and 20°C . European beech (*Fagus sylvatica*) and Norway spruce (*Picea abies*) uptake nitrate at the soil temperatures of 10°C - 15°C , amounted 16% and 11%, respectively, of maximum uptake at 25°C . By contrast, net uptake of ammonium at 10°C reached 73% and 31% of the maximum uptake for spruce and beech trees, respectively (Gessler *et al.*, 1998). Poplar uses NO_3^- and NH_4^+ according to soil pH : NH_4^+ uptake favoured at high soil pH and NO_3^- uptake favoured at low soil pH (DesRochers

et al., 2003; DesRochers *et al.*, 2007). Other reports showed that differential N availability modulated N pools in plant tissues (Cooke *et al.*, 2005; Nicodemus *et al.*, 2008; Otto *et al.*, 2007; Rowe *et al.*, 2002). However, external factors have to be sent and converted to shoot-to-root signals that are part of a signalling cascade. Such signalling cascade ultimately controls N acquisition by roots under changing developmental and environmental conditions.

Concerning internal factors, plant roots are regulated to adapt to current N demand for growth and development, leaf and root senescence, as well as the N storage requirement of the whole plant (Kunkle *et al.*, 2009; Millard, 1996; Ozbucak *et al.*, 2008; Silla and Escudero, 2003; Tian *et al.*, 2005). Net NO_3^- uptake is regulated by whole plant demand and concentration of N metabolites, including NO_3^- in the tissue (Vidmar *et al.*, 2000). Kirkby and Armstrong's (1980) study provided direct evidence that root NO_3^- uptake is regulated by NO_3^- reduction in the leaf. Touraine *et al.* (1992) showed that N uptake increased when NO_3^- supply of shoots increased, and decreased when the nitrate reductase activity in shoots was inhibited by tungsten (WO_4^{2-}). In addition, internal signals communicating the N status of the plant are of importance as they coordinate root N uptake with the actual N demand of the whole plant (Imsande and Touraine, 1994). Reduced N compounds, which are able to cycle between shoot and root via xylem and phloem transport, can signal the N demand of the shoot to the roots and/or exert direct feedback regulation on N uptake in the roots (Grassi *et al.*, 2003). An exogenous supply of particular amino acids results in a significant decrease in NO_3^- uptake in different species and glutamine seems to play a dominant role in this process (Miller *et al.*, 2007). Exogenous supply of glutamine feeding also increases various amino acids (Gln, Glu, Ala and GABA) and NH_4^+ content in poplar roots, which are negatively correlated to NO_3^- uptake. Including trans-zeatin riboside (tZR), an active form of cytokin, in the nutrient solution reduces NO_3^- uptake in poplar saplings (Dluzniewska *et al.*, 2006).

2.4.3 Nitrogen Storage

Nitrogen storage in plant is crucial to support plant growth in the early growth after bud break, when roots N uptake conditions are sub-optimal (Millard, 1996). The N storage correlates to available N supply during growth season. The N availability increase in summer, as well as foliar urea application in autumn, can be used to build up N storage in young apple and poplar. In addition, they also are often used to increase the development of new growth in spring (Cheng *et al.*, 2004; Cheng and Fuchigami, 2002; Dong *et al.*, 2002; Dong *et al.*, 2004).

Generally, the sites of N storage by trees are restricted to specific organs and depend on leaf habit (Table 1). Deciduous species tend to store N in the wood and bark of root or trunk

(Millard and Grelet, 2010). Nitrogen is stored in plant as proteins and amino acids (Rennenberg *et al.*, 2010). For example, poplar trees initiated vegetative storage proteins (VSPs) accumulation in new shoots during new shoots development in spring, under high temperature and long days conditions (Tian *et al.*, 2005). VSPs accumulate in wood, bark and roots (Langheinrich, 1993) and the major VSPs in *Populus* are bark storage proteins (BSPs) (reviewed by Cooke and Weih, 2005). N allocation to storage is programmed seasonally and is, therefore, intimately linked to tree phenology (Millard and Grelet, 2010). Later in the season, the growth rate declines. In the fall, the growth of deciduous trees stops as day length and temperatures decrease, and the trees drop their leaves. Leaf proteins' N is transferred to bark storage proteins, stored over the winter, and then remobilized and used for growth in the next spring (Black *et al.*, 2001; Cooke and Weih, 2005). The absorption of N from senescing leaves varied from 40% in *Quercus suber* L. (Orgeas *et al.*, 2003) to 80% in *Populus tremula* (Keskitalo *et al.*, 2005). In addition, leaf N remobilization depends on plant age. Yuan and Chen (2010) showed that *Populus tremuloides* Michx. in boreal forest, standing of different ages about 7, 25, 85, and 139 years, leaf N remobilization is about 68.5%, 65.6%, 63.1%, and 58.4% of dry weight of leaf, respectively.

2.4.4 Nitrogen Remobilization

Bark storage proteins (BSP) degradation occurred considerably like temperature and day length of the situation spring condition before bud burst (Coleman *et al.*, 1993; Langheinrich, 1993). BSP are hydrolysed and amino acids are then translocated into flushing bud and leaves and used for *de novo* protein synthesis (Cooke and Weih, 2005). Several studies have shown that a peak of nitrogenous compounds and coupling sap flow velocity in the xylem sap have been attributed to the remobilized N transport during bud break (Frak *et al.*, 2002; Grassi *et al.*, 2003; Grassi *et al.*, 2002; Malaguti *et al.*, 2001). The peak of N concentration in xylem sap during bud break and leaf growth was attributed to N remobilization. The majority of nitrogenous compounds remobilization in xylem depends on plant species. In particular, above 90% of N compounds of the xylem spring sap of apple (*Malus domestica* Borks.) was recovered from amino acid, asparagine (Asn), aspartic (Asp) (Geisler-Lee *et al.*) glutamine (Gln) and glutamic (Glu) (Malaguti *et al.*, 2001). In walnut, arginin (Arg), citrulline (Cit), Glu and Asp always represented around 80% of total amino acid and amide N in xylem of walnut (*Juglans nigra* × *J. regia*) (Frak *et al.*, 2002). Gln and Asn are the major N compounds translocated by xylem in cherry (*Prunus avium* L.) (Millard *et al.*, 2006). In poplar, Millard *et al.* (2006) reported Gln as an important N compound translocated by xylem in poplar (*Populus trichocarpa* × *P. balsamifera*). Nitrogen mobilization from storage to new tissue depends on N uptake duration the previous year. The amount of N

remobilized from reserve to recovered in new growth of nectarine (*Prunus persica* var. nectarine) accounted 42% and 49% of total N uptake in early (May to mid July) and late (mid August to the beginning of October) previous season, respectively (Tagliavini *et al.*, 1999). In *Ligustrum ovalifolium* remobilizes about 55% of N assimilation in previous spring and raises to 68% of N assimilation during the previous autumn (Salaün *et al.*, 2005). Therefore, the recent N uptake in previous season is more efficiently used for support re-growth than that absorbed N of the earlier previous season.

As stated for early re-growth, there are two main N sources to sustain growth: remobilization of stored N and N uptake. Nitrogen mobilized from storage tissues to sustain spring growth was reported to account for 15% of total N found in new shoots in beech (*Fagus sylvatica* L.) (Dyckmans and Flessa, 2001), 46% in pear (*Pyrus communis* L.) (Tagliavini *et al.*, 1997) and up to 54% in walnut (*Juglans nigra* × *J. regia*) (Frak *et al.*, 2002). Nitrogen from remobilization was recovered in the growing leaves before any root uptake of N occurs, 7-18 days in cherry and 36 days in poplar (Grassi *et al.* 2002; Millard *et al.* 2006), while *Pinus sylvestris* L. and *Betula pendula* Roth. were clipped, root uptake contributed N for leaf growth immediately after bud break, concurrently with N remobilization (Millard *et al.*, 2001).

Nitrogen remobilization for new spring growth also depends on the current N supply and the amount of stored N remobilized. When no N was provided during re-growth, then all utilized N for support new growth was sustained by N remobilization. When adequate N was supplied during re-growth, N remobilization in *Ligustrum ovalifolium* was 15% lower than in unfertilized plants (Salaün *et al.*, 2005). In apple, when N was supplied during re-growth, N remobilization provided about 43% of the total N in trees with low N status before bud break. This N remobilization increased to 85–90% in trees with medium to high N status before bud break (Cheng and Fuchigami, 2002). Similar pattern has been found in beech (*Fagus sylvatica* L.) (Dyckmans and Flessa, 2001) and cherry (*Prunus avium* L.) (Grassi *et al.*, 2003). Therefore, N storage remobilization is the main N support to new growth and depends on quality of N storage. Additionally, the current N supply in spring affects the N status of the new growth.

2.4.5 Nitrogen Impact Plant Growth and Development

Nitrogen availability is necessary as it affects most physiological process of plant development. Increasing in the level of N nutrient increases shoot dry weight and number of bud set per plant. Furthermore, altered inorganic, amino acid and glucose in the xylem sap are also affected by N increasing (Grassi *et al.*, 2002). Number of studies undertakes experiments

on the effect of N availability on plants during growth period (late spring and summer). For examples; poplars (*Populus* spp.) include fast growth response to fertilization, especially N availability (van den Driessche *et al.*, 2008; Yin *et al.*, 2009); and the changes of N availability in poplars has an effect on several processes of plant growth such as light-saturated net photosynthesis, water-use efficiency and leaf area. These results change whole-plant architecture, secondary xylem formation, and carbon accumulation (Coleman *et al.*, 2004; Cooke *et al.*, 2005; Pitre *et al.*, 2007; Ripullone *et al.*, 2003; Ripullone *et al.*, 2004). Therefore, nitrate may play a role in plant growth and development.

The stored N mobilization and supply during re-growth are used to increase the quality of new growth. Dyckmans and Flessa (2001) shown that N supplied to beech (*Fagus sylvaticus* L.) the previous year increased carbon assimilation and whole plant dry weigh of re-growth. In addition, the N supplied the previous year induced an earlier leaves formation. These were complete 6 weeks after bud break with N supply, whereas no N supply show that leaves formation were not complete until 12 weeks. Total leaf area in apple, at the end of the re-growth period, increased curvilinear with the stored N remobilisation increases. Current N supply in the spring increased tree total leaf area only about 10% (Cheng and Fuchigami, 2002). The study of Dong *et al.* (2004) showed that when cuttings from poplar stock plant were grow in medium without N, the new biomass growth in the second year has a positive relationship with N content per cutting at the start of re-growth. When N was supplied to the cutting, total new biomass was significantly increased, but the strength of the relationship between the new growth and N content per cutting at the start of re-growth was significantly reduced. So biomass growth of new cutting was influenced by N supply in the second growth season.

However, the study of supplied nitrogen during last autumn and early spring when plants have no leaf is relatively rare, the researchers belief that during such periods plants can not uptake nitrogen. Amongst those few studies found that plants can uptake nitrogen even before bud break. For examples, Delaire (2005) in maple (*Acer pseudoplatanus*) and Ewer *et al.* (2001) in walnut (*Juglans regia* L.) during autumn and spring. They found that walnuts can uptake nitrate when soil temperature is high and such N uptake induces root pressure. The positive root pressure increases water content and refills embolism in xylem vessels during spring growth (Ameglio *et al.*, 2002; Ameglio *et al.*, 2001).

Table 2.1 : Selected Previous Studies of the contribution of nitrogen remobilization to the seasonal growth of trees

Leaf habit	Species	Tree age (years)	Main site of N storage	Proportion of N for new shoot growth remobilized from storage	Method	References
Deciduous broadleaf tree	<i>Acer pseudoplatanus</i>	4	Roots and stem	37–48% (\pm N)	¹⁵ N ^a	Millard and Proe 1991
		9		\approx 33%	¹⁵ N ^a	Millard 1994
	<i>Betula pendula</i>	4	Woody roots/stem	48%	¹⁵ N ^a	Millard <i>et al.</i> 2001
		4		37%	¹⁵ N ^a	Millard <i>et al.</i> 1998
	<i>Betula pubescens</i>	4	ND	50–54% (\pm N)	¹⁵ N ^a	Wendler and Millard 1996
		4		52–72% (competition with herbaceous spp.)	¹⁵ N ^b	Millett <i>et al.</i> 2005
	<i>Fraxinus excelsior</i>	4	ND	17–29%	¹⁵ N ^a	Millard 1993
	<i>Fagus sylvatica</i>	4	Stem and coarse roots	18%	¹⁵ N ^a	Dyckmans and Flessa 2001
	<i>Jugulans nigra</i> \times <i>regia</i>	3	Stem and coarse roots	54%	¹⁵ N ^a	Frak <i>et al.</i> 2002
	<i>Jugulans regia</i>	9	Mature	60%	¹⁴ N/budget	Weinbaum and Van Kessel 1998
				41–72% (time)	¹⁴ N/budget	Deng <i>et al.</i> 1989
	<i>Malus domestica</i>	4	ND	61–87% (\pm N)	¹⁵ N ^b	Guak <i>et al.</i> 2003
		5	ND	87% (spur leaves) 52% (shoot leaves)	¹⁵ N ^b	Neilsen <i>et al.</i> 1997
		3	Stem	28–34%	¹⁵ N ^b	Millard and Thomson 1989
		2	Stem	18–54% (\pm N)	¹⁵ N ^b	Millard and Neilsen 1989
	<i>Populus spp.</i>	Various	BSP	ND	–	Cooke and Weih 2005
	<i>Prunus avium</i>	2	ND	14–26% (\pm N previous year)	¹⁵ N ^b	Grassi <i>et al.</i> 2002
	<i>Prunus persica</i>	2	ND	72–80% (different varieties)	¹⁵ N ^b	Policarpo <i>et al.</i> 2002
	<i>Pyrus communis</i>	3	ND	47%	¹⁵ N ^b	Quartieri <i>et al.</i> 2002
	<i>Quercus robur</i>	1	Stems/large roots	80–100% (\pm N)	¹⁵ N ^a	Vizoso <i>et al.</i> 2008
<i>Quercus pyrenaica</i>	2–4	Woody tissues	7–82% (different years)	Budget	Silla and Escudero 2003	
<i>Sorbus aucuparia</i>	4	Woody roots/stem	32%	¹⁵ N ^a	Millard <i>et al.</i> 2001	

^a¹⁵N applied the year before sampling, so only remobilization of N taken up the previous year quantified

^b¹⁵N applied the year of sampling, so remobilization of all N quantified

ND, not determined

Source: Adapted from Millard and Grelet, (2010)

2.5 Justification of Hypothesis and Objectives

Growth and development of young poplars showed that poplar was planted during early first spring (Fig 2.6.). From summer to autumn, poplar exhibits carbon assimilation supporting tissue growth and carbon storage. Then, during autumn and winter, leaves fall down and dormancy is set up. At this stage, the one-year-old poplar contains a main stem, axillary buds, and an apical bud. Generally, early in the following spring, axillary buds broke and new shoots grow, becoming branches, early than the breaking of apical bud. The new branches were a “*sink*” site requiring biochemical compounds such as N and NSC reserve, previously stored to support their growth and development. Therefore, the biochemical compounds were remobilized. Carbon remobilization was used to support branch development until the branches have adequate leaves to perform positive photosynthetic carbon assimilation.

In addition, axillary bud break and leaf growth initiates transpiration, water and mineral uptake, and leaf biochemical metabolism. Then, the new branches change from “*sink*” to “*source*” sites, produce the new biochemical compounds such as amino acid and carbohydrate. The new biochemical compounds and biochemical compounds stored from previous years were utilized to support new roots development, new cambium, and especially apical bud break and growth. Accordingly, the development of new shoots originated from the auxiliary buds during early spring, have noticeable effect on the early phase of growth and development of new roots, new cambium, apical bud break, and the new shoots originated from apical buds.

In deciduous plant, N and carbon have a major role in plant re-growth. In early stage of the re-growth, used carbon comes from storage mobilization, until adequate leaf developed sufficient photosynthetic activity to support net carbon assimilation (Dyckmans *et al.*, 2000). Nitrogen comes from N storage mobilization and root uptake. Nitrogen storage is substantially used for re-growth of new shoot, while N root uptake will increase the development of re-growth such as increased leaf area, N content of new shoot, carbon assimilation, and whole plant dry weight. Poplar is a fast growing species and therefore may require more N to support initial spring growth than that available from storage (Dong *et al.*, 2004). Several studies showed that the changes of N availability in poplars during growth season have an effect on processes of plant growth and physiology (Cooke *et al.*, 2005; Pitre *et al.*, 2007; Ripullone *et al.*, 2003; Ripullone *et al.*, 2004).

However, there are relatively few studies have focused on supplied N before bud break, e.g. as reported that apple (Dong *et al.*, 2001), walnut (*Juglans regia* L.) (Ewer *et al.*, 2001), and maple (*Acer pseudoplatanus*) (Delaire, 2005) Those studies found that plants can uptake N

even before bud break. Poplar was used in all experiments of this thesis because it has never reported about the uptake nitrogen activity before bud break. Therefore, in the first stage, this study wants to find whether poplar uptake nitrogen before bud break. In addition to the role of N uptake before bud break which is neglected in previous studies, in the second stage, this study wants to find the effect of nitrogen uptake before bud break on plant growth and development.

A hypothesis for this study is the physicochemical characteristics of the root environment involved in the development of axillary buds break and new shoots. Emphasis was placed on the nitrogen during the critical phase of development. A well defined experimental protocol was then used to discriminate the potential effect on N uptake before bud break with the restart of mineral uptake after bud break. This protocol has been implemented with different plant structures. Their choice was deliberately limited to young plants. Three series of experiments were conducted in a coordinated manner: the one year old scion (i), the young stump (ii), and the system then reiterated associated the “stump” and the “scion” (iii). They simulate the young poplar involved in the production of biomass by using of short rotation coppice.

The experimental base is common to all tests performed during this thesis. It is to study plants in a controlled environment and with three terms of N supply:

- (i) Without N supply
- (ii) With a limited N supply, prior to bud break
- (iii) With continuous N supply

The parameters used to characterize the quality of the bud affect the dynamics of hydromineral absorption, the dynamics of growth and bud break, xylem sap pressure from before bud break, sap flow during bud break, and the final compositions of the tissues, in particular, NSC and N. The analysis of each of these parameters, as well as a global integration is performed in order to account for the variation of the quality of re-growth during bud break and to propose explanations with some of the underlying physiological mechanisms. This study purposes is to fill such gap; therefore the objectives are:

- 1) To quantify N uptake before bud break in poplar (*Populus tremula* × *Populus alba*, clone INRA 717-1B4).
- 2) To discriminate if extended N uptake before bud break may have a significant effect on the development of re-growth.

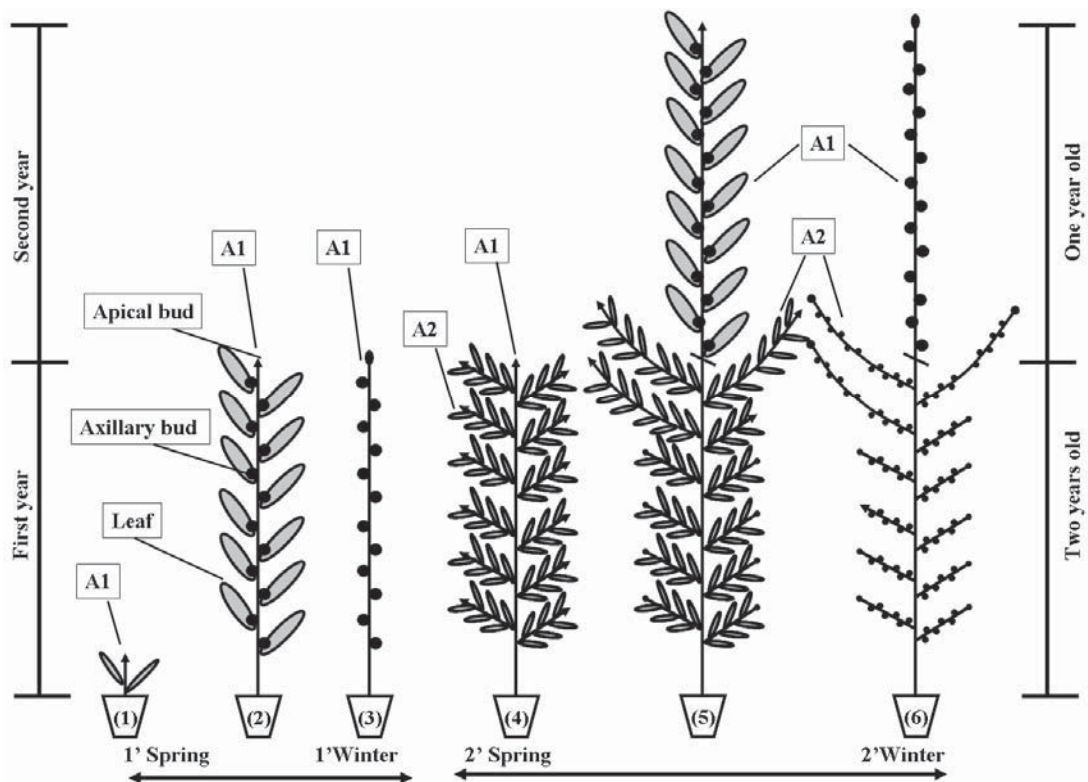

Fig. 2.6 : Scheme architecture of the two-years-old poplar. Poplar was propagated during early first spring (1). Poplar was grown until it produced leaves, axillary buds, and apical buds on main stem during summer to autumn (2). Leaves fell down and dormancy occurs during autumn to winter. Poplar showed axillary buds and an apical bud on main stem (3). During early second spring, axillary buds broke and new shoots become branches early than the breaking of apical buds. The new branches were a “sink” site that requires some bio-chemicals such as N compounds and NSC reserve, previously year stored to support their growth and development (4). Apical buds of branches were broken when the first flush of the branches were changed from “sink” to “source” sites, that could produce biochemicals to support apical bud break and growth of main stem. After that, the apical bud of top branch developed the second and third flush, respectively during summer to autumn (5). Leaves fall down during the second winter. The one-year-old main stem poplar contains axillary buds and an apical bud. While the two-years-old main stem poplar contains axillary buds and the apical buds of branches (6).

Chapter 3: Experiments

3.1 Experiment I:

Nitrogen Supply before Bud Break Strongly Impacts Spring Development of One-Year Scion Poplar

3.1.1 Introduction

Non structure carbon (NSC) and nitrogen (N) storage is an essential of deciduous tree for survival during winter and for new growth in spring. Stored carbon will be used until plants have adequate leaves and photosynthetic capacity in order to support net carbon assimilation. Non structure carbon reserve functions are mainly covered by starch, degraded in soluble carbohydrates during the dormant season to maintain respiration, and in spring during bud flush. Most studies on mobilized and stored NSC suggest that root is the main storage tissue of plants (Landhäusser and Lieffers, 2003; Regier *et al.*, 2010; Wong *et al.*, 2003). Nitrogen storage occurs principally in autumn within perennial tissues such as roots and stems (Marmann *et al.*, 1997; Millard, 1996; Tagliavini *et al.*, 1998) in the forms of bark, and wood storage proteins and amino acids (Cooke and Weih, 2005; Tian *et al.*, 2005). During bud break, xylem sap is proposed as the principal pathway for NSC and N distribution. Both NSC and N compounds are transported from exporting tissue storage to sinks (Bonhomme *et al.*, 2009; Frak *et al.*, 2002; Guérin *et al.*, 2007; Millard *et al.*, 2006).

Several studies suggested that N availability increase during spring induces the quality of new growth such as an increase of leaf area in apple (Cheng and Fuchigami, 2002), and an increase re-growth biomass in poplar cutting (Dong *et al.*, 2004). In particular, studies in poplars (*Populus* spp.) found that the biomass per unit of land area and short-rotation coppice is more intensively produced when plants are supplied with nitrogen (Aylott *et al.*, 2008; Karp and Shield, 2008). The quality of new growth also extends to the fast growth of plants in response to fertilization, especially that of N (van den Driessche *et al.*, 2008; Yin *et al.*, 2009). In addition, it was found that increased N supply during growth season influence on growth and development of poplar, thus affecting several plant growth processes, such as light-saturated net photosynthesis and leaf area. The whole plant architecture, secondary xylem formation, N and carbon storage in tissue and biomass accumulation are also affected (Cooke *et al.*, 2005; Pitre *et al.*, 2007; Ripullone *et al.*, 2003; Ripullone *et al.*, 2004).

Storage N remobilization occurring before roots can uptake was found in several trees such as *Malus domestica* (Guak *et al.*, 2003; Malaguti *et al.*, 2001), *Prunus avium* (Grassi *et al.*, 2003; Millard *et al.*, 2006) and *Pyrus communis* (Tagliavini *et al.*, 1997). While walnut (*Juglans niger* × *J. regia*), *Pinus sylvestris* L. and *Betula pendula* Roth. were clipped, root uptake contributed to leaf growth immediately after bud break, concurrently with remobilization (Frak *et al.*, 2002; Malaguti *et al.*, 2001). In addition, the work of Dong *et al.* (2001) revealed that one year apple trees uptake nitrate before bud break when soil temperature is between 12°C and 20°C.

However, few studies have focused on an effect of N uptake before bud break on the development of new growth. This study purposes to fulfill such gap, therefore, objectives are: to quantify the N uptake before bud break in poplars (*Populus tremula* × *Populus alba*, clone INRA 717-1B4), and extent to whether the N uptake before bud break has any significant effect on the N and NSC reserve and the quality of new growth. The experimental base is common to all tests. Plants were placed in a controlled environment, under three terms of N supply: (i) without N, (ii) with a limited use prior to bud break, and (iii) with continuous N supply. The parameters used to test the hypothesis are the dynamics of mineral absorption, dynamics of growth and bud break, xylem sap pressure from before bud break, sap flow during the bud break, and the final compositions of the tissues with a focus on NSC and N. Analysis of each parameters, and global integration was made to approach the variation in the quality of re-growth at bud break and to propose explanations related to some of the underlying physiological mechanisms.

3.1.2 Material and Method

3.1.2.1 Plant Material

The one-year scion poplar (*Populus tremula* × *Populus alba*, clone INRA 717-1B4) originating from *ex vitro* micro-cuttings (Beaujard *et al.*, 2002) were used as the starting material. The poplar cuttings were cultivated in cylindrical containers (diameter × height = 0.20 × 0.30 m) on March 2008. Containers were filled with perlite and covered with a 1 cm thick layer of waterproof silex (Mursain®) in order to limit evaporation and algae development. Then, eighteen plants were sourced into three drip-irrigated recirculating nutrient solution systems. The six plants per solution recirculation system was automatic drip-irrigated with the 80 liters nutrient solution that was recirculated for 1 hour, six times a day, to ensure the non-limiting supplied of water and nutrients. The composition of nutrients with nitrate was (mmol.L⁻¹) 1.82 NO₃⁻, 0.19 H₂PO₄⁻, 0.24 SO₄²⁻, 1.00 K⁺, 0.39 Ca²⁺, 0.355 Mg²⁺, micro elements

(Kanieltra® 0.2%). Such nutrients were renewed every week until 3 September 2008. In winter, the nutrient solution without nitrate was (mmol.L^{-1}) $0.19 \text{ H}_2\text{PO}_4^-$, 0.665 SO_4^{2-} , 0.97 Cl^- , 1.00 K^+ , 0.39 Ca^{2+} , 0.355 Mg^{2+} and micro elements (Kanieltra® 0.2%). It was renewed every week until the experiment started.

The experiment was started on 3 March 2009 (62 day of year 2009) in greenhouse which controlled temperature at 18-20 °C. The start experiment sampled and harvested one plant per solution recirculation system (total 3 plants). This data set was named as 'Start'. Then, poplar trees were separated into three treatments. Each treatment contains five plants placed in a solution recirculation system. The first treatment is a 'Control', without nitrate supply. The second, 'N-Pulse', was supplied with nitrate for seven days before bud break and was then monitored without nitrate supply for the rest period of experiment. The last treatment, 'N-Supply', was supply with nitrate throughout the whole experimental period.

3.1.2.2 Mineral Uptake

Nitrogen and mineral uptake of plants were measured by indirect method. The net mineral uptake was calculated using the temporal variation of mineral quantity between initial and final ion content in nutrient solution (Beaujard and Hunault, 1996). In this experiment, nutrient solutions were collected by sampling 0.06 liter of nutrient solution, and the volume of tank was measured two times after watering for one hour, at 9.00 and 17.00. Such solution samples were analyzed on HPLC Metrohm Bioscan system (Metrohm France-91942 Courtaboeuf - France) with Metrosep C2 250 \times 4.0 mm column for cations (K^+ , Ca^{2+} , Mg^{2+} and NH_4^+) and Metrosep A SUPP7 250 \times 4.0 mm column for anions (NO_3^- , NO_2^- , HPO_4^{3-} , SO_4^{2-} and Cl^-). Then, plants nutrient uptake was estimated using the model of Beaujard and Hunault (1996) (Appendix 6.1).

3.1.2.3 Root Pressure

Root pressure was measured from the start of experiment until bud break. Root pressure was measured by the pressure transducer (Model 26PC Series Pressure Sensors, Honeywell LTD, USA.), which was connected to data loggers (DL2e; Delta-T Devices, Cambridge, U.K.) in order to record data. Stainless steel hypodermic needles were used and deionize water ensure connection between pressure censor and sap xylem (Beaujard, unpublished; Clearwater *et al.*, 2007) (Appendix 6.2).

3.1.2.4 Sap Flow

Sap flow was measured from the start until the end experiment in order to investigate the sap flow pattern. Sap flow was measured by the heat balance method, which is based on the energy balance of a stem segment to heat energy supplied by external annular heater (Sakuratani 1984; Baker and Van Bavel 1987; Valancogne *et al* 1989) (Appendix 6.3).

3.1.2.5 Plant Harvest and Architecture

Plants were harvested two times: at the start experiment, 3 March 2009 (61 day of year 2009) and 15 days after bud break, 8 April 2009 (98 day of year 2009). Plant samples were taken from different organs (i.e., stem, root, leaf) and at different positions. Then, three plants were sampled before experiment (start), and five plants per treatment, 15 days after bud break. The main stem samples were taken from three parts: base stem (height 20 cm), middle stem, and top stem (measure at 20 cm under the end of main stem). After that, sample stems were measured for diameters, length, and weight before and after split off bark and wood. Roots were separated into two groups: fine root (diameter ≤ 2 mm), and larger ones (diameter > 2 mm). At the end of the experiment, samples of new axillary shoots (NS) were harvested from each scion at the 5th, 15th, and 30th from the apex respectively (Fig. 3.1). Then, the new leaf numbers 1, 3, 5, and 7 of such new shoots were taken from the base of new shoots.

All samples were placed in liquid nitrogen to stop enzymatic activity and stored at -75°C, and kept until freeze-dried at -20°C. The dry weight and relative water content of samples was measured after freeze-drying. They were then grounded to fine powder, and stored at room temperature. The remaining compartment tissues were dried with hot air oven at 75°C and dry weight was measured.

Plant architecture data was collected two times: at the start experiment before the application treatments, 3 March 2009 (61 day of year 2009); and 15 days after bud break, 8 April 2009 (98 day of year 2009). Three parts of main stem of plants were collected for the length diameter of base stem (height 10 cm), middle stem, and top stem (measure at 10 cm lower the end of main stem), respectively. Plants characteristics were investigated: time and number of bud break and number of leaves. Time and number of bud break was collected every day after the experiment start. Bud break was determined as the emergence of the first leaf the bud scales. Leaves were collected as described above and leaf area was measured, 15 days after bud break, using a leaf area meter (LI-30004 Portable Area Meter, LI-Cor,inc.)

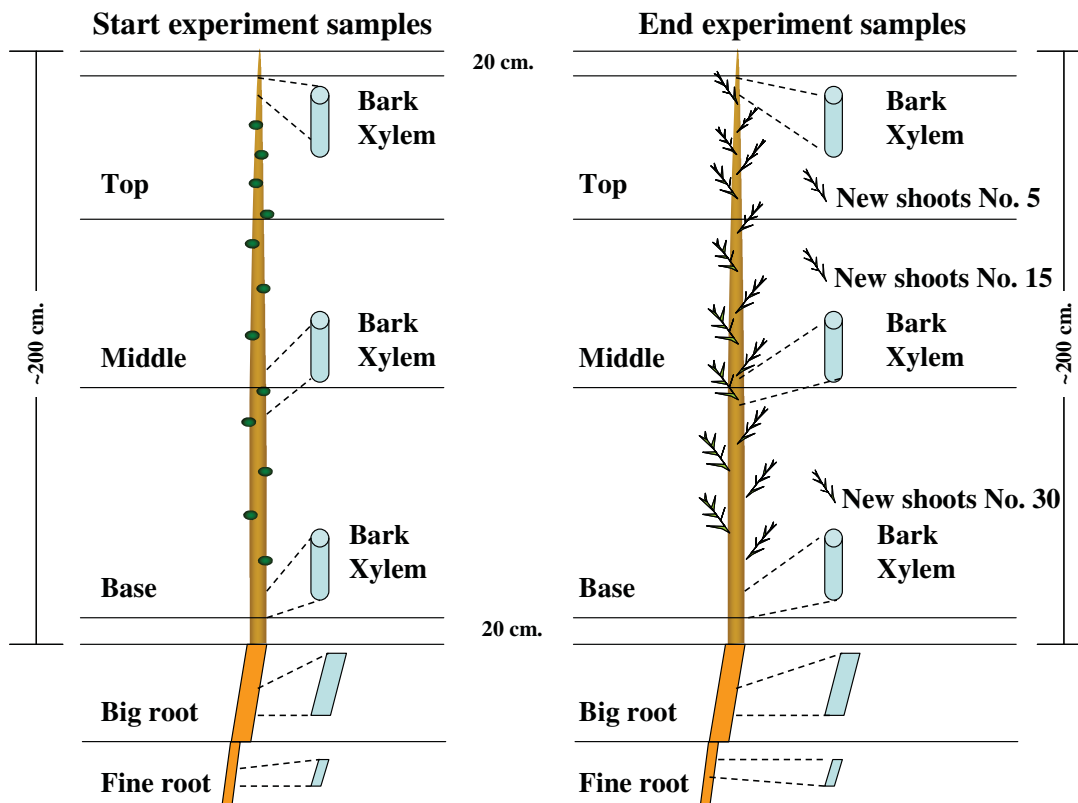

Fig. 3.1 : Scheme of plant samples during the start (*Start*) and the end (Control, N-Pulse, and N-Supply) experiment 2009. Plant samples were taken from different organs (i.e., stem, root, leaf) and at different positions. The main stem samples were taken from three parts: base stem (height 20 cm), middle stem, and top stem (measure at 20 cm under the end of main stem). After that, sample stems were measured for diameters, length, and weight before and after split off bark and wood. Roots were separated into two groups: fine root (diameter ≤ 2 mm), and larger ones (diameter > 2 mm). The new shoot samples were taken from new shoots numbers 5, 15, and 30 from the apex respectively.

3.1.2.6 Nitrogen Analysis

Nitrogen was analyzed from five sample parts: fine root, big root, stem bark, stem xylem, and new shoot. Then, aliquots of 2-3 mg milled materials were weighed into tin cartouches (Hekatech, Wegberg, Germany) and determined by the Elemental analyzer EA1108 (Carlo Erba Strumentazione, Rodano, Milan, Italy). Atropine (4.816% N; Carlo Erba Strumentazione, Rodano) was used as a standard (Appendix 6.4).

Nitrogen Mobilization

Nitrogen mobilization to new growth in spring depends on the current N supply and on the amount of stored N remobilization. When no N is provided during the re-growth period, all N comes from stored N remobilization (*Control*). However, if plants are supplied with exogenous N before or during bud break, then the new growth of plants is supported by both stored N and N uptake (*N-Pulse* and *N-Supply*).

The relative N net flow (NNF) of each compartment tissue used to support new auxiliary shoot growth during the experiments was estimated by the differences in N content of each compartment tissue before and after bud break. To consider variations of the initial size between plants at the start, relative NNF of each compartment was determined in two steps. First, N content in each compartment of tested plants (*Control*, *N-Pulse*, and *N-Supply*) at the start before the application treatments of the experiment was calculated under the assumption that N proportions in tissue compartments would be the same as those determined for the harvested plants at the start of the experiment, assume that young trees were grown in the same environmental conditions (Eq.1). In the second step, the relative NNF ($N_{\text{net_flow}(n)}$) of each compartment before bud break used to support new shoot growth after bud break was calculated by computerizing the N content of each compartment at the start (reconstruction) and at the end of the experiment (Eq. 2) (Appendix 6.5).

The equation for N content estimation in tissues at the start of *Control*, *N-Pulse*, and *N-Supply* experiments is as follows:

$$N_{\text{Start}(n)} = \frac{C_{\text{Ref}(n)} \cdot DW_{\text{Ref}(n)}}{\sum_1^p (C_{\text{Ref}(n)} \cdot DW_{\text{Ref}(n)})} \cdot \left(\sum_1^p (C_{\text{End}(n)} \cdot DW_{\text{End}(n)}) - N_{\text{up}} \right) \quad (1)$$

The N net flow of each compartment tissue estimated according the equation below:

$$\% N_{\text{net_flow}(n)} = \left(1 - \frac{N_{\text{End}(n)}}{N_{\text{Start}(n)}} \right) \times 100 \quad (2)$$

where :

- $N_{\text{net_flow}(n)}$ is the relative NNF of each compartment tissue (% of stored N in tissue of previous year) during the experiment period. If the calculated value of NNF is positive, it suggests that NNF indicates N export from a compartment to new shoot whereas a negative value indicates an N load (import) of a compartment from other compartment and/or N uptake.
- $N_{\text{End}(n)}$ is the N content (g) of each compartment tissue after bud break.
- $N_{\text{Start}(n)}$ is the estimated N content (g) of each compartment tissue before bud break
- N_{up} is the N uptake (g) during experiment period.
- $C_{\text{Ref}(n)}$ is the N content ($\text{g} \cdot \text{g}^{-1}$ DW of tissue) of each compartment tissue before bud break.
- $C_{\text{End}(n)}$ is the N content ($\text{g} \cdot \text{g}^{-1}$ DW of tissue) of each compartment tissue after bud break.
- $DW_{\text{Ref}(n)}$ is the total dry weight (g) of each compartment tissue before bud break
- $DW_{\text{End}(n)}$ is the total dry weight (g) of each compartment tissue after bud break.
- (n) is the component tissues such as stem xylem, stem bark, big root, and fine root.

3.1.2.7 Non Structural Carbon Analysis

Carbohydrates were extracted from dry matter of fine root, big root, stem bark and stem xylem samples (30-50 mg) with 1.0 ml 80% ethanol at 80°C for 20 minutes, then mixed and centrifuged at 12,000 rpm for 10 minutes. The supernatant was collected and pellet was re-extracted three times as above. All supernatants were combined supernatant together. The supernatant and pellet were analyzed to find soluble sugar and starch, respectively (Appendix 6.6).

Estimation of Non Structural Carbon Remobilization

The Non structural carbon (NSC) of tissues was estimated as the sum of soluble sugar and starch. The NSC of tissues before bud break is generally used to support respiration and new growth after bud break (Barbaroux *et al.*, 2003; Landhäusser and Lieffers, 2003; Wong *et al.*, 2003). Estimating the relative NSC net flow mobilized to support respiration and new growth during the experiments was led by two steps. First, NSC in tissue compartments, at the start of experiments, was estimated based on the NSC found in tissue compartment at the end of experiment. This value was calculated under assumptions that the ratio of the NSC content (g) and the structural weigh matter (g) of a plant tissue at the start of experiment would be the same that a plant in test if it was involved in the same environmental conditions. In addition, small increase the structure weigh matter during experiment period is feasible but is assumed here insignificant (Eq. 3). Second, NSC remobilization was calculated by comparing NSC of all compartment tissues at the start (estimation) and at the end of experiments (Eq. 4) (Appendix 6.7).

An equation for estimating the NSC suggested is:

$$X_{start(n)} = \left(\frac{C_{ref(n)}}{1 - C_{ref(n)}} \right) \times (DW_{end(n)} \times (1 - C_{end(n)})) \quad (3)$$

The NSC remobilization before bud breaks, used to support respiration and new shoot growth after bud break during experiment, was estimated as the difference between NSC of each compartment before and after bud break. The estimated NSC remobilization equation suggested is:

$$\%X_{use(n)} = \left(1 - \frac{X_{end(n)}}{X_{start(n)}} \right) \times 100 \quad (4)$$

where :

- $C_{ref(n)}$ is the NSC content ($g \cdot g^{-1}$ DW of tissue) before bud break at the start of experiment
- $C_{end(n)}$ is the NSC content ($g \cdot g^{-1}$ DW of tissue) after bud break at the end of experiment.
- $DW_{ref(n)}$ is the total dry weight (g) before bud break at the start of experiment.

- $DW_{end(n)}$ is the total dry weight (g) after bud break at the end of experiment.
- $X_{start(n)}$ is the total estimate NSC (g) before bud break at the start of experiment.
- $X_{end(n)}$ is the total NSC (g) after bud break at the end of experiment.
- $X_{use(n)}$ is the relative of NSC remobilization of each compartment tissue during the experiment period (% of stored NSC previous year in tissue). If the calculated value of NSC remobilization is positive, it suggests that NSC indicates NSC used for respiration and exports from a compartment to new growths whereas a negative value indicates a NSC load of a compartment from other compartment tissues.
- (n) is the tissue component such as stem xylem, stem bark, big root, and fine root.

3.1.2.8 Data Analysis

Data was analyzed as a completely randomized design with the level of N treatments. All data were subjected to variance analysis to determine the significance of difference between treatments. Differences between treatments were assessed by Duncan's multiple-comparison test at the 0.05 level of probability. Mineral uptake of plant was interpreted by using mean. All statistical analyses in this study were performed by using the Statistical Analysis System program (SAS).

3.1.3 Results

3.1.3.1 Environments Control

This experiment undertook in a greenhouse, with controlled temperature, under natural light. One day before the experiment starts, temperature inside greenhouse was reset as spring temperature. The temperature in the greenhouse (Fig.3.2a) and nutrient solution in tank (Fig 3.2b) was increased average from 8.6°C to 18.6°C. The substrate temperature, around roots in the cylindrical containers, was increased average from 8.2°C to 18.1°C (Fig 3.2c). Between such temperature ranges, roots could be easily uptake nutrients, as it was confirmed by the studies in apple (Dong *et al.*, 2001) and walnut (Ewers *et al.*, 2001).

3.1.3.2 Architecture before Start Experiment

Architecture of one-year scion poplar before experiment start showed that the diameter, length, and volume of plant harvested at start experiment (*Start*) were slightly smaller than *Control*, *N-Pulse*, and *N-Supply*. Concerning the three treatments (*Control*, *N-Pulse*, and *N-Supply*), the diameter, length, and volume were similar. The average value of diameter base, diameter middle, diameter top, length and volume were 1.56 cm, 1cm, 0.29 cm, 191.5 cm and 160.2 cm³, respectively (Table 3.1).

Table 3.1 : Diameter length and volume of one-year scion poplar of *Start*, *Control*, *N-Pulse*, and *N-Supply* treatments before start experiment.

	Diameter			Length (cm)	Volume (cm ³)
	Base (cm)	Middle (cm)	Top (cm)		
<i>Start</i>	1.42 ± 0.04 b	0.91 ± 0.05 b	0.28 ± 0.01 a	173.3 ± 9.6 b	119.7 ± 13.2 b
<i>Control</i>	1.59 ± 0.06 a	0.98 ± 0.03 a	0.30 ± 0.02 a	192.8 ± 8.6 a	161.6 ± 14.4 a
<i>N-Pulse</i>	1.57 ± 0.10 a	1.01 ± 0.06 a	0.30 ± 0.03 a	187.1 ± 9.9 a	159.6 ± 25.4 a
<i>N-Supply</i>	1.54 ± 0.07 a	1.00 ± 0.03 a	0.28 ± 0.01 a	194.7 ± 8.7 a	159.3 ± 10.5 a
Pr > F	*	*	ns	*	*

Data are means ± SD of five plants per treatment

^{ns} non significant

*significant (P<0.05)

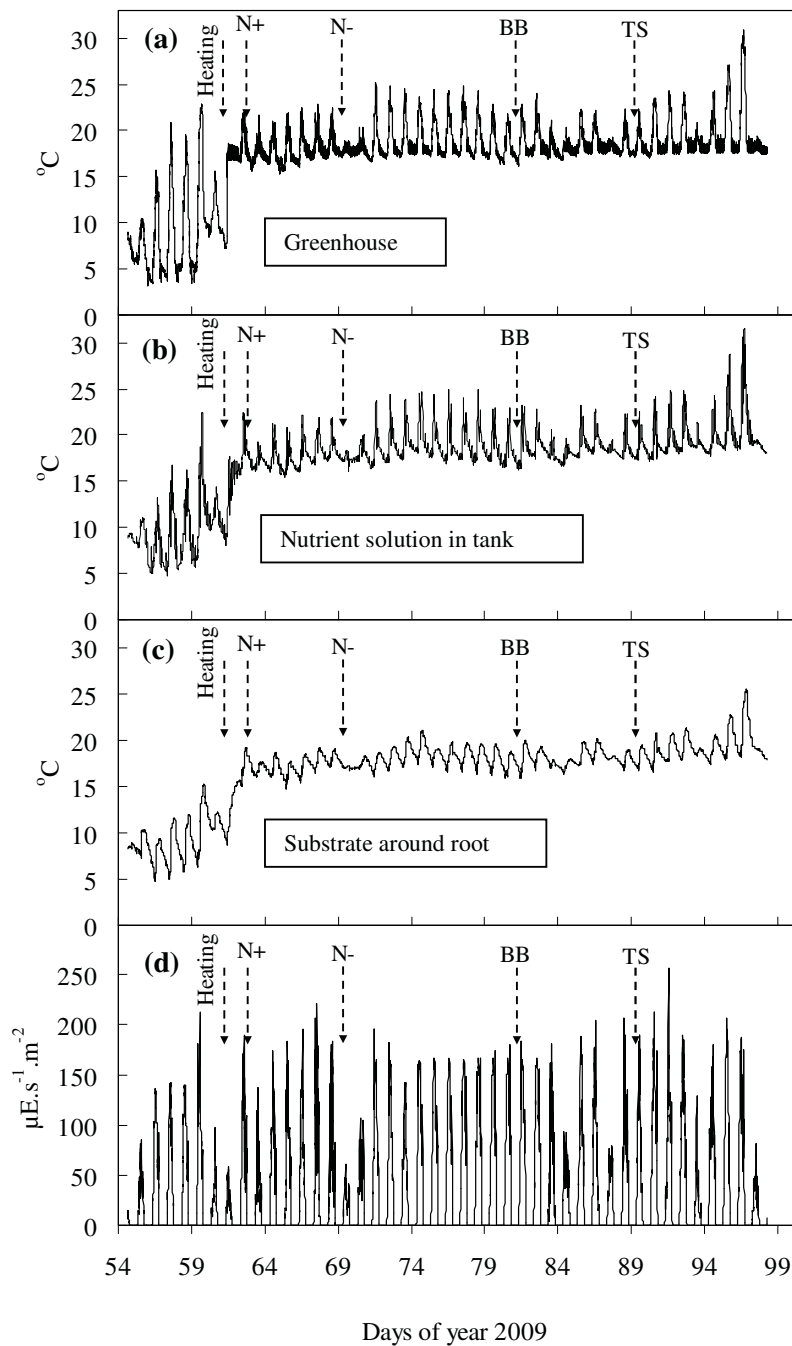

Fig. 3.2 : Environment conditions during experiment period 2009. Temperature of greenhouse (a), temperature of nutrient solution in tank (b), substrate temperature around root in cylindrical containers (c), and light intensity of greenhouse (d). The arrows represent the temperature increasing in greenhouse, and experiment starts, with nitrate supplying solution for *N-Pulse* and *N-supply* treatments (N+), first time change solution to stop nitrate supply in *N-Pulse* treatment (-N), bud break period (BB), and transpiration start (TS), respectively.

3.1.3.3 Bud Break

The stages of bud break development are shown in Fig. 3.3 (Stage A-F). Axillary Bud break, in this experiment, was determined when bud developed to the Stage C, when the first leaf emerges from the scales.

Profile of axillary bud break in the one-year scion poplar showed that number of bud break was not significantly different between *Control*, *N-Pulse*, and *N-Supply*. The numbers of bud breaking under *Control*, *N-Pulse*, and *N-Supply* conditions within 3-4 days was 44, 44, and 46 buds, respectively. The timing of 50% of bud break was the same in all treatments (Fig.3.4).

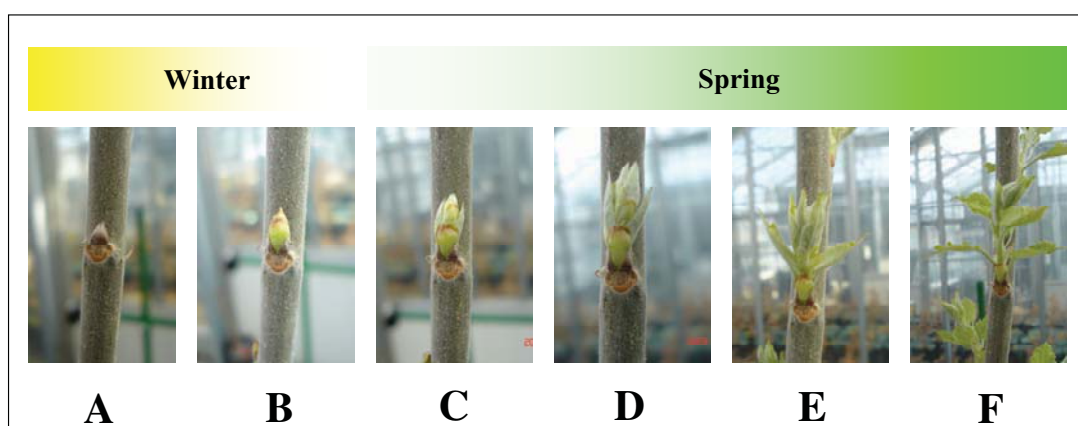

Fig. 3.3 : Axillary bud break development stages A-F of the one-year scion poplar. Descriptions and illustrations of different stages defined in the bud of a bud poplar sycamore.

Stage A: Bud at rest

Stage B: Opening of the first bud scale

Stage C: Bud break

Stage D: Small leaf internal lengthening: about 50%

Stage E: Small leaf internal lengthening: about 100%

Stage F: Leaves appear.

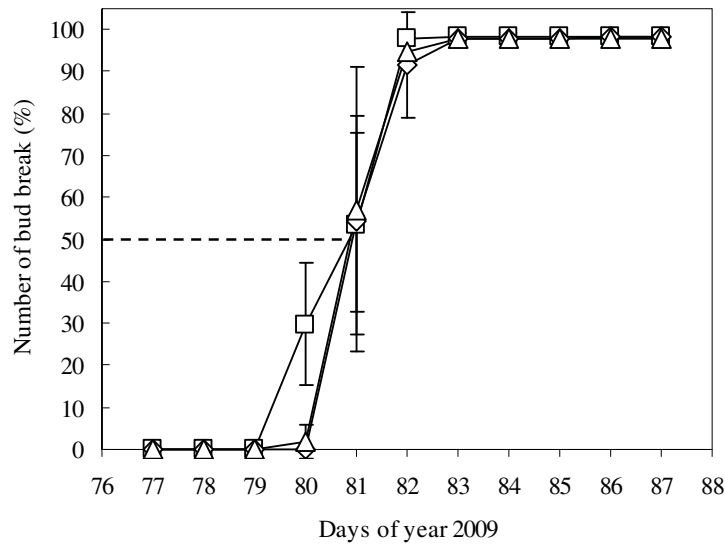

Fig. 3.4 : Timing of axillary bud break (Stage C) during experiment period 2009 in *Control* (□), *N-Pulse* (◇), and *N-supply* (Δ) treatments. Values are means \pm SD 5 plants.

3.1.3.4 Nitrogen Uptake

The dynamic curves of N uptake showed that poplars can uptake nitrate before bud break with a significant effect (Fig.3.5). The results of *N-Pulse* and *N-Supply* treatments confirm the hypothesis that N uptake was found before bud break at about $0.30 \text{ g.plant}^{-1}$ for *N-Pulse*. In case of *N-Supply*, nitrogen uptake before bud break was $0.39 \text{ g.plant}^{-1}$ and *N-Supply* exhibits another drastic increase in N uptake when leaf area was increased. The amount of nitrate taken up at the end of the experiment by trees from the *N-Supply* treatment amounted to $0.81 \text{ g.plant}^{-1}$.

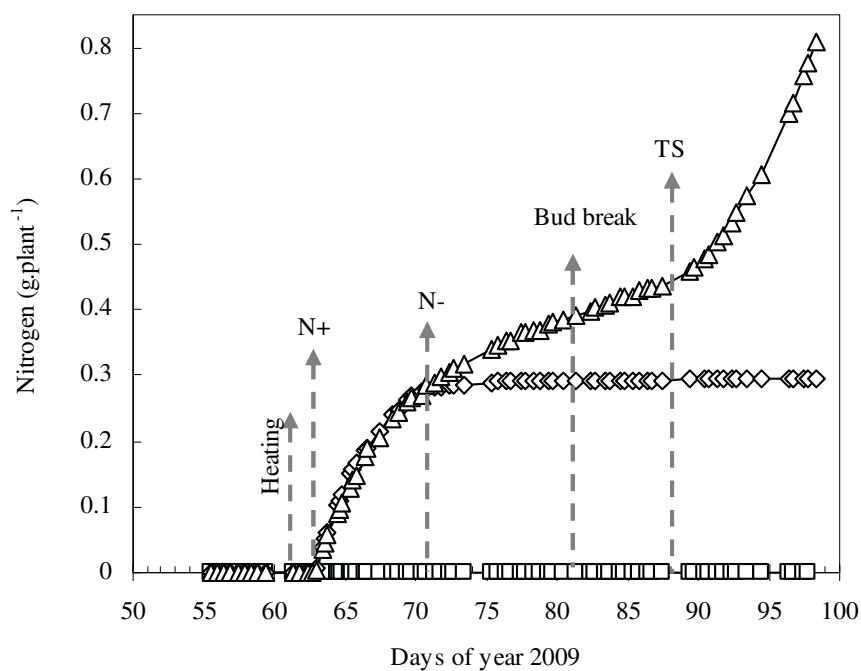

Fig. 3.5 : Cumulated nitrogen uptake (g.plant^{-1}) during the experiment period 2009 for *Control* (\square), *N-Pulse* (\diamond), and *N-Supply* (Δ) treatments. The arrows represent heating start of the greenhouse, start of nitrate supply for *N-Pulse* and *N-supply* treatments (N+), end of nitrate supply for *N-Pulse* treatment (-N), bud break period (Bud break), and transpiration start (TS), respectively.

3.1.3.5 Root Pressure

Root pressures of Control treatment remain unchanged during the whole experiment. It was almost equal to zero. Plants with N supplying before bud break induced root pressure. Results of *N-Pulse* and *N-Supply* treatments showed that root pressure dramatically increased (+ 200 kPa) after N supply and then remain stable for a week. However, during the second week, root pressure reached a peak and then decreases dramatically to the same level as *Control* before bud break (Fig. 3.6).

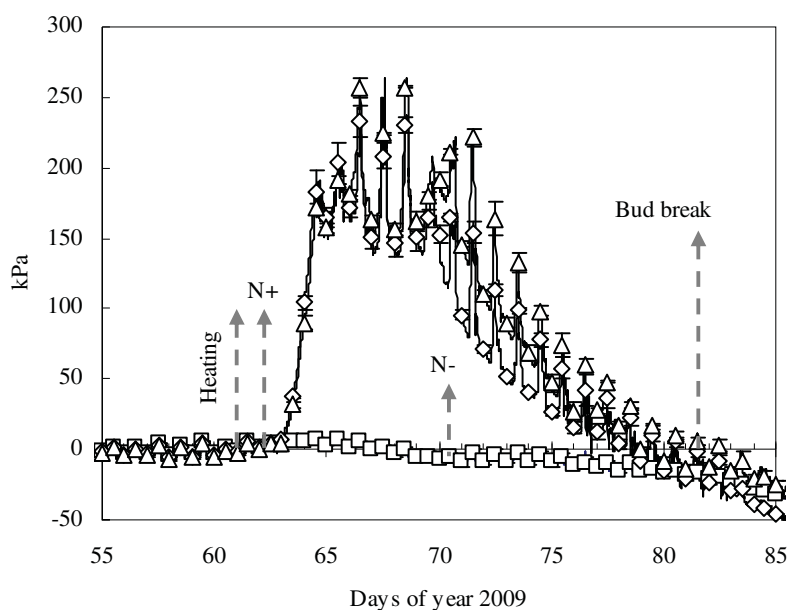

Fig. 3.6 : Root pressure (kPa) during experimentations period 2009 for *Control* (\square), *N-Pulse* (\diamond), and *N-Supply* (Δ) treatments. The arrows represent the heating in greenhouse, beginning of nitrate supply for *N-Pulse* and *N-supply* treatments (N+), end of nitrate supply for *N-Pulse* treatment (-N), and bud break period (Bud break), respectively. Values are means \pm SD of 3 plants.

3.1.3.6 Sap Flow

During early bud break, water transpiration could not be measured by the heat balance method according to the whole leaf area was small and low transpiration was found. After that, for 7-8 days, leaf area was increased then sap flow could be measured. Therefore, sap flow of the one-year scion poplar was positively correlated with the leaf area, and it also depended on the changes of light density (Fig. 3.7a). After bud break 15 days, the sap flow of *N-Supply* was increased higher than *N-Pulse* and *Control* by 39 and 32 percent, respectively (Fig. 3.7b).

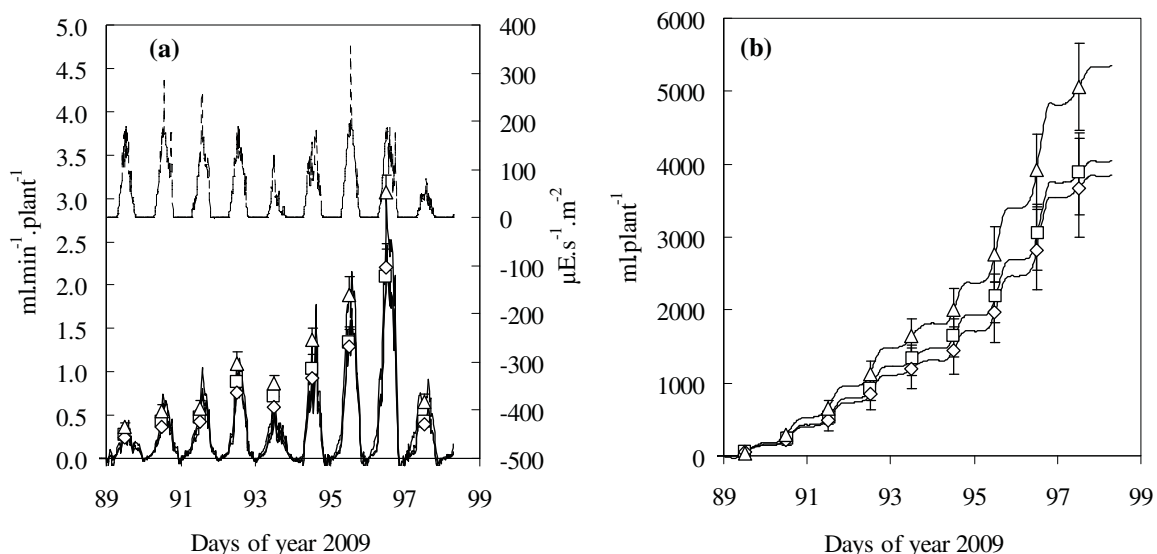

Fig. 3.7 : Sap flow during the experimentation period 2009 (a), and accumulate water transpirations (b) for *Control* (□), *N-Pulse* (◇), and *N-Supply* (Δ) treatments. Values are means \pm SD of 3 plants. Light intensity of greenhouse (---).

3.1.3.7 Plant Architecture

The total biomass of plants before bud break (*Start*) and 15 days after bud break (*Control*, *N-Pulse* and *N-Supply* treatments) were not significantly different. However, the biomass of the above-ground was lower than this of the below-ground at the *Start*, 40% and 60% of total dry weight, respectively. In contrast, after bud break, the biomass of the above-ground was higher than this of the below-ground: 51% and 49% for *Control*, 53% and 47% for *N-Pulse*, and 55% and 45% for *N-Supply*, respectively.

The biomass of plant tissue components showed that big root (BR), and fine root (FR) biomass decrease after bud break, especially for *N-Pulse* and *N-Supply* treatments. Contradictory, the biomass of stem xylem (SX) and new shoot (NS) increase after bud break. 15 days after bud break, N supplied to plants before bud break (*N-Pulse*) provided no effect on the biomass of all plant tissue components, when compared to *Control* treatment. However, the fine root biomass (FR) of trees from the *N-Supply* treatment was significantly lower than *Control* trees ($P < 0.01$) by 16% whereas *N-Pulse* biomass of fine roots was intermediate. The same tendency was found with the big root (Fig. 3.8).

Nitrogen supply before bud break (*N-Pulse* and *N-Supply*) has no significant effect on the dry weight of leaves, the number of new shoots, and the number of leaves. However, dry weight of leaves, the number of new shoots, and the number of leaves in *N-Pulse* and *N-Supply* treatments were slightly higher than *Control* treatment. Nitrogen supply before bud break has an effect on leaf area for both *N-Pulse* and *N-Supply* treatments which was increased higher than in *Control*, by 26% and 44%, respectively (Table 3.2).

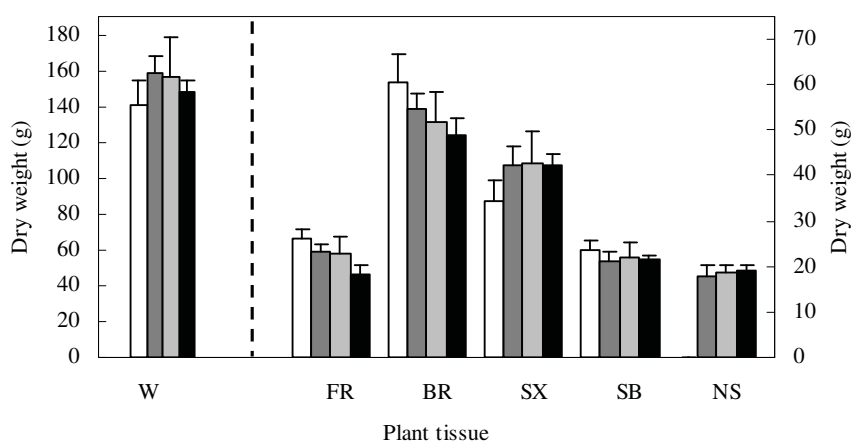

Fig. 3.8 : Plant tissue dry weight during the experimentation period 2009 at *Start* (□) and in *Control* (■), *N-Pulse* (▨), and *N-Supply* (■) treatments of whole plant (*W*), fine root (*FR*; diameter ≤ 2 mm), big root (*BR*; diameter > 2 mm), stem xylem (*SX*), stem bark (*SB*), and new shoot (*NS*). Values are means \pm SD of 3 plants at *Start* and 5 plants in *Control*, *N-Pulse*, and *N-Supply*.

Table 3.2 : Architecture of new shoots 15 days after bud break during the experiment period 2009.

	Dry weight of leaves (g)	Number of new shoots	Number of leave	Leave area (cm ²)
<i>Control</i>	13.93 \pm 1.94	44 \pm 3	352 \pm 42	4662.05 \pm 586.67
<i>N- Pulse</i>	14.86 \pm 1.12	44 \pm 3	371 \pm 17	5853.06 \pm 424.67
<i>N-supply</i>	15.48 \pm 1.16	46 \pm 4	378 \pm 29	6703.12 \pm 460.10
P-value	ns	ns	ns	**

Data are means \pm SD of five plants per treatment

^{ns} non significant

**significant (P < 0.01)

3.1.3.8 Nitrogen

Nitrogen content of whole plant (W) before (*Start*) and after bud break (*Control*, *N-Pulse*, and *N-Supply*) was significantly different ($P < 0.01$) (Fig. 3.9). Nitrogen content of the whole plant increased when N was supplied to trees either as an *N-Pulse* or *N-Supply* treatments. The N content of *N-Pulse* and *N-Supply* treatments was higher than in *Control*, by 0.20 and 0.70 fold, respectively.

In *Control*, N in stem xylem and stem bark decreased after bud break, as it was compared to N contents before bud break (*Start*). This decrease may be related to N allocation to new shoot. Nitrogen content in plant tissues for *N-Pulse* indicates that N content in fine root, stem xylem, and stem bark was slightly higher than *Control* but the differences were not significant. In contrast, the N content of new shoot was significantly ($P < 0.01$) higher for *N-Pulse* than for *Control* treatment, by 0.32 fold. The increment of N content in fine root ($P < 0.05$), big root ($P < 0.01$), stem bark ($P < 0.01$), and new shoot ($P < 0.01$) was higher for *N-Supply* than for *N-Pulse* treatment (0.16, 0.76, 0.41 and 0.37 fold) and *Control* treatment (0.45, 0.32, 0.86 and 0.81 fold). In contrast, the N contents in stem xylem after bud break of trees from the *Control*, *N-Pulse*, and *N-Supply* treatments were not significantly different (Fig. 3.9).

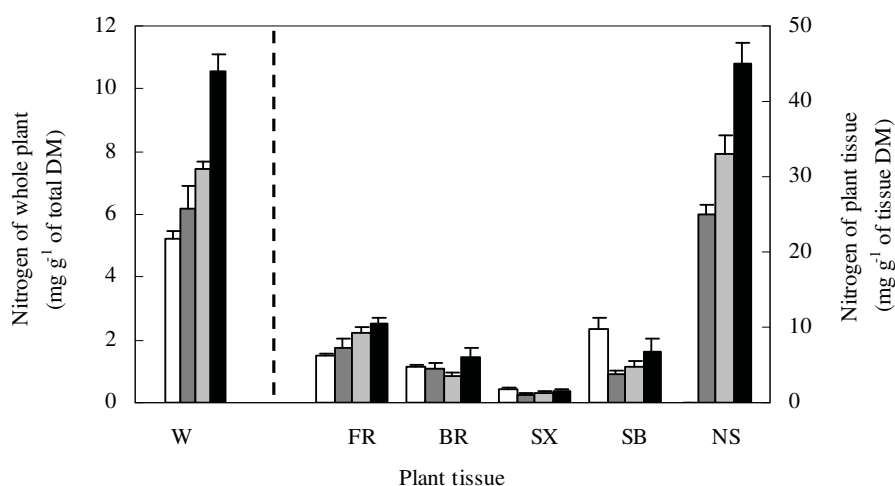

Fig. 3.9 : Nitrogen content of dry weight during the experimentation period 2009 at *Start* (□), and for *Control* (■), *N-Pulse* (▨), and *N-Supply* (■) treatments on the whole plant (W), fine root (FR; diameter ≤ 2 mm), big root (BR; diameter > 2 mm), stem xylem (SX), stem bark (SB), and new shoot (NS). Values are means \pm SD of 3 plants of *Start* and 5 plants of *Control*, *N-Pulse*, and *N-Supply*.

Nitrogen Mobilization

Nitrogen net flow (NNF) was calculated for all tissues by comparing their estimated N content at the start to that of measured at the end of the experiments. Nitrogen content estimation at the experiment start before the application of *Control*, *N-Pulse*, and *N-Supply* treatments in each compartment tissue showed that the N content in fine root, big root, and stem bark was significant ($P < 0.05$), but not in the xylem stem (Table 3.3). At the experiment start before the application treatments (before bud break), N content in all compartments was higher for *Control* than *N-Pulse*, and *N-Supply* treatments. This significant difference of N content between each treatment was found to be due to the different size of stems at the experiment start (Table 3.1)

Table 3.3 : Measured N content in the start sample (*Start*) and estimated N content in *Control*, *N-Pulse*, and *N-Supply* at the experiment start before the application of treatments, in fine root (FR), big root (BR), stem xylem (SX), bark (SB), and the sum of compartment tissues (SUM)

Tissues	Estimation nitrogen data before bud break			<i>Start</i>	P-value
	<i>Control</i>	<i>N-Pulse</i>	<i>N-Supply</i>		
<i>FR</i>	0.21 ± 0.03 a	0.19 ± 0.03 ab	0.16 ± 0.02 b	0.16 ± 0.01 b	*
<i>BR</i>	0.39 ± 0.05 a	0.34 ± 0.05 ab	0.30 ± 0.03 b	0.29 ± 0.02 b	*
<i>SX</i>	0.08 ± 0.01	0.07 ± 0.01	0.06 ± 0.00	0.06 ± 0.00	ns
<i>SB</i>	0.30 ± 0.05 a	0.27 ± 0.04 ab	0.23 ± 0.02 b	0.23 ± 0.01 b	*
<i>SUM</i>	0.98 ± 0.14 a	0.87 ± 0.13 ab	0.75 ± 0.07 b	0.74 ± 0.04 b	*

Data are means ± SD of 3 plants of *Start* and 5 plants of *Control*, *N-Pulse* and *N-Supply*.

^{ns} non significant

*significant (0.05)

Nitrogen mobilization for new spring growth depended on two conditions: the current N supply and the previously stores N remobilization. In our experimental design, trees from the *Control* treatment only rely on internal remobilization of N stored in plant tissues. Trees from the *N-Pulse* and *N-Supply* treatments rely on both sources.

Using equation 2 described in the material and method section, we were able to estimate the N net flows (NNF) in each compartment tissue, expressed as N percent of N stored during the previous year. As a general rule, a positive NNF indicates N was exported from compartment tissues to new shoot whereas a negative value indicates an N was loaded from other compartment and/or N uptake. The sum NNF in each compartment tissue was significantly different ($P < 0.01$) comparing all treatments. The results of NNF for the *Control*

conditions, 15 days after bud break showed that 45% of total stored N was exported for new shoot growth. In contrast, total NNF for *N-Pulse* and *N-Supply* treatments was decreased, N was exported to growth of new shoots represented 38% and 7% of the total stored N, respectively (Fig.3.10).

The NNF of all parts exhibited significant differences ($P < 0.01$) comparing all experiments. Results of NNF for *N-Pulse* and *N-Supply* treatments, in fine root, showed that fine root accumulated N, 9% and 20% of stored N in fine root, respectively; while the N for *Control* conditions was exported, 21% of stored N in fine root. In big root, N for *Control* and *N-Pulse* treatments was exported, 35% and 48% of stored N in big root, respectively. In contrast, NNF for *N-Supply* treatment decreased, N in big root was accumulated by 1% of stored N in big root. For stem xylem, N for *Control* and *N-Pulse* treatments was exported, 46% and 21% of stored N in stem xylem, respectively. Contrastingly, NNF for *N-Supply* treatment was decreased, N in stem xylem accumulated, 3% of stored N in stem xylem. Interestingly, NNF of stem bark was significantly different, considering all treatments. Nitrogen for *Control*, *N-Pulse*, and *N-Supply* conditions was exported, 75%, 61%, and 38% of the stored N in stem bark, respectively (Fig. 3.10).

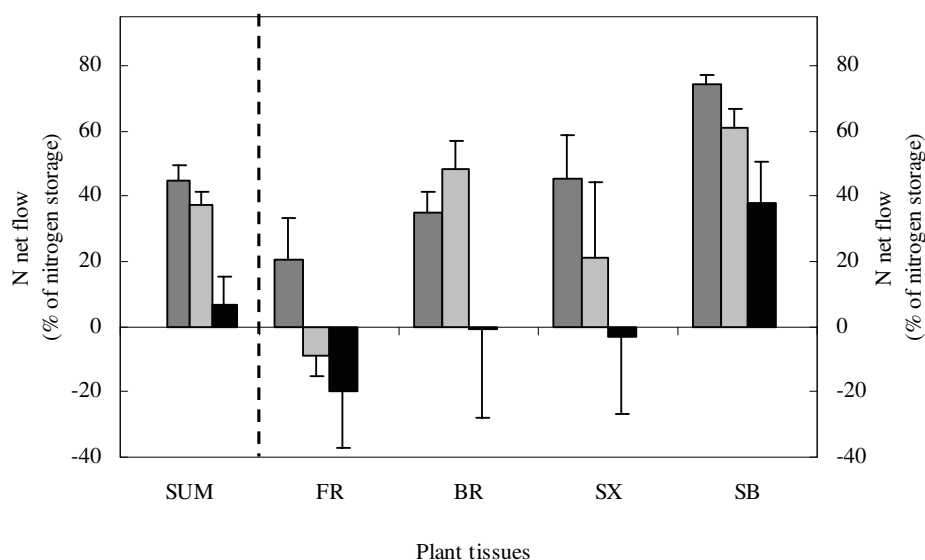

Fig. 3.10 : Nitrogen net flows (% of stored nitrogen in tissues) 15 days after bud break during the experimentation period of 2009 in *Control* (■), *N-Pulse* (□), and *N-Supply* (■) conditions, coming from the sum of component tissues (*SUM*), fine root (*FR*; diameter ≤ 2 mm), big root (*BR*; diameter > 2 mm), stem xylem (*SX*), and stem bark (*SB*).

Values are means \pm SD of 5 plants.

In the one-year scion poplars were grown in solution without N supply (*Control*) during bud break, and assumed that N which used to supported new shoots growth individually come from N remobilization of each compartment tissue. Therefore, for the sum of nitrogen net flow to total nitrogen found in new shoots (sink), it was found that the sum of nitrogen net flow for *Control* experiments was actually 100% of total nitrogen in new shoots. Splitting compartment tissues, the N mobilization to new shoots of *Control* conditions showed that nitrogen is mainly provided by stem bark (51.7%), big root (30.3%), fine root (9.7%) and stem xylem (8.3%), respectively. However, the sum of nitrogen net outflow in *N-Pulse* and *N-Supply* conditions was lesser than the total nitrogen of new shoots. The sum of NNF for both treatments was 53% and 6% of the total nitrogen content in new shoots, respectively (Table 3.4). It is therefore possible that nitrogen uptake, in these experiment conditions, is used to fill up nitrogen reserve of each tissue component, and/or for new shoot growth, thus disturbing and decreasing stored N remobilization. Nitrogen uptake was used directly to support new shoots.

Table 3.4 : Nitrogen net flow in each compartment tissue compared to the total N content in new shoots (% of total nitrogen content in new shoots) for *Control*, *N-Pulse*, and *N-Supply* treatments, in fine root (*FR*), big root (*BR*), stem xylem (*SX*), stem bark (*SB*), and sum of compartment tissues (*SUM*).

Tissues	<i>Control</i>	<i>N-Pulse</i>	<i>N-Supply</i>
<i>FR</i>	9.6 ± 4.8	-2.7 ± 2.0	-3.6 ± 3.1
<i>BR</i>	30.3 ± 3.6	26.3 ± 3.9	-0.4 ± 9.4
<i>SX</i>	8.3 ± 2.63	2.4 ± 2.6	-0.3 ± 1.7
<i>SB</i>	51.7 ± 5.9	26.7 ± 2.6	10.2 ± 3.5
<i>SUM</i>	100 ± 0.0	52.6 ± 3.42	5.9 ± 7.9

Data are means ± SD of 3 plants

3.1.3.9 Non Structural Carbon

Monosaccharide

Monosaccharide content (glucose and fructose) of whole plant, without leaf, increases after bud break, particularly in *N-Pulse*, *Control*, and *N-Supply* treatments. The monosaccharide content of such treatments was higher than at *Start* (before bud break) by 1.01, 0.67 and 0.08 fold, respectively. Likewise, monosaccharide content of the other plant tissue components after bud break for *Control* treatment increases in stem xylem, stem bark, and big root ($P < 0.01$). In contrast, the monosaccharide content in fine root in *Control* treatment was significantly lower than at *Start*. Further analysis on monosaccharide content after bud break of plants supplied

with nitrogen before bud break (*N-Pulse*) indicated that the monosaccharide content in stem bark increases and higher than that of *Control* and *N-Supply* treatments. Monosaccharide content in fine root, big root, and stem xylem in *N-Pulse* and *Control* conditions were not significantly different. From this result, monosaccharide content in stem xylem for *N-Supply* treatment decreases significantly lower than in *Control* and *N-Pulse* conditions ($P < 0.01$). However, the monosaccharide content in fine root and big root for *N-Supply* conditions, non significant difference was revealed (Fig. 3.11a).

Sucrose

Sucrose content of whole plant, without leaf, decreases after bud break. The sucrose content for *N-Supply*, *N-Pulse*, and *Control* treatments was lower than at *Start* by 0.53, 0.43, and 0.35 fold, respectively. The sucrose content in other plant tissue components decreases after bud break, predominantly in fine root. Comparing sucrose content after bud break for *Control*, *N-Pulse* and *N-Supply* treatments revealed that sucrose content in fine root and big root was not significantly different. However, sucrose content in stem bark in *N-Supply* conditions decreases significantly ($P < 0.01$) lower than that of *Control* and *N-Pulse* treatments; 0.46, 0.29 fold, respectively. The sucrose content for *N-Supply* treatment in stem xylem decreases significantly ($P < 0.01$) lower than that for *Control* one (Fig. 3.11b), while sucrose in stem xylem and stem bark *N-Pulse* and *Control* conditions is not significantly different.

Starch

Starch content in *N-Pulse*, *Control*, and *N-Supply* conditions, in the whole plant without leaf, decreases significantly ($P < 0.01$). Such starch content was lower than that at *Start*, by 0.73, 0.72, and 0.63 fold, respectively. The results also indicated that, concerning other plant tissue components, big root and fine root tissues were the most important locations for starch storage. Starch content on such plant tissues, after bud break (*Control*, *N-Pulse*, and *N-Supply*), was significantly ($P < 0.01$) lower than at *Start*.

Comparing starch content after bud break in fine root, stem xylem, and stem bark of nitrogen supplied plants before bud break (*N-Pulse* and *N-Supply*) to *Control* conditions reveals that starch content for *N-Pulse* and *N-Supply* treatments is lower than in *Control* conditions. Despite starch content in fine root for *N-Pulse* conditions was not significantly different to *Control*, and *N-supply* conditions, the *N-Supply*'s starch was significantly ($P < 0.01$) lower than that of *Control*, by 0.40 fold. Results of starch content in stem xylem for *N-Pulse* conditions was significantly ($P < 0.01$) lower than *Control* ones, while it was higher than that in *N-Supply*

ones. As a result of such significant differences, starch content of stem bark for *N-Pulse* and *N-Supply* treatments was significantly ($P < 0.01$) lower than in *Control*, by 0.59 and 0.83 fold, respectively (Fig. 3.11c). In contrast to starch content in big root for *N-Pulse* and *N-Supply* treatments, it was higher than *Control*. The starch content in big root for *N-Supply* conditions is higher than that in *N-Pulse* and *Control* ones, by 0.57 and 0.90 fold, respectively.

Non-structure Carbon Used of Compartment Tissues

Generally, carbon accumulates in plant tissue compartments (sinks) via the photosynthesis. This stored carbon is used to support plant growth during low photosynthesis period, respiration during winter rest, and to sustain new shoots production in spring. Estimation of the NSC net flow from tissue compartments was calculated by comparing NSC content in all tissue compartments at the experiment start before the application of treatments (estimation) and at the end of experimentations.

Estimating NSC in each compartment tissue at the experiment start before the application of *Control*, *N-Pulse* and *N-Supply* conditions showed that NSC in big root was significant ($P < 0.05$). Non structural carbon in big root for *Control* treatment was higher than for *N-Supply* one, while NSC in fine root, stem xylem, and stem bark was not significantly different (Table 3.5). However the sum of NSC of each compartment tissue, before bud break, in *Control* conditions was higher than in *N-Pulse* and *N-Supply* ones. The difference of NSC content in tissues was found to be relates to the different size of stems at the experiment start (Table 3.1)

Table 3.5 : Measured non structural carbon content at the start sample (*Start*) and estimated non structural carbon in *Control*, *N-Pulse*, and *N-Supply* conditions at the experiment start before the application of treatments, in fine root (FR), big root (BR), stem xylem (SX), stem bark (SB), and the sum of component tissues (SUM).

	Estimate non-structure carbon			<i>Start</i>	P-value
	<i>Control</i>	<i>N-Pulse</i>	<i>N-Supply</i>		
<i>FR</i>	4.36 ± 0.44	4.37 ± 0.73	3.60 ± 0.36	4.49 ± 0.93	ns
<i>BR</i>	30.29 ± 2.48 a	27.84 ± 2.07 ab	24.83 ± 1.57 b	23.99 ± 5.73 b	*
<i>SX</i>	1.22 ± 0.13	1.24 ± 0.21	1.24 ± 0.08	0.99 ± 0.33	ns
<i>SB</i>	1.07 ± 0.10	1.12 ± 0.18	1.12 ± 0.06	1.19 ± 0.06	ns
<i>SUM</i>	36.94 ± 2.66 a	34.57 ± 3.08 ab	30.78 ± 1.92 b	30.65 ± 5.10 b	*

Data are means ± SD of 3 plants of *Start* and 5 plants of *Control*, *N-Pulse*, and *N-Supply*

^{ns} non significant

*significant (0.05)

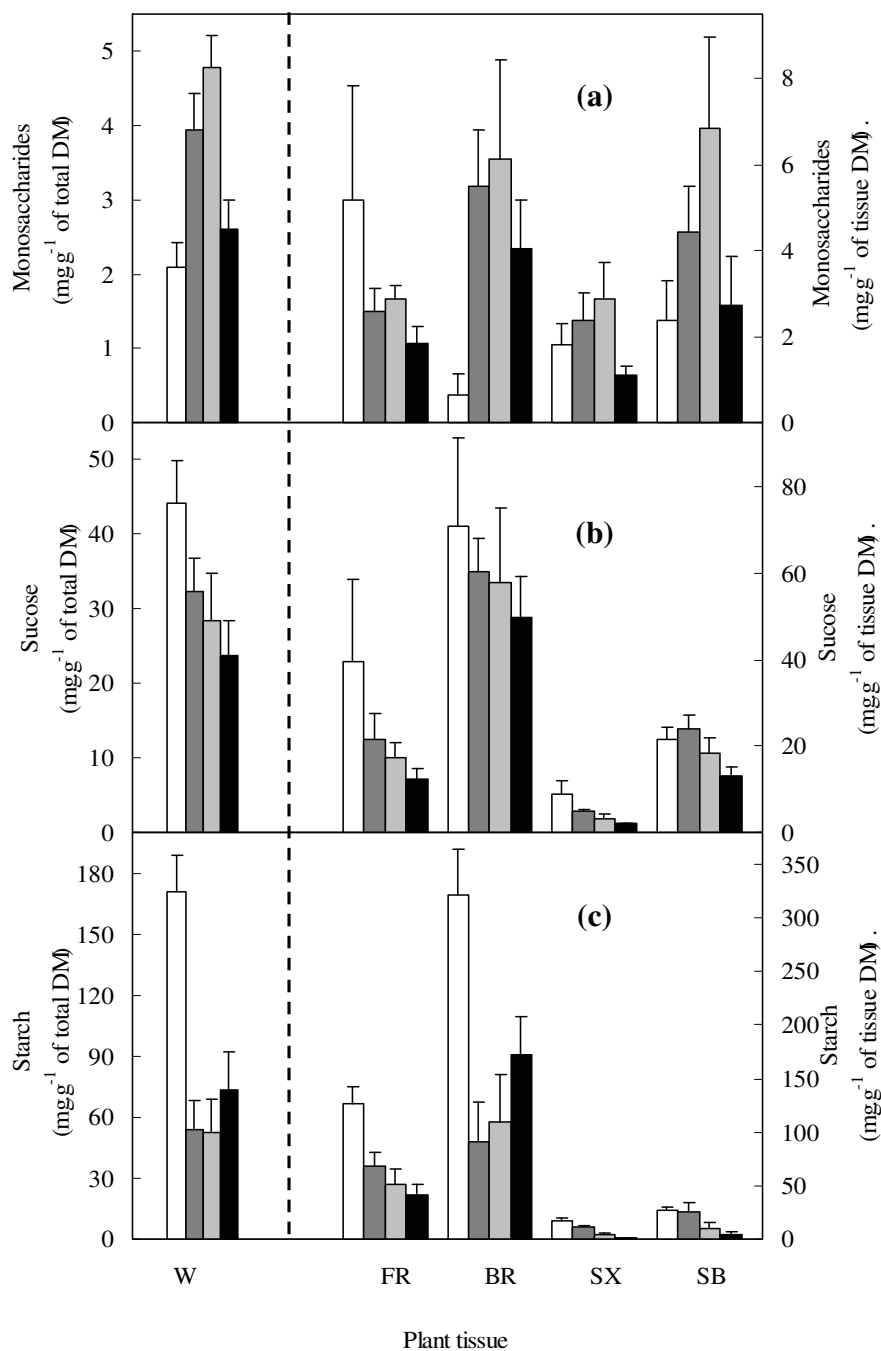

Fig. 3.11 : Non structural carbon of dry weight ($\text{g}\cdot\text{g}^{-1}$) during the experimentation period 2009, Monosaccharide (glucose and fructose) content (a), sucrose content (b) and starch content (c) of dry weight at *Start* (\square), and in *Control* (\blacksquare), *N-Pulse* (\square), and *N-supply* (\blacksquare) conditions. Measurements were made on the whole plant without leaf (*W*), fine root (*FR*; diameter ≤ 2 mm), big root (*BR*; diameter > 2 mm), stem xylem (*SX*), and stem bark (*SB*). Values are means \pm SD of 3 plants of *Start* and 5 plants of *Control*, *N-Pulse*, and *N-Supply*.

Using Equation 4 described in the material and method section, this study was able to estimate the NSC net flow in each compartment tissue, expressed as NSC percent of NSC stored during the previous year. As a general rule, a positive NSC net flow indicates NSC was exported from compartment tissues used for respiration and new growth whereas a negative value indicates an NSC was loaded from other compartment tissues.

The sum NSC net flow in each compartment tissue was not significantly different in all cases. However the trend of sum NSC under *N-Pulse*, and *N-Supply* conditions showed a lower decrease than under *Control* one, 58%, 65%, and 66%, respectively. In addition, the NSC net flow in each component tissue was altered when nitrogen was up taken during bud break. In *N-Pulse* and *N-Supply* conditions the NSC net flow from fine root ($P<0.05$), stem xylem ($P<0.01$), and stem bark ($P<0.01$) was significantly higher than in *Control* one. *N-Pulse* conditions used stored NSC from fine root and stem xylem more than *Control* conditions, by 0.22 and 0.81 fold, respectively. *N-Supply* treatment used stored NSC from fine root and stem xylem more than *Control* treatment, by 0.41 and 1.33 fold, respectively. It was also pointed that the *N-Pulse* and *N-Supply* treatments used of NSC from stem bark was 30% and 62% of the total stored NSC in stem bark, respectively. However, *Control* conditions increased NSC accumulations in stem bark by 8% of the stored NSC in stem bark. The NSC used from big root of *N-Pulse* and *N-Supply* conditions was lower slightly than under *Control*, but the difference was not significant (Fig.3.12).

In addition, this experiment compared the total NSC used during the experiment period, and carbon used for produce new shoots re-growth. However, this experiment did not measured carbon used for produced new shoots re-growth, assuming that new shoots dry weight is equal to their total carbon used for new shoot re-growth. Comparing the total NSC used during the experiment period and dry weight of new shoots revealed that the total NSC used under *Control* and *N-Pulse* conditions was higher than the carbon weight of new shoots, 6.69 g and 3.75 g, respectively. In contrast, the total NSC used in *N-Supply* treatment was lower than the dry weight of new shoots (1.17 g) (Table 3.6). Therefore, the differentiation of NSC used during the experiment period and dry weight of new shoots showed that supplying nitrogen treatments (*N-Pulse* and *N-Supply*), increased carbon assimilation.

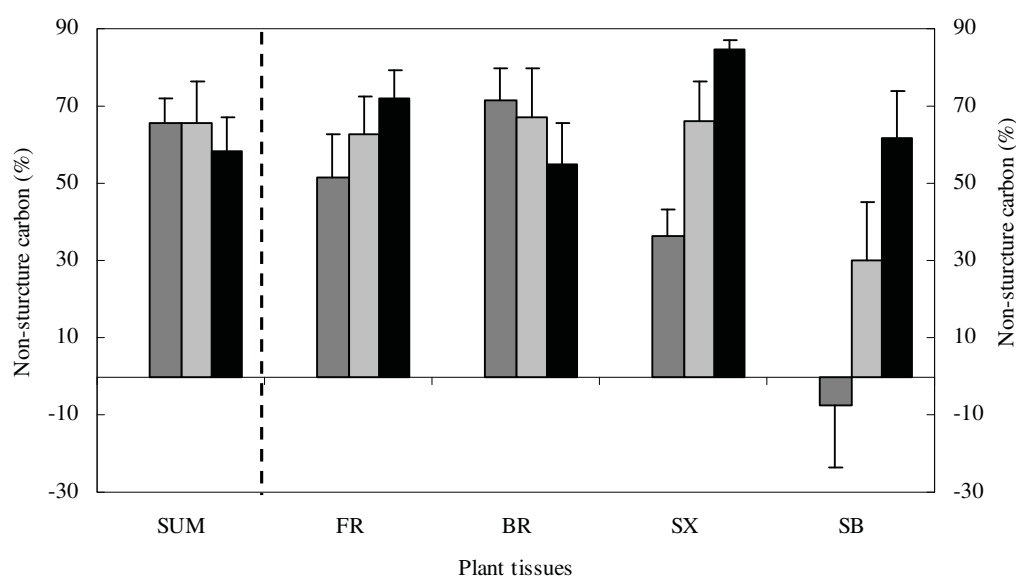

Fig. 3.12 : Non structural carbon used during the experimentation period 2009 (% of NSC storage of tissue), under *Control* (■), *N-Pulse* (□), and *N-Supply* (■) conditions, from fine root (*FR*; diameter ≤ 2 mm), big root (*BR*; diameter > 2 mm), stem xylem (*SX*), stem bark (*SB*), and the sum of component tissues (*SUM*). Values are means \pm SD of 5 plants

Table 3.6 : The total non structural carbon used during the experiment period versus dry weight of new shoot, 15 days after bud break.

	Total Non structure carbon used (g)	Dry weight of new shoot (g)	Difference ¹ (g)
<i>Control</i>	24.35 \pm 3.65 a	17.66 \pm 2.49	6.69 \pm 2.12 a
<i>N- Pulse</i>	22.47 \pm 3.00 a	18.72 \pm 1.55	3.75 \pm 4.47 a
<i>N-Supply</i>	17.99 \pm 3.06 b	19.17 \pm 1.18	-1.17 \pm 2.74 b
P-value	**	ns	**

Data are means \pm SD of five trees per treatment

**significant (0.01)

¹ Data difference between non structural carbon use (g) and dry weight of new shoot (g)

3.1.3.10 Mineral Uptake

Four uptake minerals were compared between *Control*, *N-Pulse*, and *N-Supply* conditions: potassium, phosphorus, calcium and magnesium.

Potassium

Dynamic curves of potassium uptake showed that potassium was up taken only *Control* conditions before and after bud break until, the end of experiment. Potassium was up taken by *N-Pulse* and *N-Supply* conditions for 2 days when the temperature in greenhouse was increased. Then, such potassium, in both treatments, was flowed out until bud break. The potassium was up taken again after bud break, as in such a period leaf area was developed. For *N-Supply* experiments, plant was uptake nitrogen faster than in *N-Pulse* one. The total potassium uptake of *Control*, *N-Pulse*, and *N-Supply* treatments was 0.28, 0.23, and 0.38 g.plant⁻¹, respectively (Fig. 3.13a).

Phosphorus

Dynamic curves of phosphorus uptake show that *Control*, *N-Pulse*, and *N-Supply* treatments could uptake phosphorus before and after bud break until the end of experiment (Fig. 3.13b). In the first week after start experiment, the same quantity of phosphorus was up taken in all treatments. After that, and until the end of experiment, the phosphorus was taken up in *Control* conditions higher than *N-Pulse* and *N-Supply* ones. Bud break had an effect on the phosphorus uptake of plants. Ten days after bud break, the phosphorus was rapidly up taken by *Control*, *N-Pulse*, and *N-Supply*. The total phosphorus uptake at the end of experiment in those conditions was 0.058, 0.058, and 0.045 g.plant⁻¹, respectively.

Calcium and Magnesium

Calcium and magnesium was up taken both before and after bud break until the end of experiment in all treatments. However, when N was supplied before bud break (*N-Pulse* and *N-Supply*) the calcium and magnesium uptake of such treatments was higher than that of *Control* one. Likewise, both calcium and magnesium were taken up dramatically after bud break in *N-Supply* treatment, while the calcium and magnesium uptake of *Control* and *N-Pulse* were stable until the end of experiment (Fig. 3.13c and 3.13d). At the end of experiments, *Control*, *N-Pulse*, and *N-Supply* uptake calcium was 0.1, 0.13, and 0.22 g.plant⁻¹, respectively and that of magnesium was 0.03, 0.04, and 0.07 g.plant⁻¹, respectively. In *Control*, *N-Pulse*,

and *N-Supply* conditions, calcium uptake was higher than magnesium one by 3.3, 3.1, and 3.1 fold, respectively.

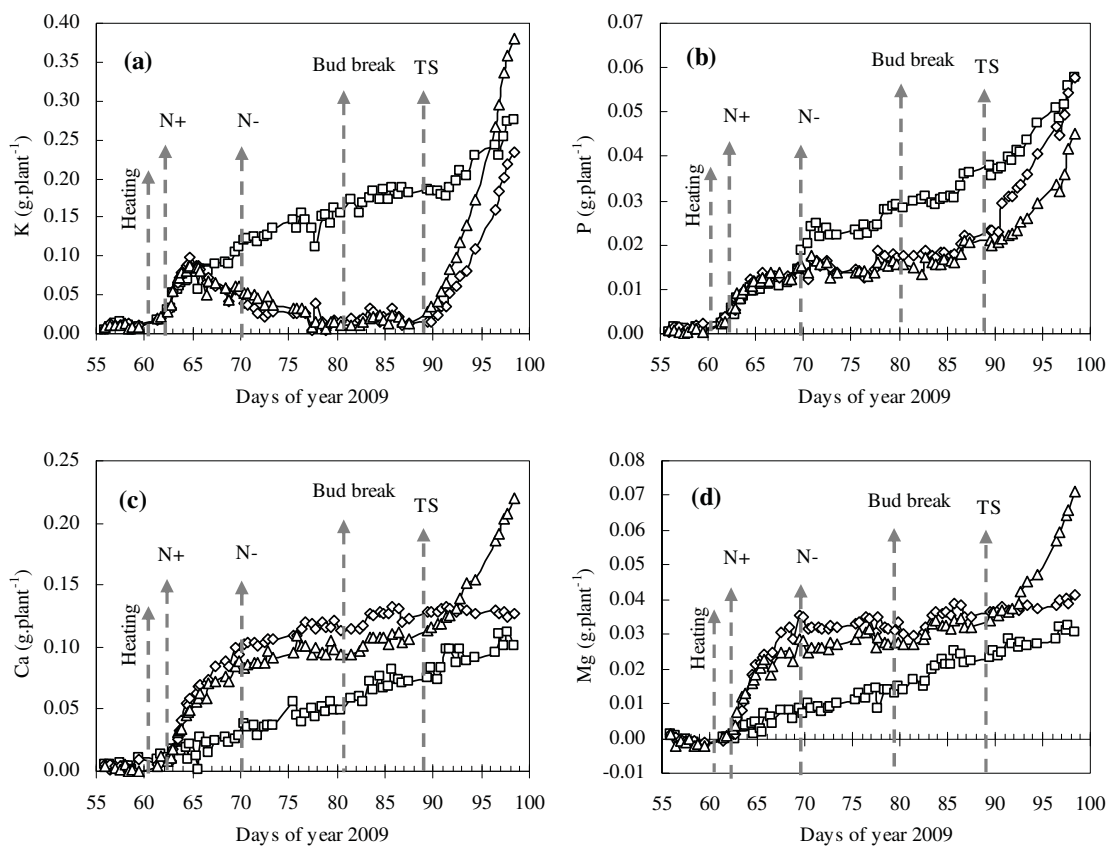

Fig. 3.13 : Cumulated potassium (a), phosphorus (b), calcium (c), and magnesium (d), (g.plant⁻¹) taken up by the one-year scion poplar during the experiment period 2009 in *Control* (□), *N-Pulse* (◇), and *N-Supply* (Δ) conditions. The arrows represent the time of increase temperature in greenhouse, start experiment during nitrate solution supply in *N-Pulse* and *N-supply* treatments (N+), first time change solution without nitrate to *N-Pulse* treatment (-N), bud break period (Bud break), and start transpiration (TS), respectively

3.1.4 Discussion

3.1.4.1 Nitrogen Uptake

This study found that poplar can uptake N before bud break. Total N uptake for *N-Pulse* and *N-Supply* was about 0.34 and 1.08 fold of the total N storage of the previous year. Such result is consistent with the results that are suggested by previous studies which were focuses on young maples (Delaire *et al.*, 2005) and one-year-apples (Dong *et al.*, 2001). However, the accumulation of N uptake in roots cannot be transported by xylem to other tissues until transpiration begins (Dong *et al.*, 2001; Frak *et al.*, 2002; Guérin *et al.*, 2007; Millard *et al.*, 2006; Salaün *et al.*, 2005). Then, the N compound accumulation in roots, before bud break, was regulated decreasing nitrate uptake. However, the regulating process of N up taken by tree roots was not fully clarified at this experiment stage, according to external and internal conditions. By this regard, several studies found that external conditions could link available N, pH and temperature in root zone (Dong *et al.*, 2001; Ter Steege *et al.*, 1999; van den Driessche *et al.*, 2008; Yin *et al.*, 2009), and some internal factors able to reduce N uptake of plants such as the accumulation of N compound in roots. Recent studies of Gessler *et al.* (2004) and Dluzniewska *et al.* (2006) supported that inhibitory effect of amino acids in root tissues on N uptake. This activity is suggested to be a signal of the internal N status of plants. Furthermore, glutamine feeding also increased concentrations of various amino acids (Gln, Glu, Ala, and GABA) and NH_4^+ in poplar roots (*Populus tremula* × *P. canescens*), which all negatively correlated with NO_3^- uptake (Dluzniewska *et al.*, 2006). Therefore, N compound accumulation in root feedback regulation can reduce up-taken nitrate during bud break (Dluzniewska *et al.*, 2006; Gessler *et al.*, 2004; Miller *et al.*, 2008). This hypothesis was confirmed by the after bud break results of this experiment, which found the role of root feedback regulation of plants. This study found that when leaf area growth was recovered and transpiration increased, then N accumulated in root transport to shoots, the one-year scion-poplar also up-took nitrate dramatically again.

3.1.4.2 Root Pressures

Positive xylem sap pressures near the root of poplar before bud break were observed, therefore, this study assumed that such xylem pressures come from roots activity. This study found that poplars exhibited positive xylem pressure when nitrate was supplied before bud break. Such result is consistent with the studies of Delaire (2005) in maple (*Acer pseudoplatanus*) and Ewer *et al.* (2001) in walnut during autumn and spring (*Juglans regia* L.).

Their results found that walnuts can uptake nitrate when soil temperature was high and such nitrogen uptake induced root pressure.

3.1.4.3 Sap Flow

In this experiment sap flow could not be measured during the first 6 days after bud break with the heat balance method. This result is consistent with the study of Frak *et al.* (2002) which propose that such situation happen because the leaf area of walnut was lower than 0.1 m². The effect of nitrate can be explained by the increase of water flow. The water flow of plants is able to be increased in two conditions. First, the water flow increases when the mass flow of water toward roots by increasing leaf area enhancing transpiration rates (Table 1). Supporting such statement was found in the Domenicano *et al.* (2011)'s study, where a positive association between transpiration and leaf area of plants, especially when plants were grown in the solutions with nitrate, was set up. The second condition of increasing water flow in plants is the accumulation of nitrate by root adjustments, which will increase root hydraulic properties (Gloser *et al.*, 2007; Gorska *et al.*, 2008a; Gorska *et al.*, 2008b).

3.1.4.4 Plant Development

Temperate plant change of the biomass proportion of above-ground and below-ground depends on seasons (Pregitzer *et al.*, 1990). After bud break, poplar remobilizes storage biochemical such as carbon and nitrogen to new growth, thus the biomass of below-ground decreases. However, the biomass increase of above-ground was related to new shoot (Dyckmans and Flessa, 2001; Landh usser and Lieffers, 2002; Landh usser and Lieffers, 2003; Sala un *et al.*, 2005).

Although supplied N before bud break induced N uptake and root pressure before bud break, it conveyed no effect on the date of bud break (Fig. 3.4), the number of bud break, and the number of leaves (Table 3.2). It is possible that N uptake before bud break accumulated in roots and was not exported to buds until bud break and the transpiration increase (Dong *et al.*, 2001). Generally, high temperature induces spring bud break in temperate plants when they break out dormancy. According to such condition, this experiment observed spring bud breaks by controlling the temperature in the greenhouse, at 18-20°C. Before starting the experiment, plants have successive auxiliary bud formation that form bud scales stipule and small leaf lamina (Fig. 3.14). The findings revealed that high temperature has an impact on plant bud break rather than other signals such as N uptake, and refilling of water by root pressure.

However, 15 days after bud break, leaf area increased in poplars that uptake nitrate before bud break. The total leaves area was closely correlated with total N in new shoot across all treatments (Fig. 3.15) Such result confirmed the studies of Change and Fuchigami (2002) and Dong *et al.* (2004) who have studied N supply during spring on apple and poplar cutting. In addition, the modulation of leaf area represents alternation of existing growth patterns by changing the rate of cell division and/or cell expansion and those mechanisms are adjusted by N availability (Cooke *et al.*, 2005).

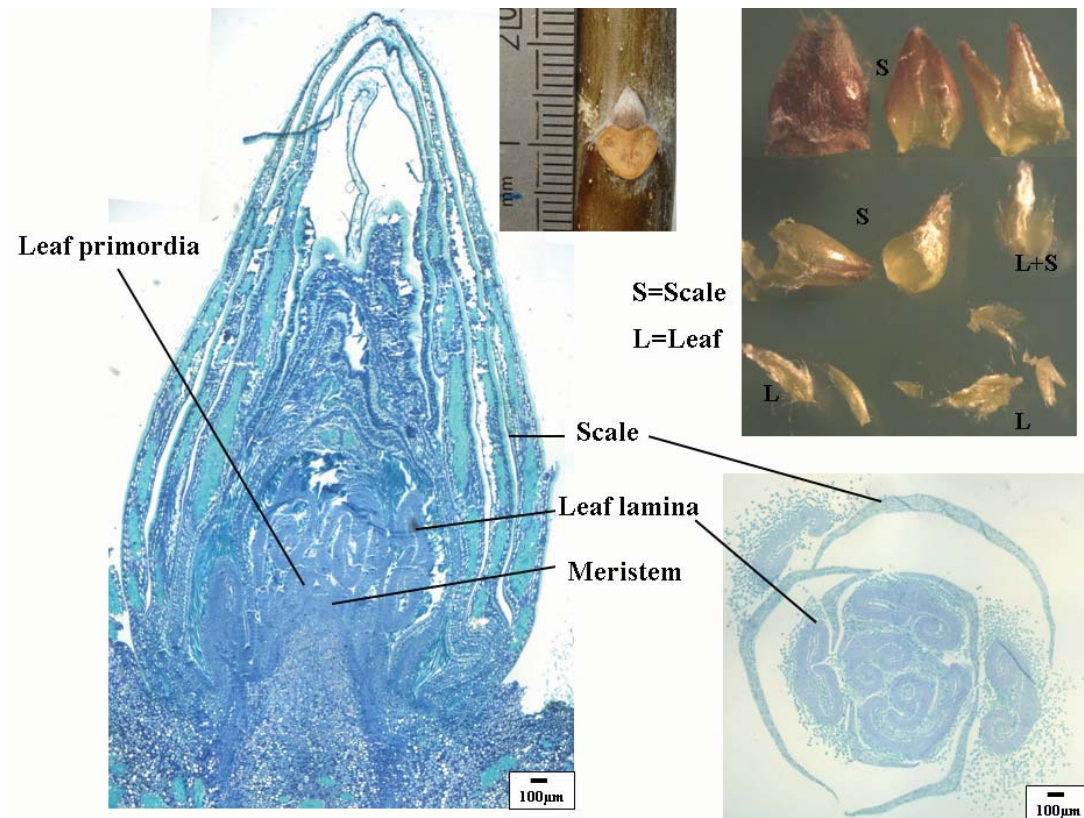

Fig. 3.14 : Morphology of axillary bud of poplars (*Populus tremula* × *Populus alba*, clone INRA 717-1B4) at the start of experiment period. Bud contents scale, small leaf, and meristem.

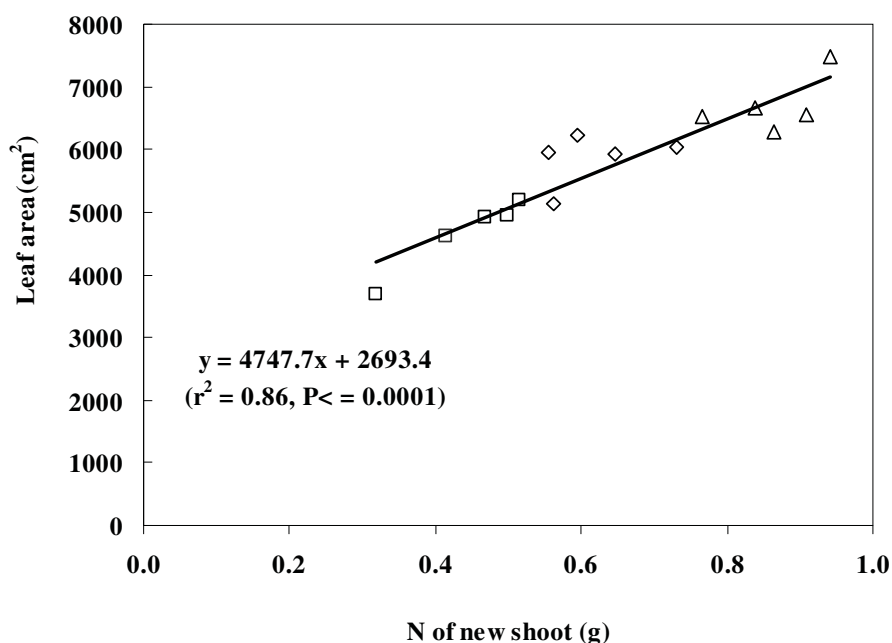

Fig. 3.15 : Total leaf area in relation to total nitrogen in new shoots of *Control* (□), *N-Pulse* (◇), and *N-Supply* (Δ) treatments.

3.1.4.5 Nitrogen Content

Generally, stored N in tissues can be remobilized for plant re-growth. New shoot growth is the strongest sink for N remobilization during spring growth. The experimental results support previous studies where deciduous trees increase stem and root N concentration in autumn, while such concentrations decrease in spring due to the increase of N content in new shoot (Dyckmans and Flessa, 2001; Frak *et al.*, 2002; Marmann *et al.*, 1997). In the one-year scion poplar, grown in solution without N supply during bud break, N storage in stem bark and big root is meaning tissues, mobilize to support new shoot by 51.8 and 30.3 percent of total N content in new shoot, respectively (Table 3.4).

Uptake nitrate before bud break on the one-year scion poplars, increases N content in other tissues, especially in new shoot 15 days after bud break, when compared to plant growing in solution without nitrate supply. However, such unobvious results indicates that whether the increase of N content in new shoot 15 days after bud break comes from N uptake or/and storage remobilization to new shoot. This is because, according to this experiment, N uptake and N remobilization in new shoots could not be separated. For example, experiments using ^{15}N to quantify spring uptake of N by root showed that the stored N mobilization for new shoots

growth in spring occurred before the utilization of uptaken N. Such utilization was found in some deciduous species such as *Malus domestica* (Guak *et al.*, 2003; Malaguti *et al.*, 2001), *Prunus avium* (Grassi *et al.*, 2003; Millard *et al.*, 2006) and *Pyrus communis* (Tagliavini *et al.*, 1997). In contrast, studies on other species have shown that N uptake in their roots begins concomitantly with N remobilization. These include deciduous *Jugulans nigra* × *J. regia* (Frak *et al.*, 2002), *Betula pendula* (Malaguti *et al.*, 2001) and evergreen *Pinus sylvestris* (Malaguti *et al.*, 2001).

In poplar, Millard *et al.* (2006) examined ten-year old poplars (*Populus trichocarpa* Torr. & Gray ex Hook var. *Hastata* (Dode) A. Henry × *Populus balsamifera* L. var. *Michauxii* (Dode)) in the field and supplied them with ^{15}N at bud break but found that the ^{15}N was not recovered in leaves until 36 days after bud break. In contrast to Millard's study, this study found that the sap mobilisation was functional within 15 days after bud break. The accumulated sap mobilisation by 15 days after bud break increased by 23- to 33-fold of the capacity that existed prior to bud break (Fig. 3.7 and Table 3.1). Based on this level of the increased sap mobilisation, it is reasonable to believe that sap mobilisation is sufficient to influence N uptake before bud break, which is then mobilised from the roots to other parts of the plant, including new shoots. The opposite finding with Miller's may be due to several reasons, such as plant materials and plant characteristics. This study used one-year-old whip poplars which were grown in perlite culture in pots and under a controlled environment. Based on these conditions, plants were cultivated by unlimited water and nutrients which may affect on the plant capability to uptake N. The opposite finding of N uptake of ten-year-old poplars by Miller's may be because of one-year-old scion poplar trees characteristics. The trunk of one-year-old scion trees is small. Therefore, nitrogen uptake in root after bud break has shorter distance to travel to the new shoots, the young poplars have a smaller and shorter trunk than bigger trees.

In addition, this experiment is different from previous studies by focusing on poplar uptake N before bud break. This study assumes that the new uptake N which is accumulated in root is functioning in the same way as the stored N from previous year. Both accumulated and stored N in root are exported to xylem and then transported to other tissues. This hypothesis was confirmed by the results of N net flow which found that total N net out flow of *N-Pulse* and *N-Supply* treatments do not recovered total N in new shoots 15 days after bud. The N net outflow in *N-Pulse* and *N-Supply* conditions was 53% and 6% of the N in new shoots, respectively (Table 3.4). Furthermore, N in all tissues increases and it is higher than that of *Control*. These processes were similar to the study of Dong *et al.* (2001) which showed that new shoot of the one-year-old apple can accumulate N from root uptake within the first 21 days

after bud break when apple up took N before bud break. In summary to this experimental stage, the results suggested that plants uptake N before bud break increases N reserve in their tissue compartments early in the re-growth period.

3.1.4.6 Non Structural Carbon Content

Deciduous tree uses stored carbon until adequate leaf developed for photosynthetic capacity to support net carbon assimilation. Xylem sap has been proposed as the principal route for transporting soluble carbohydrate, from exporting tissue stored carbon to sink such as bud and new shoot during re-growth (Bonhomme *et al.*, 2009; Decourteix *et al.*, 2008). In the one-year scion poplar (*Populus tremula* × *Populus alba*, clone INRA 717-1B4), starch was the main storage of carbon to support growth and metabolism in early spring. Starch and sucrose content decreased 15 days after bud break, concurrently monosaccharide increases (Fig. 3.10). Root exhibited major tissue stored non structural carbon (NSC). Big root and fine root store NSC 78% and 15% of total NSC. These results are consistent with studies performed in some deciduous tree such as *Pinus taeda*, *Populus tremuloides* (Landhäusser and Lieffers, 2002; Landhäusser and Lieffers, 2003; Ludovici *et al.*, 2002).

The NSC of tissues before bud break is remobilized to support respiration and new shoot growth after bud break (Barbaroux *et al.*, 2003; Landhäusser and Lieffers, 2003; Wong *et al.*, 2003). In this experiment, the one-year scion poplar used NSC about 58% – 66% of total stored NSC. In addition, nitrogen uptake during experiments (*N-Pulse* and *N-Supply*) changed NSC used for each compartment tissue. *N-Pulse* and *N-Supply* conditions used NSC in fine root, stem xylem and stem bark higher than *Control* one. It is possible that the increase NSC use in *N-Pulse* and *N-Supply* conditions in their roots was the result of NSC use for active transport required for nitrate uptake and assimilation nitrate to ammonium or organic acid (Bloom *et al.*, 1992). Stem xylem and stem bark of *N-Pulse* and *N-Supply* increasingly used NSC to support new shoots development. As it can be seen from Table 3.2, in *N-Pulse* and *N-Supply* conditions, the trend of dry weight of leaves, the number of new shoots, the number of leaves, and leaf areas in particular, was higher than *Control* (Table 3.2).

In addition, carbon for supporting new shoot growth came from two sources: NSC remobilization and carbon assimilation. The NSC remobilization during bud break was performed until photosynthetic carbon assimilation was higher than respiration. During re-growth started period, the total NSC was used for respiration and supports new growth. However, when photosynthetic carbon assimilation was higher than respiration carbon consumption, part of such carbon synthesis increases the NSC content, while the rest was used

for new shoots growth. Therefore, total NSC used for new shoots re-growth was associated to carbon assimilation.

Generally, during the re-growth start period, the total NSC used is higher than carbon support for new shoots. Then, the calculated total NSC used and the carbon to support new shoot growth are compared as the association of photosynthesis. In this study, carbon used to produce new shoots was not measured. However, carbon used to produce new shoots was assumed as the dry weight of new shoots. Comparisons between the total NSC used and the dry weight of new shoots found that, the total NSC used was not recovered as the dry weight of new shoot when plants up took N before bud break (Table 3.6). Such results of this study confirm the hypothesis that plants uptake N before bud break increase carbon assimilation through the raise of photosynthesis activity. The results are consistent with previous studies which have demonstrated that increasing the level of supplied N availability to poplar, including leaf N concentration, is positively correlated to chlorophyll concentration, leaf area, and photosynthetic parameters as light-saturated photosynthesis (A_{max}), maximum carboxylation (V_{cmax}) and electron transport rate (J_{max}) (Cooke *et al.*, 2005; Ripullone *et al.*, 2003).

3.1.4.7 Mineral Uptake

The one-year scion poplar can uptake phosphorus, calcium, magnesium, and potassium before bud break without the necessity of N uptake. However, when N was taken up before bud break, it induces an increase of calcium and magnesium uptake. In addition, both calcium and magnesium were dramatically up-taken after bud break, and that was positively correlated to nitrate uptake. Therefore, calcium and magnesium uptake is likely to play a role on N uptake. Potassium uptake before bud break was not related to N uptake before bud break. However when uptake N on plants before and after bud break, then potassium uptake after bud breaks of plant was increased. Phosphorus uptake before and after bud break was not related to N uptake. The phosphorus was up taken dramatically after bud break, because in such period leaf area was developed and the transpiration increased. Therefore minerals uptake before and after bud break is likely depended on the effect of these factors, individually or together, that are N uptake, environment around roots, and transpiration of plant after bud break.

In summary, the results support the hypothesis that in poplar (*Populus tremula* × *Populus alba*, clone INRA 717-1B4), the one-year scion-poplar can uptake N before bud break. These results also showed N uptake before bud break had a significant effect to induced positive root pressure, the changes of N net flow in compartment tissues and increased N

reserve in compartment tissues link to the increased NSC used which has been stored from previous year in each compartment tissue, and increased leaf area. In addition, N uptake seems to be associated with calcium and magnesium uptake.

3.2 Experiment II:

Nitrogen Supply before Bud Break Influence on Early Spring Development of Stump-Poplars

3.2.1 Introduction

Poplar contributes to economy by producing large intensive biomass per unit of land area and having short-rotation coppice (Aylott *et al.*, 2008; Karp and Shield, 2008). When poplars are harvested or disturbed by above-ground part by decapitation, browsing by animal or insects feeding, such processes remove the above-ground portion of trees which lead to the imbalance of large source-sink of nutrients, especially for carbon and N reserves in roots. However, such nutrients are important for the re-growth capacity of plants (Bollmark *et al.*, 1999; Landhäusser and Lieffers, 2002; Malaguti *et al.*, 2001; Regier *et al.*, 2010). The imbalance of carbohydrate reserves and re-growth capacity of poplars is directly affected by the different time period of above-ground disturbance. Previous studies (e.g. Landhäusser and Lieffers, 2002) found that the capacity of re-growth is much higher when plants are disturbed in autumn. Because in autumn carbon reserves in roots are higher than in spring after bud flush disturbance, a season that carbon reserves in roots are depleted.

Nitrogen status is a crucial factor and it is positively correlated to the high quantity and quality of re-growth (Bollmark *et al.*, 1999; Dong *et al.*, 2004; Malaguti *et al.*, 2001). The imbalance of N reserves has an effect on plant growth, particularly on the characteristics of re-growth plants. Cheng and Fuchigami (2002) found that when N was supplied to apple trees (*Malus domestica* Borkh.) in spring, N reserves played a role on the re-growth of new shoots in the following spring. They also found that at the end of re-growth period, apple trees which have high N reserves but low carbohydrate reserves produced larger total leaf area than trees with low N reserves and high carbohydrate reserves. In addition, Dong *et al.* (2004) confirm that the new growth of poplar cuttings in spring depended on the current N applied rather than on N reserves. In fact, poplar is fast growing specie. Therefore, it may require more N to support initial spring growth than N available from storage (Dong *et al.*, 2004). The results of Experiment I (the one-year scion poplars) confirmed such previous findings and suggested that N uptake before bud break on poplars affected the early development of new shoots.

Extend to the findings of Experimental I, the Experimental II focused on stump poplars, based on the assumption that the above-ground tissues and the disturbance source-sinks of stump poplars decrease when the poplars are cut to be the stump shape. The

Experiment II hypothesized that N supply before bud break increases N status and affects the development of re-growth. The Experiment I found that N uptake during bud break of the one-year scion poplars was positively correlated to calcium uptake. Such finding is consistent with the study of Lautner *et al.* (2007) where calcium plays an important role in the lignification process and wood compression formation in poplars. Moreover, Lautner and Fromm (2010) found that during bud flush and beginning of cell division of apical meristem, calcium is significantly increased. Accordingly, the second hypothesis of Experiment II was the modulation whether calcium uptake effects on N uptake before bud break and the quality of re-growth.

Both hypotheses were set to fulfil the aim of Experiment II, which used the two-year stump poplars of the common hybrid poplar (*Populus tremula* × *Populus alba*) and modalities of N and calcium nutrient supply using a recirculating nutrient solution. The parameters used to test the hypotheses are the dynamics of absorption mineral, the dynamics of growth and bud break, xylem sap pressure from before bud break, sap flow during the bud break, and the final compositions of the tissues with a focus on NSC and N. The Analysis of all these parameters and the global integration is to account for the variation in the development of re-growth at bud break and to propose explanation according to some of the underlying physiological mechanisms.

3.2.2 Materials and Methods

3.2.2.1 Plant Materials

Plant materials for this experiment are the two-year stump poplars (*Populus tremula* × *Populus alba*, clone INRA 717-1B4) originated from the *ex vitro* micro-cuttings. The poplar cuttings were cultivated to 1 liter pot that contains perlite, and then such trees were placed in greenhouse (natural photoperiod) in late summer 2008. Tree preparation in the greenhouse is divided into two stages:

The first stage of tree preparation was from late summer 2008 to October 2009. Trees were supplied with a mineral solution containing 0.1 g.L⁻¹ of multiple mineral nutrients Ilduclos[®] (19 % N, 8 % P₂O₅, 19 % K₂O, 2 % MgO, 0.0375 % B, 0.0075 % Cu, 0.0375 % Mn, 0.0038 % Mo, 0.03 % Zn and 0.09 % Fe) using the recirculation system. The recirculation system was an automatic flood-irrigated, recirculating for 15 minutes 4 times per day to ensure for the non-limiting supplied of water and nutrients. Then, trees were transferred to individual cylindrical containers (diameter × height = 0.20 × 0.30 m) on 13 May 2009. The containers

were firmed perlite and covered with a 1 cm thick layer of waterproof silex[®] to avoid evaporation and development of algae. Mineral nutrients and water were supplied by solution recirculation system, as automatic drip-irrigated with the 80 L nutrient solution. The system was recirculated for 1 hour six times per day to ensure the non-limiting supplied of water and nutrients. The composition of nutrient with nitrate and calcium (Table 3.7) was renewed every week. Main stem trees were cut to be 40-45 cm height on 20 May 2009. The cut induced axially bud break and growth to branch. Then, during summer, trees' branches were cut and exempted around 5-6 branches from top stem, remaining for growth during summer, while other undesirable branches were cut down.

The second stage was started six months later from the first stage. Poplars were pre-treated by cutting branches in autumn to produce stump shapes. On 1 October 2009, such branches were trimmed to be high 5-10 cm. At this stage, trees (with trimmed branches) are ready for undertaking experiment. They are called stump trees (Fig. 3.16). On 12 October 2009, such stump trees were sourced and separated into six solution recirculation systems. The stump trees were supplied with nutrient solution without nitrate and with calcium (Table 3.7). The solution was renewed every week until start experiment.

Treatments

There are six treatments of three stump poplars explored in this experiment and a solution recirculation system was used. In order to control N and calcium in nutrient solution that will be supplied to trees, 4 days prior to undertake the experiment three treatments (treatment 4, treatment 5, and treatment 6) were pre-prepared by changing nutrient solution without nitrate and without calcium composition (Table 3.7), to cleanup stored calcium in substrates. Greenhouse temperature was set at 15-20 °C a day before experiment. The experiment was initiated on 9 February 2010 (40th day of year 2010). Details of all six treatments are shown as follow:

- **Treatment 1:** trees were supplied with solution without nitrate and with calcium throughout the experiment period (*Control*). The solution was renewed weekly until the end of experiment ;
- **Treatment 2:** trees were supplied with two different solutions: **the first** solution containing nitrate and calcium was applied for seven days. Then, **the second** solution without nitrate but with calcium was applied throughout the experiment period. (*N-Pulse*). This solution was renewed weekly until the end of experiment;

- **Treatment 3:** trees were supplied with solution containing nitrate and calcium throughout the experiment period (*N-Supply*). The solution was renewed weekly until the end of experiment;
- **Treatment 4:** trees were supplied with solution containing no nitrate nor calcium throughout the experiment period (*Control-Ca*). The solution was renewed weekly until end the experiment;
- **Treatment 5:** trees were supplied with two solutions: **the first** solution containing nitrate but no calcium was applied for seven days. Then, **the second** solution without nitrate neither calcium was applied throughout the experiment period. (*N-Pulse-Ca*). The solution without calcium was renewed weekly until the end of experiment;
- **Treatment 6:** trees were supplied with solutions containing nitrate but no calcium throughout the experiment period (*N-Supply-Ca*). The solution was renewed weekly until the end of experiment.

Table 3.7 : Nutrient solution composition controls for N and calcium

	With nitrogen		Without nitrogen	
	With calcium mmol.L ⁻¹	Without calcium mmol.L ⁻¹	With calcium mmol.L ⁻¹	Without calcium mmol.L ⁻¹
NO ₃ ⁻	1.82	1.82	-	-
H ₂ PO ₄ ³⁻	0.19	0.19	0.19	0.19
SO ₄ ²⁻	0.24	0.24	0.66	0.54
Cl ⁻	-	-	0.97	0.81
K ⁺	1.00	1.41	1.00	1.00
Ca ²⁺	0.39	-	0.39	-
Mg ²⁺	0.35	0.54	0.35	0.54
Micro elements ¹				
Kanieltra [®]	0.2%	0.2%	0.2%	0.2%

¹Micro elements composition is 0.40% B, 0.30% Cu, 1.75% Fe, 0.30% Mn, 0.01% Mo and 0.30% Zn.

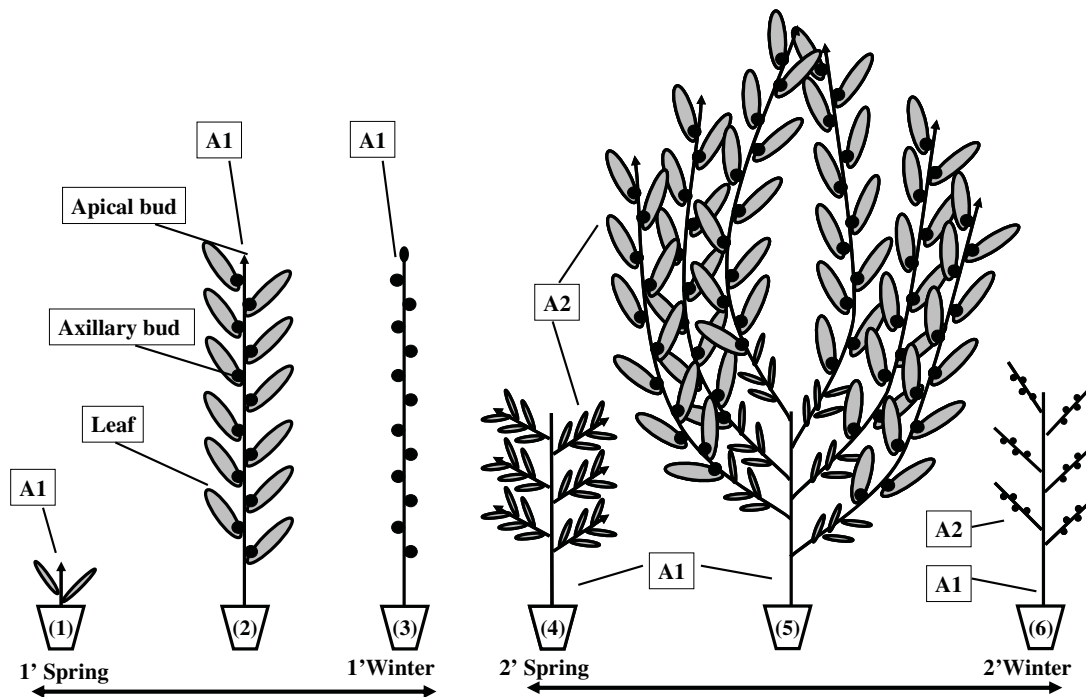

Fig. 3.16 : Scheme architecture of the two-years stump poplar. Poplar was propagated during early first spring (1). Poplar was grown until it produced leaves, axillary buds, and apical buds on main stem during summer to autumn (2). Leaves fell down and dormancy occurred during autumn to winter. Poplar showed axillary buds and an apical bud on main stem (3). During early second spring, axillary buds broke and new shoots became branches early than the breaking of apical buds. Then, main stem trees were cut to be 40-45 cm height and exempted around 5-6 branches from top stem, remaining for growth during summer, while other undesirable branches were cut down (4 and 5). During last autumn, such branches were trimmed to be high 5-10 cm. They are called stump trees (6).

3.2.2.2 Mineral Uptake

Nitrogen and mineral uptakes by plants were measured by indirect method. The net mineral uptake calculated the by the temporal variation of mineral quantity between initial and final ion content in nutrient solution (Beaujard and Hunault, 1996). In this experiment, nutrient solutions were collected by sampling the solution of 0.06 liter, and the volume of solution in tank was measured two times after watering for one hour, at 9.00 and 17.00. Such solution samples were analyzed on HPLC Metrohm Bioscan system (Metrohm France-91942 Courtaboeuf - France) with Metrosep C2 250 x 4.0 mm column for cations (K^+ , Ca^{2+} , Mg^{2+} and NH_4^+) and Metrosep A SUPP7 250 x 4.0 mm column for anions (NO_3^- , NO_2^- , HPO_4^{3-} , SO_4^{2-} and Cl^-). Then, the quantity of nutrient uptake by plants was estimated by the model of Beaujard and Hunault (1996) (Appendix 6.1).

3.2.2.3 Root Pressure

Root pressure was measured using the pressure transducer (Model 26PC Series Pressure Sensors, Honeywell LTD, USA,) connected to data loggers (DL2e; Delta-T Devices, Cambridge, U.K.) for data recording. The pressure transducer was connected to trees by using of stainless steel hypodermic needles and deionizer water to ensure link between pressure transducer and trees sap xylem (Beaujard, unpublished; Clearwater *et al.*, 2007) (Appendix 6.2).

3.2.2.4 Sap Flow

Sap flow was measured by the heat balance method. The method is based on the energy balance of a stem segment to which heat energy is supplied by external annular heater (Sakuratani, 1984). However, in this experiment the sap flow of stump poplars could not be always measured because after bud break is a period that whole trees contain small leaf areas. This experiment found that the stump poplars exhibited low transpiration (Appendix 6.3).

3.2.2.5 Plant Characteristics and Harvest

Two parts of stump trees were collected: main stems and branches. The stump trees were measured on 9 February 2010 (40 days of years 2010), at the experiment start before the application treatments (*Start*). Length and diameter of such main stems and branches of stump trees were recorded. In particular, for main stem measurement, the length and diameter of three parts were measured : base stem (height 5 cm), middle stem, and top stem (measure at 5 cm

lower the end of main stem), while branches were measured for length and diameter at their middle part.

Investigating whole plant characteristics concentrates on growth attributes: the time period of bud break, number of bud break, and the number of leaves. The bud break timing and number of bud break was collected every two days from the start to the end of experiment. Bud break was counted from the point where the first leaf was produced from bud scale. At the end of experiment, the number of leaves and leaf areas were recorded to investigate leaf growth attribute. The numbers of leaves were counted and leaf areas were measured by the leaf area meter (LI-30004 Portable Area Meter, LI-Cor, Inc.).

Plant harvest date in this experiment was divided into two periods: on 9 February 2010 before experiment start; and on 29 March 2010 (88 days of year 2010) after bud break. Four plant organs from different positions were sampled at each time: main stem, branch, root, and leaf. The treatment of plant harvest before starting experiment contains six sample plants.

For the second harvest, after bud break at the end of experiment, three plants per treatment were harvested. The samples of main stem were taken from base stem (height 20 cm) and top stem. The samples of branch were taken from middle part (branch number 1-3 from the base) and top part (branch number 4-6). Then, all samples from main stem and branch were measured for characteristics of interest: diameter, length, and weight before and after split off bark and xylem.

Root sample were separated in two groups: fine root (diameter ≤ 2 mm), and big root (diameter > 2 mm). Leaf samples were taken from the new shoots on middle branch and top branch of main stem. Then, all samples were placed in liquid N to stop enzymatic activity and stored at -75°C ; then waited until freeze-dried at -20°C . The dry weight of such samples was measured after freeze-drying and relative water content was estimated. They were then grounded to fine powder, and stored at room temperature. Other compartment tissues were dried on hot air oven at 75°C and the dry-weight of such tissues was collected.

3.2.2.6 Nitrogen Analysis

Nitrogen was extracted in *Control*, *N-Pulse*, and *N-Supply* conditions from main stem, branch, root, and leaf samples. Then, aliquots of 2-3 mg milled materials were weighted into tin cartouches (Hekatech, Wegberg, Germany) and N content was determined using the

Elemental analyzer EA1108 (Carlo Erba Strumentazione, Rodano, Milan, Italy). Atropine (4.816% N; Carlo Erba Strumentazione, Rodano) was used as a standard (Appendix 6.4).

3.2.2.7 Non Structural Carbon Analysis

Carbohydrate was extracted from *Control*, *N-Pulse*, and *N-Supply* treatments from main stems, branches, and root samples (30-50 mg). All parts were dried with 1.0 ml 80% ethanol at 80°C for 20 minutes, and then mixed and centrifuged at 12,000 rpm for 10 minutes. The supernatant was removed, and the pellet was re-extracted again. After that, all supernatants was combined. Supernatant and pellet were analyzed to measure soluble sugar and starch, respectively (Appendix 6.6).

3.2.2.8 Data Analysis

Data was analyzed as a completely randomized design with the level of N treatments. All data were subjected to the analysis of variance to determine the significance of difference between treatments. Differences between treatments were assessed by Duncan's multiple-comparison test at the 0.05 level of probability. Mineral uptake of plant was interpreted by using mean. All statistical analyses in this study were performed by using the Statistical Analysis System program (SAS).

3.2.3 Results

3.2.3.1 Environment Control

This experiment undertook in a greenhouse with controlled temperature and natural light (Fig.3.17c). One day before starting the experiment, the temperature inside greenhouse was reset as spring temperature. The temperature in greenhouse (Fig.3.17a) was increased at an average between 10.0°C to 15.9°C. The temperature of the substrate around roots, in the cylindrical containers was increased at an average between 10.4°C to 15.5°C (Fig 3.17b). In such temperature ranges, roots could well uptake nutrients as it was confirmed by the studies in apple (Dong *et al.*, 2001) and walnut (Ewers *et al.*, 2001).

3.2.3.2 Architecture before Start Experiment

Architecture of stump poplars before starting experiment showed that the volume of branch, main stem, and whole plant was not significant difference between treatments. The volume of middle branch, top branch, main stem, and whole plant was 7.4, 31.9, 155.6, and 1.95 cm³, respectively.

Table 3.8 : Volume of branch, main stem, and whole plant before start experiment of the two-year-stump poplars of *Start*, *Control*, *N-Pulse*, *N-Supply*, *Control/-Ca*, *N-Pulse/-Ca*, and *N-Supply/-Ca* treatments.

Volume cm ³	Branch		Main Stem	Whole Plant
	Middle	Top		
<i>Start</i>	9.8 ± 6.2	29.5 ± 14.4	148.2 ± 53.6	187.5 ± 70.1
<i>Control</i>	6.3 ± 3.0	29.8 ± 12.0	161.2 ± 20.6	197.2 ± 23.4
<i>N-Pulse</i>	3.4 ± 0.8	34.3 ± 2.8	159.8 ± 24.0	197.6 ± 25.8
<i>N-Supply</i>	8.2 ± 3.3	36.6 ± 7.5	153.9 ± 36.8	198.7 ± 39.6
<i>Control/-Ca</i>	12.5 ± 9.1	33.6 ± 15.8	150.5 ± 34.9	196.6 ± 57.1
<i>N-Pulse/-Ca</i>	4.8 ± 1.1	26.7 ± 8.9	166.8 ± 34.9	198.3 ± 43.8
<i>N-Supply/-Ca</i>	4.6 ± 2.9	35.4 ± 14.4	156.2 ± 26.4	196.2 ± 39.5
P-value	ns	ns	ns	ns

Data are means ± SD of 6 plants of *Start* and 3 plants of *Control*, *N-Pulse*, *N-Supply*, *Control/-Ca*, *N-Pulse/-Ca*, and *N-Supply/-Ca*

^{ns} non-significant

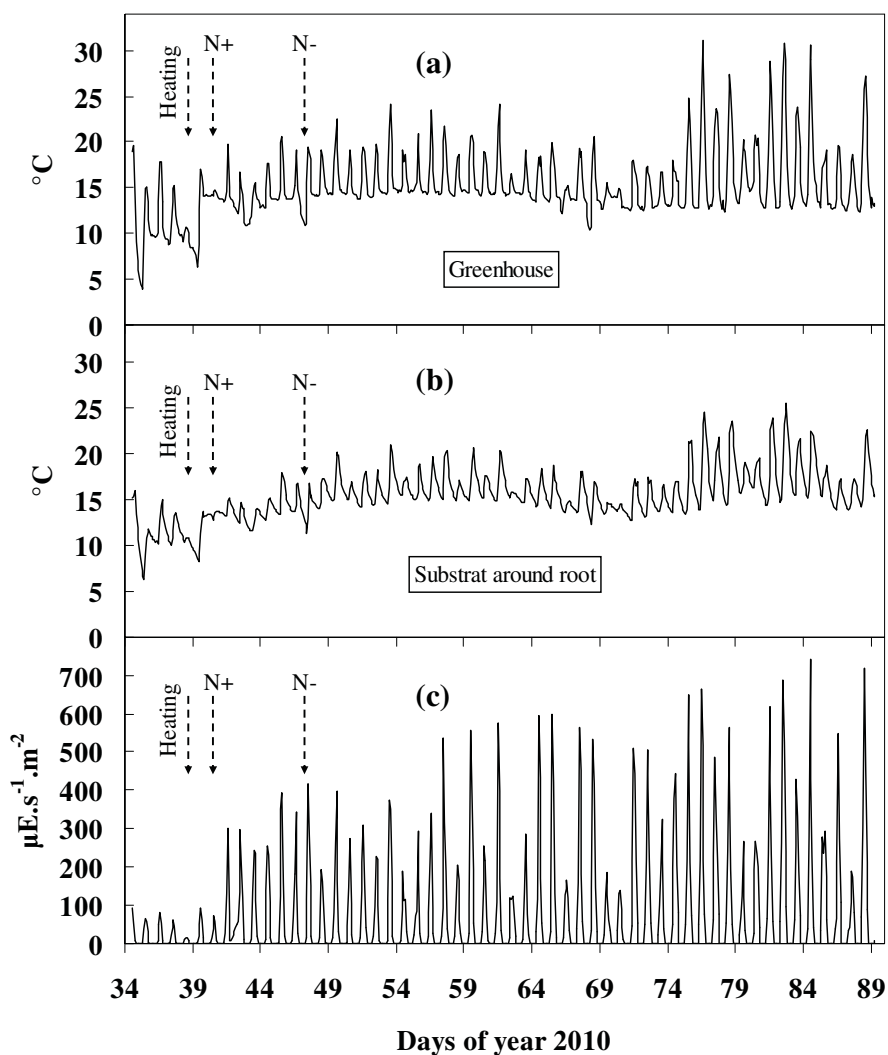

Fig. 3.17 : Environmental conditions during experiment period 2010. Temperature of greenhouse (a), substrate temperature around root in cylindrical containers (b), and light intensity in greenhouse (c). The arrows represent the time of increase temperature in greenhouse, starting experiment during solution supply with nitrate to *N-Pulse*, *N-Supply*, *N-Pulse/-Ca* and *N-Supply/-Ca* treatments (N+), and first time changing solution without nitrate to *N-Pulse* and *N-Pulse/-Ca* treatments (-N), respectively.

3.2.3.3 Nitrogen Uptake

The results of two-year-stump poplars confirm the hypothesis that N uptake was observed before bud break, similarly as in the one-year scion poplars. In addition, the dynamic curves of N uptake showed that stump poplars uptakes nitrate before bud break, independently on calcium uptake (Fig 3.18).

The N uptake curves of *N-Pulse* treatment showed the same information as the *N-Pulse/-Ca* schedule. Such *N-Pulse* and *N-Pulse/-Ca* curves showed that N uptake curves was dramatically increased when poplars was supplied with N solution. Then, the schedule of curves was changed due to the end of nitrate supply. As a result, plants did not uptake any N. At the end of experiment, the total N uptake in *N-Pulse* and *N-Pulse/-Ca* conditions was 0.60 and 0.64 g.plant⁻¹, respectively. Nitrogen uptake before bud break *N-Pulse* and *N-Pulse/-Ca* treatments was about 0.60 and 0.56 fold, respectively, when compared to the total N content in the whole plant tissue of *Start* experiment.

The trend curve of N uptake of *N-Supply* was same as the *N-Supply/-Ca* schedule. For both treatments before bud break, N uptake rose sharply for 12 days after applied nitrate. The N uptake *N-Supply* and *N-Supply/-Ca* condition was 1.07 and 1.21 g.plant⁻¹ during bud break. Then, N uptake slightly increased until the end of experiment after bud break. The total N uptake of *N-Supply* and *N-Supply/-Ca* was 1.22 and 1.35 g.plant⁻¹, respectively. In addition, the total N uptake of *N-Supply* and *N-Supply/-Ca* was about 1.15 and 1.27 fold, respectively when compared to the total N content in whole plant tissue *Start* conditions. However, the trend curve of N uptake of *Control* and *Control/-Ca* treatments took up no N.

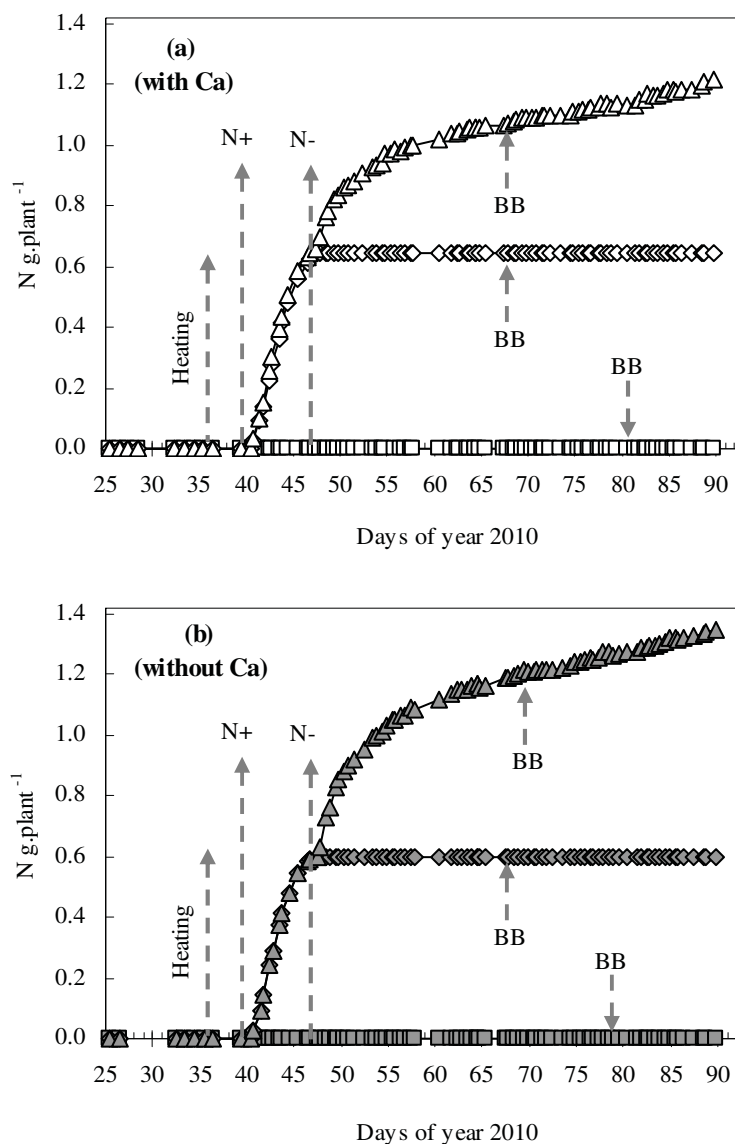

Fig. 3.18 : Accumulated N uptake (g.plant^{-1}) during the experiment period 2010, when supplied with solution containing calcium (a) in *Control* (\square), *N-Pulse* (\diamond), and *N-Supply* (Δ) conditions, containing no calcium (b) *Control/-Ca* (\blacksquare), *N-Pulse/-Ca* (\blacklozenge), and *N-Supply/-Ca* (\blacktriangle) conditions. The arrows represent the time of increase temperature in greenhouse, starting experiment supplying nitrate to *N-Pulse*, *N-Supply*, *N-Pulse/-Ca* and *N-Supply/-Ca* treatments (N+), first time change solution without nitrate to *N-Pulse* and *N-Pulse/-Ca* treatments (-N), and first bud break period (BB), respectively.

3.2.3.4 Root Pressure

Root pressure in treatments applying both nutrient solutions with and without calcium revealed the same information. The root pressure of *Control* and *Control/-Ca* was constant at zero until the end of experimental. For plants that were grown in the solution with nitrate, the root pressure was induced before bud break. The root pressure of *N-Pulse*, *N-Supply*, *N-Pulse/-Ca*, and *N-Supply/-Ca* increased dramatically when applying nitrate to plants before bud break. Such root pressures reached a maximum point after nitrate supply for 3 days, by 141-140 kPa (Fig. 3.19). Then, the root pressure of *N-Pulse* and *N-Pulse/-Ca* fell to the same level as *Control* before bud break. The root pressure of *N-Supply* and *N-Supply/-Ca* fell sharply and then increases dramatically again when nutrient solution was renewed. However, after renewing nutrient solution for 2 days, the root pressure of *N-Supply* and *N-Supply/-Ca* decreases steadily to be the same level as *Control* before bud breaks. After that, no root pressure was recovered, although the solution nutrient of *N-Supply* and *N-Supply/-Ca* was renewed every week until the end of experiment.

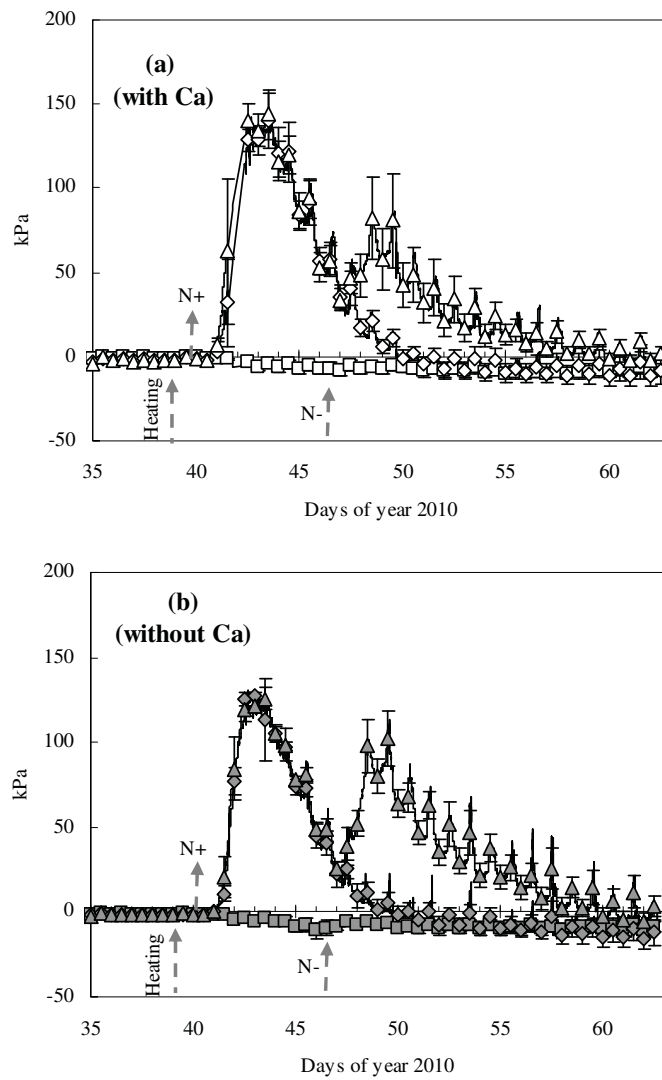

Fig. 3.19 : Root pressure (kPa) measurements during the experiment period 2010, with supplied solution containing calcium (a), in *Control* (\square), *N-Pulse* (\diamond), and *N-Supply* (Δ) conditions, when supplied solution contains no calcium (b) from *Control/-Ca* (\square), *N-Pulse/-Ca* (\diamond), and *N-Supply/-Ca* (Δ). The arrows represent the time of increase temperature in greenhouse (heating), start experiment during supply solution with nitrate to *N-Pulse*, *N-Supply*, *N-Pulse/-Ca*, and *N-Supply/-Ca* treatments (N+), and first time changing solution without nitrate to *N-Pulse* and *N-Pulse/-Ca* treatments (-N), respectively. The thick line represents the temperature in greenhouse (gray) during the experiment period. Values in panels *a* and *b* are means \pm SD of 3 plants.

3.2.3.5 Plant Architecture

Bud Break

The stages of bud break development are shown in Fig. 3.20 (Stage A-F). Fig. 3.20 presents the classification of bud break development by the characteristics of stump poplar. The bud break, in this experiment, was determined as bud developed to Stage C, the point where the first leaf starts to emerge from bud scale.

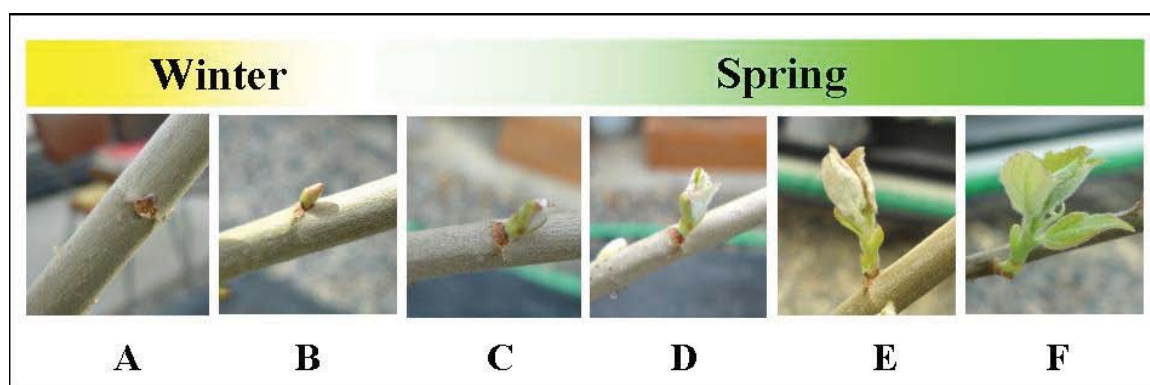

Fig. 3.20 : Bud break development stages A-F of stump poplar

Descriptions and illustrations of different stages are defined in the bud of a bud poplar sycamore.

Stage A: Bud at rest

Stage B: Opening of the first bud scale

Stage C: Bud break

Stage D: Small leaf internal lengthening: about 50%

Stage E: Small leaf internal lengthening: about 100%

Stage F: Leaves appearance

Bud Break Timing

Stump poplars up took N before bud break (*N-Pulse*, *N-Supply*, *N-Pulse/-Ca*, and *N-Supply/-Ca*) and induced bud break earlier than under *Control* and *Control/-Ca* conditions, about 12-14 days (Fig. 3.21a). At the end of experiment, the number of bud break of *N-Supply* and *N-Supply/-Ca* was 15-16 buds per plant and significantly higher than *N-Pulse/-Ca*, *Control*, and *Control/-Ca*, about 0.4-0.5 folds. However, the number of bud break in *N-Pulse* treatment was 13 buds per plant and it was not significant between treatments. The experiment showed different results when branches were separated into 2 groups: middle part (branch number 1-3) (Fig. 3.21b) and top part (branch number 4-6) (Fig. 3.21c). In stump poplars uptake N (*N-*

Pulse, *N-Supply*, *N-Pulse/-Ca*, and *N-Supply/-Ca* treatments), the middle part branch induced bud break before the top part. However, the middle part and top part of *Control* and *Control/-Ca* were not significantly different.

In addition, in middle part of *N-Pulse*, *N-Supply*, *N-Pulse/-Ca*, and *N-Supply/-Ca*, the first bud break occurred earlier than in *Control* by 14, 16, 14 and 12 days, and *Control/-Ca* by 12, 14, 12 and 10 days, respectively. For the top part branch of treatment in *N-Pulse*, *N-Supply*, *N-Pulse/-Ca*, and *N-Supply/-Ca* conditions, the first bud break was induced before than in *Control* by 8, 8, 2 and 10 days, respectively. *N-Pulse*, *N-Supply*, *N-Pulse/-Ca*, and *N-Supply/-Ca* treatments produced the first bud break before *Control/-Ca* by 6, 6, 0 and 8 days, respectively. At the end of experiment, the observed numbers of bud break of the middle part showed an insignificant difference between treatments. The numbers of bud break of those treatments were about 6-7 buds. Concerning the top part, the number of bud break of *N-Supply* and *N-Supply/-Ca* was higher than *N-Pulse/-Ca*, *Control* and *Control/-Ca* ($P < 0.01$). However, no significance between treatments was found when compared to *N-Pulse* conditions. In addition, the number of bud break of *N-Pulse* and *N-Pulse/-Ca* was tended to be higher than those for *Control* and *Control/-Ca* experiments.

Leaf Area and the Number of Leaf

Leaf area was measured at the end of experiment. The results showed that leaf area of *Control* and *Control/-Ca* could not be measured because the leaf area of new shoots was too small (Fig. 3.22a and 3.22d). While the leaf areas of *N-Pulse* and *N-Pulse/-Ca* were appeared at the middle part branch. They were higher than that of top part branch (Fig. 3.22b and 3.22e). The leaf area of *N-Supply* and *N-Supply/-Ca* was appeared at the middle and top part branch (Fig. 3.22c and 3.22f). The number of leaves, leaves dry weight, leaf area, and specific leaf area (SLA; $\text{cm}^2 \cdot \text{g}^{-1}$) of *N-Pulse*, *N-Supply*, *N-Pulse/-Ca*, and *N-Supply/-Ca* treatments was not significantly different between treatments (Table 3.9). The number of leaves per new shoot was around 3-5. However, the trend of the number of leaves, leaf dry weight, leaf area, and leaf ratio increased and the trend of those characteristics of *N-Supply* and *N-Supply/-Ca* was higher than *N-Pulse* and *N-Pulse/-Ca*.

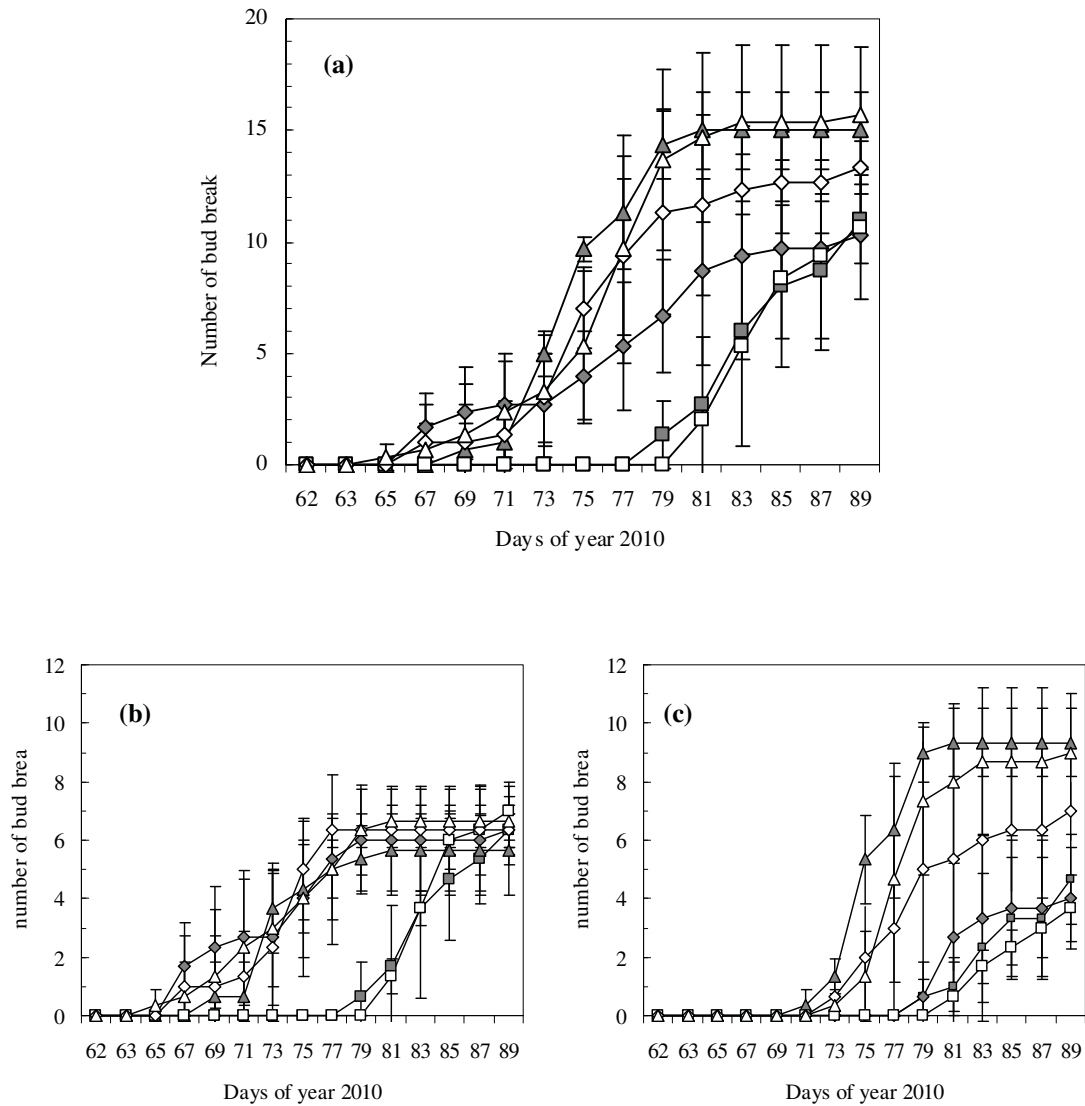

Fig. 3.21 : Time of bud break and number of bud break during the experiment period 2010 of whole plant (a), middle part of branch number 1-3 (b) and top part of branch number 4-6 (c), when supplied solution with calcium was applies in *Control* (□), *N-Pulse* (◇), and *N-Supply* (△) experiments, and when supplied solution without calcium was applies in *Control/-Ca* (■), *N-Pulse/-Ca* (◆), and *N-Supply/-Ca* (▲) conditions. Values in panels are means \pm SD of 3 plants.

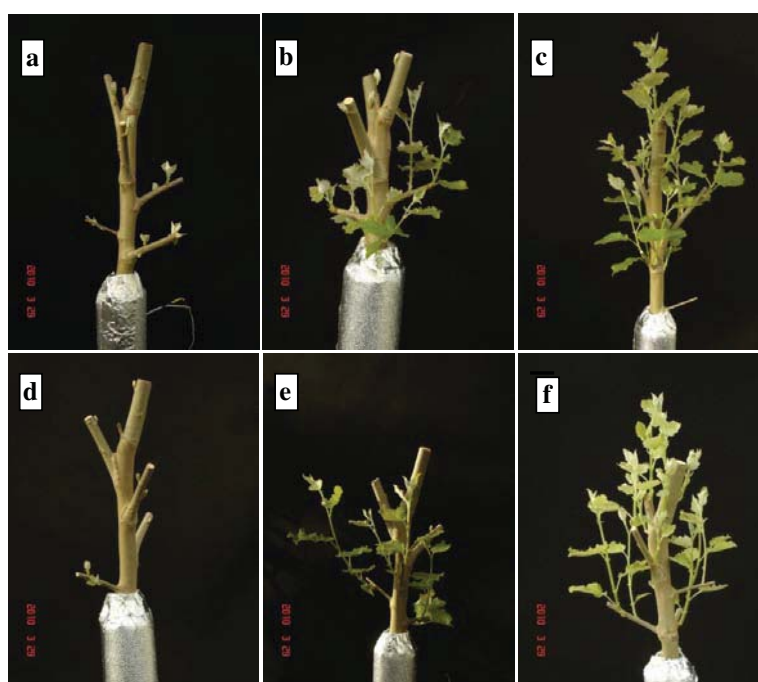

Fig. 3.22 : Plant photo during the end experiment 2010, when supplied solution containing calcium was applied to *Control* (a), *N-Pulse* (b), and *N-Supply* (c), respectively ; and when supplied solution without calcium was applied to *Control/-Ca* (d), *N-Pulse/-Ca* (e), and *N-Supply/-Ca* (f), respectively.

Table 3.9 : Numbers of leaf, dry weight of leaf, leaf area and leaf area ratio after bud break 2010.

	Number of leaf	Dry weigh of leaf (g)	Leaf area (cm ²)	Specific leaf area (cm ² .g ⁻¹)
<i>Control</i> ¹	-	-	-	-
<i>N-Pulse</i>	42.0 ± 16.7	1.7 ± 0.8	372.8 ± 194.7	219.6 ± 19.9
<i>N-Supply</i>	55.0 ± 22.6	2.7 ± 2.2	668.0 ± 621.5	226.0 ± 32.6
<i>Control/-Ca</i> ¹	-	-	-	-
<i>N-Pulse-Ca</i>	21.7 ± 13.8	1.1 ± 1.0	242.9 ± 232.9	204.0 ± 29.9
<i>N-Supply-Ca</i>	59.0 ± 4.6	2.5 ± 0.4	553.8 ± 164.5	220.2 ± 28.4
P-value	ns	ns	ns	ns

Data are means ± SD of three plants per treatment

^{ns} non-significant

¹*Control* and *Control/-Ca* could not be measured because the leaf area of new shoots was too small.

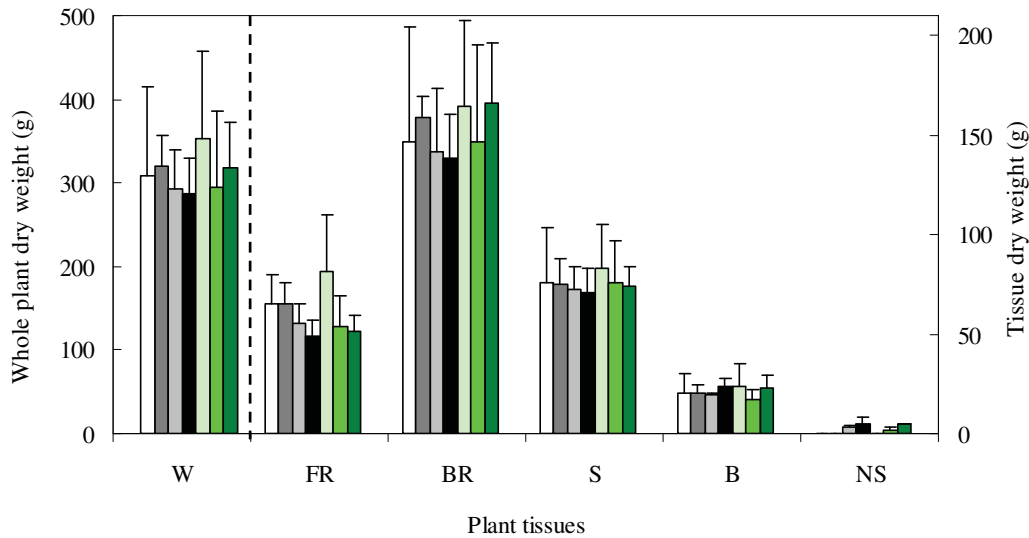

Fig. 3.23 : Plant tissue dry weight during the experiment period 2010 of whole plant (W), fine root (*FR* diameter ≤ 2 mm), big root (*BR*; diameter > 2 mm), stem (*S*), branch (*B*), and new shoot (*NS*) from *Start* (□), *Control* (■), *N-Pulse* (□), *N-Supply* (■), *Control/-Ca* (□), *N-Pulse/-Ca* (■), and *N-Supply/-Ca* (■) experiments. Values are means \pm SD of 6 plants for *Start* and 3 plants for *Control*, *N-Pulse*, *N-Supply*, *Control/-Ca*, *N-Pulse/-Ca*, and *N-Supply/-Ca* conditions.

Biomass

The biomass of whole plant before (*Start*) and after bud break (*Control*, *N-Pulse*, *N-Supply*, *Control/-Ca*, *N-Pulse/-Ca*, and *N-supply/-Ca*) was not significantly different (Fig. 3.23). For the above-ground and the below-ground of stamp poplars, it was observed that the biomasses before and after bud break of above-ground were lower than that of below-ground.

Analysis of biomass of plant tissue components showed that stem (*S*), branch (*B*), big root (*BR*), and fine root (*FR*) was not significantly different between treatments. However, the trend of biomass of stem, big root, and fine root was relatively low in *N-Pulse*, *N-supply*, *N-Pulse/-Ca* and *N-supply/-Ca* treatments. The new shoot biomass of *N-Supply* (4.94 g) and *N-Supply/-Ca* (4.55 g) was significantly different when compared to *Control* (0.14 g) and *Control/-Ca* (0.23 g) ($P < 0.01$), respectively. The new shoot biomass of *N-Supply* was higher than *Control* by 35 fold and the new shoot biomass of *N-Supply/-Ca* was higher than *Control/-Ca* by 20 fold. However, the new shoot biomass of *N-Pulse* (2.88 g) revealed insignificant difference between treatments. The new shoot biomass of *N-Pulse/-Ca* (1.87 g) was not significantly different when compared to *Control*, *N-Pulse*, *Control/-Ca*, *N-Pulse/-Ca*, and *N-supply/-Ca* experiments. However, such new shoot biomass of *N-Pulse/-Ca* was significantly

lower than *N-Supply* (Fig. 3.22). In addition, the trend of biomass of new shoots of *N-Pulse* and *N-Pulse /-Ca* was higher than *Control* and *Control/-Ca*.

3.2.3.6 Water Content

Water content of compartment tissues showed that the water content before bud break of *Start* was not significantly different to *Control* and *Control/-Ca* conditions. However, *Start* was significantly different when compared to stump poplars uptake N before bud break (*N-Pulse*, *N-Supply*, *N-Pulse/-Ca*, and *N-Supply/-Ca* treatments). Water content in compartment tissues of the stump poplars uptake N before bud break increased more than *Start*, especially for *N-Supply* and *N-Supply/-Ca* treatments.

In addition, the water content in stem xylem, xylem of middle part branch, bark of middle part branch, and xylem of top part branch in *N-Pulse*, *N-Supply*, *N-Pulse/-Ca*, and *N-Supply/-Ca* treatments was increasingly higher than in *Control* and *Control/-Ca* ones. Concerning stem bark, the water content of *N-Pulse*, *N-Supply*, and *N-Supply/-Ca* was increasingly higher than *Control* and *Control/-Ca*. But *N-Pulse/-Ca* was not significantly different to *Control* and *Control/-Ca*. For the bark of top part branch, water content of *N-Supply/-Ca* was significantly higher than *Control* and *Control/-Ca*. The water contents under *Control*, *Control/-Ca*, *N-Pulse*, *N-Supply*, and *N-Pulse/-Ca* conditions were not significantly different; however, the trend of water content in *N-Pulse*, *N-Supply*, and *N-Pulse/-Ca* was higher than in *Control* and *Control/-Ca* (Fig. 3.24).

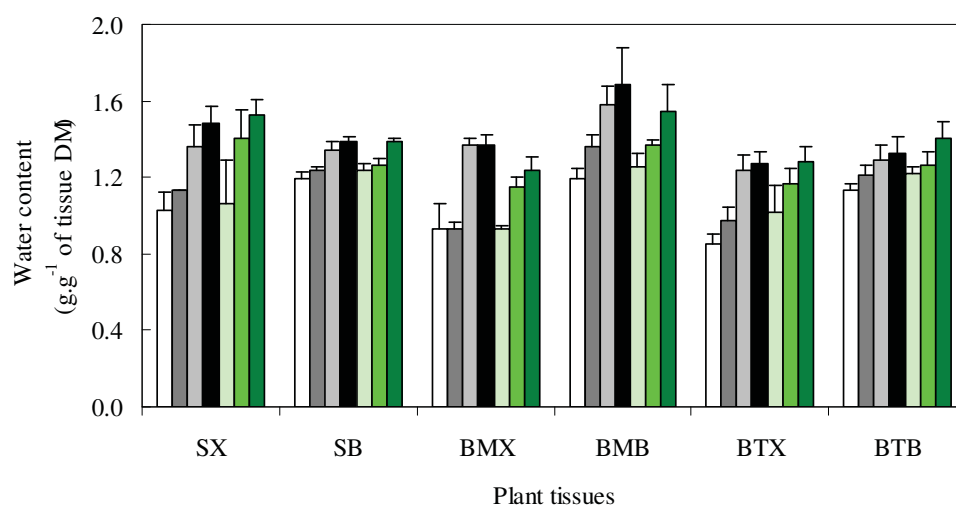

Fig. 3.24 : Water content of the tissues (g.g^{-1} of tissue DM) during the experiment period 2010 of stem xylem (SX), stem bark (SB), xylem of branch middle part (BMX), bark of branch middle part (BMB), xylem of branch top part (BTX) and bark of branch top part (BTB) from *Start* (□), *Control* (■), *N-Pulse* (■), *N-Supply* (■), *Control/-Ca* (□), *N-Pulse/-Ca* (■), and *N-Supply/-Ca* (■). Values are means \pm SD of 6 plants in *Start* conditions and 3 plants in *Control*, *N-Pulse*, *N-Supply*, *Control/-Ca*, *N-Pulse/-Ca*, and *N-Supply/-Ca* ones.

3.2.3.7 Nitrogen Content

Analysis of N content of the whole plant stump poplars showed that N content of the stump poplar before bud break (*Start*) was not significantly different from *Control* (Fig. 3.25). However, the N content of whole stumps increased by 0.22 fold in *N-Pulse* and by 0.51 fold in *N-Supply* as compared to *Control* which did not accumulate N ($P < 0.01$). This result confirms that stump poplar can uptake N before bud break and that such N accumulate in tissues.

Splitting analysis of the N content in compartment tissues, for each treatment, showed that N content in fine root in *Start* and *Control* was not significantly different between treatments. However, the N content of fine root in *N-Pulse* and *N-Supply* increases significantly ($P < 0.01$) higher than in *Start* (0.53 and 1.02 fold, respectively) and *Control* (0.41 and 0.86 fold, respectively). Nitrogen content in big root after bud break increases significantly ($P < 0.01$) higher than *Start*, especially for *N-Supply*. In addition, the N content of *N-Supply* was significantly higher than this of *Control* and *N-Pulse* by 0.23 and 0.14 fold, respectively. However, the N content of the big root of *N-Pulse* and *Control* was not significantly different.

The N content in stem xylem of *Control*, *N-Pulse*, and *N-Supply* samples was significantly higher than this from *Start*. Although the N content of *Control*, *N-Pulse*, and *N-Supply* treatments was not statistically significant, the trend of N content of stem xylem was high for the *N-Pulse* and *N-Supply* treatments. The N content of stem bark before bud break of *Start* was not significantly different with the *Control*, *N-Pulse*, and *N-Supply* treatments. However, the N content of stem bark of *N-Pulse* and *N-Supply* was lower than *Control*, by 0.21 and 0.19 fold respectively.

The N content in xylem of middle part branch for *Control*, *N-Pulse*, and *N-Supply* was significantly ($P < 0.01$) higher than *Start*. The *N-Supply* treatment induced N content significantly higher than *Control* and *N-Pulse*, by 0.25 and 0.22 fold, respectively. However, while the N content in *N-Pulse* was slightly higher than *Control* but the difference was not significant. The N content in the bark of middle part branch was not significantly different in *Start*, *Control*, and *N-Pulse* treatments. The N content of *N-Supply* was not different to that of *N-Pulse*, but it was significantly ($P < 0.05$) higher than those of *Start* and *Control* by 0.31 and 0.27 fold, respectively.

The N content in xylem of top part branch for *Control*, *N-pulse*, and *N-Supply* was significantly ($P < 0.01$) higher than *Start*. While the N content of *N-Supply* and *Control* was not significantly different, the N content of *N-Pulse* was significantly lower than that of *Control* by 0.21 fold. Nitrogen content in bark of top part branch for *Control* was significantly ($P < 0.05$) higher than for *Start* and *N-Pulse*, although the N contents of *Control* and *N-Supply* were not significantly different. Therefore, the trend of N content of top part branch after bud break was relatively low when plants were supplied with N before bud break, especially for the *N-Pulse* treatment.

Comparing the N content in new shoots of middle part was not significant between treatments. However, the trend of N content of middle part leaf was high when plants were supplied with N before bud break, especially in the case of *N-Supply*. For the top part, the N content of leaves in *Control* and *N-Pulse* experiments was not significantly different. In contrast, the N content of *N-Supply* was significantly higher than that of *Control*, by 0.36 fold.

Comparing N content in new shoots between treatments could not be clearly explained by this experiment's finding. This is because plants produced new shoots in each treatment, at different time period (Fig. 3.18). Then, the dry weight of new shoots of such treatments was initially unequal. Therefore, calculating the total N content in new shoots showed that the total N in the middle part of *N-pulse*, and *N-Supply* was higher than that of *Control* (20 and 47 folds)

and the total N in the top part of *N-pulse*, and *N-Supply* was higher than that in *Control* by 25 and 49 folds, respectively.

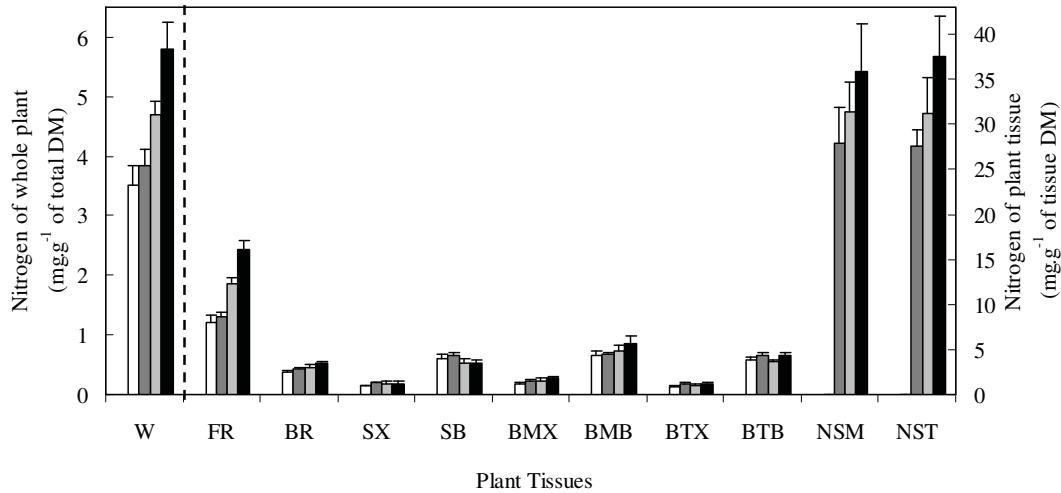

Fig. 3.25 : Nitrogen content of dry weight (mg.g^{-1} of tissue DM) during the experiment period 2010 in whole plant (*W*), fine root (*FR*; diameter ≤ 2 mm), big root (*BR*; diameter > 2 mm), stem xylem (*SX*), stem bark (*SB*), xylem of middle part branch (*BMX*), bark of middle part branch (*BMB*), xylem of top part branch (*BTX*), bark of top part branch (*BTB*), new shoot of middle part (*NSM*) and new shoot of top part (*NST*) of *Start* (\square), *Control* (\blacksquare), *N-Pulse* (\square) and *N-Supply* (\blacksquare). Values are means \pm SD of 6 plants of *Start* and 3 plants of *Control*, *N-Pulse*, and *N-Supply*.

3.2.3.8 Non Structural Carbon Content

The non structural carbon contents (NSC) (i.e. monosaccharide, sucrose, and starch) in below-ground was higher than in above-ground. The stump poplars storage NSC as starch was higher than as sucrose and monosaccharide, respectively. Comparing of the total NSC contents in the whole stump poplars without leaf to experimental treatments indicated a significant difference. The total NSC before bud break of *Start* was 161.11 mg.g^{-1} of dry weight decreases to 151.46 , 135.90 , and 123.88 mg.g^{-1} , respectively when comparing to *Control*, *N-Pulse*, and *N-Supply* after bud break (Fig. 3.26).

Starch

The starch content of whole stump poplars without leaf, before bud break, of *Start* was 89.40 mg.g^{-1} . However, it was not significantly different when compared to *Control* (90.09 mg.g^{-1}), *N-Pulse* (87.83 mg.g^{-1}), and *N-Supply* (83.14 mg.g^{-1}) conditions, after bud break (Fig.

3.26a). In below-ground, the starch content of fine root for *Control*, *N-Pulse*, and *N-Supply* were decreased significantly different ($P<0.01$) with *Start*. Starch content in *N-Supply* was significantly lower than in *Control*, by 0.40 fold. The starch content in big root for *Control*, *N-Pulse*, and *N-Supply* was relatively lower than that of *Start* but the differences were not significant. In contrast to such results, analyzing starch content in each tissue compartment of the above-ground showed that starch content increased after bud break, especially in *Control* treatment. For stem xylem, the starch content of *Control* and *N-Pulse* was significantly difference ($P<0.01$) and it was higher than *Start*, by 0.36 and 0.37 fold, respectively. However, comparing the starch content in stem xylem of *N-Supply* to *Start*, *Control*, and *N-Supply* did not show significant difference. For stem bark, the starch content for *Control*, *N-Pulse*, and *N-Supply* was significantly higher than in *Start* ($P<0.01$), by 8.43, 8.71, and 6.14 fold, respectively. In addition, the starch content in stem bark of *N-Supply* was significantly ($P<0.01$) lower than under *Control* and *N-Pulse* conditions.

The starch content in xylem and bark of middle part and top part branch after bud break in *Control*, *N-Pulse*, and *N-Supply* treatments increases significantly ($P<0.01$) higher than in *Start*. Comparing starch content from different treatments after bud break shows that starch content in xylem middle part branch of *N-Pulse* and *N-Supply* was lower than that of *Control* by 0.23 and 0.29 fold, respectively. Similar to starch content in bark middle part branch, of *N-Pulse* and *N-Supply* was lower than that of *Control*, by 0.16 and 0.36 fold, respectively. Despite the non significant difference in starch content in both xylem and bark of top part branch of *Control*, *N-Pulse*, and *N-Supply*, the trend of starch content in xylem and bark of top part branch was relatively low in *N-Pulse* and *N-Supply*.

Sucrose

The experiment found that sucrose content in the whole plant without leaf was significantly different ($P<0.01$). The sucrose content in the whole plant before bud break for *Start* was 65.14 mg.g⁻¹. However, after bud break such sucrose content for *Control*, *N-Pulse*, and *N-Supply* condition decreased to 57.72, 44.96, and 37.96 mg.g⁻¹, respectively (Fig. 3.26b). Comparing sucrose content of each compartment tissue revealed that sucrose content decreased after bud break, especially for *N-Pulse* and *N-Supply*. In fine root, sucrose content for *N-Pulse* and *N-Supply* was lower than that of *Start* (0.61 and 0.77 fold, respectively) and *Control* (0.30 and 0.58 fold, respectively). Sucrose content in big root from *N-Pulse* and *N-Supply* samples was lower than those from *Start* (0.23 and 0.34 fold) and *Control* (0.19 and 0.30 fold, respectively).

Sucrose content of the above-ground in stem xylem for *N-Pulse* and *N-Supply* was lower than in *Start* (0.53 and 0.52 fold) and *Control* (0.28 and 0.27 fold, respectively). For stem bark, sucrose content of *N-Pulse* and *N-Supply* was lower than in *Start* (0.35 and 0.44 fold) and *Control* (0.10 and 0.22 fold, respectively). Despite the sucrose content in xylem and bark of middle part and top part branch after bud break for *N-Pulse* and *N-Supply* treatments was slightly lower than *Control* but the difference was not significant.

Monosaccharide

The content of monosaccharide in the whole plant without leaf, before bud break (*Start*), was 6.58 mg.g⁻¹. After bud break, such content of *Control*, *N-Pulse*, and *N-Supply* decreased to 3.64, 3.10, and 2.78 mg.g⁻¹, respectively (Fig. 3.26c). Comparing monosaccharide content in compartment tissues showed that the monosaccharide content in below-ground after bud break decreased, especially in fine roots for *N-Pulse* and *N-Supply*. The monosaccharide content of these treatments was lower than *Control* by 0.52 and 0.72 fold, respectively. Although the monosaccharide content in big roots for *N-Pulse* and *N-Supply* treatments was slightly lower than *Control* but the difference was not significant.

Analysis of the monosaccharide content of the above-ground showed that the monosaccharide content in stem xylem and xylem of middle part branch after bud break such as *Control*, *N-Pulse*, and *N-Supply* was relatively low in *Start*, but all treatments were not significantly different. Monosaccharide content in xylem top part for *N-Pulse* was relatively higher than *Start*, and *Control* but the difference was not significant. However, the monosaccharide content in xylem top part of *N-Supply* was significantly higher than that of *Control* by 1.65 fold. Comparing the monosaccharide content in stem bark, bark of middle part and top part branches before bud break from *Start* found that it was significantly ($P < 0.01$) higher than in *Control*, *N-Pulse*, and *N-Supply* conditions. However, the monosaccharide content in stem bark, bark of middle part and top part branches after bud break of *Control*, *N-Pulse*, and *N-Supply* was not significantly different.

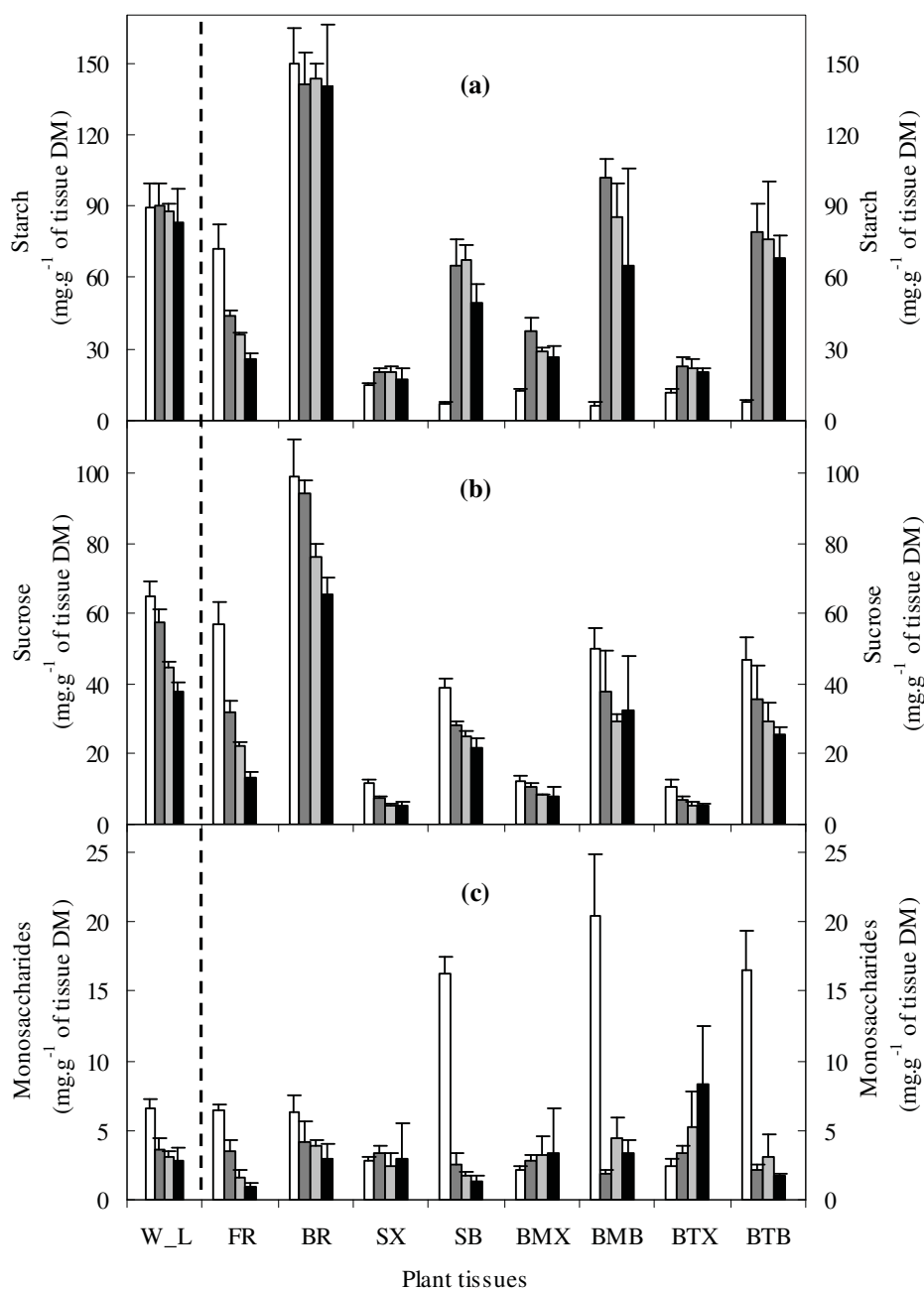

Fig. 3.26 : Non structural carbon content in plant tissues (mg.g^{-1} of tissue DM) during the experiment period 2010 was partitioned by starch (a), sucrose (b) and monosaccharide (c; glucose and fructose) among whole plant without leaves (*W_L*), fine root (*FR*), big root (*BR*), stem xylem (*SX*), stem bark (*SB*), xylem of middle part branch (*BMX*), bark of middle part branch (*BMB*), xylem of top part branch (*BTX*) and bark of top part branch (*BTB*) under *Start* (\square), *Control* (\blacksquare), *N-Pulse* (\square), and *N-Supply* (\blacksquare) conditions. Values are means \pm SD of 6 plants for *Start* and 3 plants for *Control*, *N-Pulse*, and *N-Supply* conditions.

3.2.3.9 Mineral Uptake

Four minerals were assessed for this experiment: potassium, phosphorus, calcium, and magnesium. Potassium uptake in stump poplars was not influenced by calcium supplied. Because the dynamic curves of plants grown supplied or not with calcium showed the same potassium uptake information (Fig. 3.27a and 3.27b). Potassium flowed out was depending on the N uptake during bud break. The stump poplars of *Control* and *Control/-Ca* uptake potassium during experiment period by 0.436 and 0.476 g.plant⁻¹, respectively. However, the results of *N-Pulse*, *N-Supply*, *N-Pulse/-Ca*, and *N-Supply/-Ca* showed that potassium was up taken for 3 days, from the first day, when plants were supplied with N, and then potassium was flowed out later. The dynamic curves of *N-Pulse* and *N-Pulse/-Ca* scheduled upward when solution without N was supplied. The dynamic curves indicated that *N-Pulse* and *N-Pulse/-Ca* were -0.104 and -0.070 g.plant⁻¹, respectively, until the end of experiment. The flow out of potassium from *N-Supply* and *N-Supply/-Ca* considerably increases for 10-12 days, and was then constant until the end of experiment, -0.498 and -0.529 g.plant⁻¹, respectively.

Concerning phosphorus, the phosphorus uptake in stump poplars showed that phosphorus was absorbed before and after bud break. Such phosphorus uptake was not dependent on calcium and N supply. At the end of experiment, stump poplars that were grown with calcium under *Control*, *N-Pulse*, and *N-Supply* treatments up took phosphorus by 0.121, 0.095 and 0.081 g.plant⁻¹, respectively (Fig. 3.27c). In this experiment, the stump poplars that were grown in solution without calcium (*Control/-Ca*, *N-Pulse/-Ca*, and *N-Supply/-Ca* treatments) up took phosphorus by 0.086, 0.076 and 0.072 g.plant⁻¹, respectively (Fig. 3.27d).

Experimenting on calcium uptake in the stump poplars that were grown in solutions with and without calcium shows that calcium flowed out from the start until the end of experiment. *Control*, *N-Pulse*, and *N-Supply* treatments showed that plants uptake N during bud break induced the efflux of calcium. The calcium efflux of *N-Pulse* and *N-Supply* was flowed out until the end of experiment. The calcium flowed out of both treatments was higher than under *Control* experiment, by 0.61 and 2.05 fold, respectively (Fig. 3.27e). The dynamic calcium uptake curves in the stump poplars that were grown without calcium indicated that calcium uptake of the *Control/-Ca*, *N-Pulse/-Ca*, and *N-Supply/-Ca* treatments flowed out until the end of experiment by -0.50, -0.50 and -0.49 g.plant⁻¹, respectively (Fig. 3.27f).

Magnesium was experimented on the stump poplars that were grown in solution with calcium. The experiment found that the efflux of magnesium depended on the N uptake of plants. For *N-Pulse*, magnesium was flowed out until the solution was altered from solution

with N to solution without N, and then the dynamic magnesium curves were constant until the end of experiment, by $-0.045 \text{ g.plant}^{-1}$. Concerning *N-Supply*, magnesium was flowed out from the start to the end of experiment, by $-0.133 \text{ g.plant}^{-1}$. For the stump poplars that were grown in solution with and without nitrate (*Control*), the dynamic curves were constant at 0 g.plant^{-1} until the end of experiment (Fig. 3.27g). In contrast, the magnesium uptake in stump poplars that were grown without calcium nor nitrate (*Control/-Ca*) showed that magnesium was up taken from the start to the end of experiment, by $0.233 \text{ g.plant}^{-1}$. In plants that uptake N (*N-Pulse/-Ca* and *N-Supply/-Ca*), magnesium was up taken for 3 days from the first day when N was supplied, and thereafter magnesium was flowed out. However, *N-Pulse/-Ca* samples re-took up magnesium again after stopping nitrate supply. Magnesium was continually up taken by *N-Pulse/-Ca* until the end experiment, $0.135 \text{ g.plant}^{-1}$. Magnesium uptake of the *N-Supply/-Ca* was flowed out until the end of experiment, $-0.124 \text{ g.plant}^{-1}$ (Fig. 3.27h).

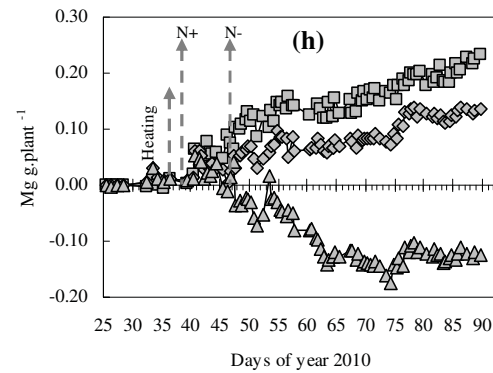
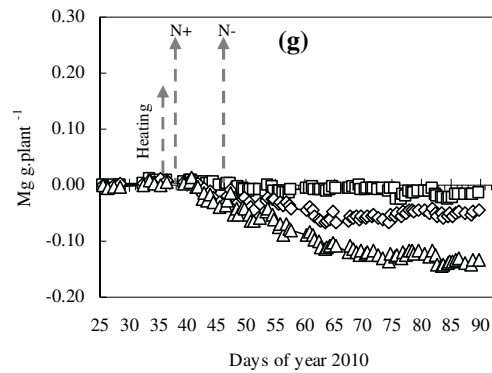
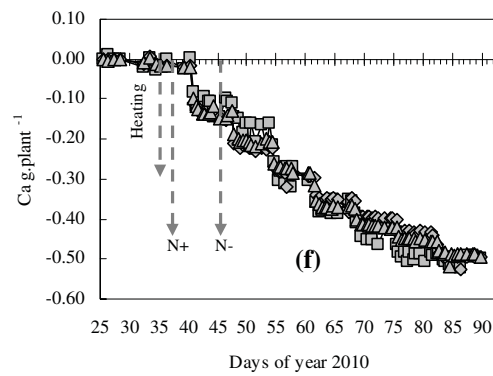
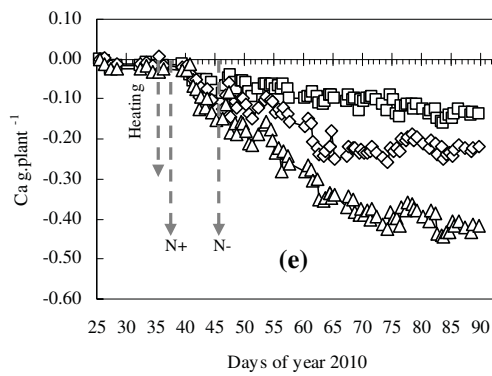
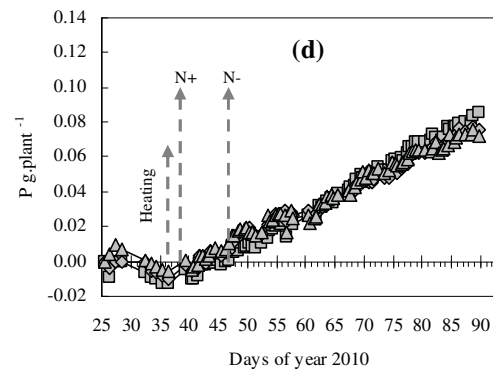
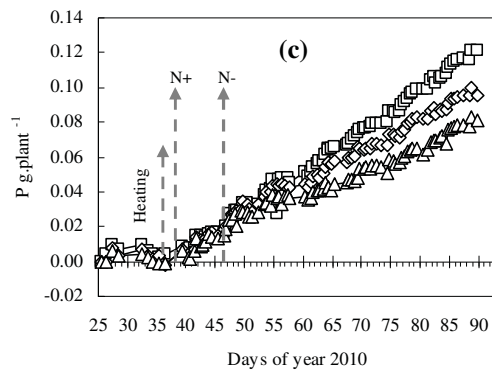
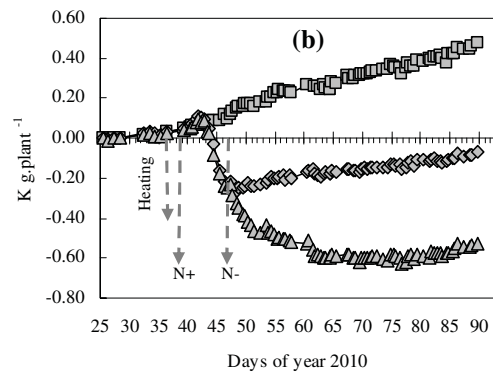
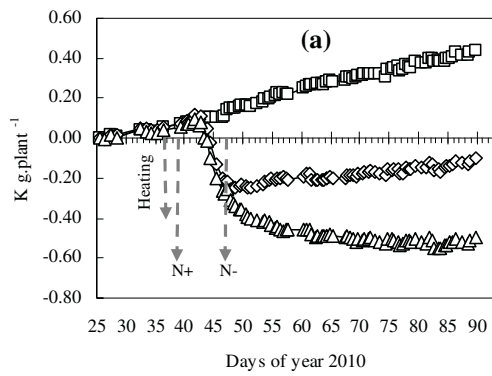

Fig. 3.27 : Cumulative potassium (a and b), phosphorus (c and d), calcium (e and f), and magnesium (g and h) uptake during the experiment period 2010, when calcium (a, c, e and g) was supplied to Control (□), *N-Pulse* (◇), and *N-Supply* (Δ), and when calcium (b, d, f and h) was not supplied to *Control/-Ca* (■), *N-Pulse/-Ca* (◆), and *N-Supply/-Ca* (▲).

The arrows represent the time of increase temperature in greenhouse (Heating), start experiment during nitrate supply to *N-Pulse*, *N-Supply*, *N-Pulse/-Ca*, and *N-Supply/-Ca* treatments (N+), and first time change solution without nitrate to *N-Pulse* and *N-Pulse/-Ca* treatments (-N), respectively.

3.2.4 Discussion

3.2.4.1 Nitrogen Uptake

In early seasons, re-growth of deciduous trees is supported by N remobilization from previous year reserves as well as N uptake. Most N remobilization occurs before there is much from root uptake. Investigated deciduous trees species include *Malus domestica* (Guak *et al.*, 2003) , *Prunus avium* (Grassi *et al.*, 2002), *Pryrus communis* (Tagliavini *et al.*, 1997), and *Sorbus aucuparia* (Malaguti *et al.*, 2001). However, the finding of this experiment is inconsistent with such statement. The experiment shows that stump poplars can uptake N before bud break and continually after bud break. In particular, N uptake was noticeably increased before bud break. Such result is consistent with the Experiment I made with the one-year- whip poplars. The result confirms the two previous studies on young maple trees (Delaire *et al.*, 2005) and one-year apples (Dong *et al.*, 2001). It is possible that poplar grows faster than many other trees; therefore, it may require more N to support initial spring growth than that available from storage.

However, this experiment revealed that N uptake in stump poplars was reduced during bud break, although they were supplied with nitrate throughout the experiment period (*N-Supply* and *N-Supply/Ca*). It is possible be because some parts of N uptake were changed to N compounds, such as ammonium and amino acid, and then accumulated in roots. Such N accumulation was little transported from below-ground to above-ground during the period when plants have high xylem pressure. Such transported N compounds resulted in sap leak before bud break period. Accordingly, the accumulation of N uptake in roots was more transported by xylem to other tissues until plants exhibited leaf transpiration (Dong *et al.*, 2001; Frak *et al.*, 2002; Guérin *et al.*, 2007; Millard *et al.*, 2006; Salaün *et al.*, 2005). Therefore, nitrate uptake before bud break is regulated by the whole plant demand and the feedback regulation of N compound accumulation in root tissues (Dluzniewska *et al.*, 2006; King *et al.*, 1993; Vidmar *et al.*, 2000).

3.2.4.2 Root Pressure

Root pressure of stump poplars was positively correlated to N uptake before bud break. This result is consistent which that found on the one-year scion poplars and walnut (Ewers *et al.*, 2001). Such positive root pressure increases water content (Fig. 3.24) and refills embolism in xylem during spring growth (Ameglio *et al.*, 2002; Ameglio *et al.*, 2001). In addition, high root pressure causes small sap leak in branches (Fig.3.28). Such situation may happen because

some biochemical substances (e.g. carbon and N compound) from roots were mobilized from below-ground to above-ground during the period when plants have high xylem pressure, and it results in sap leak before bud break period.



Fig. 3.28 : Nitrogen supply before bud break in *N-Pulse*, *N-Supply*, *N-Pulse/-Ca*, and *N-Supply/-Ca* treatments induced sap leak during the period 2010 that plants have high root pressure

3.2.4.3 Plant Development

Poplars were pre-treated, cutting branches in autumn to produce stump shapes. This cutting purposes to disturb the weight ratio of below-ground and above-ground of the stump poplars. The study found that the biomass of above-ground was lower than that of below-ground throughout the experiment period. However, the biomasses of below-ground after bud break decreased while that of above-ground increased, in relation to new shoot growth. In addition, this study showed that the biomass of new shoots of plants uptake N before bud break increased, and was higher than the plants which were not up taken N during bud break. This result confirms the findings of previous studies testing N uptake in various trees within different periods, such as increment N reserve in pioneer (*Salix viminalis*) (Bollmark *et al.*, 1999), N supply during re-growth in stock poplar (Dong *et al.*, 2004) and N supply before bud break of one-year scion poplar (the Experiment I). The results of this experiment (Experiment II) showed that N uptake before bud break increases the biomass of new shoots.

The biomass of new shoot also increases according to an effect of N which was up taken before bud break. Such N uptake induces early bud break, increases carbon assimilation, and increases new shoot growth. These results are consistent with the studies of Ripullone *et al.* (2003) and Cooke *et al.* (2005) showing that the increase of new shoot growth was affected by the N concentration increase in leaves. Such increased N concentration was positively correlated to chlorophyll concentration, leaf area, and the photosynthetic parameters as light-

saturated photosynthesis (A_{\max}), maximum carboxylation (V_{cmax}), and electron transport rate (J_{\max}).

The time of bud break of stump poplars depended on the N uptake before bud break. The N uptake before bud break impacted on the early spring bud break of stump poplars. However, the Experiment I found that uptake N before bud break had no effect on bud break time of the one-year scion poplars (See Experiment I). This may be due to two facts: the quality of buds, and the effect of sap xylem transportation before bud break. First, bud quality of poplars (stump poplars and one-year scion poplars) may lead to the different time period of bud break. From Experiment I, buds of the one-year scion poplars were broken between top- and medium-main stems. Between such places, plants have successive auxiliary bud formation that form bud scales stipule and small leaf lamina since the experiment has been started. The buds of stump poplars, however, were seen between below-branches. Such buds were small and some buds could not be seen even before the start of Experiment II (Fig.2.29). However, the buds were continuing developing and become new shoots later. With regard to these bud characteristics, some buds may partly develop their scales and meristematic tissue before the experiment.

Second, N uptake before bud break had substantial effect on the bud break time of stump poplars rather than that of the one-year scion poplars. Because the total N reserve of above-ground of stump poplars decreased, when they were pre-cut to produce stump shapes in autumn. Therefore, when stump poplar was supplied N before bud break and induced high root pressure, some store biochemical compounds (e.g. non structural carbon and N) in root were transported to above-ground due to xylem sap leak. It is reasonable to believe that the leak of xylem sap, which in turn resulted to the increase of non structural carbon and N content in the above-ground, and then such increased non structural carbon and N content, induced buds growth and development. Therefore, the stump poplars produced early bud break in spring.

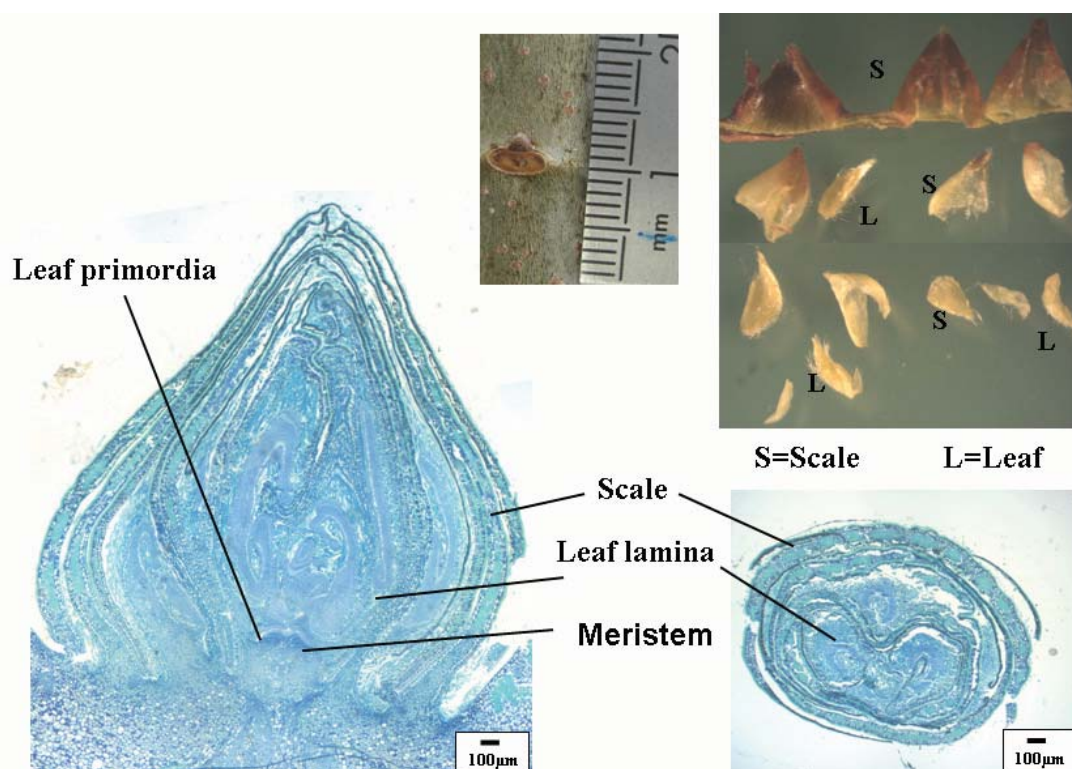

Fig. 3.29 : Morphology of axillary bud of stump poplars (*Populus tremula* × *Populus alba*, clone INRA 717-1B4) at the start of experiment 2010. Bud contents scale, small leaf, and meristem.

3.2.4.4 Nitrogen Content

Generally, stored N is remobilized to support new growth during spring. Thus, the decrease in N content of storing tissues such as root, stem, and branches is correlated to new growth during early spring (Bollmark *et al.*, 1999; Frak *et al.*, 2002). However, this study found that N contents in tissue compartments before and after bud break, when plants were grown without nitrate supply (*Control*), were not significantly different. Since N content of *Control* was measured 8 days after bud break and in that period the plants have very few leaves (Fig. 3.19a). Therefore, there was very low N (0.32% of total N) mobilized from storing tissue to new shoots after bud break.

When stump poplars were grown with N supply before bud break and throughout the experiment period (*N-Pulse* and *N-Supply*), it was found that N content in all tissue compartments of such stump poplars, in early spring, increases as an effect of N uptake, especially in fine roots and new shoots (Fig. 3.22). According to such N content increase in the new shoots, it is ambiguous that whether the N content increase in new shoots after bud break

(20-22 days) come from N uptake or/and stored N remobilization. In this experiment, N uptake and N remobilization to new shoots could not be separated. However, a number of studies in some tree species explained that roots N uptake begins during bud break and stored N remobilization is concomitantly available for bud and new shoots. Such tree species include deciduous *Jugulans nigra* × *J. regia* (Frak *et al.*, 2002), *Betula pendula*, evergreen *Pinus sylvestris* (Malaguti *et al.*, 2001), and *Ligustrum ovalifolium* (Salaün *et al.*, 2005). Dong *et al.* (2001) found that new shoots of the one year old apples can accumulate N from root uptake within the first 21 days after bud break (first measurement) when apples were up taken N before bud break.

In addition, the studies of Bollmark *et al.* (1999) in pioneer (*Salix Viminalis L.*), and Cheng and Fuchigami (2002) in apple (*Malus domestica* Borkh.), also found that new shoots in spring would contain high N correlated stored N remobilization from previous year. Accordingly, this study assumes that the new N uptake before bud break is accumulated in roots and has the same functions as previously stored N. Both remobilized and uptake N can be transported to compartment tissues because of the sap leak occurring before bud break and the transpiration of plants after bud break (Frak *et al.*, 2002; Glass *et al.*, 2002)

3.2.4.5 Non Structural Carbon Content

In poplar, stored carbon is used to support respiration and re-growth during winter, until carbon assimilation is recovered by the re-growth of new shoots. In winter, non structural carbon (NSC) reserves, as starch, in below-ground mainly supports re-growth (Regier *et al.*, 2010), especially when plants are disturbed above-ground (Bollmark *et al.*, 1999; Landhäusser and Loeffers, 2002). This study found that the NSC reserve in below-ground was higher than in above-ground throughout the experiment period. However, the total NSC content of stump poplars in below-ground decreased at the breaking and time of flush toward. The decrease of total NSC content in below-ground and the increase of NSC in above-ground of stump poplars can be explained within three dimensions of findings.

First, total NSC content in below-ground was used for fine root growth. This finding is consistent with the studies of Bollmark *et al.* (1999) and Landhäusser and Liefers (2003) who suggested that the total NSC content in below-ground decreased since the NSC of below-ground has been used for production and concurrent decay of fine roots. With regard to the production and concurrent decay of fine roots of the temperate tree species, fine root growth and mortality is strongly dependent on seasonal pattern. During spring, shortly before and after bud break, the new fine roots are highly reproduced while mortality of fine roots is low.

However, the fine root mortality is high in fall when leaves senesce (Curtis *et al.*, 2000; Miller *et al.*, 2007; Pregitzer *et al.*, 1990; Steele *et al.*, 1997). In poplars, the study of Coleman *et al.* (2000) found that the fine roots growth of hybrid poplar (*Populus tristis* × *P. balsamifera* cv ‘Tristis no. 1’) started since early spring. The growth increased exponentially until the mid of such growing season, then it decreased in fall and winter, respectively.

Second, this study also found that total NSC of below-ground decreased in response to the significant increase of the total NSC content in stems and branches; and the biomass of new shoots. This finding is consistent with the previous studies showing that NSC from below-ground was mobilized to above-ground to support re-growth (Bollmark *et al.*, 1999; Guérin *et al.*, 2007; Landhäusser and Lieffers, 2002; Regier *et al.*, 2010). In such period, however, plants use NSC as of monosaccharide and sucrose to support bud break and new shoots (Bonhomme *et al.*, 2009; Maurel *et al.*, 2004). Therefore, monosaccharide and sucrose within stems and branches decreased in early bud break, while starch increased. With regard to this result, it is possible that the mobilized NSC from below-ground to above-ground is excessive to support re-growth. Therefore, the excessive NSC mobilization accumulated in stems and branches as starch. Such accumulated starch could so be converted to sugar, supporting future shoot growth. This finding is consistent with the study of Landhäusser and Liefers (2003) showing that, 10 days before bud break in *Populus tremuloides*, the starch content in current shoots (one-year-old) and large branches increased and then, at bud flush, starch content in both current shoots and large branches later collapsed. In this study, however, the increase of NSC above-ground could not be supported by the carbon assimilation by new shoots. Because when data were collected, the new shoots were reproduced and had very small leaf areas. From such leaf characteristic, the carbon assimilation by new shoots is likely to be low. Therefore, it is impossible that carbon assimilated from new shoots could be sufficient and mobilized to increase the NSC within stems and branches (Fig. 3.22).

Finally, supplied N before bud break and throughout experimental period (*N-Pulse* and *N-Supply*) on stump poplars also affected on the NSC reserve in the compartment tissues of plants. In particular, the NSC content in compartment tissues after bud break of *N-Pulse* and *N-Supply* was lower than in *Control* conditions. This is because the NSC use by *N-Pulse* and *N-Supply* trees was greater than that of *Control*. *N-Pulse* and *N-Supply* utilized NSC for some activities. For example, plants invest greater energy in root production for nutrient capture, such as nitrate uptake, and N assimilation (Bloom *et al.*, 1992; de Visser *et al.*, 1986; Sasakawa and Larue, 1986) before bud break, and *N-Pulse* and *N-Supply* induced early bud break and enhanced the biomass of new shoots higher than *Control*. Hence, the NSC mobilization of *N-Pulse* and *N-Supply* was utilized to support the new shoots re-growth, higher than *Control*.

3.2.4.6 Mineral Uptake

A number of studies on plants mineral uptake propose that mineral uptake depend on the demand of plants and the environment around roots such as temperature, pH, water and available mineral (Imsande and Touraine, 1994; Ludovici *et al.*, 2002; Schmidt and Stewart, 1998). This study found that stump poplars can uptake phosphorus and potassium before bud break. Phosphorus was taken up independently while potassium uptake was disturbed by the nitrate supplied solution.

The dynamic curves of calcium net uptake in plants grown with calcium supply showed that calcium effused before bud break, especially when stump poplars were supplied with nitrate. While plants grown without calcium indicated that calcium effused independently and that such efflux was not related to the nitrate supply.

The dynamic curves of magnesium net uptake showed that magnesium effused before bud break when plants were grown with calcium. For the plants grown without calcium, the study found that stump poplars can uptake magnesium before bud break. However, when plants were supplied nitrate, the magnesium was effused.

The dynamic curves of potassium, phosphorus, calcium, and magnesium uptake in stump poplars were compared to the one-year scion poplars (Experiment I) when plants were supplied with calcium (*Control*, *N-Pulse*, and *N-Supply*). The study found that potassium and phosphorus uptake in stump poplars curves revealed similar trend with the one-year scion poplars. However, the dynamic curves of potassium and phosphorus uptake in stump poplars were lower than the one-year scion poplars. The trend of calcium and magnesium uptake curves of stump poplars and the one-year scion poplars was significantly different. The dynamic curves of stump poplars showed that calcium and magnesium net uptake was effused. In contrast, the curves of the one-year scion poplars showed that they can uptake calcium and magnesium before bud break.

The difference of dynamic curves of mineral uptake in stump poplars and the one-year scion poplars may be due to an effect of fine root turnover and root mortality influencing mineral uptake. Block *et al.* (2006) found that fine roots of poplars are relatively short lived and it was confirmed by several studies investigating on root longevity of plants, including Black *et al.* (1998) and Kosola *et al.* (2001). They found that the means longevity of fine root was 35 and 30 days, respectively, in *Populus canadensis* seedling. Coleman *et al.* (2000)

reported that the mean longevity of fine root in hybrid poplars (*Populus tristis* × *P. balsamifera* cv 'Tristis no. 1') was 149 days. For Experiment II, stump poplars were planted in cylinder pot for nearly two years; therefore, the fine root mortality of the stump poplars may be higher than the one-year scion poplars. As reported earlier, the mineral content of dead fine roots was leaked and resulted in an increase of nutrient in the solution, higher than the one-year scion poplars. Accordingly, this mineral efflux from dead fine root disturbed the final ion content in nutrient solution. In this study the net mineral uptake was calculated by the difference between initial and final ion content in nutrient solution after one hour supplying. Therefore, according to this method, the net uptake mineral decreased and flowed out. Such decrease was affected by the mineral efflux in response to the high fine root mortality.

According to the dynamic curves of nitrate, phosphorus, and potassium uptake in stump poplars, this study found that stump poplars can uptake such nutrients. These results indicated that the quantity of the nutrient influx in stump poplars was greater than nutrient effused from the dead roots. It is reasonable to assume that both stump poplars and the one-year scion poplars can uptake nutrients before bud break, particularly nitrate, phosphorus, and potassium. However, for calcium and magnesium uptakes, the dynamic curves showed that both nutrients were effused. Two explanations to clarify the calcium and magnesium efflux are: First, it is possible that nutrients influx in stump poplars was lesser than that of efflux from the dead roots. Second, it is possible that stump poplars did not uptake any calcium and magnesium before bud break. After the nutrients were infused to plants, they were effused suddenly. Therefore, the efflux of both calcium and magnesium uptake was reported in the dynamic curves.

In conclusion, the Experiment II's results support the hypothesis that the stump poplar (*Populus tremula* × *Populus alba*, clone INRA 717-1B4) can uptake N before bud break. In addition, the N uptake before bud breaks was not dependent on calcium uptake. These results, extend to N uptake before the bud break, had a significant effect on the increase of root pressure and the changes of NSC and N reserve. In addition, the N uptake before bud break impacted to induce the early spring bud break and increased the biomass of new shoots of stump poplars.

3.3 Experiment III:

Nitrogen Supply before Bud Break Influence on Early Spring Development of Poplars Dependent on Low Temperature during Winter

3.3.1 Introduction

Poplar (*Populus* spp.) is fast growth specie in response to fertilization, especially N availability (van den Driessche *et al.*, 2008; Yin *et al.*, 2009). The changes of N availability in poplars has an effect on several processes of plant growth, including light-saturated net photosynthesis, water-use efficiency and leaf area, and the change to whole-plant architecture, secondary xylem formation, and carbon accumulation (Coleman *et al.*, 2004; Cooke *et al.*, 2005; Pitre *et al.*, 2007; Ripullone *et al.*, 2003; Ripullone *et al.*, 2004). Therefore, nitrate may play a role on plant growth and development.

Experiments I and II found that poplars can uptake N before bud break by increasing quality and quantity of new shoot such as dry weight and N content. Both experiments were undertaken inside greenhouse. Experiment II, which was undertaken on stump poplars, found that when plants were supplied with N solutions before bud break, they produced early bud break. However, the effect of N uptake on timing of bud break is inconsistent with the Experiment I. Experiment I performed on the one-year scion poplars found that N supply before bud break did not exert any significant influence on timing of bud break. Differences of findings in both experiments may be due to the different size and development of internal structure of buds of material plants. Accordingly, Experiment III was undertaken in order to investigate the characteristics of plants by combine stump and main exist poplars in the same tree. Plant material of Experiment III was prepared by cutting stump poplars to have three branches. Each branch is 1 meter long (Fig. 3.27). It was assumed that each branch is a tree which contains same characteristics as the one-year scion poplar, or called reiteration (Barthélémy and Caraglio, 2007)

Experiment III extended to the scope of previous experiments by undertaken pre-experiment outside greenhouse during last winter with purpose to investigate external factors (i.e. temperature, light, and water) on plant growth and development of new shoot. Findings from this experiment could benefit for field study with big trees in the future. Experiment III focuses on temperature as one of the external factors on bud break of plants. The experiment investigates whether temperature during last winter inside and outside greenhouse effects on plant growth, i.e. bud break and development of new shoot, in response to N uptake.

Generally, outside greenhouse temperature was lower than inside greenhouse in winter (Fig. 3.28). A number of studies evidence that low temperature and its time duration from late fall to the end of winter play a role on dormancy release of some species of temperate trees. For example, strong relationship between winter temperature and dormancy release implies that even small change in winter temperature could have large impacts on the timing of bud break in spring (Heide, 2003; Linkosalo *et al.*, 2006; Myking, 1999; Myking and Heide, 1995; Partanen *et al.*, 1998; Yu *et al.*, 2010). Warm autumn temperature has been shown to induce deep dormancy development. Those affect bud break delay in northern ecotypes of birch (*Betula* sp.) (Heide, 2003). Myking and Heide (1995) found that bud break of birch (*Betula* sp.) was normal in seedlings over wintered at 12°C, but was erratic and delayed in seedlings over wintered at 15°C and especially at 21°C.

Accordingly, Experiment III hypothesized that whether poplars grown inside and outside greenhouse in last winter uptake N before bud break and whether such N uptake influences on growth and N content of new shoots. Experiment III used the two-year poplars of the common hybrid poplar (*Populus tremula* × *Populus alba*). Plants were grown under different temperatures from autumn to winter, then moved and placed in the same greenhouse condition and modalities of N nutrient supply during experiment period. The parameters used to test the hypothesis are the dynamics of absorption mineral, the dynamics of growth and bud break, and the final compositions of compartment tissues, focusing on water content of main stem and N content of new shoot. Analysis each of these parameters and their integration purposes accounting for the variation in the development of re-growth at bud break period and to propose explanations underlying the physiological mechanisms.

3.3.2 Materials and Methods

3.3.2.1 Tree Preparation

The two-year-old poplars (*Populus tremula* × *Populus alba*, clone INRA 717-1B4) originated from the *ex vitro* micro-cuttings were used. Trees were planted in greenhouse. Tree preparation can be divided into three stages (Fig. 3.30): **The first stage** of tree preparation is from August 2009 to 3 November 2010 (307 days of year 2010). Poplars were propagated by *ex vitro* micro-cuttings one month. Then, main stem trees were cultivated to one liter pots that contain perlite. Such trees were placed inside greenhouse (natural photoperiod) in late summer 2009. During the first stage, trees were supplied with water and mineral solution containing 0.1 g.L⁻¹ of multiple mineral nutrients Ilduclos[®] (19% N, 8% P₂O₅, 19% K₂O, 2% MgO, 0.0375% B, 0.0075% Cu, 0.0375% Mn, 0.0038% Mo, 0.03% Zn and 0.09% Fe) by recirculation system.

The recirculation system was automatic flood-irrigated and recirculating for 15 minutes 4 times a day to ensure non-limiting supplied of water and nutrients.

In May 2010, trees were transferred to individual cylindrical containers (diameter \times height = 0.20 \times 0.30 m) that contain perlite. Mineral nutrients and water were supplied by automatic drip-irrigated. Trees were supplied with mineral solution, 0.15 g.L⁻¹ of the multiple mineral nutrients IIDuclos[®]. Such system supplied water and nutrient on trees for 10 minutes, 6 times a day, to ensure the non-limiting supplied of water and nutrients. In order to induce axial bud break and growth to branch, trees were trimmed main stem to be around 30-40 cm height. Then, during summer, undesirable branches of such trees were cut except three branches one branch was kept at top part of main stem, one at middle part, and one at base. Such branches remained for growth during summer. On 27 October 2010 (283 days of year 2010), such three branches were trimmed to be 100 cm high (Fig. 3.31a).

The second stage on 3 November 2010 (307 days of year 2010), was the experimental pre-treatments preparation by sourcing plants into two groups. The first group contains six plants remaining planted inside greenhouse. Another six plants, the second group, were moved and placed outside greenhouse until 15 February 2011 (46 days of year 2011) (Fig. 3.31b). In these conditions, both groups of plants were grown under different temperature during autumn and winter. Temperature of outside greenhouse (Fig. 3.32a) was lower than the temperature of inside greenhouse (Fig. 3.32b)

The third stage of tree preparation started on 15 February 2011 (46 days of year 2011). In this stage, both groups of plants were moved and placed in same greenhouse with the solution recirculation system. The preparation of trees was done in greenhouse with temperature set between 15-20°C a day (Fig 3.32c). Plants from the first group were separated into two sub-groups, three plants each and then placed in the solution recirculation systems (three plants per a system). The second group of plants (placed outside greenhouse in the first stage) were separated into two sub-groups, three plants each sub-group into the solution recirculation system. The system supplied solution nutrient without nitrate to all four sub-groups for one hour six times a day to ensure the non-limiting supplied of water and nutrients (Table 3.10). The solution was renewed every week until start experiment.

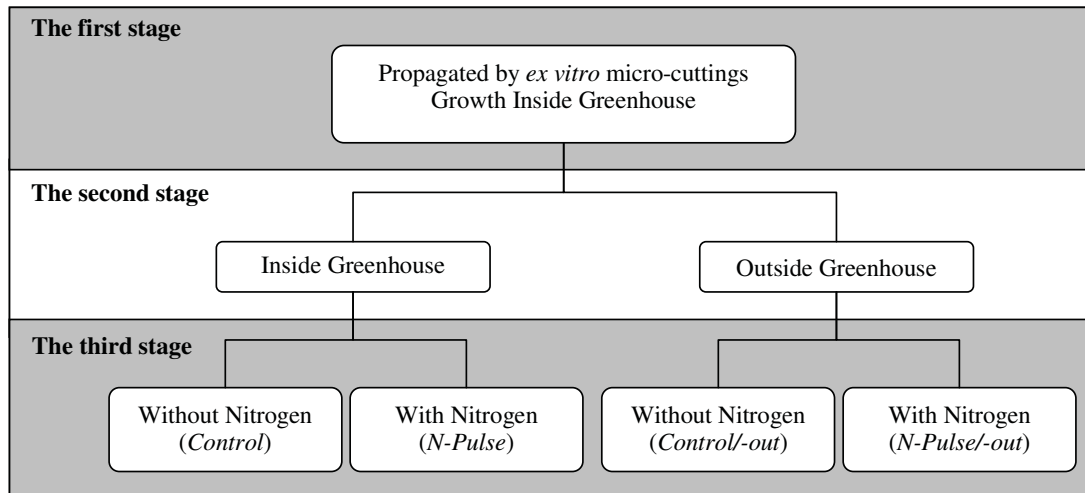

Fig. 3.30 : Scheme of plant preparation during the experiment period 2011. The first stage (August 2009 to 3 November 2010) three branches of plants were prepared inside greenhouse. The second stage (3 November 2010-15 February 2011) separated plants into two groups during late autumn to winter: inside greenhouse group, and outside greenhouse group. The third stage (15 February 2011), the started experiment were moved and placed both groups of plants in same greenhouse with the solution recirculation system. Then, divided the inside greenhouse group into two sub-groups: without (*Control*) and with N supply (*N-Pulse*), and also divided the outside greenhouse group into two sub-groups: without (*Control/-out*) and with N supply (*N-Pulse/-out*).

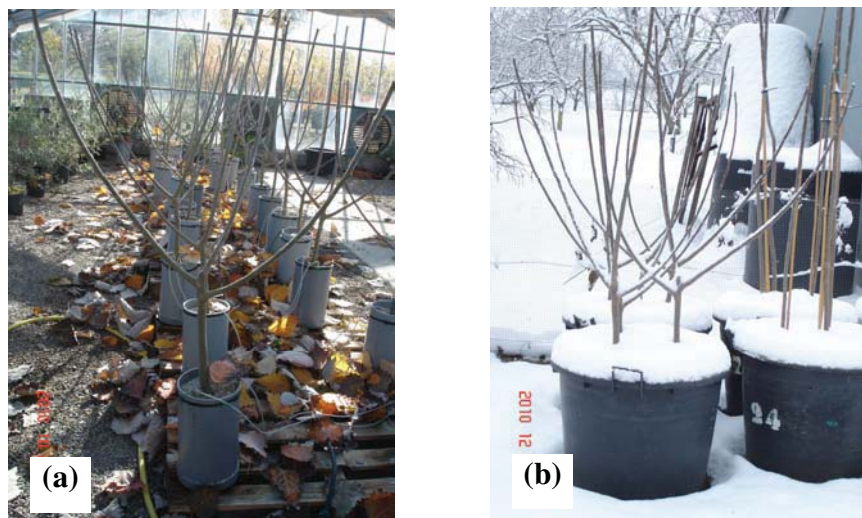

Fig. 3.31 : Poplars were prepared three branches from top (base, middle, and top branches) (a). The experimental pre-treatments were prepared by moving six plants outside greenhouse (b) and other six plants were placed inside greenhouse (under natural photoperiod).

Treatments

In order to control N supplied on plants (with nitrate and without nitrate treatments) (Table 3.10), this experiment contains four treatments according to a factorial design. Those four treatments combination are two factors of the two pre-treatments of last winter temperature factors and the two nutrient solution factors (Fig3.30). Details of the four treatments are shown as follow:

- **Treatment 1:** pre-treatment plants remained inside greenhouse during last winter and did not receive nitrate throughout the experiment period (*Control*). The solution was renewed weekly until the end of experiment;
- **Treatment 2:** pre-treatment plants remained inside greenhouse during last winter and they were supplied with two different nutrient solutions during the experiment period: **the first** solution with nitrate was applied for seven days. Then, after that **the second** solution without nitrate was applied throughout the experiment period. (*N-Pulse*). This solution was renewed weekly until the end of experiment;
- **Treatment 3:** pre-treatment plants remained outside greenhouse during last winter and did not receive nitrate throughout the experiment period (*Control/-out*). The solution was renewed weekly until the end of experiment;
- **Treatment 4:** pre-treatment plants remained outside greenhouse during last winter and they were nutrient supplied with two different solutions during the experiment period: **the first** solution with nitrate was applied for seven days. Then, **the second** solution without nitrate was applied throughout the experiment period. (*N-Pulse/-out*). Solution was renewed weekly until the end of experiment;

The experiment was initially started on 21 February 2011 (52 days of year 2011). Two control treatments (treatment 1 and treatment 3) were placed together in the same solution recirculation system (6 plants/system). The other treatments were placed in the solution recirculation system separately (3 plants/system).

Table 3.10 : Nutrient solution composition control nitrogen

mmol.L ⁻¹	Without nitrogen mmol.L ⁻¹	With nitrogen mmol.L ⁻¹
NO ₃ ⁻	-	1.82
H ₂ PO ₄ ³⁻	0.19	0.19
SO ₄ ²⁻	0.66	0.24
Cl ⁻	0.97	-
K ⁺	1.00	1.00
Ca ²⁺	0.39	0.39
Mg ²⁺	0.35	0.35
Micro elements ¹ Kanieltra [®]	0.2%	0.2%

¹Micro elements composition is 0.40% B, 0.30% Cu, 1.75% Fe, 0.30% Mn, 0.01% Mo and 0.30% Zn.

3.3.2.2 Mineral Uptake

Nitrogen and mineral uptake of plants was measured by sampling of solutions, 0.06 liter, and solution volume in tank was measured after watering one hour at 09.00. Such solution samples were analyzed on HPLC Metrohm Bioscan system (Metrohm France-91942 Courtaboeuf - France) with Metrosep C2 250 x 4.0 mm column for cations (K⁺, Ca²⁺, Mg²⁺ and NH₄⁺) and Metrosep A SUPP7 250 x 4.0 mm column for anions (NO₃⁻, NO₂⁻, H₂PO₄³⁻, SO₄²⁻ and Cl⁻). Then, the quantity of nutrient uptake by plants was estimated by the model of Beaujard and Hunault (1996) (Appendix 6.1).

The dynamic curves of mineral uptake of *Control* and *Control/-out* treatments were similar because both treatments were grown by placing together within the same solution recirculation system. So nutrient uptake of *Control* and *Control/-out* could not be separated; therefore, calculated mineral uptake of such treatments was equally averaged. However, for other treatments (*N-Pulse* and *N-Pulse/-out*), they were separately placed in the solution recirculation system. Therefore, mineral uptake of them was calculated separately.

3.3.2.3 Plant Characteristics and Harvest

The characteristics of interest for poplars were measured on 15 February 2011, at start experiment before the application nutrient solution factors. Length and diameter of such main stems and branches of stump trees were recorded. In particular, for main stem measurement, the length and diameter of three parts were measured: base stem (height 5 cm), middle stem,

and top stem (measure at 5 cm lower the end of main stem), while branches was measured for length and diameter of base (height 5 cm), middle and top (measure at 5 cm lower the end of branch) of branches. The data was calculated to find the volume of poplar at the start experiment.

Plant characteristics of interest during experiment are the new growth attributes : bud break timing, and numbers of bud break. Data of bud break timing and numbers of bud break was collected everyday from the start to the end of experiment. Bud break was measured by counting from the point when first leaf produced from bud scales.

Plant harvest date in this experiment was on 1 April 2011 (91st day of year 2011) after bud break. Two plant organs from different positions were sampled: main stem and new shoot. The samples of main stem were taken from middle stem (height 20 cm from trees' base). They were then measured for diameter, length, and weight, before and after split off bark and xylem. All samples were dried in hot air oven at 75°C for 4 days and dry weight of such tissues was collected and the data was calculated to find water content. New shoots were taken from the base, middle, and top branches. Then, all samples were dried in hot air oven at 75°C for 4 days. The dry weight of such tissues was collected, and samples were grounded for nitrogen content analyses.

3.3.2.4 Water Content

The water content was calculated from samples of main stem and split off bark and xylem. The wet weight (WW, g) and dry weight (DW, g) of bark and xylem from main stem were calculated to find water content (WC, g.g⁻¹). The water content of samples was calculated by the formula shown below:

$$WC = \left(\frac{WW - DW}{DW} \right)$$

3.3.2.5 Nitrogen Analysis

Nitrogen was extracted from new shoot samples. Aliquots of 2-3 mg milled materials were weighed into tin cartouches (Hekatech, Wegberg, Germany) and nitrogen was determined by the Elemental analyzer EA1108 (Carlo Erba Strumentazione, Rodano, Milan, Italy). Atropine (4.816% N; Carlo Erba Strumentazione, Rodano) was used as a standard (Appendix 6.4).

3.3.2.6 Data Analysis

Data was analyzed as a randomized block 2×2 factorial design with two levels of nitrogen and two levels of temperature during winter. All data were subjected to the analysis of variance to determine the significance of difference between treatments. Differences between treatments were assessed by Duncan's multiple-comparison test at the 0.05 level of probability. Mineral uptake of plant was interpreted by using mean. All statistical analyses in this study were performed by using the Statistical Analysis System program (SAS).

3.3.2 Results

3.3.3.1 Architecture at Start Experiment

Architecture of poplars at starting experiment before the application nutrient solution factors showed that the volume of main stem, branch, and whole plant was not significantly different in combination treatments (*Control*, *Control/-out*, *N-Pulse*, and *N-Pulse/-out*). The volume of main stem, base branch, middle branch, top branch, and whole plant was 216.9, 113.2, 136.1, 162.2, and 628.3 cm³, respectively (Table 3.11). However, in the absence of treatment separation, the volume of top branch was higher than that of base and middle branches, by 0.4 and 0.2 fold, respectively. Branch locations (top, middle or base) were considered as blocks in a randomized design. (factorial experiment using randomized complete block design (RCBD)) analyzing an effect of nitrogen and temperature factors on timing of bud break, dry weight, and nitrogen content of new shoots have to block an influence on the differentiation of the volume of branches.

Table 3.11 : Volume of main stem, branch, and whole plant at start experiment 2011 before the application nutrient solution factors of poplars of *Control*, *Control/-out*, *N-Pulse*, and *N-Pulse/-out*

Volume cm ³	Main stem	Branch			Whole plant
		Base	Middle	Top	
<i>Control</i>	216.5 ± 70.6	119.9 ± 20.6	130.5 ± 39.3	147.2 ± 30.0	614.0 ± 111.0
<i>Control/-out</i>	207.7 ± 36.5	106.9 ± 17.1	125.8 ± 18.4	181.1 ± 42.5	621.6 ± 72.1
<i>N-Pulse</i>	257.5 ± 22.4	111.4 ± 31.7	146.1 ± 7.8	153.0 ± 36.5	668.0 ± 38.4
<i>N-Pulse/-out</i>	185.8 ± 30.4	114.7 ± 24.5	141.8 ± 55.0	167.3 ± 25.0	609.6 ± 85.8
P-value	ns	ns	ns	ns	ns

Data are means ± SD of 3 plants

^{ns} non significance

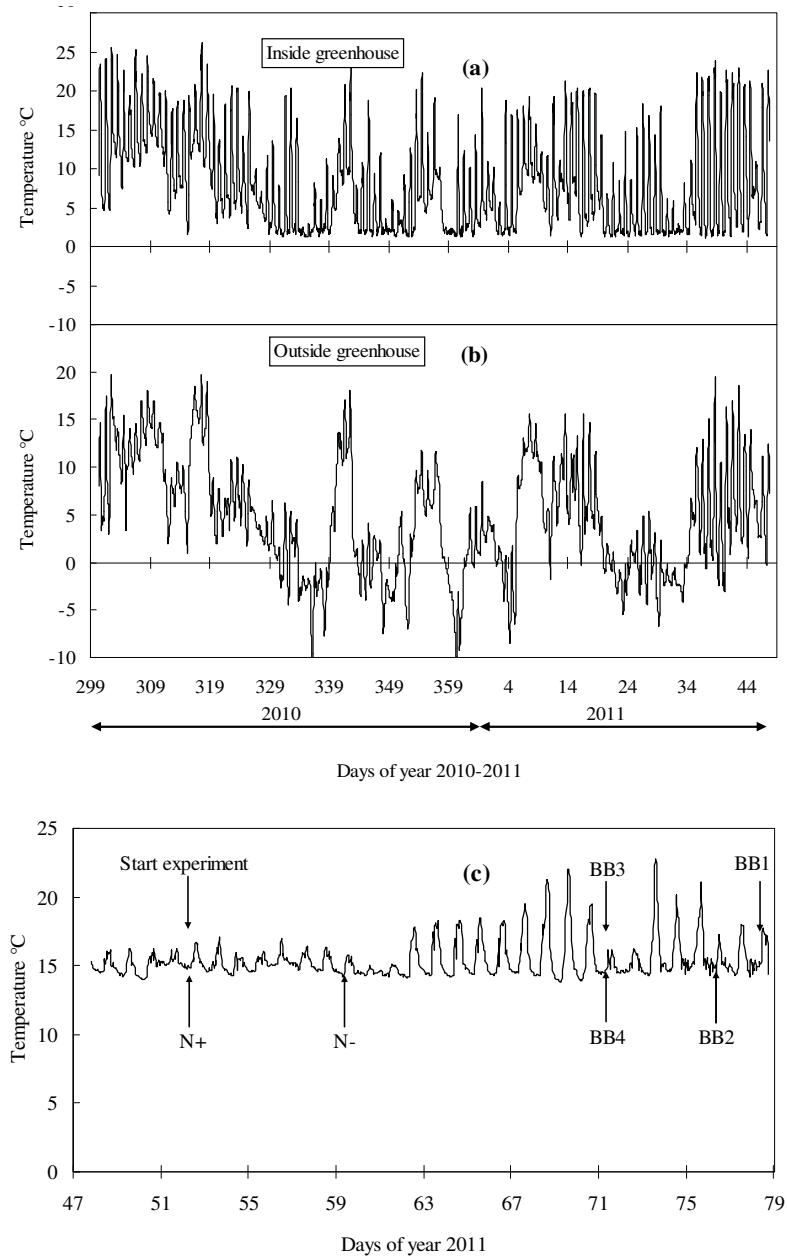

Fig. 3.32 : Temperature of pre-treatment period on 3 November 2010 (307 days of year 2010) until 15 February 2011(46 days of year 2011), plants were prepared by source into two groups. Both groups of plants were grown under different temperature during autumn and winter. Temperature inside greenhouse (a), temperature outside greenhouse (b), and temperature of greenhouse conditions during experiment period (c). The arrows represent the time of start experiment during nitrate supply to *N-Pulse*, and *N-Pulse/-out* treatments (N+) on 21 February 2011 (52 days of year 2011), first time change solution without nitrate to *N-Pulse* and *N-Pulse/-out* treatments (-N), respectively, and first bud break period of *Control* (BB1), *N-Pulse* (BB2), *Control/-out* (BB3), and *N-Pulse/-out* (BB4) treatments, respectively.

3.3.3.2 Environment Control

The experimental pre-treatments were prepared by sourcing plants into two groups on 3 November 2010 (307 days of year 2010) until 15 February 2011 (46 days of year 2011). The first group of plants was remaining inside greenhouse. The second group was moved and placed outside greenhouse. Temperature pre-treatment period showed that temperature inside greenhouse was average 7.7°C (Fig. 3.32a) while temperature outside greenhouse was low, about 4.4°C (Fig. 3.32b). During experiment, both groups were moved and placed in the same greenhouse. This experiment undertook in a greenhouse with natural light and controlled temperature. The temperature in the greenhouse was reset as spring temperature about 15.4°C (Fig. 3.32c).

3.3.3.3 Nitrogen Uptake

The dynamic curves of nitrogen uptake showed that poplars can uptake nitrogen before bud break (Fig. 3.33). The results of *N-Pulse* and *N-Pulse/-out* showed that nitrogen was dramatically taken up when poplars were supplied with nitrogen. However, the schedule of curves was changed when plants were supplied solution without nitrate on the day 59. From that day, plants did not uptake any nitrogen until the end of experiment. Total nitrogen uptake of *N-Pulse* and *N-Pulse/-out* at the end of experiment was 0.63 and 0.61 g.plant⁻¹, respectively. However, according to the curve of nitrogen uptake for plants grown in the without nitrate solution, it revealed that nitrogen uptake was 0 g.plant⁻¹. The curve was stable throughout the experiment period.

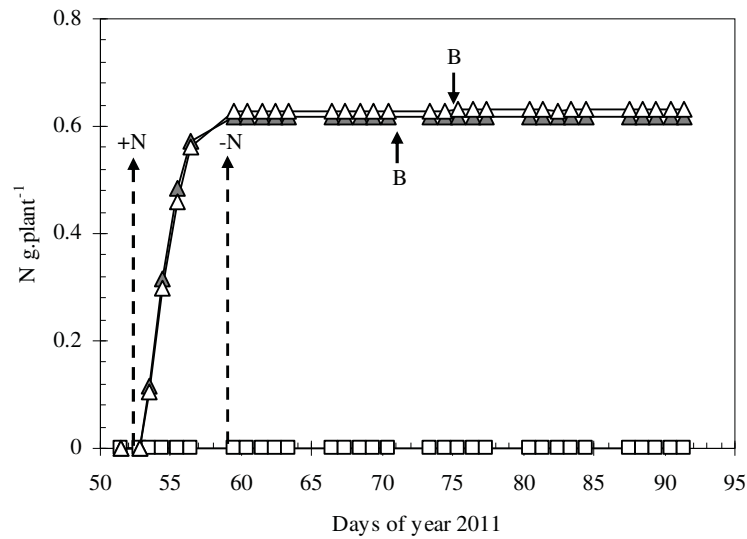

Fig. 3.33 : Cumulated nitrogen uptake (g.plant^{-1}) during experiment period 2011, *Control* and *Control/-out* (\square), *N-Pulse* (Δ), and *N-Pulse/-out* (\blacktriangle). The arrow represents experiment start supplying nitrate to *N-Pulse* and *N-Pulse/-out* treatments (N+). On day 59 solution was changed to a solution without nitrate for *N-Pulse* and *N-Pulse/-out* treatments (-N), respectively. The first time of bud break in *N-Pulse* and *N-Pulse/-out* treatments (B).

3.3.3.4 Water Content

Water content in main stem after bud break showed that nitrogen and temperature affected water content in bark and xylem. However, the interaction between nitrogen and temperature factors did not significantly affect water content in bark and xylem (Table 3.12).

The influence of nitrogen factors on water content in bark and xylem showed that water content in plants grown with nitrate supply before bud break was higher than plants grown without nitrate supply. The water contents in plants grown in solutions without and with nitrate were 1.18 and 1.23 g.g^{-1} in bark, and 1.24 and 1.44 g.g^{-1} in xylem, respectively.

In addition, influence of temperature factor on water content showed that water content in xylem of poplars grown outside greenhouse during winter was higher than in plants grown inside greenhouse, 1.39 and 1.28 g.g^{-1} , respectively. In contrast, water content in bark from plants grown outside greenhouse during winter was lower than in plants grown inside greenhouse, 1.17 and 1.24 g.g^{-1} , respectively.

Table 3.12 : Water content in bark and xylem of main stem after bud break during the experiment period 2011.

Nitrogen ¹	Factors Temperature ²	Water content (g.g ⁻¹)	
		Bark	Xylem
<i>Control</i>	In	1.21 ± 0.04	1.16 ± 0.12
<i>Control</i>	Out	1.15 ± 0.05	1.31 ± 0.02
<i>N-Pulse</i>	In	1.29 ± 0.06	1.41 ± 0.07
<i>N-Pulse</i>	Out	1.20 ± 0.01	1.47 ± 0.06
Nitrogen		*	**
Temperature		*	*
Nitrogen*Temperature		ns	ns

Data are means ± SD of three plants per treatment

ns non significance

* significant (0.05)

**significant (0.01)

¹Nitrogen factor, supply solution without nitrate throughout the experiment period (N-) and supply solution with nitrate was applied for seven days. Then, after that the second solution without nitrate was applied throughout the experiment period.

² Temperature factor, this factor was produced by separate plants into two groups before start the experiment during winter. The first group was remaining planted inside greenhouse (In). The second group was moved and placed outside greenhouse (Out).

3.3.3.5 Timing of Bud Break and New Shoot

Timing of bud break shows that interaction between nitrogen and temperature factor affected the timing of first bud break ($P < 0.05$). Bud break occurred earlier outside (day 71-72) than inside the greenhouse (day 75-79). Outside the greenhouse, N treatment had no effect, whereas inside the greenhouse *N-Pulse* produced the first bud break 2 days before *Control*. Results were similar for the timing of 50% bud break (Table 3.13).

The numbers of bud break per branch showed that temperature factor during winter has significant ($P < 0.05$) effect on the numbers of bud break (new shoots). This experiment found that at the end of experiment, poplars placed outside greenhouse during winter have a greater numbers of new shoots than plants placed inside greenhouse, by 0.06 fold.

Comparing dry weight of new shoots at the end experiment showed that temperature factor during winter has significant ($P<0.05$) effect on the dry weight of new shoots. This experiment found that at the end of experiment, and concerning poplars placed outside greenhouse during winter, the dry weight of new shoots was higher than plants placed inside greenhouse, by 0.26 fold. However, nitrogen factor has no affect. The trend of dry weight was low in *Control* treatment.

Table 3.13 : Date of bud break, number of new shoot, and dry weight of new shoot

Factors		Date of bud brake ³		New shoot	
Nitrogen ¹	Temperature ²	T ₀	T ₅₀	Number	Dry weight (g)
<i>Control</i>	in	78.2 ± 2.6 a	80.9 ± 2.1 a	24.9 ± 2.0	5.7 ± 2.6
<i>Control</i>	out	71.1 ± 1.0 c	73.3 ± 0.4 c	23.7 ± 1.9	8.5 ± 1.9
<i>N-Pulse</i>	in	76.0 ± 1.3 b	77.9 ± 1.8 b	24.9 ± 1.5	7.9 ± 3.1
<i>N-Pulse</i>	out	72.0 ± 1.5 c	73.9 ± 1.1 c	23.3 ± 1.5	8.6 ± 2.7
Nitrogen		ns	*	ns	ns
Temperature		**	**	*	*
Nitrogen*Temperature		*	**	ns	ns

Data are means ± SD of 9 branches per treatment

^{ns} non significance

* significant (0.05)

**significant (0.01)

¹Nitrogen factor : supply solution without nitrate throughout the experiment period (N-) and supply solution with nitrate was applied for seven days. Then, after that the second solution without nitrate was applied throughout the experiment period.

²Temperature factor : this factor was produced by separate plants into two groups before start the experiment during winter. The first group remained planted inside greenhouse (In). The second group was moved and placed outside the greenhouse.

³Date of bud break : first bud break (T₀), and 50 percent of total bud break (T₅₀) (date of year 2011)

3.3.3.6 Nitrogen of New Shoot

Analysis nitrogen content in new shoot at the end of experiment showed that nitrogen ($P<0.01$) and temperature factors ($P<0.01$) have significant effect on nitrogen content in new shoots (Table 3.14). The result showed that the nitrogen content in poplars supplied with nitrate before bud break was higher than that in poplars not supplied with nitrate, by 0.08 fold. The finding of temperature factor showed that, when poplars were placed inside greenhouse

during winter, nitrogen content in new shoots was higher than when poplars were placed outside greenhouse, by 0.11 fold. Low nitrogen content in new shoots from poplars placed outside greenhouse during winter occurred because of the early produced bud break and the increase of dry weight of new shoots (Table 3.13). Therefore, calculated nitrogen content of the outside greenhouse plants was disturbed by increasing dry weight. The result is similar to the Experiment II which found that stump poplars that were supplied with nitrogen before bud break produced earlier bud break, increased dry weight of new shoots, and decreased nitrogen content in new shoots than other groups that were not supplied with nitrogen before bud break. In addition, Experiment III found that temperature factor had no significant effect on the total nitrogen in new shoots. However, the trend of total nitrogen in new shoots was higher for poplars placed outside greenhouse during winter. The experiment also found that nitrogen supply before bud break impacted on plants by increasing total nitrogen content in new shoots, by 0.3 fold (Table 3.14).

Table 3.14 : Nitrogen content and total nitrogen of new shoot at the end of experiment 2011

Factors		Nitrogen content	Total nitrogen
Nitrogen ¹	Temperature ²	(mg.g ⁻¹ DW)	(mg)
<i>Control</i>	in	26.7 ± 3.6	145.0 ± 56.8
<i>Control</i>	out	23.2 ± 0.8	198.2 ± 49.7
<i>N-Pulse</i>	in	27.8 ± 1.2	218.7 ± 81.4
<i>N-Pulse</i>	out	26.1 ± 0.9	223.8 ± 69.9
Nitrogen		**	*
Temperature		**	ns
Nitrogen*Temperature		ns	ns

Data are means ± SD of 9 branches per treatment

^{ns} non significance

* significant (0.05)

**significant (0.01)

¹Nitrogen factor : supply solution without nitrate throughout the experiment period (N-) and solution with nitrate was supplied for seven days. Then, after that the second solution without nitrate was supplied throughout the experiment period.

² Temperature factor : this factor was produced by separate plants into two groups before start the experiment during winter. The first group was remaining planted inside greenhouse (In). The second group (Out) was moved to place outside greenhouse.

3.3.3.7 Mineral Uptake

Four minerals were assessed for this experiment: potassium, phosphorus, calcium, and magnesium. The dynamic curves of mineral uptake in *Control* and *Control/-out* treatments were similar as such treatments were grown by placing them together within the same solution recirculation system. However, nutrient solution content was calculated for net mineral uptake. The net mineral uptake was formulated as the difference between initial and final ion content of nutrient in the solution. Nutrient uptake of *Control* and *Control/-out* could not be separated, therefore, calculated mineral uptake of such treatments was equally averaged. However, for other treatments (*N-Pulse* and *N-Pulse/-out*), they were separately placed in the solution recirculation system. Therefore, their mineral uptake was calculated separately.

Dynamic curves of potassium uptake showed that poplars could uptake potassium before and after bud break until the end experiment (Fig. 3.34a). Two treatments, *Control* and *N-Pulse/-out* treatments, slightly took up potassium before bud break. While *N-Pulse* treatment up took for 2 day when they had nitrogen supply, and then potassium was flowed out later. *N-Pulse* treatment slightly took up potassium again when supplied with solution containing no nitrogen. The dynamic curves of potassium uptake of *Control*, *N-Pulse*, and *N-Pulse/-out* dramatically increased after bud break. Total potassium uptake at the end of experiment of such three treatments was 0.57, 0.27, and 0.52 g.plant⁻¹, respectively.

Dynamic curves of phosphorus uptake showed that poplars could uptake phosphorus before and after bud break until the end experiment (Fig. 3.34b). *N-Pulse/-out* phosphorus uptake was higher than *N-Pulse* and *Control*, respectively. Total phosphorus uptake at the end of experiment in *Control*, *N-Pulse*, and *N-Pulse/-out* treatments was 0.14, 0.21 and 0.25 g.plant⁻¹, respectively.

Calcium and magnesium uptake of all treatments were flowed out, especially for *N-Pulse* and *N-Pulse/-out* treatments before bud break. After that, the dynamic curves of calcium and magnesium after bud break were constant until the end of experiment. The total calcium efflux at the end of experiment in *Control*, *N-Pulse* and *N-Pulse/-out* treatments was 0.25, 0.43 and 0.40 g.plant⁻¹ (Fig. 3.34c), and magnesium efflux was 0.02, 0.10 and 0.09 g.plant⁻¹, respectively (Fig. 3.33d).

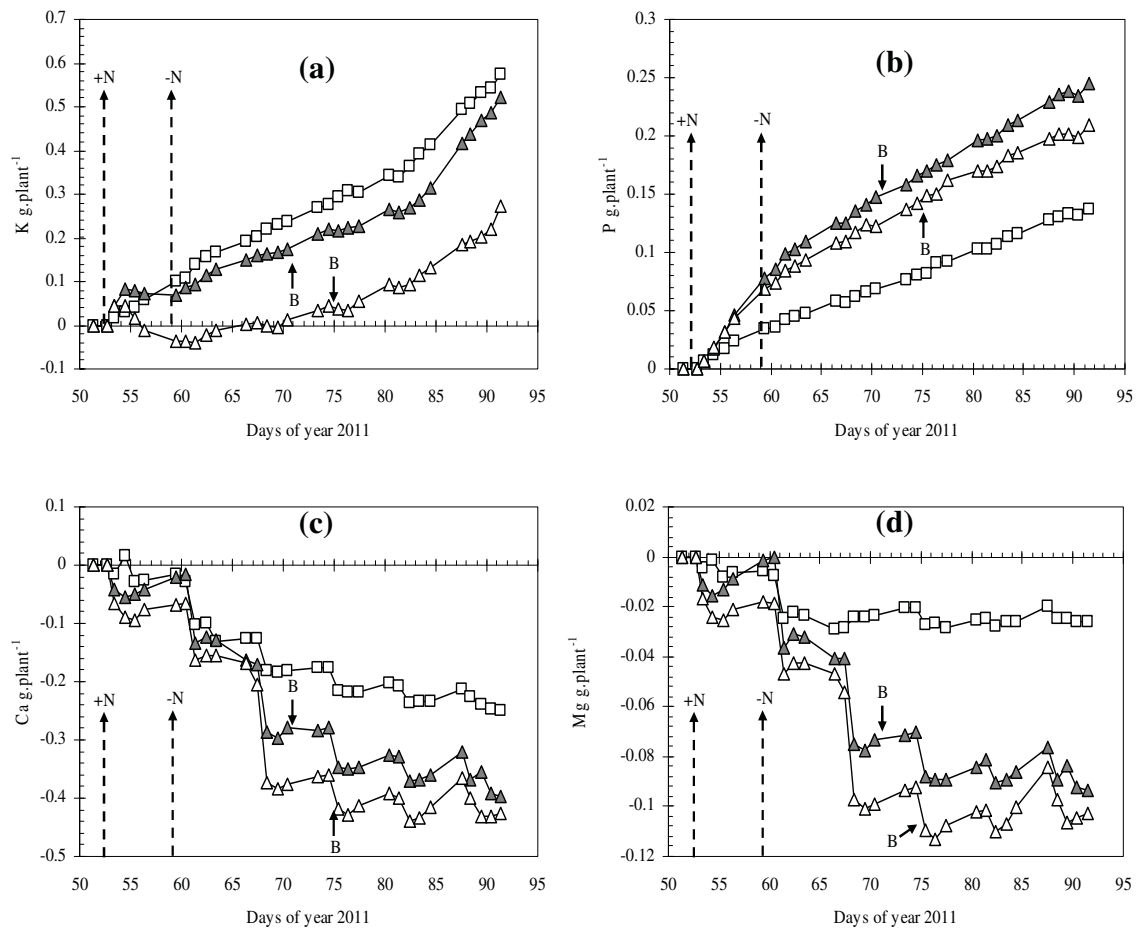

Fig. 3.34 : Cumulate potassium (a), phosphorus (b), calcium (c), and magnesium (d) uptake (g.plant^{-1}) during experiment period 2011, in Control and Control/out (\square), N-Pulse (\triangle), and N-Pulse/out (\blacktriangle) conditions. The arrows represent experiment started during supplying nitrate to N-Pulse and N-Pulse/out treatments (N+). On day 59 solution was changed to the solution without nitrate in N-Pulse and N-Pulse/out treatments (-N), respectively. First time of bud break for N-Pulse and N-Pulse/out treatments (B).

3.3.4 Discussion

This experiment purposes to investigate the effect of nitrogen on new shoot growth of poplars planted in different temperature conditions during dormancy. The results of the experiment confirm previous experiments (Experiment I and Experiment II) which found that poplars can uptake nitrogen before bud break. According to the dynamic curves (Fig. 3.33), poplars take up nitrogen before bud break, when grown inside or outside greenhouse during winter. Therefore, differences in winter temperature do not exert a marked effect on nitrogen uptake. Such result is consistent with previous studies on young maple trees (Delaire, 2005) and one-year apple (Dong et al., 2001). Those plants nitrogen uptake before bud break, depend on temperature and nitrogen availability around root during spring, before bud break. In addition, both previous experiments of this study (Experiment I and Experiment II) accept that poplars uptake N before bud break induced positive xylem pressure and it is consistent with the study of Ewer *et al.* (2001). Ewer *et al.* (2001)'s study found that walnuts can uptake nitrate when soil temperature was high. They also proposed that positive xylem pressure is one of the mechanisms responsible for the refilling of water in xylem during spring re-growth (Ameglio *et al.*, 2002; Ameglio *et al.*, 2001). Such positive root pressure increased water content (Table 3.12). Accordingly, this study concludes that, as in other plants, water content early bud break in compartment tissues related to positive xylem pressure before bud break, as a mechanism of water refilled in xylem sap before bud break of poplars, occurred when plants uptake N before bud break.

A number of previous studies indicate that low winter temperature (chilling) is the most important environmental factor regulating the timing of bud break in temperate trees (Heide, 2003; Linkosalo *et al.*, 2006; Myking and Heide, 1995). Likewise, the findings of this experiment confirm previous studies according to which low winter temperature has larger impact on timing of bud break in poplars, over the nitrogen factor. Poplars transplanted outside greenhouse (*Control-out* and *N-Pulse-out*) during winter was submitted to lower air temperature than plants transplanted inside greenhouse (*Control* and *N-Pulse*). *Control-out* and *N-Pulse-out* induced the timing of first bud break and 50 percent of total bud breaks before *Control* and *N-Pulse* for about one week. Timing of bud break also was influenced by nitrogen factor when poplars were planted inside greenhouse during winter. *N-Pulse* induced the timing of bud break earlier than *Control* by 2-3 days. Such findings may be interpreted as fully dormancy released by low temperature. Therefore, N treatment had no effect, while date of bud break depended on temperature only. Consistent with the findings of Myking and Heide (1995) in *Betula pendula* Roth and *Betula pubescens*, long photoperiods ($112 \pm 5 \mu\text{mol.m}^{-2} \text{s}^{-1}$ PAR) significantly reduced the chilling time required for bud burst after short chilling periods

(44 and 74 days, respectively), but had no effect when the chilling requirement was fully met after 105 chilling days.

Supplied nitrogen before bud break less affected plants bud break. However, the nitrogen supply before bud break has significantly effect on the new shoots development after bud break. Such result confirms the findings in Experiments I and II, where nitrogen supply before bud break increases nitrogen content and dry weight of new shoots.

Temperature-based models are commonly used to predict bud break of deciduous trees (Bailey and Harrington, 2006; Hdied, 2003 Rahemi and Pakkish, 2009). This experiment explain the different timing of bud break for plant placed inside and outside the greenhouse by the temperature-based models, the chilling and heat hours requirement models. However, the effectiveness of time-temperature combinations on meeting chilling requirements varies between tree species. Each tree species has specific chilling requirements, related either to the accumulated hours below a chilling temperature threshold or to cumulative chill unit, which are hours that are weighted for temperature effectiveness at breaking dormancy. However, data (chilling requirements,) to predict bud break in poplars (*Populus tremula* × *opulus alba*, clone INRA 717-1B4) did not complete such as the data for measure the chilling hours and number hours with threshold temperature. Thus, this experiment calculated the cumulative chill unit by assume the threshold temperature according to Cesaraccio *et al.* (2004). Cesaraccio *et al.* (2004) reported that the threshold temperature of *Populus tremula* is 10.1 °C. Thus, the threshold temperature was selected in the calculation of Positive Chill Unit (PCU) model (Linsley-Noakes *et al.*, 1995).

Assuming that if the temperature is equal or higher than 10.1 °C, then the chill unit is 0 unit. If the temperature is lower than 10.1°C, then the chill unit is 1 unit. Therefore, the accumulated chill unit was equal to zero until the temperature dropped to meet the effective zone and the positive chill unit started to accumulate on 13 October 2010 (286 days of year 2010). From the accumulated chill unit graph of this experiment (Fig. 3.35), the possible highest accumulated chill unit for both plant groups placed inside and outside greenhouse during winter, is 2073 unit before experiment start (15 February 2011). If the full accumulated chilling requirement of poplar is higher than 2073, then the plants placed inside greenhouse during winter will not produce full accumulated chilling requirement. Because of, the temperature during experiment period was controlled as spring temperature about 15.4°C (Fig. 3.32c) which was higher than that threshold temperature, the temperature cannot be calculated to meet the full accumulated chilling requirement. However, this experiment found that both groups of plants produced bud break in spring (Table 3.13). Therefore, the possible

accumulated chill unit should not be higher than 2073 unit. Figure 3.34 presents that for plants placed outside greenhouse. Their dormancy was broke (2073 unit) before plants placed inside greenhouse about 13 days. Then, the heat requirement started to calculate until bud break. The heat requirement, calculated by Growing Degree Hours (GDH), revealed that the accumulated temperature above the based temperature was 4.5°C. The growing degree hours were recorded according to the studies of Kuden *et al.* (1995) and Richardson *et al.* (1975).

For calculating heat requirement, this experiment assumes that the 800 GDH is full heat requirement of 50 percent bud break of poplars (*Populus tremula* × *opulus alba*, clone INRA 717-1B4). Because at 800 GDH the 50 percent bud break of both plants placed inside and outside greenhouse during winter was 22 Mar (81st day of year 2010) and 14 Mar (73rd day of year 2010), respectively ; similar to the results observed on *Control* and *Control/-out* (Table 3.13).

However, it should be noted that the chilling and heat hours requirement models of poplars (*Populus tremula* × *opulus alba*, clone INRA 717-1B4), for this experiment, were calculated based on the possible assumption of threshold temperature of *Populus tremula* is 10.1 °C and GDH temperature is 4.5°C. Further research should extend more data of threshold temperature, number of chill unit, and specific temperature for calculating growing degree hours.

In summary, poplars grown inside and outside greenhouse in winter can uptake nitrogen before bud break. Low temperature during winter has larger impact on the timing of bud break in poplars, over the nitrogen factor. However, nitrogen uptake in poplars before bud break has a significant effect on the new shoots quality after bud break.

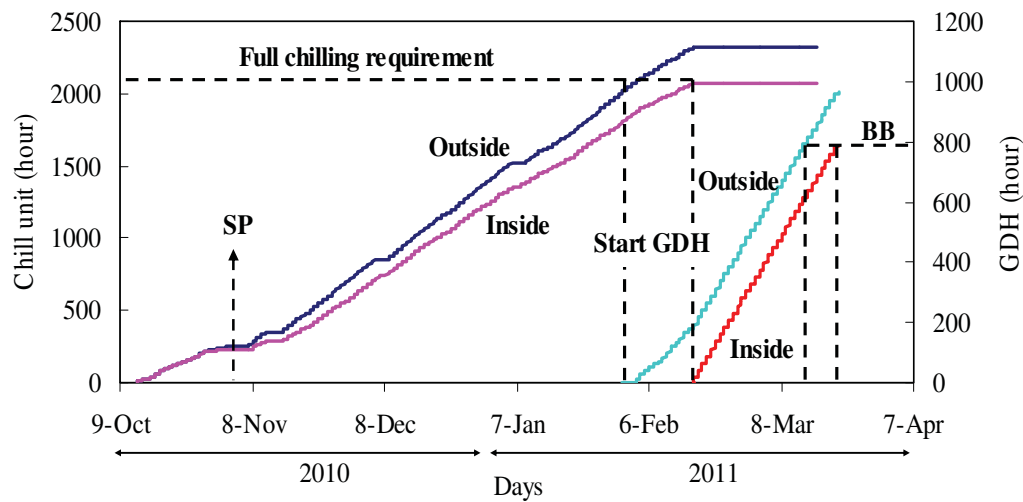

Fig. 3.35 : Chill unit accumulation curves of Positive Chill Unit model (PCU). Threshold temperature of PCU is 10.1 °C, the effective zone. The accumulated chill unit is equal to zero until the temperature drop to the effective zone and positive chill units begin to accumulate on 13 October 2010. This experiment assumes that full chilling requirement is 2073 unit. Then, growing degree hours (GDH) accumulation starts above the base temperature of 4.5°C. The GDH of 50 % bud break of *Control* and *Control-out* is about 800 GDH hours. SP represents plants separated into two groups: inside and outside greenhouse. BB assumes as the GDH of bud break, about 800 GDH.

Chapter 4: General Discussion

4.1 Nitrogen Uptake

The findings of experiments I, II, and II confirm the first hypothesis that poplars can uptake N before bud break. However, applying the nutrient solution with nitrate throughout the experimental period, show that plants could uptake N dramatically only within 10 days after supply solution, and then the N uptake decreases. Nitrogen was re-uptake again after bud break, when leaf area of new shoots increases. Therefore, N uptake may be controlled and/or affected by some processes of poplars growth and development (Fig. 4.1).

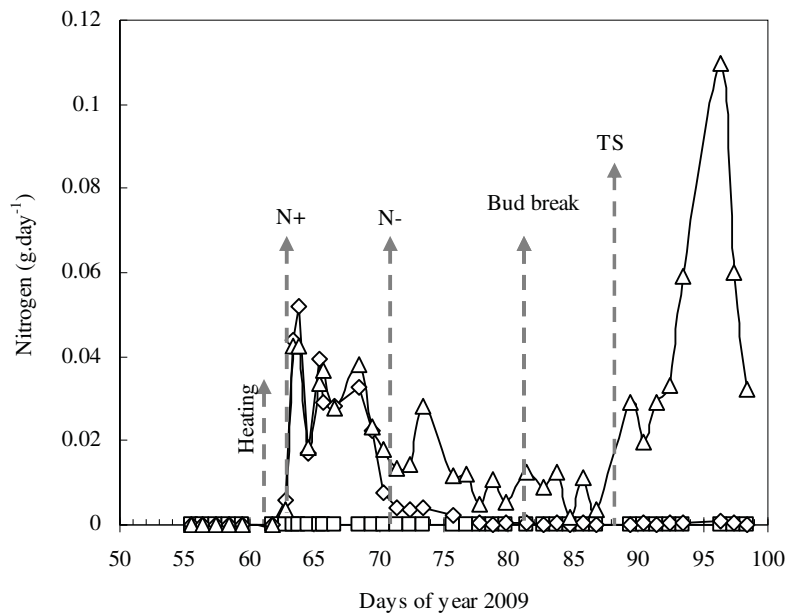

Fig. 4.1 : Nitrogen uptake ($\text{g}\cdot\text{day}^{-1}$) during experiment I period 2009 of *Control* (\square), *N-Pulse* (\diamond), and *N-Supply* (Δ) treatments. The arrows represent the time of increase temperature in greenhouse, start experiment during supply solution with nitrate to *N-Pulse* and *N-supply* treatment (N+), first time change solution without nitrate to *N-Pulse* treatment (-N), bud break period (Bud break), and start transpiration (TS), respectively.

According to the regulating process of N uptake by roots, it was not fully clarified by experiments I, II, and III. However, several studies found that external and internal conditions regulate the N uptake process by roots. Such external conditions could link available N and temperature in root zone (Dong *et al.*, 2001; Ter Steege *et al.*, 1999; van den Driessche *et al.*, 2008; Yin *et al.*, 2009). For example, Dong *et al.* (2001) reported that apple trees could not

uptake N before bud break when plants were grown in soil at 8°C, whereas N uptake increased with the increasing of soil temperature to a range of 12°C to 20°C. In experiments I, II, and III, temperature in greenhouse and substrate were set at 15-20°C. Therefore, temperature factor may play a role on the uptake N of poplars before bud break.

Concerning internal conditions, a number of studies evidence that when N, as nitrate, is up taken by roots, a part of nitrate uptake is transformed to NH₄ or amino acid. Generally, these N compounds are mobilized to various parts of plant via xylem (Dong *et al.*, 2001; Frak *et al.*, 2002; Guérin *et al.*, 2007; Millard *et al.*, 2006; Salaün *et al.*, 2005). However, all experiments of this study found that N was up taken before bud break, when plants have no leaf. While sap in xylem did not mobilize, or there was relatively low mobilized sap with root pressure when plants uptake N before bud break, thus uptake N before bud break was stored in roots. Accordingly, N uptake decreased because of N compounds accumulation in roots. To support the findings that N storage regulates nitrate uptake, King *et al.* (1993) suggested that nitrate influx inhibition in barley (*Hordeum vulgare*) is potentially mediated through several N pools, including that of nitrate itself. The inhibitory effect of amino acids in root tissues on nitrate uptake was confirmed in recent studies of Gessler *et al.* (2004) and Dłuzniewska *et al.* (2006). Therefore, N compounds accumulation in root feedback regulation can reduce nitrate uptake.

The results recorded after bud break of *N-Supply* experiments showed that the role of feedback regulation of nitrate uptake was decreased, when leaf area growth was recovered and transpiration increased, then N accumulated in root was transported by xylem sap to compartment tissues, and poplars also re-uptake nitrate dramatically again. Consistent with the findings of previous studies (i.e. Dłuzniewska *et al.*, 2006; Gessler *et al.*, 2004; Grassi *et al.*, 2003; Malaguti *et al.*, 2001; Miller *et al.*, 2008), suggests that recycling of N in the xylem is a mechanism by which plants regulate N uptake by root. Touraine *et al.* (1992) support that N uptake in soybean increased when NO₃⁻ translocation to shoots increased. However, nitrate uptake decreased when nitrate reductase activity in shoots was inhibited by tungstate. Accordingly, net NO₃⁻ uptake was regulated by the whole plant demand and concentration of N metabolites, including NO₃⁻, in tissues (Vidmar *et al.*, 2000).

4.2 Nitrogen Uptake before Bud Breaks Influence on Nitrogen and Non Structural Carbon Reserve

Nitrogen Reserve

The stored N during previous year in compartment tissues can be remobilized to support re-growth. The experiment results support previous studies where deciduous trees increase stem and root N concentration in autumn while such N concentrations decrease in spring due to the increase of N content in new shoot (Dyckmans and Flessa, 2001; Frak *et al.*, 2002; Marmann *et al.*, 1997). New shoots growth in spring is the strongest sink for N remobilization. Nitrogen mobilized from storage tissues to sustain spring growth was reported to account for 93% of total leaf N found in *Prunus persica* L. after 4 weeks of growth (Muñoz *et al.* 1993), about 60% in *Betula pendula* Roth. (Wendler and Millard 1996) and *Acer pseudoplatanus* L. (Millard and Proe 1991) and 54% in walnut (*Juglans nigra* × *J. regia*) (Frak *et al.*, 2002). In poplars grown without N during bud break, nitrogen support new shoot only come from nitrogen storage tissue remobilization. For example, stored nitrogen in the one-year scion poplar, remobilizes to support new shoots, 15 days after bud break for 45% of total stored N was mobilized for new shoot growth. (Fig. 3.10). Stored N from stem bark and big root are the main sources remobilized to support new shoot development 52% and 30% of the total N of new shoot, respectively (Table 3.4).

Poplars supplied with nitrogen before bud break have greater N content in compartment tissues after bud break than plants grown without N, especially in roots and new shoots. However, such result is ambiguous whether the increase of N content in the new shoots after bud break comes from N uptake or/and remobilization of previously stored. This is because, according to Experiments I, II, and III, N uptake and N remobilization to new shoots could not be separated. Number of previous studies showed that N uptake by their roots begins concomitantly to N remobilization. These include deciduous *Juglans nigra* × *J. regia* (Frak *et al.*, 2002), *Betula pendula* (Malaguti *et al.*, 2001) and evergreen *Pinus sylvestris* (Malaguti *et al.*, 2001). In contrast, the studies undertook on other plant species have shown that stored N mobilization supporting new shoots growth in spring occurred before the utilization of uptaken N by root. Such utilization was found in some deciduous species such as *Malus domestica* (Guak *et al.*, 2003; Malaguti *et al.*, 2001), *Prunus avium* (Grassi *et al.*, 2003; Millard *et al.*, 2006) and *Pyrus communis* (Tagliavini *et al.*, 1997). In addition, a study of Millard *et al.* (2006) was undertaken in the 10 years-old poplar supplied with ¹⁵N (*Populus trichocarpa* Torr. & Gray ex Hook var. *Hastata* (Dode) A. Henry x *Populus balsamifera* L. var. *Michauxii*

(Dode)) at bud break. Their study showed that the ^{15}N supply at bud break was not recovered in leaves until 36 days after bud break.

Sources of N in this study are different than that of previous studies. The study focuses on nitrogen uptake on poplar before bud break, with the assumption that the new uptake N, accumulated in roots, was used in the same way as the previously stored N. Both accumulated N and previously stored N in root are exported to xylem and then transported to other tissues, within sap leak before bud break and water transpiration after bud break (Frak *et al.*, 2002; Glass *et al.*, 2002). This assumption is confirmed by the results of Experiments I, II and III. N reserve of above-ground early bud break was increased when poplars up took N before bud break.

In addition, the results of the one-year scion poplar showed that the total N mobilization (N net flow) for *N-Pulse* and *N-Supply* conditions, from stems and roots to new shoots, was not recovered as the total N content in new shoots 15 days after bud break. The total N mobilization for *N-Pulse* and *N-Supply* was 53% and 6% of the total nitrogen content in new shoots, respectively (Table 3.4). But N content of new shoot and compartment tissues for *N-Pulse* and *N-Supply* was higher than that of *Control*. Therefore, the increase of N reserve in compartment tissues 15 days after bud break supports the finding that nitrogen uptake before and during bud break mobilized from roots to the other parts of plant. Generally, N uptake and N remobilized from different tissues is transported in the sap flow throughout the plant. The transport N forms, mostly are amino acids such as asparagine and glutamine in poplar (Couturier *et al.* 2010), could be exchanged, captured from the xylem sap to supply protein synthesis in living cells or released from tissues to the xylem sap. These exchanges could be driven by the affinity of the tissues for N, which may induce autocatalytic processes for the release of N reserves, and perhaps C reserves, along the xylem sap stream. According to this hypothesis, the appearance of a low N contribution of the scion to the re-growth of plants supplied with nitrate could be explained by a differed reload of compartments tissues in relation with the xylem sap content.

Nitrogen Uptake Mobilization

The mobilization of uptake N from below-ground to above-ground found that nitrogen uptake is mobilized, via xylem sap transportation (Frak *et al.*, 2002; Glass *et al.*, 2002). In experiments I, II, and III, the mobilization of N uptake was separated into two periods: before bud break by root pressure when poplars uptake N, and after bud break by transpiration, when leaves are functional.

The xylem sap before bud break was mobilized by root pressure. Positive root pressure is correlated to nitrate uptake in poplars, before bud break. Positive root pressure and xylem pressure are associated to solutes accumulation (Ameglio *et al.*, 2002; Ameglio *et al.*, 2001a; Clearwater *et al.*, 2007; Ewers *et al.*, 2001). Presumably, the positive root pressure measured in this study is related to the nitrate supply before bud break, possible link on N accumulated activity in roots (Ewers *et al.*, 2001). Root and xylem sap pressures during early spring, before bud break, is one of the mechanisms responsible for the refilling of water in xylem during spring re-growth (Ameglio *et al.*, 2002; Ameglio *et al.*, 2001b). Root pressure could provide a force by pushing water and some biochemical substances (e.g. carbon and nitrogen compounds) in root transport up to the stems. However, the results of this study showed that such force is not enough to mobilize nitrogen uptake from the roots to the top of tree before bud break. The mobilization could happen, depending on the strength of root pressure, available space in xylem, and sap leak. For example, in the one-year scion poplar, the mobilization capacity of xylem sap, from roots to above-ground, depends on root pressure and available space in xylem of above-ground. Above-ground part of the one-year scion poplar functions like a closed tube. When pushing water into the tube, water moves to fill up spaces inside the tube. Therefore, water is unable to move when spaces are all replaced by water. However, when tube leaks, it will allow water to move again. In Experiment II, nitrogen uptake before bud break in stump poplars induces root pressure and resulted to sap leak at the cutting area (Fig. 3.27). The sap leak so induced sap flow before bud break. Therefore, it is possible that uptake N before bud break could be mobilized. However, the main part of N uptake before bud break, in one-year scion and stump poplar, is still stored in roots before bud break.

Moreover, xylem sap and N performed high mobilization when plants produce thriest leaf after bud break, particularly during transpiration increase (Frak *et al.*, 2002; Glass *et al.*, 2002). To confirm such studies, this study found that N uptake in plants increased in relation to transpiration enhancement. The finding suggests that transpiration and sap mobilization induce the N uptake mobilization, from roots to the other parts of plant. Then, the feedback regulation of N uptake decreased and plants can re-uptake N again (Fig. 4.1).

Carbon Reserve

Stored carbon is used to support respiration and re-growth, during spring until the early re-growth period, when carbon assimilation is recovered in new shoots. In poplar (*Populus tremula* × *Populus alba*, clone INRA 717-1B4), starch was the main non structural carbon (NSC) reserve. Below-ground exhibited major stored NSC tissue. These results are consistent with those studies performed on some deciduous trees such as *Pinus taeda*, and *Populus*

tremuloides (Landhäusser and Lieffers, 2002; Landhäusser and Lieffers, 2003; Ludovici *et al.*, 2002). This study found that the total NSC content in below-ground decreased at the breaking and time of flush toward. The decrease of the total NSC content in below-ground and the increase of NSC in above-ground shortly after bud break can explained the NSC remobilization from below-ground to above-ground to support re-growth. This statement is confirmed by the results of Experiment II showing that the mobilized NSC from below-ground to above-ground is excessive to support re-growth (Fig. 3.25). Therefore, the excessive NSC mobilization accumulated in stems and branches, as starch. The accumulated starch could then be converted into sugars to support future shoot growth.

Poplars' N uptake during the experiment period (*N-Pulse* and *N-Supply*) changed the NSC used in each compartment tissue. This is because the NSC utilization, under *N-Pulse* and *N-Supply* conditions, was greater than under *Control* one. In *N-Pulse* and *N-Supply* treatments, NSC was used for some activities as plants invest more energy in roots for nutrient capture, such as nitrogen uptake and N assimilation (Bloom *et al.*, 1992; de Visser *et al.*, 1986; Sasakawa and Larue, 1986). NSC could also be used to establish root pressure (Ameglio *et al.*, 2001). While stem and branch of poplar uptake N during experiment period, the enhancement of NSC used to support new shoots development induced early bud break, the increased leaf area and biomass of new shoots. It is possible that stem and branch tissues used NSC for reload N during early bud break. This statement is confirmed by the results showing that N reserve in stem and branch tissues was increased early bud break (Fig. 3.9 and Fig. 3.25)

In addition, the result of the one-year scion poplar showed that when plants were supplied nitrogen before bud break, the total NSC used was not recovered as carbon used to produce new shoots (dry weight of new shoots) early bud break (Table 3.6). This result confirms the hypothesis that nitrogen uptake in poplars before bud break increases the nitrogen concentration of new shoot early after bud break. This nitrogen uptake also relates to the increase carbon assimilation through the raise of photosynthesis activity. The result is consistent with previous studies which found the increase of the level of supplied nitrogen availability to poplars is positively correlated with nitrogen concentration in leaves, chlorophyll concentration, leaf area, and the photosynthetic parameters (Cooke *et al.*, 2005; Ripullone *et al.*, 2003).

4.3 Nitrogen Uptake before Bud Breaks Influences the development of Re-growth early Bud Break

Bud Break

Bud break is the visible event indicating the end of winter dormancy and start of re-growth. Uptake N before bud break influences bud breaking in poplars differently in the Experiments I, II, and III. For the experiment I, there is no significant influence of N uptake in the one-year scion poplars before bud break. However, when experiments were made using stump poplars (the experiment II), N uptake played a role on bud break. Plants being supplied with N before bud break produced new shoots earlier than non supplied plants. The different effect of uptake N on poplars, noted from both experiments, may occur because of the shape of stem and bud structure. Buds of one-year scion poplars, according to experiment I, were produced between top and medium-main stems, where bud scales stipule and small leaf lamina developed since the experiment started (Fig. 3.14).

In relation to Experiment II, the buds of stump poplar were produced at the base-branches. The buds were small and some could not be seen before the experiment start. However, small and unseen buds continue their developed, becoming so new shoots during the experiment. Therefore, the buds of stump poplar were not fully developed and some of them have only scales and meristematic tissue before the experiment start. In addition, nitrogen uptake before bud break in stump poplars also induces root pressure enhancement and results in sap leak at the cutting area. The sap leak induces sap flow before bud break. Therefore, it is possible that some biochemical compounds (e.g. non structural carbon, and N compounds,) are mobilized. Then, biochemical compounds in roots were trans-located to above-ground and may influence bud development and the early bud break of stump poplars. However, in the one-year scion poplar, the root pressure before bud break was not sufficient to induce biochemical compounds mobilization from roots to above-ground (i.e. top and medium-main stems). Because the xylem sap leaked of the one-year scion was very small during high root pressure period. This is contradictory to results. Root pressure seems to be higher in intact plants of the one-year scion (Experiment I) than in stump poplar (Experiment II) (see Fig. 3.6 and Fig. 3.19). Therefore, uptake N on the one-year scion poplar has no effect on bud break.

In addition, low winter temperature (chilling) is the most important environmental factor regulating bud break in temperate trees (Heide, 2003; Linkosalo *et al.*, 2006; Myking and Heide, 1995). Number of previous studies indicate a strong relationship between winter temperature and dormancy release, implying that even small changes in winter temperature

could have large impacts on bud break timing, in spring (Heide, 2003; Linkosalo *et al.*, 2006; Myking, 1999; Myking and Heide, 1995; Partanen *et al.*, 1998; Yu *et al.*, 2010). Warm autumn temperatures also was reported to induce deep dormancy development enhancement, thus delaying bud break in northern ecotypes of birch (*Betula* sp.) (Heide, 2003). In this study, the role of winter temperature on poplar dormancy release and bud break timing was investigated in experiment III. Poplars transplanted outside greenhouse during winter were exposed to lower air temperature than plants remaining inside greenhouse. Bud break timing was also influenced by N factor when poplars rested inside greenhouse during winter. Poplars N uptake before bud break induced an early bud break. However, N factor has no effect on bud break timing when poplars were placed outside greenhouse during winter. Therefore, the low winter temperatures have a larger impact on bud break timing in poplars over the N uptake before bud break.

Number of New Shoot, Number of Leaf, Leaf Area, and Biomass of New Shoot

On temperate plants, changes in the biomass proportions of above-ground and below-ground depend on seasons (Pregitzer *et al.*, 1990). During bud break, poplars remobilize biochemical such as stored carbon and N to support new growth processes. Therefore, the biomass of below-ground decreased while the above-ground biomass increased. However, the biomass increase in above-ground relates to new shoot growing (Dyckmans and Flessa, 2001; Landhäusser and Lieffers, 2002; Landhäusser and Lieffers, 2003; Salaün *et al.*, 2005).

Supplying N before bud break has no effect on the number of bud break, and the number of leaf in one-year scion poplar. Because before start the experiment, plants have successive auxiliary bud formation that forms bud scales stipule and small leaf lamina. In the experiment, number of leaves was measured after bud break 15 days when new shoots showed first flush. During that time up taken N before bud break could not be transported from roots to buds before bud break. Therefore, the numbers of leaves investigated were those new leaves which have been formulated prior started experiment.

However, new shoot biomass and leaf area increased in accordance to an effect of uptake N before bud break. In response to the N uptake, the induction of early bud break, carbon assimilation increase, and new shoot growth enhancement are noted. These results are consistent with the studies of Change and Fuchigami (2002), Ripullone *et al.* (2003), Dong *et al.* (2004) and Cooke *et al.* (2005) who found that new shoot growth increment in plants is effected by N concentration enhancement in leaves. In addition, the modulation change of leaf

area represents alternative growth patterns by changing the rate of cell division and/or cell expansion. These mechanisms are adjusted by N availability (Cooke *et al.*, 2005).

4.4 Nitrogen Uptake before Bud Breaks Influence on Mineral Uptake

The effect of N uptake before bud break on mineral uptake (e.g. potassium and phosphorus uptakes curves in the one-year poplars – the Experiment I) revealed similar trend as in two-year poplars (Experiments II and III). The investigations on potassium and phosphorus uptake before bud break, in all experiments, show that potassium and phosphorus uptake before bud break was not related to N uptake before bud break. Potassium and phosphorus were up taken dramatically in plants after bud break because the leaf area developed and transpiration increased. Therefore, this study concludes that potassium and phosphorus is taken up independently.

In contrast to the strong results on potassium and phosphorus uptake, this study finds little evidence to support the effect of N uptake before bud break on calcium and magnesium uptakes. Figures 3.13, 3.26, and 3.33 show the different dynamic curves of calcium and magnesium uptake in the one-year and two-year poplars. The increase of calcium and magnesium uptakes, before and after bud break in the one-year poplar, is likely to play a role on N uptake. However, calcium and magnesium uptakes in the two-year poplar increasingly effused, before bud break and after bud break, in relation to N uptake. The differences in mineral uptake dynamic curves from the one-year and two-year poplars can be attributed to the effect of fine root turnover and root mortality, influencing calcium and magnesium uptakes. The fine root turnover and root mortality in the two-year poplar was higher than in the one-year poplar. Then, the root mortality affected minerals uptake by releasing some nutrients through the recirculating nutrient solution systems and this nutrients released impacted on the data collection of calcium and magnesium uptakes.

Chapter 5: General Conclusions and Recommendations

5.1 Conclusions

The hypothesis supported in this work is that physico-chemical characteristics of the root environment may be involved in quality of the axillary bud break and new shoots, originating from axillaries buds growth during early spring. Emphasis was placed on N supply during the critical phase of development. A well-defined experimental process was then used to discriminate the potential effect of N uptake before bud break and the restart of mineral uptake after bud break. This study purposes to fulfill such gap.

Therefore, the two main objectives are:

- (i) To quantify N uptake before bud break in poplars (*Populus tremula* × *Populus alba*, clone INRA 717-1B4), and
- (ii) Extent if N uptake before bud break may have a significant effect on re-growth development.

This study has been implemented on the different young plant structures deliberately choosing limited plants.

This study concludes that poplar (*Populus tremula* × *Populus alba*, clone INRA 717-1B4) can uptake N before bud break under the control of external conditions (i.e. temperature and substrate). The temperature in greenhouse and substrate was set at 15-20°C. In addition, N uptake before bud break was not dependent on calcium uptake and last winter temperature. However, plants could uptake N dramatically only within 8-10 days after N supply start, as N uptake decreases after. N was up taken again after bud break, when the leaf area and transpiration in new shoots increase. N uptake before bud break, in poplar, was controlled by plants internal conditions but could not be evidently clarified in this study. Therefore, N uptake before bud break seems be controlled, and/or limited, by the feedback regulation of stored N compounds in roots.

Nitrogen uptake in poplars, before bud break, impacts new growth development. N uptake before bud break was correlated to positive root pressure. The positive xylem pressure increased water content and refilled embolism in xylem before bud break. Therefore, poplars up taken N before bud break was less affected on their bud break timing. The bud break timing depends on stem shape, bud structure, and winter temperature. However, N uptake in poplars,

before bud break, had a significant effect on new shoot growth and development after bud break, by increase leaf area and dry weight. In addition, N uptake in poplars, before bud break, influenced N and non structural carbon reserves in compartment tissues. Nitrogen uptake before bud break increased N content in compartment tissues after bud break, especially in roots and new shoots. Contradictory, the non structural carbon (NSC) reserves decreased. This is because NSC was used for N uptake, N assimilation, induce root pressure, and new growth development. Moreover, the total NSC used in the one-year scion poplar showed that it was not totally recovered in new shoots (dry weight of new shoots) when plants were supplied with N before bud break. The finding of NSC used confirms the hypothesis that N uptake in poplars, before bud break, increases carbon assimilation through the raise of photosynthesis activity. Accordingly, the results of this study suggest that N supply in spring, before bud break, can modify plant development and new growth quality.

5.2 Recommendations

Study of N uptake in plants before bud break purposes to fulfill the gap of previous studies, undertaken research in the period when plants have leaves. This study found that poplars can uptake N before bud break and that this conveys significant effect on the development of new shoots. In order to fully explain N uptake in plants before bud break and its effect on new shoots quality, future studies should expand the research scope regarding the control mechanism of N uptake in plants before bud break, and their changes on N uptake and mobilization. Future research can also extend to the findings of this study whether the increase in N content in compartment tissues of plants comes from N uptake or N storage. Our results do not clarify whether the increase in N content in new shoots shortly after bud break is dues to N uptake and/or stimulation of N remobilization to new shoots. Unfortunately, N uptake and N remobilisation in tissues could not be resolved in these experiments and further experiments should use ^{15}N to answer this key question.

In addition, future studies can extend experimenting on larger and older structure plants, in the field; as well as on some plants able to uptake N before bud break (such as apple (Dong *et al.*, 2001), walnut (Ewer *et al.*, 2001), and maples (Delaire *et al.*, 2005)) to better investigate the general effect of N uptake on plant growth and development.

Chapter 6: References

- Ameglio, T., C. Bodet, A. Lacointe and H. Cochard 2002. Winter embolism, mechanisms of xylem hydraulic conductivity recovery and springtime growth patterns in walnut and peach trees. *Tree Physiology*. 22:1211-1220.
- Ameglio, T., F.W. Ewers, H. Cochard, M. Martignac, M. Vandame, C. Bodet and P. Cruiziat 2001. Winter stem xylem pressure in walnut trees: effects of carbohydrates, cooling and freezing. *Tree Physiology*. 21:387-394.
- Aylott, M.J., E. Casella, I. Tubby, N.R. Street, P. Smith and G. Taylor 2008. Yield and spatial supply of bioenergy poplar and willow short-rotation coppice in the UK. *New Phytologist*. 178:358-370.
- Bailey, J.D. and C.A. Harrington 2006. Temperature regulation of bud-burst phenology within and among years in a young Douglas-fir (*Pseudotsuga menziesii*) plantation in western Washington, USA. *Tree Physiology*. 26:421-430.
- Barbaroux, C., N. Breda and E. Dufrene 2003. Distribution of above-ground and below-ground carbohydrate reserves in adult trees of two contrasting broad-leaved species (*Quercus petraea* and *Fagus sylvatica*). *New Phytologist*. 157:605-615.
- Barthélémy, D. and Y. Caraglio 2007. Plant Architecture: A dynamic, multilevel and comprehensive approach to plant form, structure and ontogeny. *Annals of Botany*. 99:375-407.
- Beaujard, F., S. Haricot, V. Rasamison and R. Guisnel 2002. Rationalizing micro-cutting production of *Forsythia x intermedia*: management and mineral nutrition of the mother plants; evaluation of the resulting plants at the end of one growing season. Multiplication vegetative des ligneux forestiers, fruitiers et ornementaux, Troisieme Rencontre du Groupe de la Sainte Catherine. Orleans, France. 22-24 novembre 2000:1-13.
- Beaujard, F. and G. Hunault 1996. An original approach to study the kinetics of mineral element uptake for some woody species. *Acta Hort.* 435:243-253.
- Bergsdorf, E.Y., A.A. Zdebik and T.J. Jentsch 2009. Residues important for nitrate/proton coupling in plant and mammalian CLC transporters. *Journal of Biological Chemistry*. 284:11184-11193.
- Black, B.L., C.M. Parmentier-Line, L.H. Fuchigami and G.D. Coleman 2001. Ecotypic and genetic variation in poplar bark storage protein gene expression and accumulation. *Tree Physiology*. 21:1289-1297.
- Black, K.E., C.G. Harbron, M. Franklin, D. Atkinson and J.E. Hooker 1998. Differences in root longevity of some tree species. *Tree Physiology*. 18:259-264.

- Block, R., K. Van Rees and J. Knight 2006. A review of fine root dynamics in *Populus*. Plantations Agroforestry Systems. 67:73-84.
- Bloom, A.J., S.S. Sukrapanna and R.L. Warner 1992. Root respiration associated with ammonium and nitrate absorption and assimilation by barley. Plant Physiology. 99:1294-1301.
- Bollmark, L., L. Sennerby-Forsse and T. Ericsson 1999. Seasonal dynamics and effects of nitrogen supply rate on nitrogen and carbohydrate reserves in cutting-derived *Salix viminalis* plants. Canadian Journal of Forest Research-Revue Canadienne De Recherche Forestiere. 29:85-94.
- Bonhomme, M., M. Peuch, T. Ameglio, R. Rageau, A. Guilliot, M. Decourteix, G. Alves, S. Sakr and A. Lacoïnte 2009. Carbohydrate uptake from xylem vessels and its distribution among stem tissues and buds in walnut (*Juglans regia* L.). Tree Physiology. 30:89-102.
- Bradshaw, H.D., R. Ceulemans, J. Davis and R. Stettler 2000. Emerging model systems in plant biology: Poplar (*Populus*) as a model forest tree. Journal of Plant Growth Regulation. 19:306-313.
- Brunner, A.M., V.B. Busov and S.H. Strauss 2004. Poplar genome sequence: functional genomics in an ecologically dominant plant species. Trends in Plant Science. 9:49-56.
- Cesaraccio, C., D. Spano, R.L. Snyder and P. Duce 2004. Chilling and forcing model to predict bud-burst of crop and forest species. Agricultural and Forest Meteorology. 126:1-13.
- Chen, Y.F., Y. Wang and W.H. Wu 2008. Membrane transporters for nitrogen, phosphate and potassium uptake in plants. Journal of Integrative Plant Biology. 50:835-848.
- Cheng, L., F.W. Ma and D. Ranwala 2004. Nitrogen storage and its interaction with carbohydrates of young apple trees in response to nitrogen supply. Tree Physiology. 24:91-98.
- Cheng, L.L. and L.H. Fuchigami 2002. Growth of young apple trees in relation to reserve nitrogen and carbohydrates. Tree Physiology. 22:1297-1303.
- Clearwater, M.J., P. Blattmann, Z. Luo and R.G. Lowe 2007. Control of scion vigour by kiwifruit rootstocks is correlated with spring root pressure phenology. Journal of Experimental Botany. 58:1741-1751.
- Coleman, G.D., J.M. Englert, T.H.H. Chen and L.H. Fuchigami 1993. Physiological and environmental requirements for poplar (*Populus-Deltoides*) bark storage protein-degradation. Plant Physiology. 102:53-59.
- Coleman, M.D., R.E. Dickson and J.G. Isebrands 2000. Contrasting fine-root production, survival and soil CO₂ efflux in pine and poplar plantations. Plant and Soil 225:129-139.

- Coleman, M.D., A.L. Friend and C.C. Kern 2004. Carbon allocation and nitrogen acquisition in a developing *Populus deltoides* plantation. *Tree Physiology*. 24:1347-1357.
- Cooke, J.E.K., T.A. Martin and J.M. Davis 2005. Short-term physiological and developmental responses to nitrogen availability in hybrid poplar. *New Phytologist*. 167:41-52.
- Cooke, J.E.K. and M. Weih 2005. Nitrogen storage and seasonal nitrogen cycling in *Populus*: bridging molecular physiology and ecophysiology. *New Phytologist*. 167:19-30.
- Crawford, N.M. 1995. Nitrate nutrient and signal for plant-growth. *Plant Cell*. 7:859-868.
- Crawford, N.M. and A.D.M. Glass 1998. Molecular and physiological aspects of nitrate uptake in plants. *Trends in Plant Science*. 3:389-395.
- Curtis, P.S., C.S. Vogel, X.Z. Wang, K.S. Pregitzer, D.R. Zak, J. Lussenhop, M. Kubiske and J.A. Teeri 2000. Gas exchange, leaf nitrogen, and growth efficiency of *Populus tremuloides* in a CO₂-enriched atmosphere. *Ecological Applications*. 10:3-17.
- de Visser, R., K.S. Brouwer and F. Posthumus 1986. Alternative path mediated ATP synthesis in roots of *Pisum sativum* upon nitrogen supply. 295-300 pp.
- Decourteix, M., G. Alves, M. Bonhomme, M. Peuch, K. Ben Baaziz, N. Brunel, A. Guillot, R. Rageau, T. Ameglio, G. Petel and S. Sakr 2008. Sucrose (JrSUT1) and hexose (JrHT1 and JrHT2) transporters in walnut xylem parenchyma cells: their potential role in early events of growth resumption. *Tree Physiology*. 28:215-224.
- Delaire, M., (2005) Variations de la capacité d'absorption minérale par les racines du jeune *Acer pseudoplatanus*, L. (Acéracées) consécutives à l'histoire nutritionnelle récente et ancienne de la plante. PhD, Université d'Angers, Thesis n° 676, 181pp.
- Delaire, M., E. Frak, M. Sigogne, B. Adam, F. Beaujard and X. Le Roux 2005. Sudden increase in atmospheric CO₂ concentration reveals strong coupling between shoot carbon uptake and root nutrient uptake in young walnut trees. *Tree Physiology*. 25:229-235.
- Deng, X., S.A. Weinbaum, T.M. DeJong and T.T. Muraoka 1989. Utilization of nitrogen from storage and current-year uptake in walnut spurs during the spring flush of growth. *Physiologia Plantarum*. 75:492-498.
- DesRochers, A., R. van den Driessche and B.R. Thomas 2003. Nitrogen fertilization of trembling aspen seedlings grown on soils of different pH. *Canadian Journal of Forest Research-Revue Canadienne De Recherche Forestiere*. 33:552-560.
- DesRochers, A., R. van den Riessche and B.R. Thomas 2007. The interaction between nitrogen source, soil pH, and drought in the growth and physiology of three poplar clones. *Canadian Journal of Botany-Revue Canadienne De Botanique*. 85:1046-1057.
- Dickmann, D.I. and J. Kuzovkina 2008. *Poplars and willows of the world, with emphasis on silviculturally important species*. Rome, Italy: FAO Forest Management Division Working Paper IPC/9-2. 129 p
- Dickson, R.E. 1989. Carbon and nitrogen allocation in trees. *Ann. For. Sci.* 46:631s-647s.

- Dluzniewska, P., A. Gessler, H. Dietrich, J.P. Schnitzler, M. Teuber and H. Rennenberg 2007. Nitrogen uptake and metabolism in *Populus x canescens* as affected by salinity. *New Phytologist*. 173:279-293.
- Dluzniewska, P., A. Gessler, S. Kopriva, M. Strnad, O. Novak, H. Dietrich and H. Rennenberg 2006. Exogenous supply of glutamine and active cytokinin to the roots reduces NO_3^- uptake rates in poplar. *Plant Cell and Environment*. 29:1284-1297.
- Domenicano, S., L. Coll, C. Messier and F. Berninger 2011. Nitrogen forms affect root structure and water uptake in the hybrid poplar. *New Forests*:1-16.
- Dong, S.F., L.L. Cheng, C.F. Scagel and L.H. Fuchigami 2002. Nitrogen absorption, translocation and distribution from urea applied in autumn to leaves of young potted apple (*Malus domestica*) trees. *Tree Physiology*. 22:1305-1310.
- Dong, S.F., L.L. Cheng, C.F. Scagel and L.H. Fuchigami 2004. Nitrogen mobilization, nitrogen uptake and growth of cuttings obtained from poplar stock plants grown in different N regimes and sprayed with urea in autumn. *Tree Physiology*. 24:355-359.
- Dong, S.F., C.F. Scagel, L.L. Cheng, L.H. Fuchigami and P.T. Rygielwicz 2001. Soil temperature and plant growth stage influence nitrogen uptake and amino acid concentration of apple during early spring growth. *Tree Physiology*. 21:541-547.
- Dyckmans, J. and H. Flessa 2001. Influence of tree internal N status on uptake and translocation of C and N in beech: a dual C-13 and N-15 labeling approach. *Tree Physiology*. 21:395-401.
- Dyckmans, J., H. Flessa, Z. Shangguan and F. Beese 2000. A dual C-13 and N-15 long term labelling technique to investigate uptake and translocation of C and N in beech (*Fagus sylvatica* L.). *Isotopes in Environmental and Health Studies*. 36:63-78.
- Ehltling, B., P. Dluzniewska, H. Dietrich, A. Selle, M. Teuber, R. Hansch, U. Nehls, A. Polle, J.P. Schnitzler, H. Rennenberg and A. Gessler 2007. Interaction of nitrogen nutrition and salinity in Grey poplar (*Populus tremula x alba*). *Plant Cell and Environment*. 30:796-811.
- Ewers, F.W., T. Ameglio, H. Cochard, F. Beaujard, M. Martignac, M. Vandame, C. Bodet and P. Cruiziat 2001. Seasonal variation in xylem pressure of walnut trees: root and stem pressures. *Tree Physiology*. 21:1123-1132.
- Finzi, A.C., R.J. Norby, C. Calfapietra, A. Gallet-Budynek, B. Gielen, W.E. Holmes, M.R. Hoosbeek, C.M. Iversen, R.B. Jackson, M.E. Kubiske, J. Ledford, M. Liberloo, R. Oren, A. Polle, S. Pritchard, D.R. Zak, W.H. Schlesinger and R. Ceulemans 2007. Increases in nitrogen uptake rather than nitrogen-use efficiency support higher rates of temperate forest productivity under elevated CO_2 . *Proceedings of the National Academy of Sciences of the United States of America*. 104:14014-14019.

- Forde, B.G. 2000. Nitrate transporters in plants: structure, function and regulation. *Biochimica Et Biophysica Acta-Biomembranes*. 1465:219-235.
- Fracheboud, Y., V. Luquez, L. Bjorken, A. Sjodin, H. Tuominen and S. Jansson 2009. The control of autumn senescence in european aspen. *Plant Physiology*. 149:1982-1991.
- Frak, E., P. Millard, X. Le Roux, S. Guillaumie and R. Wendler 2002. Coupling sap flow velocity and amino acid concentrations as an alternative method to N-15 labeling for quantifying nitrogen remobilization by walnut trees. *Plant Physiology*. 130:1043-1053.
- Gansert, D. and W. Sprick 1998. Storage and mobilization of nonstructural carbohydrates and biomass development of beech seedlings (*Fagus sylvatica* L.) under different light regimes. *Trees-Structure and Function*. 12:247-257.
- Geisler-Lee, J., M. Geisler, P.M. Coutinho, B. Segerman, N. Nishikubo, J. Takahashi, H. Aspeborg, S. Djerbi, E. Master, S. Andersson-Gunneras, B. Sundberg, S. Karpinski, T.T. Teeri, L.A. Kleczkowski, B. Henrissat and E.J. Mellerowicz 2006. Poplar carbohydrate-active enzymes. Gene identification and expression analyses. *Plant Physiology*. 140:946-962.
- Gessler, A., S. Kopriva and H. Rennenberg 2004. Regulation of nitrate uptake at the whole-tree level: interaction between nitrogen compounds, cytokinins and carbon metabolism. *Tree Physiology*. 24:1313-1321.
- Gessler, A., S. Schneider, D. Von Sengbusch, P. Weber, U. Hanemann, C. Huber, A. Rothe, K. Kreutzer and H. Rennenberg 1998. Field and laboratory experiments on net uptake of nitrate and ammonium by the roots of spruce (*Picea abies*) and beech (*Fagus sylvatica*) trees. *New Phytologist*. 138:275-285.
- Glass, A.D., J.E. Shaff and K. L.V. 1992 Studies of the Uptake of Nitrate in Barley : IV. Electrophysiology. *Plant Physiology*. 99(2):456-463.
- Glass, A.D.M., D.T. Britto, B.N. Kaiser, J.R. Kinghorn, H.J. Kronzucker, A. Kumar, M. Okamoto, S. Rawat, M.Y. Siddiqi, S.E. Unkles and J.J. Vidmar 2002. The regulation of nitrate and ammonium transport systems in plants. *Journal of Experimental Botany*. 53:855-64.
- Gloser, V., M.A. Zwieniecki, C.M. Orians and N.M. Holbrook 2007. Dynamic changes in root hydraulic properties in response to nitrate availability. *Journal of Experimental Botany*. 58:2409-2415.
- Gorska, A., Q. Ye, N.M. Holbrook and M.A. Zwieniecki 2008a. Nitrate control of root hydraulic properties in plants: Translating local information to whole plant response. *Plant Physiology*. 148:1159-1167.
- Gorska, A., A. Zwieniecka, N.M. Holbrook and M.A. Zwieniecki 2008b. Nitrate induction of root hydraulic conductivity in maize is not correlated with aquaporin expression. *Planta*. 228:989-998.

- Grassi, G., P. Millard, P. Gioacchini and M. Tagliavini 2003. Recycling of nitrogen in the xylem of *Prunus avium* trees starts when spring remobilization of internal reserves declines. *Tree Physiology*. 23:1061-1068.
- Grassi, G., P. Millard, R. Wendler, G. Minotta and M. Tagliavini 2002. Measurement of xylem sap amino acid concentrations in conjunction with whole tree transpiration estimates spring N remobilization by cherry (*Prunus avium* L.) trees. *Plant Cell and Environment*. 25:1689-1699.
- Guak, S., D. Neilsen, P. Millard, R. Wendler and G.H. Neilsen 2003. Determining the role of N remobilization for growth of apple (*Malus domestica* Borkh.) trees by measuring xylem-sap N flux. *Journal of Experimental Botany*. 54:2121-2131.
- Guérin, V., L. Huche-Thelier and S. Charpentier 2007. Mobilisation of nutrients and transport via the xylem sap in a shrub (*Ligustrum ovalifolium*) during spring growth: N and C compounds and interactions. *Journal of Plant Physiology*. 164:562-573.
- Hannerz, M. 1998. Genetic and seasonal variation in hardiness and growth rhythm in boreal and temperate conifers: a review and annotated bibliography. *In SkogForsk report;no. 2*, 1998. Forerstry Research Institute of Sweden, Uppsala.
- Heide, O.M. 2003. High autumn temperature delays spring bud burst in boreal trees, counterbalancing the effect of climatic warming. *Tree Physiology*. 23:931-936.
- Heilman, P.E. 1999. Planted forests: poplars. *New Forests*. 17:89-93.
- Hendrick, R.L. and K.S. Pregitzer 1993. The dynamics of fine root length, biomass, and nitrogen content in two northern hardwood ecosystems. *Canadian Journal of Forest Research*. 23:2507-2520.
- Hendrick, R.L. and K.S. Pregitzer 1996. Temporal and depth-related patterns of fine root dynamics in northern hardwood forests. *Journal of Ecology*. 84:167-176.
- Higuchi, H. and T. Sakuratani 2006. Water Dynamics in Mango (*Mangifera indica* L.) Fruit during the Young and Mature Fruit Seasons as Measured by the Stem Heat Balance Method. *Journal of the Japanese Society for Horticultural Science*. 75:11-19.
- Imsande, J. and B. Touraine 1994. N demand and the regulation of nitrate uptake. *Plant Physiology*. 105:3-7.
- International Poplar Commission 23rd Session Beijing, C., 27 – 30 October 2008. Synthesis of country progress reports activities related to poplar and willow cultivation and utilization, 2004 through 2007 p. 65.
- Jansson, S. and C.J. Douglas 2007. *Populus: A model system for plant biology*. *Annual Review of Plant Biology*. 58:435-458.
- Jordan, M.O., G. Vercambre, J. Le Bot, S. Adamowicz, L. Gomez and L. Pages 2011. Autumnal nitrogen nutrition affects the C and N storage and architecture of young peach trees. *Trees-Structure and Function*. 25:333-344.

- Kalcsits, L.A., S. Silim and K. Tanino 2009. Warm temperature accelerates short photoperiod-induced growth cessation and dormancy induction in hybrid poplar (*Populus x spp.*). *Trees-Structure and Function*. 23:971-979.
- Karp, A. and I. Shield 2008. Bioenergy from plants and the sustainable yield challenge. *New Phytologist*. 179:15-32.
- Keskitalo, J., G. Bergquist, P. Gardeström and S. Jansson 2005. A cellular timetable of autumn senescence. *Plant Physiology*. 139:1635-1648.
- Kigalu, J.M. 2007. Effects of planting density on the productivity and water use of tea (*Camellia sinensis* L.) clones: I. Measurement of water use in young tea using sap flow meters with a stem heat balance method. *Agricultural Water Management*. 90:224-232.
- King, B.J., M.Y. Siddiqi, T.J. Ruth, R.L. Warner and A.D.M. Glass 1993. Feedback regulation of nitrate influx in barley roots by nitrate, nitrite, and ammonium. *Plant Physiology*. 102:1279-1286.
- Kirkby, E.A. and M.J. Armstrong 1980. Nitrate uptake by roots as regulated by nitrate assimilation in the shoot of sator oil Plants. *Plant Physiol*. 65(2):286-290.
- Kosola, K., D. Dickmann, E. Paul and D. Parry 2001. Repeated insect defoliation effects on growth, nitrogen acquisition, carbohydrates, and root demography of poplars. *Oecologia*. 129:65-74.
- Kubiske, M.E., K.S. Pregitzer, C.J. Mikan, D.R. Zak, J.L. Maziasz and J.A. Teeri 1997. *Populus tremuloides* photosynthesis and crown architecture in response to elevated CO₂ and soil N availability. *Oecologia Berlin*. 110:328-336.
- Kuden, A.B., M. Kasaka and E. Tanriver 1995. Determining the chilling requirements and growing degree hours of some pistachio nut cultivars and regions. *Acta Horticulturae*. 419:85-90.
- Kunkle, J.M., M.B. Walters and R.K. Kobe 2009. Senescence-related changes in nitrogen in fine roots: mass loss affects estimation. *Tree Physiology*. 29:715-723.
- Lacointe, A. 2000. Carbon allocation among tree organs: A review of basic processes and representation in functional-structural tree models. *Annals of Forest Science*. 57:521-533.
- Landhäuser, S.M. and V.J. Lieffers 2002. Leaf area renewal, root retention and carbohydrate reserves in a clonal tree species following above-ground disturbance. *Journal of Ecology*. 90:658-665.
- Landhäuser, S.M. and V.J. Lieffers 2003. Seasonal changes in carbohydrate reserves in mature northern *Populus tremuloides* clones. *Trees-Structure and Function*. 17:471-476.
- Langheinrich, U. 1993. Clonal variation in apical growth and content in vegetative storage proteins in *Populus*. *Trees-Structure and Function*. 7:242-249.

- Lautner, S., B. Ehlting, E. Windeisen, H. Rennenberg, R. Matyssek and J. Fromm 2007. Calcium nutrition has a significant influence on wood formation in poplar. *New Phytologist*. 173:743-752.
- Lautner, S. and J. Fromm 2010. Calcium-dependent physiological processes in trees. *Plant Biology*. 12:268-274.
- Lawlor, D.W. 2009. Musings about the effects of environment on photosynthesis. *Annals of Botany*. 103:543-549.
- Linkosalo, T., R. Hakkinen and H. Hanninen 2006. Models of the spring phenology of boreal and temperate trees: is there something missing? *Tree Physiology*. 26:1165-1172.
- Ludovici, K.H., H.L. Allen, T.J. Albaugh and P.M. Dougherty 2002. The influence of nutrient and water availability on carbohydrate storage in loblolly pine. *Forest Ecology and Management*. 159:261-270.
- Luo, Z.B., C. Calfapietra, M. Liberloo, G. Scarascia-Mugnozza and A. Polle 2006. Carbon partitioning to mobile and structural fractions in poplar wood under elevated CO² (EUROFACE) and N fertilization. *Global Change Biology*. 12:272-283.
- Luo, Z.B., C. Calfapietra, G. Scarascia-Mugnozza, M. Liberloo and A. Polle 2008. Carbon-based secondary metabolites and internal nitrogen pools in *Populus nigra* under Free Air CO² Enrichment (FACE) and nitrogen fertilisation. *Plant and Soil*. 304:45-57.
- Malaguti, D., P. Millard, R. Wendler, A. Hepburn and M. Tagliavini 2001. Translocation of amino acids in the xylem of apple (*Malus domestica* Borkh.) trees in spring as a consequence of both N remobilization and root uptake. *Journal of Experimental Botany*. 52:1665-1671.
- Marmann, P., R. Wendler, P. Millard and H. Heilmeyer 1997. Nitrogen storage and remobilization in ash (*Fraxinus excelsior*) under field and laboratory conditions. *Trees-Structure and Function*. 11:298-305.
- Maurel, K., G.B. Leite, M. Bonhomme, A. Guilliot, R. Rageau, G. Petel and S. Sakr 2004. Trophic control of bud break in peach (*Prunus persica*) trees: a possible role of hexoses. *Tree Physiology*. 24:579-588.
- Mayrhofer, S., U. Heizmann, E. Magel, M. Eiblmeier, A. Muller, H. Rennenberg, R. Hampp, J.P. Schnitzler and J. Kreuzwieser 2004. Carbon balance in leaves of young poplar trees. *Plant Biology*. 6:730-739.
- Millard, P. 1994. Measurement of the remobilization of nitrogen for spring leaf growth of trees under field conditions. *Tree Physiology*. 14:1049-1054.
- Millard, P. 1996. Ecophysiology of the internal cycling of nitrogen for tree growth. *Zeitschrift Fur Pflanzenernahrung Und Bodenkunde*. 159:1-10.
- Millard, P. and G.A. Grelet 2010. Nitrogen storage and remobilization by trees: ecophysiological relevance in a changing world. *Tree Physiology*. 1083-1095.

- Millard, P., A. Hester, R. Wendler and G. Baillie 2001. Interspecific defoliation responses of trees depend on sites of winter nitrogen storage. *Functional Ecology*. 15:535-543.
- Millard, P. and G.H. Neilsen 1989. The Influence of nitrogen supply on the uptake and remobilization of stored N for the seasonal growth of apple trees. *Annals of Botany*. 63:301-309.
- Millard, P. and M.F. Proe 1991. Leaf demography and the seasonal internal cycling of nitrogen in sycamore (*Acer pseudoplatanus* L.) seedlings in relation to nitrogen supply. *New Phytologist*. 117:587-596.
- Millard, P. and M.F. Proe 1993. Nitrogen uptake, partitioning and internal cycling in *Picea sitchensis* (Bong.) Carr. as influenced by nitrogen supply. *New Phytologist*. 125:113-119.
- Millard, P. and C.M. Thomson 1989. The Effect of the autumn senescence of leaves on the internal cycling of nitrogen for the spring growth of apple trees. *Journal of Experimental Botany*. 40:1285-1289.
- Millard, P., R. Wendler, G. Grassi, G.A. Grelet and M. Tagliavini 2006. Translocation of nitrogen in the xylem of field-grown cherry and poplar trees during remobilization. *Tree Physiology*. 26:527-536.
- Millard, P., R. Wendler, A. Hepburn and A. Smith 1998. Variations in the amino acid composition of xylem sap of *Betula pendula* Roth. trees due to remobilization of stored N in the spring. *Plant, Cell & Environment*. 21:715-722.
- Miller, A.J. and M.D. Cramer 2004. Root nitrogen acquisition and assimilation. *Plant and Soil*. 274:1-36.
- Miller, A.J., X.R. Fan, M. Orsel, S.J. Smith and D.M. Wells 2007. Nitrate transport and signalling. *Journal of Experimental Botany*. 58:2297-2306.
- Miller, A.J., X.R. Fan, Q.R. Shen and S.J. Smith 2008. Amino acids and nitrate as signals for the regulation of nitrogen acquisition. *Journal of Experimental Botany*. 59:111-119.
- Miller, A.J. and S.J. Smith 1996. Nitrate transport and compartmentation in cereal root cells. *Journal of Experimental Botany*. 47:843-854.
- Millett, J., P. Millard, A.J. Hester and A.J.S. McDonald 2005. Do competition and herbivory alter the internal nitrogen dynamics of birch saplings? *New Phytologist*. 168:413-422.
- Molmann, J.A., D.K.A. Asante, J.B. Jensen, M.N. Krane, A. Ernsten, O. Juntila and J.E. Olsen 2005. Low night temperature and inhibition of gibberellin biosynthesis override phytochrome action and induce bud set and cold acclimation, but not dormancy in PHYA overexpressors and wild-type of hybrid aspen. *Plant Cell and Environment*. 28:1579-1588.
- Muñoz, N., J. Guerri, F. Legaz and E. Primo-millo 1993. Seasonal uptake of ¹⁵N-nitrate and distribution of absorbed nitrogen in peach trees *Plant and Soil*. 150:263-269.

- Myking, T. 1999. Winter dormancy release and budburst in *Betula pendula* Roth and *B. pubescens* Ehrh. ecotypes. *Phyton*. 39:139-146.
- Myking, T. and O.M. Heide 1995. Dormancy release and chilling requirement of buds of latitudinal ecotypes of *Betula pendula* and *B. pubescens*. *Tree Physiology*. 15:697-704.
- Neilsen, D., P. Millard, G.H. Neilsen and E.J. Hogue 1997. Sources of N for leaf growth in a high-density apple (*Malus domestica*) orchard irrigated with ammonium nitrate solution. *Tree Physiology*. 17:733-739.
- Nicodemus, M.A., K.F. Salifu and D.F. Jacobs 2008. Nitrate reductase activity and nitrogen compounds in xylem exudate of *Juglans nigra* seedlings: relation to nitrogen source and supply. *Trees-Structure and Function*. 22:685-695.
- Orgeas, J., J.M. Ourcival and G. Bonin 2003. Seasonal and spatial patterns of foliar nutrients in cork oak (*Quercus suber* L.) growing on siliceous soils in Provence (France). *Plant Ecology*. 164:201-211.
- Otto, G.M., A.C.V. Motta and C.B. Reissman 2007. Poplar (*Populus deltoides* Marsh) response to nitrogen addition at two sites in sao Mateus do Sul, Pr. *Ciencia Florestal*. 17:81-90.
- Ow, L.F., D. Whitehead, A.S. Walcroft and M.H. Turnbull 2010. Seasonal variation in foliar carbon exchange in *Pinus radiata* and *Populus deltoides*: respiration acclimates fully to changes in temperature but photosynthesis does not. *Global Change Biology*. 16:288-302.
- Ozbuca, T.B., H.G. Kutbay, D. Kilic, H. Korkmaz, A. Bilgin, E. Yalcin and Z. Apaydin 2008. Foliar resorption of nutrients in selected sympatric tree species in gallery forest (Black Sea region). *Polish Journal of Ecology*. 56:227-237.
- Partanen, J., V. Koski and H. Hanninen 1998. Effects of photoperiod and temperature on the timing of bud burst in Norway spruce (*Picea abies*). *Tree Physiology*. 18:811-816.
- Pitre, F.E., J.E.K. Cooke and J.J. Mackay 2007. Short-term effects of nitrogen availability on wood formation and fibre properties in hybrid poplar. *Trees-Structure and Function*. 21:249-259.
- Policarpo, M., L.D. Marco, T. Caruso, P. Gioacchini and M. Tagliavini 2002. Dynamics of nitrogen uptake and partitioning in early and late fruit ripening peach (*Prunus persica*) tree genotypes under a mediterranean climate. *Plant Soil*. 239:207-214.
- Pregitzer, K.S., D.I. Dickmann, R. Hendrick and P.V. Nguyen 1990. Whole-tree carbon and nitrogen partitioning in young hybrid poplars. *Tree Physiology*. 7:79-93.
- Pregitzer, K.S., D.R. Zak, J. Maziasz, J. DeForest, P. S.Curtis and J. Lussenhop 2000. The interactive effects of atmospheric CO₂ and soil-N availability on fine roots of *Populus tremuloides*. *Ecological Applications*. 10:18-33.

- Quartieri, M., P. Millard and M. Tagliavini 2002. Storage and remobilisation of nitrogen by pear (*Pyrus communis* L.) trees as affected by timing of N supply. *European Journal of Agronomy*. 17:105-110.
- Regier, N., S. Streb, C. Coccozza, M. Schaub, P. Cherubini, S.C. Zeeman and B. Frey 2009. Drought tolerance of two black poplar (*Populus nigra* L.) clones: contribution of carbohydrates and oxidative stress defence. *Plant Cell and Environment*. 32:1724-1736.
- Regier, N., S. Streb, S.C. Zeeman and B. Frey 2010. Seasonal changes in starch and sugar content of poplar (*Populus deltoides* x *P. nigra* cv. Dorskamp) and the impact of stem girdling on carbohydrate allocation to roots. *Tree Physiology*. 30:979-987.
- Rennenberg, H., M. Dannenmann, A. Gessler, J. Kreuzwieser, J. Simon and H. Papen 2009. Nitrogen balance in forest soils: nutritional limitation of plants under climate change stresses. *Plant Biology*. 11:4-23.
- Rennenberg, H., H. Wildhagen and B. Ehling 2010. Nitrogen nutrition of poplar trees. *Plant Biology*. 12:275-291.
- Richardson, E.A., S.D. Seeley, D.R. Walker, J.L. Anderson and G.L. Ashcroft 1975. Phenoclimatology of spring peach bud development. *HortScience*. 10:236-237.
- Ripullone, F., G. Grassi, M. Lauteri and M. Borghetti 2003. Photosynthesis-nitrogen relationships: interpretation of different patterns between *Pseudotsuga menziesii* and *Populus x euroamericana* in a mini-stand experiment. *Tree Physiology*. 23:137-144.
- Ripullone, F., M. Lauteri, G. Grassi, M. Amato and M. Borghetti 2004. Variation in nitrogen supply changes water-use efficiency of *Pseudotsuga menziesii* and *Populus x euroamericana*; a comparison of three approaches to determine water-use efficiency. *Tree Physiology*. 24:671-679.
- Rohde, A. and R.P. Bhalerao 2007. Plant dormancy in the perennial context. *Trends in Plant Science*. 12:217-223.
- Rohde, A., E. Prinsen, R. De Rycke, G. Engler, M. Van Montagu and W. Boerjan 2002. PtABI3 impinges on the growth and differentiation of embryonic leaves during bud set in poplar. *Plant Cell*. 14:1885-1901.
- Rohde, A., T. Ruttink, V. Hostyn, L. Sterck, K. Van Driessche and W. Boerjan 2007. Gene expression during the induction, maintenance, and release of dormancy in apical buds of poplar. *Journal of Experimental Botany*. 58:4047-4060.
- Rowe, D.B., F.A. Blazich and C.D. Raper 2002. Nitrogen nutrition of hedged stock plants of Loblolly Pine. I. Tissue nitrogen concentrations and carbohydrate status. *New Forests*. 24:39-51.
- Ruttink, T., M. Arend, K. Morreel, V. Storme, S. Rombauts, J. Fromm, R.P. Bhalerao, W. Boerjan and A. Rohde 2007. A molecular timetable for apical bud formation and dormancy induction in poplar. *Plant Cell*. 19:2370-2390.

- Sakuratani, T. 1981. A heat balance method for measuring water flux in the stem of intact plants. *J. Agric. Meteorol.* **37**:9-17.
- Sakuratani, T. 1984. Improvement of the probe for measuring water flow rate in intact plants with the stem heat balance method. *J. Agric. Meteorol.* **40**:273-277.
- Salaün, M., V. Guérin, L. Huché-Théliér, S. Charpentier and F.L. Dily 2005. Nitrogen storage and mobilisation for spring growth in *Ligustrum* cultivated in container. *Scientia Horticulturae.* **103**:461-471.
- Sasakawa, H. and T.A. Larue 1986. Root respiration associated with nitrate assimilation by cowpea. *Plant Physiology.* **81**:972-975.
- Sauter, J.J. and B. Vancleve 1992. Seasonal variation of amino-acids in the xylem sap of *Populus x canadensis* and its relation to protein body mobilization. *Trees-Structure and Function.* **7**:26-32.
- Sauter, J.J. and B. Vancleve 1994. Storage, mobilization and interrelations of starch, sugars, protein and fat in the ray storage tissue of poplar trees. *Trees-Structure and Function.* **8**:297-304.
- Schmidt, S. and G.R. Stewart 1998. Transport, storage and mobilization of nitrogen by trees and shrubs in the wet/dry tropics of northern Australia. *Tree Physiology.* **18**:403-410.
- Silla, F. and A. Escudero 2003. Uptake, demand and internal cycling of nitrogen in saplings of Mediterranean *Quercus* species. *Oecologia.* **136**:28-36.
- Steele, S.J., S.T. Gower, J.G. Vogel and J.M. Norman 1997. Root mass, net primary production and turnover in aspen, jack pine and black spruce forests in Saskatchewan and Manitoba, Canada. *Tree Physiology.* **17**:577-587.
- Stenvall, N., M. Piisila and P. Pulkkinen 2009. Seasonal fluctuation of root carbohydrates in hybrid aspen clones and its relationship to the sprouting efficiency of root cuttings. *Canadian Journal of Forest Research-Revue Canadienne De Recherche Forestiere.* **39**:1531-1537.
- Tagliavini, M., P. Millard and M. Quartieri 1998. Storage of foliar-absorbed nitrogen and remobilization for spring growth in young nectarine (*Prunus persica* var. nectarina) trees. *Tree Physiology.* **18**:203-207.
- Tagliavini, M., P. Millard, M. Quartieri and B. Marangoni 1999. Timing of nitrogen uptake affects winter storage and spring remobilisation of nitrogen in nectarine (*Prunus persica* var. nectarina) trees. *Plant and Soil.* **211**:149-153.
- Tagliavini, M., M. Quartieri and P. Millard 1997. Remobilised nitrogen and root uptake of nitrate for spring leaf growth, flowers and developing fruits of pear (*Pyrus communis* L.) trees. *Plant and Soil.* **195**:137-142.

- Ter Steege, M.W., I. Stulen, P.K. Wiersema, F. Posthumus and W. Vaalburg 1999. Efficiency of nitrate uptake in spinach: impact of external nitrate concentration and relative growth rate on nitrate influx and efflux. *Plant and Soil*. 208:125-134.
- Tian, W.M., S.Q. Peng, B.Z. Hao, J.L. Wu, Z.H. Hu and K.M. Cui 2005. Poplar trees (*Populus canadensis* Moench) initiate vegetative storage protein accumulation during new shoot development in spring. *Journal of Integrative Plant Biology*. 47:717-725.
- Touraine, B., B. Muller and C. Grignon 1992. Effect of phloem-translocated malate on NO_3^- uptake by roots of intact soybean plants. *Plant Physiology*. 99:1118-1123.
- Valancogne C, Nasr Z (1989) Measuring sap flow in the stem of small trees by a heat balance method. *Hortscience* 24, 383-385.
- van den Driessche, R., B.R. Thomas and D.P. Kamelchuk 2008. Effects of N, NP, and NPKS fertilizers applied to four-year old hybrid poplar plantations. *New Forests*. 35:221-233.
- Vidmar, J.J., D. Zhuo, M.Y. Siddiqi, J.K. Schjoerring, B. Touraine and A.D.M. Glass 2000. Regulation of high-affinity nitrate transporter genes and high-affinity nitrate influx by nitrogen pools in roots of barley. *Plant Physiology*. 123:307-318.
- Vizoso, S., D. Gerant, J.M. Guehl, R. Joffre, M. Chalot, P. Gross and P. Maillard 2008. Do elevation of CO_2 concentration and nitrogen fertilization alter storage and remobilization of carbon and nitrogen in pedunculate oak saplings? *Tree Physiology*. 28:1729-1739.
- Weinbaum, S. and C. Van Kessel 1998. Quantitative estimates of uptake and internal cycling of ^{14}N -labeled fertilizer in mature walnut trees. *Tree Physiology*. 18:795-801.
- Welling, A., T. Moritz, E.T. Palva and O. Junttila 2002. Independent activation of cold acclimation by low temperature and short photoperiod in hybrid aspen. *Plant Physiology*. 129:1633-1641.
- Wells, C.E. and D.M. Eissenstat 2001. Marked differences in survivorship among apple roots of different diameter. *Ecology* 83:882-892.
- Wendler, R. and P. Millard 1996. Impacts of water and nitrogen supplies on the physiology, leaf demography and nitrogen dynamics of *Betula pendula*. *Tree Physiology*. 16:153-159.
- Witt, W. and J.J. Sauter 1994. Starch metabolism in poplar wood ray cells during spring mobilization and summer deposition. *Physiologia Plantarum*. 92:9-16.
- Wong, B.L., K.L. Baggett and A.H. Rye 2003. Seasonal patterns of reserve and soluble carbohydrates in mature sugar maple (*Acer saccharum*). *Canadian Journal of Botany- Revue Canadienne De Botanique*. 81:780-788.
- Wyckoff, G.W. and J.C. Zasada 2007. *Populus* L. In *Woody Plant Seed Manual*. In: Dickmann, D. I. and Kuzovkina, J. (2008): *Poplars and willows of the world, with emphasis*

- on Silviculturally Important Species. FAO Forest Management Division Working Paper IPC/9-2; :129.
- Yin, C.Y., X.Y. Pang and K. Chen 2009. The effects of water, nutrient availability and their interaction on the growth, morphology and physiology of two poplar species. *Environmental and Experimental Botany*. 67:196-203.
- Yu, H., E. Luedeling and J. Xu 2010. Winter and spring warming result in delayed spring phenology on the Tibetan Plateau. *Proceedings of the National Academy of Sciences*. 107(51):22151-22156.
- Yuan, Z. and H. Chen 2010. Changes in nitrogen resorption of trembling aspen (*Populus tremuloides*) with stand development. *Plant and Soil*. 327:121-129.
- Zhen, R.-G., H.-W. Koyro, R.A. Leigh, A.D. Tomos and A.J. Miller 1991. Compartmental nitrate concentrations in barley root cells measured with nitrate-selective microelectrodes and by single-cell sap sampling. *Planta*. 185 356-361.

Chapter 7: Appendix

7.1 Nutrient Uptake Measurement

Poplar is fast growing plant which highly consumes nutrients for growth, particularly nitrogen. The nutrient uptake of plant depends on its life cycle and environment (e.g. temperature, water and nutrient availability). Several studies showed that the changes of nitrogen availability in poplars during growth season have notably effect on the processes of plant growth and plant physiology (Cooke *et al.*, 2005; Pitre *et al.*, 2007; Ripullone *et al.*, 2003; Ripullone *et al.*, 2004). However, few studies have focused on the effect of nitrogen uptake before bud break on quality of re-growth. Therefore, the main purpose of this study is to investigate nutrient uptake of poplar before bud break.

This study uses the indirect method for collecting data of nutrient uptake. The method is selected in order to avoid the effect on plant structure that created by other methods that will impact on nutrient uptake for growth. For example, the direct method collects and analyzes data from root samples and sap xylem. Thus, collecting data by the direct method will effect on plant structure. In relation to the indirect method, the net mineral uptake is calculated by the differentiation between initial and final ion content in the nutrient solution.

7.1.1 Recirculating Nutrient System

Poplars were planted via the soilless culture, called the recirculation system (Fig. 7.1). In relation to the system, plants were grown in a limited volume, particular root development. Therefore, it allows researcher to be easy to access the measurement of mineral absorption. The recirculation system contains tank for store nutrient solution and cylindrical containers (diameter \times height = 0.20 \times 0.30 m) with perlite for plants culture. Perlite is used as a neutral substrate to without capability to exchange ionic charge with the aqueous phase. The recirculation system will flow solutions pass through substrate and then revolve back to the tank. The system cycle will provide solutions for plants until equilibrate the quality of solutions at each point of the system (i.e. substrate of plants and tank) and then solution will flow back to the tank and the recirculation process is terminated. This process will produce a mineral balance for each sampling – all elements of solution leaving the system are uptaken by plants (except the leak). Therefore, the calculation of nutrient uptake of plants requires information of the total water content and concentration of each mineral element before and after supply nutrient solution. The recirculation system is automatic drip-irrigated with the 80

liter nutrient solution that was recirculated for 1 hour six times per day (ever four hours) to ensure the non-limiting supplied of water and nutrients.

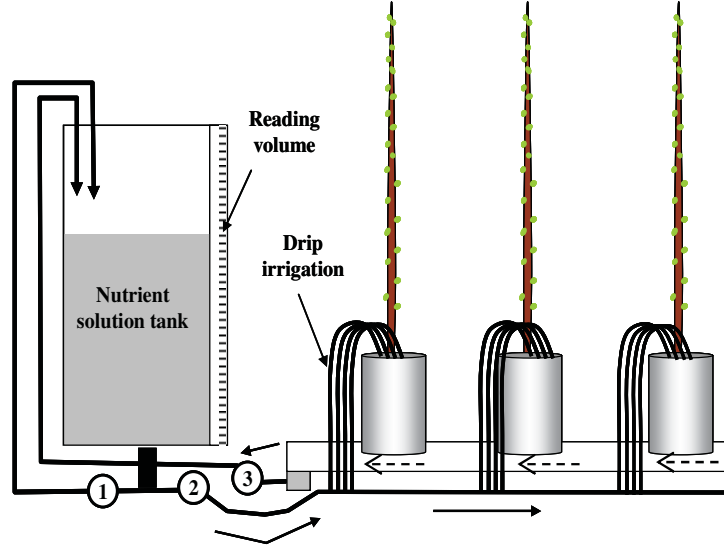

Fig. 7.1 : Schematic representation of recirculating nutrient system 1: mixing pump, 2: irrigating pump, and 3: recovering pump

7.1.2 Computation of Nutrient Uptake

Nutrient uptake was calculated by took a sample of 0.06 l of nutrient solution and measured tank volume after each watering event 1 hour. This study sampled nutrient solution two times a day: at 9.00 and 17.00. The sampled solutions were analyzed by the HPLC Metrohm Bioscan system (Metrohm France-91942 Courtaboeuf - France) with Metrosep C2 250 x 4.0 mm column for cations (K^+ , Ca^{2+} , Mg^{2+} and NH_4^+) and Metrosep A SUPP7 250 x 4.0 mm column for anions (NO_3^- , NO_2^- , HPO_4^{3-} , SO_4^{2-} and Cl^-). Then, the quantity of plant uptake nutrient was estimated by the model of Beaujard and Hunault (1996):

$$Q_{abs} = \frac{1}{N} \left(- \sum_{i=1}^{i=n} [C_{i-1} \cdot (\Delta V - V_e) + \Delta C \cdot (V_i + V_p)] \right) \quad (1)$$

Q_{abs} = Nutrient uptake ($mmol \text{ tree}^{-1}$), C_{i-1} = Concentration of nutrient in the tank at sampling time from $i = 1$ to n ($mmol \text{ l}^{-1}$), ΔC and ΔV = Variation in concentration and volume between two sampling time from T_{i-1} to T_i respectively; ($i = 1$ to n), V_e = Sample volume for laboratory analysis (l), V_i = Solution volume in the tank at sampling time from $i = 1$ to n (l), V_p = Volume of solution retained in the perlite substrate (l) and N = Number of plants.

In order to ensure data continuity when the nutrient was renewed, Equation 2 was used to compute the hypothetical concentration applied at the time of renewal:

$$C'_{i-1} = \frac{(C_r V_r + V_p C_p)}{V_r + V_p} \quad (2)$$

Where: C'_{i-1} = Hypothetical concentration of nutrient in the tank at the time of renewal (mmol l^{-1}); C_r = Concentration of the newly made solution (mmol l^{-1}); and C_p = Concentration of the last sample before nutrient solution renewal (nutrient solution concentration in the perlite substrate at the time of nutrient renewal) (mmol l^{-1}); V_r = Volume of the newly made solution (l).

7.2 Root Pressure Measurement

Root pressure occurs in xylem when the moisture level of soil or substrate is high while plants have low transpiration. Plants with high transpiration have the under tension of xylem sap rather than the under pressure due to transpiration pull. Root pressure is caused by active transport of mineral nutrient ions into the root xylem. Thus, without transpiration to carry the ions up to stem, such ions accumulate in the root xylem and lower water potential. Water diffuses from the soil into the root xylem due to osmosis and then root pressure is caused by this accumulation of water in xylem pushing.

All experiments of this study have been undertaken during the end of winter to the start of spring. In that period, poplars have no leaf with low transpiration. Experiment was done under a hypothesis that whether poplars uptake nitrogen before bud break. If plants can uptake nitrate before bud break, root pressure will be occurred. Root pressure and xylem sap pressure is important process to support refilling embolism of plants. Therefore, the root pressure may influence on the changes of bud break time and the quality of new shoots.

Investigating root pressure of plants is analyzed by removing the shoots close to soil level. Xylem sap will exude from cut stem due to root pressure. When a pressure gauge is attached to the cut stem, the root pressure can be measured. However, instrument for measuring root pressure of this experiment was adapted to avoid cutting stem above-ground. Root pressure data in this study was collected by connecting sensors and xylem via stainless steel hypodermic needles at below ground stem. Then, connecting deionizer water between

pressure censer and sap xylem; therefore, this study assumes that the xylem pressures are come from root activity.

Materials and Methods

Root pressure is measured by the pressure transducer (Model 26PC Series Pressure Sensors, Honeywell LTD, USA), which is connected with data loggers (DL2e; Delta-T Devices, Cambridge, U.K.) in order to record data. Xylem and pressure sensors are connected by the stainless steel hypodermic needles (Beaujard, unpublished; Clearwater *et al.*, 2007) and deionizer water is connected between pressure censer and sap xylem. In relation to the method, it should be carefully connected the instruments to avoid solution leak between a stem and a sensor (Fig. 7.2). Processes for connecting instruments are shown as follow:

1. Join pressure censer with the 3-ways valves.
2. Use a small triangular file, gently file a notch opposite site at 1.9 and 2.0 cm from the base of stainless steel hypodermic needles. Then, cut the needles at 2.1 cm.
3. Drill a hole at the stem locates around 15 cm from floor. Size of the hole is similar to needle. Pierce to xylem and then clean with deionizer water.
4. Bring stainless steel hypodermic needle put into the hole. The notch opposite site must locate at xylem. Use par film to protect the leak out and then tightly fix the needle with tree tie.
5. Connect pressure censer and sap xylem with deionizer water. Fill in deionizer water in pressure censer and stainless steel hypodermic needles. The deionizer water is filled until there is no air in such censer and needles, and then connects both pressure censer and sap xylem together.
6. Give electric current 10 ± 0.01 Vdc to pressure censer and connects with data loggers (DL2e; Delta-T Devices, Cambridge, U.K.).

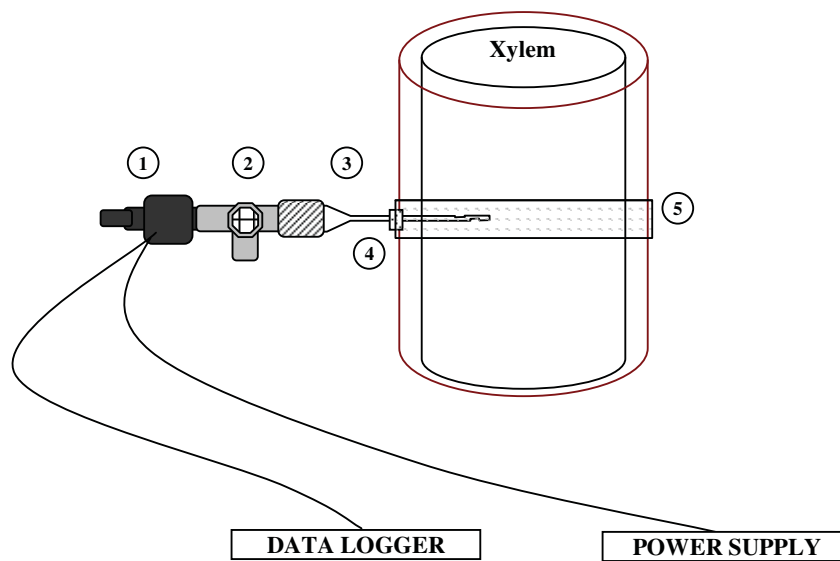

Fig. 7.2 : Xylem sap pressure measurement, pressure transducer (1), 3-ways valve (2), Stainless steel hypodermic needle (3), Par film (4), Tree tie (5)

7.3 Sap Flow Heat Balance Measurement

The mobilization of sap during early stage of re-growth in spring of plant presents the development, quality, transpiration of leaves or new shoots. The mobilization of sap also increases the translocation of nitrogen and carbon content in organic compound and mineral from the storage organs to new sinks. The focus of this study is on whether uptake nitrogen on plant before bud break effects on the mobilization of sap or transpiration of plant.

The stem heat balance method is selected for collecting data of sap flow because by this method it is not cause any injury on plant. Otherwise, data of root pressure when plant is supplied nitrogen could not be collected. In relation to this method, the sensors are pasted the trunk of plant, e.g. flexible heater and thermocouple. The method was originally proposed by Sakuratani (1981) to measure the sap flow rate of the sap stream in herbaceous plants. In addition, the stem heat balance has been found to be applicable to stems and trunks of about 2-150 mm in diameter such as stem and peduncle of the mango inflorescence (Higuchi and Sakuratani, 2005) and young tea (*Camellia sinensis* L.) (Kijalu, 2007)

7.3.1 The Theory

The heat balance method is based on the energy balance of a stem segment to which heat energy supplied by external annular heater. The energy balance of a heated plant stem can be defined as follow (Eq. 1):

$$W = Q_u + Q_d + Q_r + Q_s + Q_f \quad (1)$$

Where W represents the heat energy supplied (W), the heat energy is represented by (Eq. 2):

$$W = I \cdot E_p \quad (2)$$

Where I and E_p are the electric current (I) and voltage (V) supplied to the heater.

Q_u and Q_d are the energies transferred upward and downward, respectively, by thermal conduction along the system. Q_u and Q_d depend on the wood conduction (W) (Eq. 3 and 4).

$$Q_u = \frac{kA_u \cdot (T_{u1} - T_{u2})}{\delta x} \quad (3)$$

$$Q_d = \frac{kA_d \cdot (T_{d1} - T_{d2})}{\delta x} \quad (4)$$

Where k is the thermal conductivity constant of the system sap wood ($W \text{ m}^{-1} \text{ C}^{-1}$), assumed to be $0.5 \text{ W m}^{-1} \text{ C}^{-1}$, A_u and A_d are the cross sectional area of upward and downward, respectively of the heated segment (m^2). $(T_{u1}-T_{u2})$ and $(T_{d1}-T_{d2})$ are difference temperature at the point Δx (m), upward and downward, respectively.

When, the stem is small diameter. This study estimates A_u equal A_d (Eq. 5).

$$Q_u + Q_d = \frac{kA_{ud} \cdot [(T_{u1} - T_{d2}) - (T_{u2} - T_{d1})]}{\delta x} \quad (5)$$

Q_r is the radial heat conduction loss (W), measured by a thermal fluxmeter (Eq. 6).

$$Q_r = \Delta T_r \cdot K_r \quad (6)$$

Where ΔT_r is the radial difference temperature between inside and out site fluxmeter, K_r is the conduction coefficient ($W \text{ } ^\circ C^{-1}$) of the fluxmeter (Eq. 7). K_r is calculated when sap flow is zero.

$$K_r = \frac{W - Q_u - Q_d - Q_s}{\Delta T_r} \quad (7)$$

Q_s is the rate of change in heat storage for the stem segment (Eq. 8).

$$Q_s = \frac{C_w \cdot V \cdot \Delta T_c}{dt} \quad (8)$$

Where C_w is the heat capacity of the wood (2.6 to $3 \text{ MJoule m}^{-3} \text{ } ^\circ C^{-1}$), V is the volume (m^3) of the inside fluxmeter, and $\frac{\Delta T_c}{dt}$ is an estimate of relation center temperature with time ($^\circ C \cdot s^{-1}$). Q_s can be ignored for small stem diameter.

Q_f is the heat energy transported by the mass flow of water (Eq. 9).

$$Q_f = C_p \cdot F \cdot \Delta T \quad (9)$$

$$F = \frac{Q_f}{C_p \Delta T} \quad (10)$$

Where C_p is the capacity of xylem sap, usually taken as the heat capacity of water ($4.186 \text{ j g}^{-1} \text{ } ^\circ C^{-1}$), ΔT is the difference temperature in stem ($^\circ C$) above and below heater. F is the rate of flow of the sap (gs^{-1}) (Eq. 10).

Combining these equations, the following equation calculates for the sap moving up through a cross section per unit time (Eq. 11):

$$F = \frac{(W - Q_u - Q_d - Q_r - Q_s)}{C_p \cdot \Delta T} \quad (11)$$

7.3.2 Sensor Design

Fig. 7.3 shows the sap flow meter designed which contains flexible heater, two pairs of thermocouple to measure temperatures, center thermocouple, thermopile, and insulation.

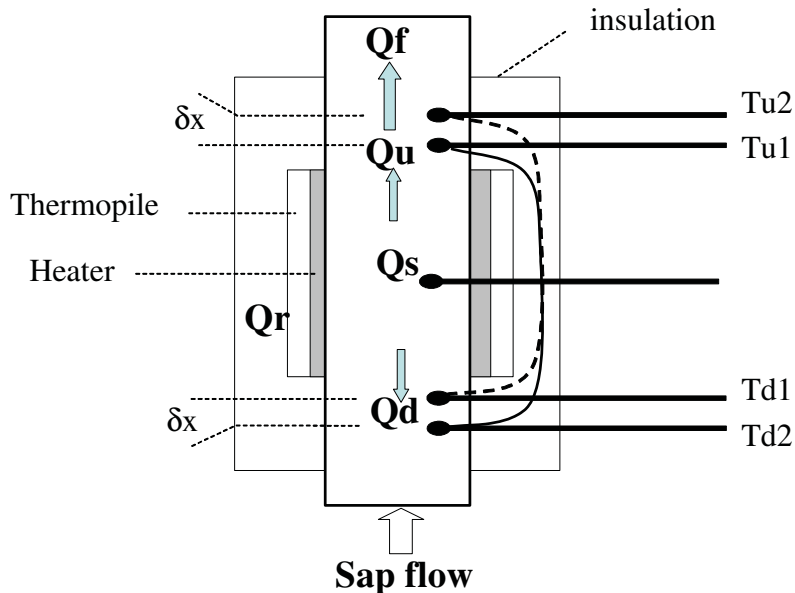

Fig. 7.3 : Sap flow meter designed consists of a flexible heater, two pairs of thermocouple to measure temperatures ($T_{u1}-T_{d2}$) and ($T_{u2}-T_{d1}$), center thermocouple (T_c), thermopile (ΔT_r) and insulation.

Heater

The heat is produced by constantan wire and silicone compound RTV 1556. The width of heater is about 1.5 to 2 fold of the trunk diameter to be study, 2 mm thick and length depends on the perimeter of trunk. The process of flexible heater can be shown as follow:

1. Two rows of nails are taken in wooden frame. The distance between rows of equal length heater and the nails are apart 1 cm. A border of 0.5 cm is rounded the heater to avoid tearing when it is installed.
2. The constantan wire is wound round the equally spaced nails, the upper rows of which are off set from those in the lower row.
3. The silicone compound RTV 1556 is poured in to the wooden frame on a horizontal surface. RTV 1556 is used to support constantan wire.
4. The wooden frame is placed in an oven at 60 °C about 2 hours or at 25 °C 24 hours to obtain reticulation. Heater is removed from the wooden frame.

Temperature sensor

A detector of the differentiation temperatures ($T_{u1}-T_{d2}$) and ($T_{u2}-T_{d1}$) are measured by the pair thermocouple (copper and constantan junction) (Fig. 7.4)

1. Cut 2 copper wires and 1 constantan wire to about 1.5 fold of the length of the heater.
2. Remove about 1 cm of the insulation of copper and constantan wire.
3. Splice copper-constantan-copper should be close to the insulation.
4. Solder the head splice. Then, cut the splice about 0.5 cm.
5. The head splice is enameled by nail varnish.
6. The 2 pair thermocouple mounted on PVC tape.

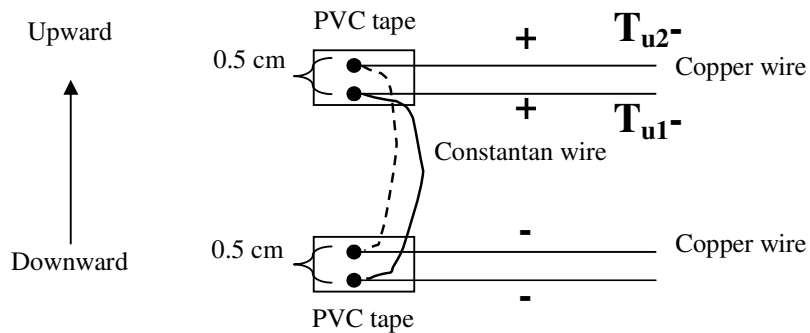

Fig. 7.4 : Detector of the differentiation temperatures ($T_{u1}-T_{d2}$) and ($T_{u2}-T_{d1}$) are measured by the pair thermocouple.

Thermopile

Thermopile detects the radial difference temperature between inside and outside system (ΔT_r). The thermopile consists of silicone sheet and thermocouple series mounted on two faces of silicone sheet (Fig. 7.5).

1. Prepare silicone sheet are same width and increase 1 cm long of heater. The position of three row thermocouple on silicone sheet about 0.25, 0.50 and 0.75 fold of width, 1.5 cm between thermocouple.
2. The thermocouple mounted on silicone sheet by switching crossover from one side to the other side.
3. The thermo-couples are electrically insulated with nail varnish. Then cover the sensor by PVC tape.

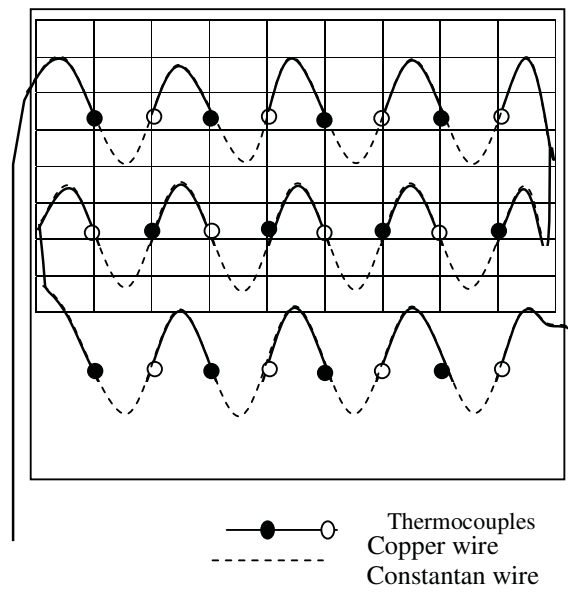

Fig. 7.5 : Thermopile detects the radial difference temperature between inside and outside fluxmeter (ΔT_r).

7.3.3 Sensor Installation

The process of sap flow meter installation starts by marking the position of flexible heater that is two pairs of thermocouple and center thermocouple, on the trunk of plant. The position of thermocouple has to be in line as shown in Fig. 7.3 and the position of center thermocouple is placed in the middle between flexible heater. The first thermocouple upward (T_{u1}) is located above the flexible heater 0.4 cm and the first thermocouple downward (T_{d1}) is located below the flexible heater 0.6 cm. Then, install center thermocouple close to the trunk and cover the trunk by wrapping with the flexible heater, and then wrapping the flexible heater with thermopile. After that, install two pairs of thermocouple at the marked point and then cover all equipment by insulation in order to prevent the loss of heat from inside and the disturbance of the changes of external environment such as temperature and light. The signals from sap flow meter were record data using data loggers (DL2e; Delta-T Devices, Cambridge, U.K.).

7.4 Nitrogen Content Measurement

Nitrogen (N) is the main mineral element in plant tissues. The nitrogen availability commonly limits plant productivity by supporting growth process and increasing quality and quantity of plant. In addition, the nitrogen availability is a necessary to plant as it affects most physiological process of plant development. For examples, the fast growth of poplars (*Populus* spp.) response to fertilization, especially nitrogen availability (van den Driessche *et al.*, 2008; Yin *et al.*, 2009), the changes of nitrogen availability in poplars has an effect on several processes of plant growth such as light-saturated net photosynthesis, water-use efficiency and leaf area, the change to whole-plant architecture, secondary xylem formation, and carbon accumulation (Coleman *et al.*, 2004; Cooke *et al.*, 2005; Pitre *et al.*, 2007; Ripullone *et al.*, 2003; Ripullone *et al.*, 2004). Therefore, nitrogen may play a role of plant growth and development.

Nitrogen content data of this study was collected two times: at the start experiment before bud break, and at the end of experiment when plants produce new shoots. These two stages of data collecting were decided to compare nitrogen uptake before bud break has any effect on the changes of compartment tissues, particularly at the increase of nitrogen content in new shoots. The increase of nitrogen content in new shoots will support the increase of quality and quantity of plant.

Analyzed Nitrogen Content

Tissue samples were placed in liquid nitrogen to stop enzymatic activity and stored at -75 degree Celsius, and waited until freeze-dried at -20 degree Celsius. Then, grounded to fine powder, and then stored at room temperature. The powder was steamed at 60 degree for 2 hours before analyzing to reduce moisture. Then, aliquots of 2-3 mg dry powder materials were weighed into tin cartouches (Hekatech, Wegberg, Germany) and determined by the Elemental analyzer EA1108 (Carlo Erba Strumentazione, Rodano, Milan, Italy). Atropine (4.816 % N; Carlo Erba Strumentazione, Rodano) was used as a standard.

7.5 Estimation Nitrogen Mobilization of Compartment Tissues

Nitrogen mobilization to new growth in spring depends on the amount of internal nitrogen storages that are remobilized. However, the process of remobilization could have a link with the nitrogen availability around the root and nitrogen uptake. When no external nitrogen is available during the re-growth, all nitrogen for new growth comes necessarily from

nitrogen remobilization. However, if plants uptake nitrogen before or during bud break, such part of nitrogen used for new growth could be coming from a newly nitrogen uptake and the other part interferes with storage remobilization. This study wants to test the hypothesis of a dual source with calculation of nitrogen flows inside the system *plant - root environment*. In this model each plant is divided with $p-1$ original compartments (preserving the same structure at the start and the end of experiments) and one more for the new shoots (p) as the new growth. This last compartment takes the value zero ($DW=0$) then new growth is not done. The name of each compartment is other labels with an added subscript as *Start* and *End* for growth studies and *Ref* for the start control.

To start calculation, complete N uptake (N_{up}), biomass of each compartment ($DW_{(n)}$) and their N concentration ($C_{(n)}$) are known for some steps of experiments. Of course, plants involved in growth period cannot be measured at the start experiment then they could show with significant differences of sizes at the start experiment compared to plants of the harvest control (*Ref*). Hypothesis used here assumes that at the start experiment ratio of nitrogen content of a named compartment and total nitrogen content at the plant level is preserved. The objective of calculations is then to evaluate the flow variation of each compartment in case of nitrogen supply or not during bud break as a transition growth period.

By definition, the nitrogen content (N) of one compartment (index n) associates concentration (C) and dry weigh (DW) (Eq.1).

$$N_{(n)} = C_{(n)} \cdot DW_{(n)} \quad (1)$$

The changes in N content (ΔN) of a compartment n (bark, xylem, big root and fine root) during the time of experiment (Δt) is given by the equation of difference (F) (Eq.2)

$$\Delta N_{(n)} = N_{Start(n)} - N_{End(n)} \quad (2)$$

And for variation in percentage that could qualify the change is:

$$\%N_{(n)} = 100 \frac{\Delta N_{(n)}}{N_{Start(n)}}$$

With N_{move} as the variation of the nitrogen content (N) for Δt time at the level of a compartment n , the net flow ($F_{(n)}$) is given by the next equation (Eq.3).

$$F_{(n)} = N_{\text{Start}(n)} - (N_{\text{Start}(n)} + N_{\text{move}}) \quad (3)$$

Positive value of $F_{(n)}$ or N_{move} suggests that the quantity of nitrogen outflow from tissue is more than nitrogen input. In contrast, nitrogen net flow is lesser than zero proposes that nitrogen input is more than the nitrogen output.

Otherwise total nitrogen of the whole plant is the sum of nitrogen contents of all p compartments (Eq. 4).

$$N_{\text{total}} = \sum_1^p N_{(n)} \quad (4)$$

And the ratio ($R_{(n)}$) of the nitrogen content of each compartment and nitrogen content of the whole plant is (Eq.5 with Eq.4 and Eq.1)

$$R_{(n)} = \frac{N_{(n)}}{\sum_1^p N_{(n)}} = \frac{C_{(n)} \cdot DW_{(n)}}{\sum_1^p (C_{(n)} \cdot DW_{(n)})} \quad (5)$$

Hypothesis of preserved properties for plant compartments leads to assign the same value for each compartment of harvested plants at the start of experiment (Ref) and original plants involved in test (Start) (Eq. 6).

$$R_{\text{Ref}(n)} = R_{\text{Start}(n)} \quad (6)$$

During the experiment plants can uptake nitrogen (N_{up}) then that increases their total N content (Eq. 7).

$$N_{\text{End(Tot)}} = \sum_1^p N_{\text{End}(n)} = \sum_1^p N_{\text{Start}(n)} + N_{\text{up}} \quad (7)$$

Ratio (R) of each compartment for nitrogen tissue and total nitrogen of whole plant before bud break is (Eq.8).

$$R_{\text{Start}(n)} = \frac{N_{\text{Start}(n)}}{\sum_1^p N_{\text{End}(n)} - N_{\text{up}}} \quad (8)$$

Using the hypothesis and Equation 6,

$$R_{\text{Ref}(n)} = \frac{N_{\text{Start}(n)}}{\sum_1^p N_{\text{End}(n)} - N_{\text{up}}} \quad (9)$$

Unknown value of N_{start} of each of p compartments can be calculate and is given using Equations 9 and 5.

$$\frac{N_{\text{Start}(n)}}{\sum_1^p (C_{\text{End}(n)} \cdot DW_{\text{End}(n)}) - N_{\text{up}}} = \frac{C_{\text{Ref}(n)} \cdot DW_{\text{Ref}(n)}}{\sum_1^p (C_{\text{Ref}(n)} \cdot DW_{\text{Ref}(n)})} \quad (10)$$

and becomes

$$N_{\text{Start}(n)} = \frac{C_{\text{Ref}(n)} \cdot DW_{\text{Ref}(n)}}{\sum_1^p (C_{\text{Ref}(n)} \cdot DW_{\text{Ref}(n)})} \cdot \left(\sum_1^p (C_{\text{End}(n)} \cdot DW_{\text{End}(n)}) - N_{\text{up}} \right) \quad (11)$$

Net Flow (Eq.3, eq.12) can be calculated with Equation 11 and leads to calculate a relative flow variation at the level of each compartment (Eq.13).

$$F_{(n)} = N_{\text{Start}(n)} - N_{\text{End}(n)} \quad (12)$$

$$\% N_{\text{net_flow}(n)} = 100 \cdot \left(1 - \frac{N_{\text{End}(n)}}{N_{\text{Start}(n)}} \right) \quad (13)$$

N_{Start} can be calculated (Eq. 11) but using Equations 11 and 13, relative variation of the flow can be simplified.

$$\% N_{\text{net_flow}(n)} = 100 \cdot \left(1 - \frac{\sum_1^p (C_{\text{Ref}(n)} \cdot DW_{\text{Ref}(n)})}{C_{\text{Ref}(n)} \cdot DW_{\text{Ref}(n)}} \cdot \frac{C_{\text{End}(n)} \cdot DW_{\text{End}(n)}}{\left(\sum_1^p (C_{\text{End}(i)} \cdot DW_{\text{End}(i)}) - N_{\text{up}} \right)} \right) \quad (14)$$

$$\% N_{\text{net_flow}(n)} = 100 \cdot \left(1 - \frac{N_{\text{End}(n)}}{R_{\text{Ref}(n)}} \cdot \frac{1}{(N_{\text{Tot_End}} - N_{\text{up}})} \right)$$

And with the ration given by Equation 5 that is applied at the end of experiment.

$$\% N_{\text{net_flow}(n)} = 100 \cdot \left(1 - \frac{R_{\text{End}(n)}}{R_{\text{Ref}(n)}} \cdot \frac{N_{\text{Tot_End}}}{(N_{\text{Tot_End}} - N_{\text{up}})} \right) \quad (15)$$

Including Equation 6, formulation shows such as possible the effect of N uptake on an observed compartment (Eq.16).

$$\% N_{\text{net_flow}(n)} = 100 \cdot \left(1 - \frac{R_{\text{End}(n)}}{R_{\text{Start}(n)}} \cdot \frac{N_{\text{Tot_End}}}{(N_{\text{Tot_End}} - N_{\text{up}})} \right) \quad (16)$$

7.6 Non Structure Carbon Content Measurement

Cycles of carbon remobilization and utilization of plants is changed by season. The seasonal patterns of production, accumulation, and utilization of non-structural carbohydrates of deciduous trees are closely correlated with phenological events and/or physiological processes. The non-structure carbon (NSC) is stored in many forms except starch which are the main sources of NSC storage in plants. The NSC also is accumulated on wood and bark in both root and stem via the photosynthesis between summer and autumn. Basically, the NSC is allocated for storage of plant survival, when the current level of carbohydrates produced by photosynthesis is not enough to meet the carbohydrates demand for maintenance and growth or metabolism. Especially, the main reserve carbohydrate stores during winter maintenance respiration and build leaves in spring (Barbaroux *et al.* 2003; Landhausser and Lieffers 2002; Landhausser and Lieffers 2003; Rowe *et al.* 2002; Wong *et al.* 2003). The NSC storage in the root system is considered to be very important for the regeneration and growth of *Pinus taeda*, *Populus tremuloides* (Landhausser and Lieffers 2002; Landhausser and Lieffers 2003; Ludovici *et al.* 2002). Therefore, analyzing of carbon reserve or non-structure carbohydrate (starch, sucrose, and monosaccharide) in every part of plants before and after experiment will reveal the role of carbon reserve on nitrogen uptake on poplars before bud break.

7.6.1 Extraction Non-structure Carbon

Tissue samples were placed in liquid nitrogen to stop enzymatic activity and stored at -75 degree Celsius, and waited until freeze-dried at -20 degree Celsius. Then, grounded to fine powder, and then stored at room temperature. The powder was steamed at 60 degree for 2 hours before analyzing to reduce moisture.

Carbohydrates were extracted from stem and root samples (30-50 mg) of the dry matter with 1.0 ml 80% ethanol at 80°C for 20 minutes, then mixed and centrifuged at 12,000 rpm for 10 minutes.

The supernatant was removed, and the pellet was re-extracted four times, 1.0 ml 80%, 0.5 ml 50% and 0.5 ml 80% two times as above, respectively, and then combined such supernatant. The supernatant and pellet were analyzed to find soluble sugar and starch, respectively (Fig. 6.6).

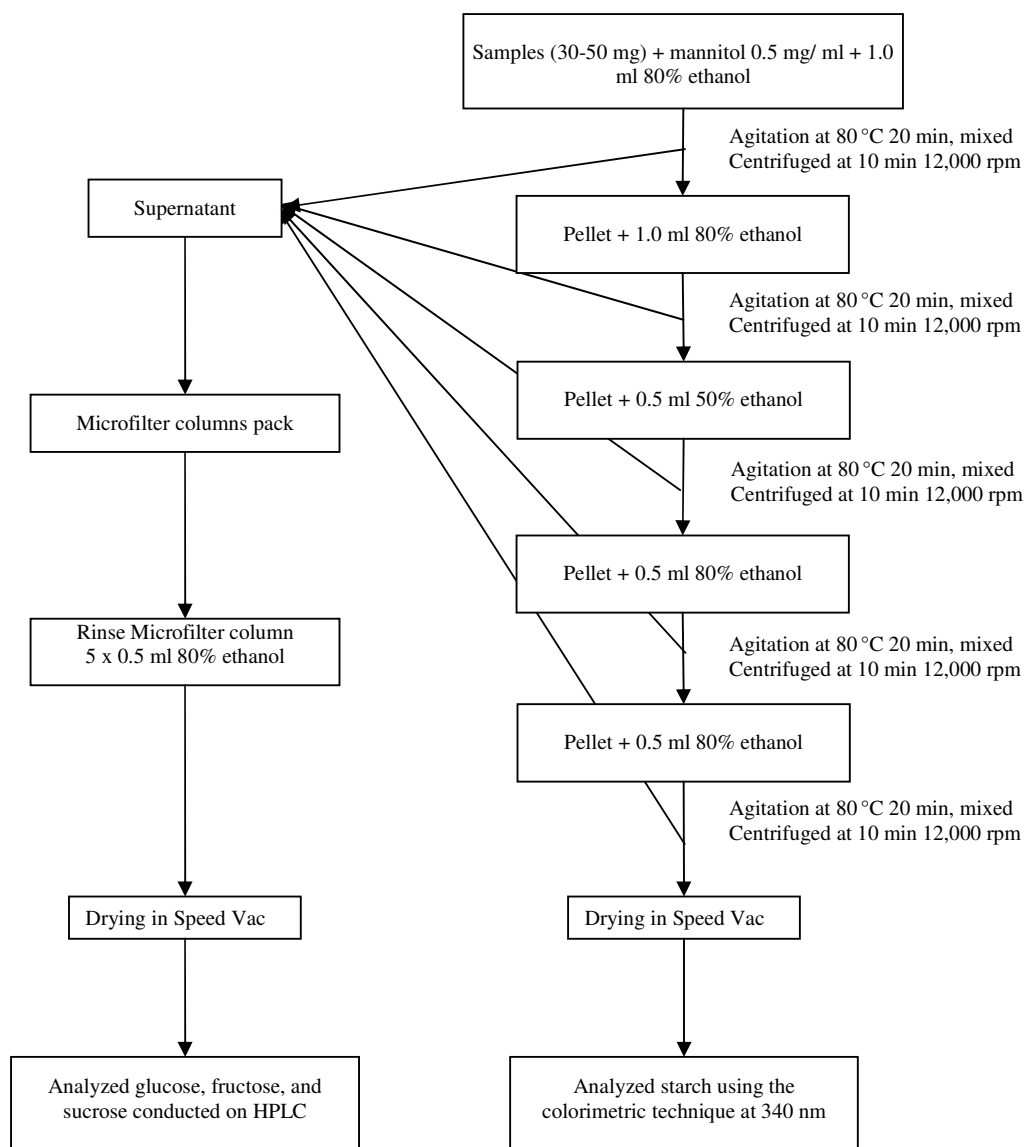

Fig. 7.6 : Protocol Carbohydrates Extraction

7.6.2 Analysis of Glucose, Fructose, and Sucrose

The supernatant purification was filled through microfilter columns pack with 500 μ l activated carbon (Darco[®], power 100 mesh), 100 μ l polyvinylpolypyrrolidone (PVPP), and 150 μ l Resin Bio-Red (AG[®] 1-x8 Rasin) (Fig. 6.7). Then, the sample was dried in speed vacuum. Water 0.5 ml has been filled up before the sample was analyzed. Samples were analyzed for glucose, fructose, and sucrose via the HPLC Metrohm Bioscan system (Metrohm France-91942 Courtaboeuf - France), with Metrosep CARB1 250x4.6 mm column (Metrohm France-91942 Courtaboeuf - France), and pre-column Metrosep CARB1 sucre (Metrohm France-91942 Courtaboeuf - France). The 0.16 N NaOH was used as a solvent at a flow rate of 1.0 ml.min⁻¹ at 32 °C. The detection was done by amperometry.

Individual sugars were identified based on their retention time relative in order to know individual sugar standards. Mannitol was used as an internal standard and it was filled in each sample of the sugar standard during the extraction phase. The evaluation order of different sugars was identified by their retention time and integrated peak area.

For each range of sugar standard was made to construct the curve standards which were built by sugar concentration ($\text{mg}\cdot\text{ml}^{-1}$) = $f(\text{peak area})$. The slopes of straight least squares (a_x) used to evaluate the sugar content of samples. The formula was then used to calculate the content of different sugars shown as follow:

$$[\text{sugar}] = \frac{(PA_x \times a_x)}{M} \times \frac{[\text{mannitol}]_{\text{vial}}}{(PA_{\text{mannitol}} \times a_{\text{mannitol}})}$$

PA_x is the peak area sample of sugar x.

a_x is the slope of the calibration curve of sugar x.

$[\text{mannitol}]_{\text{vial}}$ is the mannitol content ($1 \text{ mg}\cdot\text{ml}^{-1}$). It was filled in the sample during the extraction phase

M is the mass of the test sample

$(PA_{\text{mannitol}} \times a_{\text{mannitol}})$ is the mannitol content ($\text{mg}\cdot\text{ml}^{-1}$) corresponding to the peak area of mannitol the chromatogram.

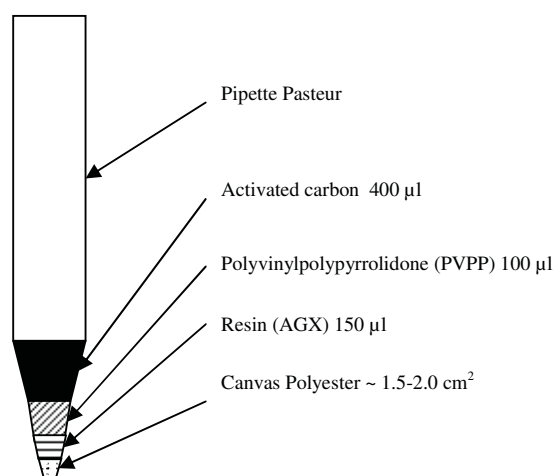

Fig. 7.7 : Microfilter Columns Pack.

7.6.3 Analysis of Starch

Starch was extracted from the pellet that was dried in speed vacuum (Fig. 6.8). The weight of starch was collected (P1), and then added 1 ml of 0.02 N NaOH for 1 hour in an autoclave (120 °C 2 bar) to destroy the cell walls and allow the release starch amyloplasts. Sample was hydrolyzed to glucose with 100 µl of amyloglucosidase (150U/ml) in a 0.32 M citrate buffer (pH 4.2) at 50 °C for 90 minutes. Then, centrifuged the sample for 10 minutes at 10,000 rpm in order to allow sediment the cell debris and then collected its weight (P2).

The glucose analysis was assessed by using of the colorimetric technique at 340 nm (Boehringer, 1984) on a microplate scanning spectrophotometer (Power wave 200 – Bio-tek Instrument, Seralbo Technologie, 94886 Bonneuil sur Marne, France).

Sample of the 12 µl of supernatant or glucose standard 0 g.L⁻¹ - 1.5 g.L⁻¹ with 180 µl of the reaction buffer was taken in micro plate corvette. The first, absorbance was read at 340 nm. (DO₁). Then, started reaction by adding the 10 µl of enzyme Hexokinase-Glucose-6-phosphate dehydrogenase (HK-G6P-DH) (Kunst *et al*, 1984). The incubation was stirred for 40 minutes at 20 °C. The second, absorbance was read at 340 nm. (DO₂). A calibration curve of glucose linear (0 g.L⁻¹ - 1.5 g.L⁻¹) was made to construct the curve standards (concentration mg.ml⁻¹ = $f(\text{DO}_2 - \text{DO}_1)$). The slopes of straight least squares (a_x) were used to evaluate the starch content of samples.

60

Starch contents (expressed as mg g⁻¹ dry matter) were calculated by following equation:

$$[Starch] = \frac{(\Delta DO \times a_x) \times (\Delta P)}{M} \times DF$$

ΔDO is the difference in optical density before and after enzymatic reaction (DO₂ - DO₁).

a_x is the slope of the calibration curve.

ΔP is the difference of volume (P₂ - P₁) of the sample before assay (ml).

M is the mass of the sample (g).

DF is the dilution factor

Principle of Starch Analysis

The starch is hydrolyzed to glucose in the presence enzyme amyloglucosidase at pH 4.2 (Boehringer,1984) as shown in Eq.1.

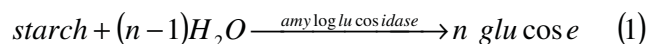

The glucose formed is determined by hexokinase (HK) and glucose-6-phosphate dehydrogenase (G6P-DH) at pH 7.6. Glucose is phosphorylated to glucost-6-phosphate (G-6-P) by adenosine-5'-triphosphate (ATP) in the presence of hexokinase (Eq.2).

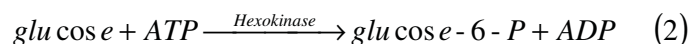

In the presence of enzyme glucose-6-phosphate dehydrogenase, the glucose-6-phosphate is oxidized by nicotinamide-adenine dinucleotide phosphate (NADP⁺) to gluconate-6-phosphate with formation of NADPH reduced (NADH + H⁺) (Eq.3).

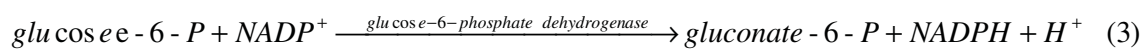

The amount of NADPH from the above reaction is stoichiometric with the amount of glucose. NADPH is measured by absorbance at 340 nm of spectrophotometer. Then, the quantity of starch is used as glucose equivalent.

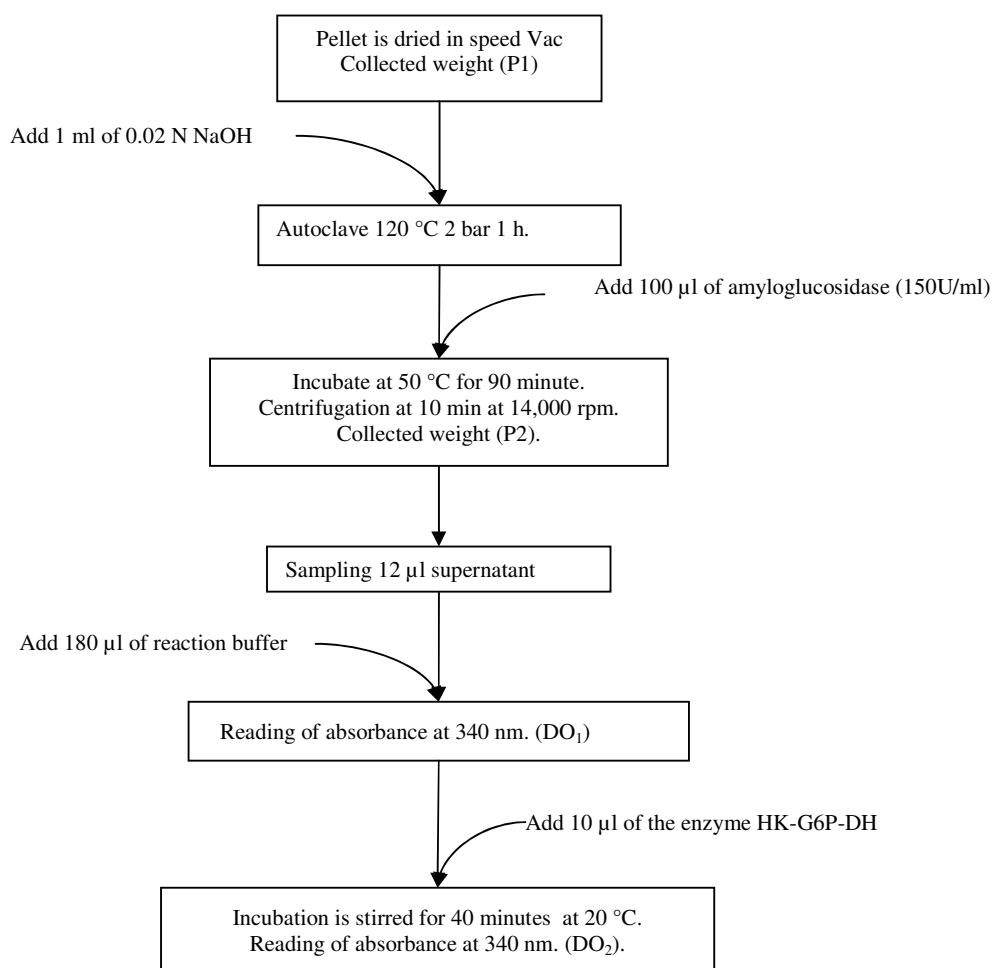

Fig. 7.8 : Protocol Starch Analysis

7.6.4 Preparation Chemical for Analysis Non Structure Carbon Content

7.6.4.1 Solutions

Ethanol 80%; For 1 liter: 800 ml 99% ethanol + 200 ml of ultra pure water.

Ethanol 80% + mannitol (5 g.l⁻¹): For 1 liter; 5 g mannitol in 1 liter of 80% ethanol.

Ethanol 50%; For 1 liter: 500 ml 99% ethanol + 500 ml of ultra pure water.

NaOH 5 N; 200 g NaOH + Fill up to 1 liter of ultra pure water. (The concentration NaOH will keep for several months.)

NaOH 0.02 N; 200 µl 5 N NaOH + 50 ml of ultra pure water.

NaOH 0.16 N; 32 ml 5 N NaOH + Fill up to 1 liter of ultra pure water

7.6.4.2 Microfilter Columns

Activated Carbon

Activated carbon was prepared under the hood 250 ml of activated carbon (Darco G60, Fluka) + 700 ml 80% ethanol. Then, well-shaken and let it stands for 1 hour and removes supernatant. The 700 ml of 80% ethanol was added, shake and let stand for 1 hour and then remove supernatant two times as above. Lastly, add 80% ethanol in the same volume as activated carbon.

PVPP (Polyvinyl Polypyrrolidone)

The PVPP was prepared under the hood 250 ml of PVPP (Sigma) + 700 ml ultra-pure water. Well-shaken and let stand for 1 hour and then removed supernatant. Then, added 700 ml of ultra-pure water, shook and let stand for 1 hour and removed supernatant two times as above. Lastly, added the ultra-pure water in the same volume as the PVPP.

Resin AG® IX8

53 g Na₂CO₃ + 500 ml ultra-pure water (carbonate solution). The four large spatulas resin + 500 ml carbonate solution. Stirred it for 2 hours and then let stand for several hours and aspirated supernatant. After that, added 800 ml of ultra pure water. Let stand for 1 hour and then aspirated supernatant three times as above. Then, rinse the resin with ultra pure water until the pH is in between 6.5 and 7. Then, let stand the complete resin with ultra-pure water at the same volume as resin and store at 4 ° C.

7.6.4.3 Hydrolysis of Starch

Amyloglucosidase (endo-and exo-enzymes)

The 25 mg of amyloglucosidase (750U) + 5 ml of citrate buffer pH 4.2. Amyloglucosidase was prepared 1-2 hours before using. All amyloglucosidas prepared has to be used.

The 0.32 M citrate buffer, pH 4.2; dissolve 4.25 g of citric acid (Prolabo, Normapur) and 3.45 g of Tri-Sodium Citrate (Prolabo, Normapur) in 80 ml of ultrapure water. Adjust pH to 4.2 with NaOH 5N. Fill up to 100 ml with ultrapure water. This buffer is stable for one year when keeps at 4 ° C.

Reaction Buffer for the Determination of Starch

Quantity for a well (a sample):

60 µl buffer triethanolamine

96 µl of ultra pure water

12 µl NADP

12 µl ATP

Triethanolamine Buffer; dissolve 14 g of triethanolamine (Acros Organics) and 0.25 g magnesium sulfate ($\text{SO}_4\text{Mg}\cdot\text{H}_2\text{O}$, Prolabo) in 80 ml of ultrapure water. Adjust the pH to 7.6 with NaOH 5N. Fill up to 100 ml with ultrapure water. This buffer is stable for 4 weeks when keeps at 4 °C.

NADP 11.5 mM; 100 mg of NADP + 10 ml of ultra pure water. This solution is stable for 4 weeks when keeps at 4 °C.

ATP 40.5 M; 250 mg ATP + 250 mg NaHCO_3 + 10 ml ultra pure water. This solution is stable for 4 weeks when keeps at 4 °C.

Hexokinase-Glucose-6-phosphate Dehydrogenase (HK-G6P-DH)

150 µl of Hexokinase (30000U/ml). 60 µl of Glucose-6-phosphate dehydrogenase

(10000U/3ml). Ammonium sulphate buffer 2.79 ml. This enzyme mixture is stable for 1 year when keeps at 4 °C

Ammonium Sulphate Buffer; dissolve 33.035 g of ammonium sulfate $\text{SO}_4 (\text{NH}_4)_2$ with approximately 80 ml ultrapure water. Adjust the pH to 6 with 0.1N or 0.02 N NaOH. Fill up to 100 ml with ultrapure water. This buffer is stable for one year when keeps at 4 °C.

7.7 Estimation Non Structure Carbon Mobilization of Compartment Tissues

Poplar uses sugar reserves during spring activities for a new growth and respiration. This study wants to estimate these consumptions on a short time and in relation to some parameters of the environment. However, it is not possible *in situ* and in real time to analyze specific sugar flows at compartments or whole plant level. Therefore, the possible solution is to build back in first each original part of a target plant at selected time and for each mode of the study. To do that some physical parameters (diameter, length, and biomass) and chemical contents (g/g of sugar) are given and are measured without destruction or after a final harvesting. This approach gives data and some parts of the basis for calculations. Experiments are undertaken with a small duration and two hypotheses need to be done. The first hypothesis is given as the weigh variation of an original compartment comes only from the use or move of the non-structural carbon (NSC) soluble sugars and starch). This means that the structural weigh matter of a defined compartment keeps its dry biomass constant during experiments. Small increase of the structural matter is feasible but is assumed here insignificant. The second hypothesis is given as the sugar content of a plant reference at observed time would be the same that a plant in test if it was involved in the reference design. This approach limits the variations of total sugar valuation coming from variations of plant sizes (physical parameters) and the approach leads to study sugar movements and remobilization with a relative method using equations of difference.

Estimation of Sugar Remobilization from a Compartment

Dry weight of a defined compartment (bark, xylem, big root, and fine root) is the sum of the quantity of sugar as the non-structural carbon and the mass of tissues (S) as the structure of the compartment without sugar (Eq.1). This expression provides the dry weight of the structure (S) as a function of the dry weight of the compartment (DW) and the sugar content (C in g/g) (Eq.2).

$$DW = S + C \cdot DW \quad (1)$$

$$S = DW \cdot (1 - C) \quad (2)$$

The ratio (R) of sugar part and structure of the compartment is given by (Eq.3).

$$R = \frac{C \cdot DW}{(1 - C) \cdot DW} = \frac{C}{1 - C} \quad (3)$$

All these equations can be applied to each compartment and at each time reference. Values are then annotated with subscripts as *Test(n)* with different alias for *Test*,

- *Ref* for reference measured at the beginning experiment,
- *Start* for start experiment but with unknown measures or
- *End* for end of experiment with measurement and
- *n* to index compartment.

In this model, the dry weight of the structure (S) is kept constant during the experiment. Sugar content at the start of experiment is used as the reference content measured (Eq.4 with Eq.2).

$$S_{(n)} = DW_{Start(n)} \cdot (1 - C_{Start(n)}) = DW_{Start(n)} \cdot (1 - C_{Ref(n)}) = DW_{End(n)} \cdot (1 - C_{End(n)}) \quad (4)$$

With Equations 3 and 4 the ratio of start sugar quantity is:

$$R_{Ref(n)} = \frac{C_{Ref(n)} \cdot DW_{Ref(n)}}{(1 - C_{Ref(n)}) \cdot DW_{Ref(n)}} = \frac{C_{Ref(n)}}{1 - C_{Ref(n)}} \quad (5)$$

And with the hypothesis that the ratio R is the same for all plants at the start of the experiment.

$$R_{Ref(n)} = \frac{C_{Start(n)} \cdot DW_{Start(n)}}{(1 - C_{Start(n)}) \cdot DW_{Start(n)}} \quad (6)$$

With Equations 6 and 4,

$$R_{\text{Ref}(n)} = \frac{C_{\text{Start}(n)} \cdot DW_{\text{Start}(n)}}{(1 - C_{\text{End}(n)}) \cdot DW_{\text{End}(n)}} \quad (7)$$

Therefore, with X as the quantity of sugar at the start of experiment, the value that wants to know is:

$$X_{\text{Start}(n)} = C_{\text{Start}(n)} \cdot DW_{\text{Start}(n)} \quad (8)$$

And using Equations 8, 7 and then 5, the quantity of sugar in a compartment n at the start of the experiment is:

$$X_{\text{Start}(n)} = \frac{(1 - C_{\text{End}(n)})}{(1 - C_{\text{Ref}(n)})} \cdot C_{\text{Ref}(n)} \cdot DW_{\text{End}(n)} \quad (9)$$

And the quantity at the end of the experiment is:

$$X_{\text{End}(n)} = C_{\text{End}(n)} \cdot DW_{\text{End}(n)} \quad (10)$$

Equations 9 and 10 lead to calculate the part of remobilization for a compartment as:

$$\% X_{\text{use}(n)} = 100 \cdot \left(1 - \frac{X_{\text{End}(n)}}{X_{\text{Start}(n)}} \right) \quad (11)$$

Or with the values of sugar content known:

$$\% X_{\text{use}(n)} = 100 \cdot \left(1 - \frac{(1 - C_{\text{Ref}(n)}) \cdot C_{\text{End}(n)}}{(1 - C_{\text{End}(n)}) \cdot C_{\text{Ref}(n)}} \right) \quad (12)$$

$$\% X_{\text{use}(n)} = 100 \cdot \left(1 - \frac{R_{\text{End}(n)}}{R_{\text{Ref}(n)}} \right) \quad (13)$$

7.8 Embedding in LR-White Resin and Bud Sections

The axillary buds are in developmental gradient all the time until dormancy. Axillary buds at “youngest” positions will only have initiated bud scales, whereas those in more mature positions will have produced bud scales and foliage leaves (Rohde and Boerjan, 2001). However, the development of axillary buds which locate at the lower part of the trunk may be inhibited by hormone auxin from the upper axillary buds or apical bud. Therefore, axillary buds may have the different development of inside structure during dormancy in winter. For this study, the inside structure of buds of each plant were evaluated before start the experiment during spring and found that the inside structure of buds contains bud scales, small leaves and meristem. This study divides the trunk of plant from below the apex into three parts: top part, from bud number 1-20; middle part, from bud number 21-40; and base, from bud number 41 downward.

7.8.1 Embedding in LR-White Resin

The processes for embedding in LR-White Resin can be explained as follow (Wassim *et al.*, 2009):

Fixation

Buds were cut from plant stem (top, middle, and base) and placed immediately in FAA* on ice and then vacuum in filtrate for 1 hour. Pulled and released in vacuum as slowly as possible. Repeated vacuum infiltration unit tissue sinks, and then placed at 4 °C for 3-5 hours (the amount of tissue should not exceed the one-third of the fixative)

Dehydration

Removed the fixative and filled up with the 50 % ethanol which was pre-cooled to 4 °C. Then, incubated the tissues of top, middle, and base stems for 30 minutes at 4 °C. Replaced the 50% ethanol by the 70%, 80%, 95%, and 100% ethanol solutions, respectively, and then incubated tissues for 30 minutes at 4 °C. In this stage, samples can be kept in 70% ethanol for several days. Lastly, removed 100% ethanol and added fresh 100% ethanol and then incubated overnight in the 100% ethanol solution at 4 °C.

Infiltration

Gradually infiltrated the 100% ethanol by the LR-White resin (LR-White Resin Medium, Sigma) and then incubated at least 15 minutes at 4 °C in the three resins which have different composition. The LR-White and the composition of 100% ethanol used are 1:3, 1:1 and 3:1. Replaced the 3:1 solution by the pure LR-White two times, and then remained the tissues in the pure LR-White for at least 30 minutes at 4 °C to ensure that the ethanol and infiltration are completely removed out of the tissues. Then, incubated such tissues overnight in fresh LR-White resin at 4 °C. After that, placed the tissue samples in an embedding capsule, and then oriented those samples at the bottom position of the capsule. Thus, transverse or tangential longitudinal section can be produced. At this stage, the LR-White was filled up carefully to avoid the introducing of air bubble which will interfere with polymerization. Finally, filled up the capsule with fresh LR-White until it was full, and then closed the lid and polymerised at 55 °C for 15 hours.

7.8.2 Section Bud Sample

Semi-thin sections were made with the Reichert OmU2 microtome. The thickness of semi-thin sections was about 3-4 µm. The semi-thin sections were stained with 0.5 % toluidine blue (Sigma) for 3 minutes, and then washed in distilled water. Stained sections were dried, mounted in Eukitt and examined by Zeiss Axioplan 2 microscope. Data were recorded by using a digital camera (AxioCam HR, Zeiss) with the AxioVision digital imaging software.

7.9 Data Analysis

Data of Experiment I and Experiment II were analyzed as a completely randomized design with the level of nitrogen treatments. Data of Experiment III was analyzed as a randomized block 2×2 factorial design with two levels of nitrogen and two levels of temperature during winter.

All data were subjected to the analysis of variance to determine the significance of difference between treatments. Differences between treatments were assessed by Duncan's multiple-comparison test at the 0.05 level of probability. Mineral uptake of plant was interpreted by using mean. All statistical analyses in this study were performed by using the Statistical Analysis System program (SAS).

Résumé

Dans un sens large, le statut azoté de l'arbre impacte largement sa physiologie au printemps. Cependant la plupart des recherches conduites sur la remobilisation du carbone et de l'azote en cette période ont négligé l'hypothèse d'un rôle significatif de l'absorption d'azote avant le débourrement, en particulier, celui agissant en interaction avec l'utilisation des réserves carbonées et azotées et qui interviendrait dans la qualité de la croissance des jeunes pousses. Cette recherche a été entreprise avec une approche expérimentale et a été conduite avec de jeunes peupliers hybrides (*Populus tremula* × *Populus alba*, clone INRA 717-1B4). Ils ont été utilisés en nombre limité, mais présentaient, par construction initiale, des architectures différentes. Trois séries d'expériences ont ainsi été conduites en trois ans : tout d'abord avec le scion d'un an, puis une petite souche de deux ans et enfin, en associant les deux types de structure, une petite souche portant des réitérations équivalentes au scion d'un an. Les essais ont été conduits en environnement contrôlé et ont fait appel à trois régimes de fertilisation azotée appliquée en solution nutritive recyclée et pendant la transition « repos végétatif et reprise de croissance foliaire » : une fertilisation sans aucun apport en azote (i), un apport d'azote strictement limité à la période amont au débourrement (ii), un apport permanent en azote (iii).

Les résultats montrent que le peuplier peut absorber de l'azote avant le débourrement et que son absorption produit des effets significatifs. Elle conduit en particulier à une forte poussée racinaire qui permet d'augmenter la teneur en eau des tissus caulinaires. Selon les essais, l'effet de l'absorption d'azote avant débourrement et sur le débourrement lui-même dépend de la structure de la plante, de la structure des bourgeons et de la température de conservation hivernale pour le traitement de la dormance. D'autre part, l'application d'azote avant débourrement améliore significativement la croissance des nouvelles pousses en augmentant, avec un temps de croissance identique dans les essais, la surface foliaire et la matière sèche. L'absorption d'azote pendant la transition de croissance maintient en partie la teneur en azote des tissus des plantes et en améliore même la teneur dans les jeunes racines et les jeunes pousses. Elle influence aussi l'utilisation des réserves carbonées. Les résultats de cette étude montrent que l'azote appliqué au printemps et avant débourrement joue un rôle significatif sur la physiologie du jeune arbre et sa reprise de croissance au printemps.

Mots clefs : *Populus*, débourrement, nitrate, absorption minérale, réserves, azote, glucides, poussée racinaire.

Summary

Nitrogen status widely impacts tree physiological process. However, most research concentrated on endogenous carbon and nitrogen remobilization in spring neglected the hypothesis of significant effect of nitrogen uptake before bud break on nitrogen and carbohydrate reserve used, and the quality of new growth. This study undertook experimental-based research on young poplar (*Populus tremula* × *Populus alba*, clone INRA 717-1B4) with different structures. Three series of experiments were conducted in a coordinated manner: the one year old scion (i), the young stump (ii), and the system then reiterated associated the "stump", and the "scion" (iii). The experiments were to study plants in a controlled environment with soilless culture and three terms of nitrogen supply: without nitrogen supply (i), with a limited supply prior to bud break (ii), and with continuous nitrogen supply (iii).

Results show that poplar can uptake nitrate before bud break and it found to have significant effect by induce a strong root pressure which in turn increased water content of all tissues. Accordingly, the effect of nitrogen uptake before bud break on bud break time depended on plant architecture, bud structure, and temperature during winter to break down bud dormancy. In addition, nitrogen uptake before bud break had significantly effect on the growth and development of new shoots after bud break by increase leaf area and dry weight of new shoots. It also influenced on the quantity of nitrogen and non-structural carbon reserves in all tissues especially increase nitrogen contents in roots and new shoots. Therefore, results indicate nitrogen supply before bud break plays a significant role on plant physiology and quality of the re-growth.

Keyword : *Populus*, bud break, nitrate, mineral uptake, nitrogen, sugar, reserves, remobilization, root pressure.