



HAL
open science

Development of theoretical and computational tools for the design of control strategies for nonlinear sampled-data systems

Valentin Tanasa

► **To cite this version:**

Valentin Tanasa. Development of theoretical and computational tools for the design of control strategies for nonlinear sampled-data systems. Other [cond-mat.other]. Université Paris Sud - Paris XI; Universitatea politehnica (Bucarest), 2012. English. NNT : 2012PA112300 . tel-00763971

HAL Id: tel-00763971

<https://theses.hal.science/tel-00763971>

Submitted on 12 Dec 2012

HAL is a multi-disciplinary open access archive for the deposit and dissemination of scientific research documents, whether they are published or not. The documents may come from teaching and research institutions in France or abroad, or from public or private research centers.

L'archive ouverte pluridisciplinaire **HAL**, est destinée au dépôt et à la diffusion de documents scientifiques de niveau recherche, publiés ou non, émanant des établissements d'enseignement et de recherche français ou étrangers, des laboratoires publics ou privés.

UNIVERSITÉ PARIS-SUD
ÉCOLE DOCTORALE : STITS
Laboratoire de Signaux et Systèmes

UNIVERSITÉ POLITEHNICA
DE BUCAREST
Automatic Control and Systems Eng. Dept.

THÈSE DE DOCTORAT

soutenue le 23/11/2012

par

Valentin TANASĂ

Development of theoretical and computational
tools for the design of control strategies for
nonlinear sampled-data systems

Développement d'outils de calcul et de logiciels
pour la réalisation et l'implantation de stratégies
de commande non linéaires échantillonnées

Directeur de thèse :

Co-directeur de thèse :

Dorothee NORMAND-CYROT Directeur de recherche (L2S-CNRS, France)

Dumitru POPESCU

Professeur (Université Politehnica de Bucarest)

Composition du jury :

Président du jury :

Rapporteurs :

Examineurs :

Patrick BOUCHER

Jean-Pierre BARBOT

Vladimir RĂSVAN

Salvatore MONACO

Silviu-Iulian NICULESCU

Cristian OARĂ

Professeur (Supelec, France)

Professeur (ENSEA - ECS, France)

Professeur (Université Craiova, Roumanie)

Professeur (Università La Sapienza, Italie)

Directeur de recherche (L2S-CNRS, France)

Professeur (Université Politehnica de Bucarest)

Tanasă Valentin: *Development of theoretical and computational tools for the design of control strategies for nonlinear sampled-data systems*

Développement d'outils de calcul et de logiciels pour la réalisation et l'implantation de stratégies de commande non linéaires échantillonnées, PhD Thesis , © 23 November 2012

SUPERVISORS:

Dorothee NORMAND-CYROT

Dumitru POPESCU

LOCATION:

Paris

TIME FRAME:

23 November 2012

Dedicated to my beloved Cristina and
to my parents Alexandru and Rodica

*Exposez sans jargon, dans la langue vulgaire et commune à tous, un petit,
nombre de faits qui frappent l'imagination et contentent l'intelligence.
Que votre parole soit naïve, grande et généreuse. Ne vous flattez pas
d'enseigner un grand nombre de choses. Excitez seulement la curiosité.
Contents d'ouvrir les esprits, ne les surchargez point. Mettez-y l'étincelle.
D'eux-mêmes, ils s'éprendront par l'endroit où ils sont inflammables.*

— Anatole France - Jardin d'Épicure

ABSTRACT

This thesis is concerned with the sampled-data control of non-linear continuous-time systems. Sampled-data systems are present in all computer controlled, hybrid or embedded systems. The design and computation of suitable digital controllers represent unavoidable tasks since both continuous and discrete-time components interact.

The basic framework of this work takes part of a wide research activity performed by S. Monaco and D. Normand-Cyrot regarding non-linear sampled-data systems. The underlying idea is to design digital controllers that recover certain continuous-time properties that are usually degraded through sampling as it is the case when continuous-time controllers are implemented by means of zero-order holder devices (emulated control).

This thesis brings contributions into three different directions. The first one, regards theoretical developments: a new digital backstepping-like strategy design for strict-feedback systems is proposed. This method is compared with other strategies proposed in the literature.

The second contribution is the development of a control designer and of a simulation toolbox (in Matlab) for non-linear sampled-data systems. This toolbox includes different digital design strategies such as: multi-rate control, input-output/Lyapunov matching, digital backstepping design, etc.

The third contribution concerns several case studies conducted to highlight the performances of the sampled-data controller designs, computed by the means of the software toolbox. Experimental and simulation results are described for various real examples especially in the area of electrical and mechanical processes.

RÉSUMÉ

Cette thèse concerne la conception de commandes échantillonnées pour les systèmes non-linéaires en temps continu. Les systèmes échantillonnés sont des éléments inhérents aux systèmes contrôlés par ordinateur, les systèmes hybrides ou les systèmes embarqués. La conception et le calcul des contrôleurs numériques appropriés sont des tâches difficiles car ils contiennent des composants à la fois continu et en temps discret.

Ce travail s'inscrit dans une activité de recherche menée par S. Monaco et D. Normand-Cyrot dans le domaine des systèmes échantillonnés non-linéaires. L'idée de base est de concevoir des contrôleurs digitaux qui permettent de récupérer certaines propriétés en temps continu qui sont généralement dégradées par l'échantillonnage. Tel est le cas de l'émulation lorsque les contrôleurs en temps continu sont mis en œuvre en utilisant des bloqueurs d'ordre zéro.

Cette thèse apporte des contributions dans trois directions complémentaires. La première concerne les développements théoriques: une nouvelle conception de type "backstepping digital" est proposée pour les systèmes en forme "strict-feedback". Cette méthode est comparée à d'autres stratégies proposées dans la littérature.

La deuxième contribution est le développement d'un logiciel pour la synthèse des contrôleurs et d'une "boîte à outils" pour simuler (en Matlab) les systèmes échantillonnés non-linéaires et leurs contrôleurs. Cette boîte à outils inclut plusieurs algorithmes pour la synthèse de contrôleurs échantillonnés tels que: commande de type multi-échelle, reproduction entrée-sortie/Lyapunov, backstepping digital, etc.

La troisième contribution concerne plusieurs études de cas menées pour mettre en évidence les performances des contrôleurs échantillonnés, calculés avec l'aide du logiciel. Des résultats expérimentaux et des simulations sont décrits pour divers exemples réels dans les domaines électriques et mécaniques.

REZUMAT

Teza de față se concentrează asupra studiului controlului eșantionat pentru sisteme neliniare în timp continuu. Sistemele eșantionate sunt componente indispensabile oricăror sisteme de control bazate pe dispozitive de calcul, sisteme hibride sau sisteme embedded. Sinteza și calculul comenzilor digitale, potrivite pentru astfel de sisteme, devine o sarcină dificilă o dată ce presupune existența de dinamici în timp discret respectiv în timp continuu.

Cadrul de bază al acestei lucrări se regăsește în activitatea de cercetare realizată de Salvatore Monaco și Dorothee Normand-Cyrot în domeniul sistemelor eșantionate neliniare. Ideea care stă la bază este de a sintetiza comenzile digitale urmărind menținerea unor proprietăți impuse în timp continuu sub eșantionare. Aceste proprietăți sunt în general degradate sub eșantionare cum este cazul comenzilor emulate, când comenzile continue sunt implementate practic cu ajutorul extrapolatoarelor de ordin 0.

Această teză își aduce aportul în 3 direcții complementare. Prima adresează dezvoltările teoretice unde o nouă sinteză de tip backstepping digital este propusă pentru sisteme în formă <strict-feedback>. Această metodă, dezvoltată în două versiuni, este comparată cu alte strategii similare propuse în literatură.

A doua contribuție a tezei este legată de dezvoltarea unui toolbox software pentru sinteza de controllere digitale pentru sisteme nelinare sub eșantionare. Acest toolbox include strategii diferite pentru sinteza eșantionată precum: comandă de tip multi-rate, reproducere intrare-ieșire/Lyapunov, backstepping digital și alte soluții care sunt obiectul unor noi extensii.

A treia contribuție este dată de studiile de caz dezvoltate pentru a scoate în evidență performanțele comenzilor eșantionate testate și calculate cu ajutorul aplicației software. Rezultatele experimentale și de simulare sunt obținute pentru diverse exemple reale din domeniul electric și mecanic.

PUBLICATIONS

CONFERENCE - WITH PEER REVIEW

- [C11] **Tanasa V.**, Monaco S., Normand-Cyrot D. -Digital stabilization of finite sampled nonlinear dynamics with delays: the unicycle example, *13th European Control Conference (ECC)*, Zürich, July 17-19, 2013 (submitted).
- [C10] Monaco S., Normand-Cyrot D. and **Tanasa V.** - Digital stabilization of delayed-input strict-feedforward dynamics, *51th Conference on Decision and Control (CDC)*, Maui, Hawaii, December 10-13, 2012.
- [Co9] **Tanasa V.**, Monaco S., Normand-Cyrot D. - Nonlinear optimal stabilizing control under sampling, *51th Conference on Decision and Control (CDC)*, Maui, Hawaii, December 10-13, 2012.
- [Co8] Hilairet M.,**Tanasa V.**, Bethoux O., Normand-Cyrot D. -A passivity-based controller with charge estimation for coordination of converters in a fuel cell System; experimental results. *8th PPPSC (Power Plant and Power Systems Control) symposium*, Toulouse, France, September 3-5, 2012.
- [Co7] Udrea A., Ticlea A.,**Tanasa V.**, Flutur C. - Necessary conditions for solving the nonlinear MIMO output regulation problem, *20th Mediterranean Conference on Control and Automation*, Barcelona, Spain, 2012.
- [Co6] **Tanasa V.** and Normand-Cyrot D. - "Sur la gestion échantillonnée de l'énergie d'un système - pile à combustible-super condensateurs"- *Septième Conférence Internationale Francophone d'Automatique*, Grenoble, 4-7 July, France, page(s): 727-732, 2012.
- [Co5] **Tanasa V.** and Calofir V. - "A sampled-data level control of nonlinear coupled-tanks"- *AQTR*, May 24-27, Cluj, Romania, 2012, ISBN 978-1-4673-0703-1.
- [Co4] **Tanasa V.** and Normand-Cyrot D. - Experimental digital control of a magnetic suspension. *American Control Conference (ACC)*, Montréal, Canada, pages: 3956-3961, 2012, ISBN 978-1-4577-1094-0.

- [Co3] **Tanasa V.** and Normand-Cyrot D. - "A computer aided software for nonlinear digital control", *Post-proceedings of 13th International Symposium on Symbolic and Numeric Algorithms for Scientific Computing*, Timisoara, page(s): 52-62, 2011, ISBN 978-0-7695-4630-8.
- [Co2] Tiefensee F. and **Tanasa V.** - "Digital implementation of backstepping controllers via input/Lyapunov matching", In: *Proceedings of the 18th IFAC World Congress, Milano*, Vol. 18, page(s): 3421-3426, 2011, ISBN: 978-3-902661-93-7.
- [Co1] **Tanasa V.** and Tiefensee F.- "Un logiciel de commande non linéaire échantillonnée", In: *Proceedings of 6ème Conférence Internationale Francophone d' Automatique, Nancy, France*, 2010.

JOURNAL

- [S1] **Tanasa V.**, Normand-Cyrot D., Monaco S. - "Sampled-data backstepping via Lyapunov matching" , full paper, IEEE TAC (submitted).
- [S2] **Tanasa V.**, Normand-Cyrot D., Popescu D. -" Quantization errors in sampled-data systems with backstepping controllers", UPB Scientific Buletin, Series A(submitted)
- [S3] Udrea A., Ticlea A.,**Tanasa V.**, Flutur C. - "On the nonlinear output regulation problem - Part 1 - MIMO nonlinear systems normal forms and a discussion on the necessary conditions for solving the control problem", UPB Scientific Buletin, Series A, Nr. 4, 2012.

OTHER PAPERS TO BE SUBMITTED

- [P1] **Tanasa V.**, Monaco S., Normand-Cyrot D. - "Multi-rate control design for strict-feedback systems"- Conference paper.

Every man I meet is in some way my superior; and in that I can learn from him.

— Ralph Waldo Emerson - *Think*, Vol. 4-5 (1938)

ACKNOWLEDGMENTS

All the work conducted in this thesis has been possible due to many people that formed, guided, evaluated and helped me. In these lines I want to express my gratitude and my appreciation to all these people.

First of all, I want to give a very warm thank to my PhD advisor Mme Dorothée Normand-Cyrot for all her dedication and enthusiasm while working together all along the PhD period. For me it was always a pleasure and an honor to work with her. I will miss all the days when we were discussing about various aspects in that office from the 5th floor. From my advisor, always a fresh wellspring of ideas, I learned a lot of things, not only theoretical, but also unquantifiable which contributed in shaping me as a promising researcher. All the things I saw and learned have contributed in a irreversible way to my scientific formation.

I want to thank to my PhD second advisor, Prof. Dumitru Popescu for all his support and confidence he showed me since the license years until present days.

I also thank to Prof. Salvatore Monaco for all our discussions, suggestions and all the work made together and for this I always have considered him as co-advisor of my thesis.

I thank Prof. Patrick Boucher for his availability shown to us and for his contributions in all the evaluations we were involved.

I appreciate and thank the reviewers of my thesis: Prof. Vladimir Răsvan and Prof. Jean-Pierre Barbot for their patience and for their valuable suggestions.

The last but not the least, I thank the L2S director Silviu Niculescu, for accepting to be in the jury and also for all his guidance and support since before starting this thesis.

To complete the list, I also thank to my colleagues from L2S and Supelec with whom I shared many research or recreative activities. A special thank to Maryvonne Giron which, among many useful things she had done for me, gave me the first insights into French language.

I want to thank now to my colleagues from Bucharest, especially from the Department of Automatic Control and Systems Engineering which have helped me a lot in the latter years. I am very grateful to Alexandru Ticlea and Andreea Udrea for their effort and for their commitment to propose and gain a research project in my research field, which was essential to my thesis success. I thank also to Catalin

Dimon and to Irina Tache for helping me with all teaching activities and that they took over them all my responsibilities when I was absent. A special thank for Prof. Cristian Oară, for his support and guidance.

I would like to give a special thank to my high school¹ mathematics teacher dr. Anca Andrei. She is the person who contributed essentially in my early scientific developpements by teaching me a high quality mathematics. She dedicated a lot of her time to teach me, even in the after school hours, and so I began to love mathematics and to be competitive. The mathematical background given, along with the informatics skills, developed by the informatics teachers, were so deep that I had no problem in pass the exams at the University and also were essential when choosing my thesis subject.

In the end I want to thank to all my friends that helped me and that supported me in all these years: Ionela Prodan, Raluca & Bogdan Liacu, Florin Stoican, Catalin Tugui, Emanuel Dogaru, Stefan Teodorescu, Roman Socolovschi, Tudor Airimițoaie, Bogdan Ciubotaru, Vasile Calofir (also for our scientific collaborations), etc.

Nothing could be possible without the help of my family and of my beloved Cristina for which I dedicated this work and which were the most affected because of my absence during my stays in France.

Financial support:

- Sectoral Operational Program Human Resources Development 2007-2013 of the Romanian Ministry of Labour, Family and Social Protection through the Financial Agreement POSDRU/88/1.5/S/61178;
- Romanian Ministry of Education, Research, Youth and Sport through UEFISCDI, under grant TE232/2010;
- University Paris Sud 11, Orsay, Program de bourses d'accueil et soutien aux thèses en cotutelle 2010/2011.

¹ <http://www.cni-sv.ro>

CONTENTS

RÉSUMÉ (ÉTENDU) xxvii

- 0.1 Introduction générale xxxii
 - 0.1.1 Commande échantillonnée non linéaire xxxii
 - 0.1.2 Outils de CAO dans le contrôle non linéaire xxxiv
- 0.2 Commande digitale de type “backstepping” via la reproduction entrée/Liapounov xxxvii
 - 0.2.1 L’objectif xxxvii
 - 0.2.2 Backstepping en temps continu- rappels xxxviii
 - 0.2.3 La conception Backstepping échantillonné - avec une échelle de temps xl
 - 0.2.4 Backstepping échantillonné - la conception multi-échelle de temps xlii
 - 0.2.5 Les objectifs et la structure de la boîte a outils xlvii
- 0.3 Contrôle d’une suspension électromagnétique li
- 0.4 Contrôle du niveau de l’eau d’un système des réservoirs couplés lii
- 0.5 Contrôle d’un robot mobile à deux roues lii
- 0.6 Gestion échantillonnée de l’énergie d’un système - pile à combustible-super condensateurs liii
- 0.7 Les effets de l’erreur de quantification dans les systèmes échantillonnés liv
- 0.8 Conclusions générales lvii
 - 0.8.1 Les contributions théoriques lvii
 - 0.8.2 Le logiciel **SimNLSys** lviii
 - 0.8.3 Applications lviii
 - 0.8.4 Conclusion globale lix
- 0.9 Travaux futurs lx
 - 0.9.1 Les développements théoriques lx
 - 0.9.2 Développement du logiciel lxi
 - 0.9.3 Applications lxii

GENERAL INTRODUCTION 1

- 1 GENERAL INTRODUCTION 3
 - 1.1 Nonlinear sampled-data control 3

1.2	CAD tools in nonlinear control	8
1.3	Notations and mathematical aspects	10
1.3.1	The class of systems	10
1.3.2	Vector fields	11
1.3.3	Lie derivative	11
1.3.4	Comparison functions	12
1.3.5	Relative degree	13
1.3.6	Baker Campbell Hausdorff (BCH) exponent	13
1.3.7	Sampled-data systems	14
1.3.8	Example 1.	18
1	THEORETICAL DEVELOPMENTS	23
2	LYAPUNOV STABILITY OF NONLINEAR SYSTEMS	25
2.1	Lyapunov stability in continuous-time	25
2.1.1	The linear case	27
2.2	Lyapunov stability of controlled systems	29
2.3	Lyapunov stability in discrete time	30
2.3.1	The linear case	31
2.4	Lyapunov stability for sampled-data systems	32
2.4.1	The case of the emulation of continuous-time state-feedback controllers	34
2.5	Example 2.	38
3	NONLINEAR INPUT-LYAPUNOV MATCHING UNDER DIGITAL FEEDBACK	41
3.1	The concept of Input-Lyapunov matching	41
3.2	Controller approximation	44
3.3	Example 2- corrective terms	46
3.3.1	First order controller	46
3.3.2	Second order controller	47
3.4	Relative degree higher than 1	50
3.5	MIMO Systems	51
4	DIGITAL BACKSTEPPING CONTROL VIA INPUT/LYAPUNOV MATCHING	55
4.1	The objective	55
4.2	Continuous-time backstepping- one cascade connection case	56
4.2.1	Example 3 (continuous-time design)	59
4.2.2	A constructive solution for the multiple cascade connections	61

4.2.3	Example 4 (continuous-time design)	62
4.3	Sampled-data backstepping under single-rate design	62
4.3.1	Controller computations	64
4.3.2	Example 3 - the sampled-data design	64
4.3.3	Sampled-data solution for the multiple cascade connexions	65
4.3.4	Example 4 - the sampled-data design	65
4.4	Sampled-data multirate control for strict-feedback systems	66
4.4.1	Motivation	67
4.4.2	Multirate sampling of 2nd order	68
4.4.3	Multirate sampling of m-th order	71
4.5	Simulation results	74
4.5.1	Some comments with respect to other similar strategies	83
4.5.2	The strict feedback system with double integrator	92
II SIMNLSYS - SAMPLED-DATA CONTROLLER DESIGN TOOLBOX		99
5	SIMNLSYS SOFTWARE TOOLBOX	101
5.1	The toolbox objectives and structure	101
5.2	The simulation toolbox	104
5.2.1	Simulation of sampled-data systems	104
5.2.2	Sim1 toolbox	106
5.2.3	Simulation scenarios	107
5.2.4	Performance indicators	107
5.2.5	Sim2 toolbox	109
6	CONTROL DESIGN ALGORITHMS	111
6.1	Input/Output and input/Lyapunov matching	111
6.1.1	Single-rate algorithm	112
6.1.2	Algorithms limitations	114
6.1.3	Two and Three-rates algorithms	115
6.1.4	The designer interface	116
6.1.5	Perspectives	117
6.2	Backstepping design	117
6.2.1	Continuous-time design	118
6.2.2	Single-rate algorithm	119
6.2.3	Multi-rate algorithm	119

6.2.4	Perspectives	121
III CASE STUDIES 123		
7	MAGNETIC SUSPENSION CONTROL	125
7.1	Experimental plant description	125
7.2	Mathematical model	126
7.3	Control law design	127
7.3.1	Continuous-time backstepping design	128
7.3.2	Sampled-data backstepping design	129
7.3.3	Symbolic controllers	129
7.4	Simulation Results	130
7.5	Experimental Results	133
8	NONLINEAR COUPLED-TANK - LEVEL CONTROL	143
8.1	The level control problem	143
8.2	Underlying theory	144
8.2.1	Passivity based control	144
8.2.2	Digital design	146
8.3	The experimental plant model and controller design	147
8.3.1	The plant description	147
8.3.2	The dynamics	148
8.3.3	Continuous-time controller design	149
8.3.4	Sampled-data controller design	151
8.4	Results	152
8.4.1	Preliminary result	152
8.4.2	Experimental results	152
9	TWO WHEEL MOBILE ROBOT	159
9.1	Introduction	159
9.1.1	The two-wheeled mobile robot dynamics	159
9.1.2	The discretization issue	160
9.1.3	The non-holonomic integrator	161
9.2	The digital control design for delay free case	161
9.2.1	Piecewise continuous-time controller	162
9.2.2	Controllers implementation	163
9.3	The digital control with delay predictor	164

9.3.1	Simulation results	166
10	FUEL CELL/SUPER-CAPACITOR - ENERGETIC MANAGEMENT	171
10.1	Introduction	171
10.2	System architecture	173
10.2.1	The FC model	174
10.2.2	FC boost converter	174
10.2.3	SCs boost converter	175
10.2.4	DC bus and the load model	175
10.2.5	The complete model	175
10.2.6	Reduced order model	176
10.3	Continuous-time controller design	176
10.3.1	IDA-PBC design	177
10.3.2	Singular Perturbation design	178
10.4	Sampled-data designs	179
10.4.1	IDA-PBC design	179
10.4.2	Singular Perturbation design	189
10.5	Conclusions	190
11	QUANTIZATIONS EFFECTS ON DIGITAL BACKSTEPPING CONTROL	193
11.1	Numerical issues in digital control	193
11.2	Analysis of quantization errors in digital control	194
11.2.1	The linear system case	195
11.2.2	The nonlinear case	196
11.3	Academic example	198
11.3.1	Simulation results	199
11.4	Conclusions	204
	CONCLUSIONS AND FUTURE WORK	207
12	CONCLUSIONS AND FUTURE WORK	209
12.1	Conclusions	209
12.1.1	Theoretical developments	209
12.1.2	The SimNLSys Toolbox	210
12.1.3	Applications	210
12.2	Future work	212
12.2.1	Theoretical developments	212

12.2.2	Software development	213
12.2.3	Applications	214
IV	APPENDIX	215
13	MIMO COMPUTATIONS USED IN CHAPTER 3	217
14	SINGLE AND MULTI-RATE CONTROLLER TERMS COMPUTATIONS	219
14.1	Single-rate controller design	219
14.2	Multi-rate of controller terms computations	221
15	ELECTRICAL AND PHYSICAL PARAMETERS OF THE FC/SCS SYSTEM	223
	References	225

LIST OF FIGURES

Figure 0.1	Le critère de la reproduction du lien entrée/fonction Lyapunov.	xxxviii
Figure 0.2	La fenêtre principale de SimNLSys	xlviii
Figure 0.3	L'architecture du logiciel	xliv
Figure 0.4	Suspension électromagnétique	li
Figure 0.5	Schéma des réservoirs couplés	lii
Figure 0.6	Robot a deux roues	liii
Figure 0.7	L'architecture du système [Ghanes <i>et al.</i> 2011]	liii
Figure 1.1	Sampled data control scheme	14
Figure 1.2	Comparative integration algorithms when computing the sampled-output evolution	21
Figure 3.1	Systems evolutions for different controller approximations	48
Figure 4.1	The input/Lyapunov matching criteria	57
Figure 4.2	States evolutions for proposed algorithms, $\delta = 0.4s$	78
Figure 4.3	Lyapunov evolutions for proposed algorithms, $\delta = 0.4s$	79
Figure 4.4	Simulation results for the proposed algorithms, $\delta = 0.4s$	80
Figure 4.5	Lyapunov error matching results for the proposed algorithms	81
Figure 4.6	Lyapunov difference	82
Figure 4.7	States evolutions for the compared algorithms, $\delta = 0.4s$	86
Figure 4.8	Lyapunov evolutions for compared algorithms, $\delta = 0.4s$	87
Figure 4.9	Simulation results for the compared algorithms, $\delta = 0.4ms$	88
Figure 4.10	Lyapunov error matching results for the compared algorithms (For comparative purposes see Figure 4.5)	89
Figure 4.11	States evolutions for compared algorithms, $\delta = 0.9s$	90
Figure 4.12	Simulation results for the compared algorithms of first order, $\delta = 0.9ms$	91
Figure 4.13	Lyapunov evolutions for proposed algorithms - double integrator, $\delta = 0.4s$	95
Figure 4.14	Simulation results for the proposed algorithms -double integrator, $\delta = 0.4s$	96
Figure 4.15	Lyapunov error matching results for the proposed algorithms - double integrator	97

Figure 5.1	Main window of SimNLSys	102
Figure 5.2	Software diagram	104
Figure 5.3	Main window of Sim1	106
Figure 6.1	IOMatch Module of SimNLSys	112
Figure 6.2	BKS Module of SimNLSys	118
Figure 7.1	Magnetic suspension plant	126
Figure 7.2	Control and V function evolutions for $\delta = 3$ ms (simulation)	131
Figure 7.3	Control and V function evolutions for $\delta = 5$ ms (simulation)	132
Figure 7.4	Control and V function evolutions for $\delta = 7$ ms (simulation)	133
Figure 7.5	Lyapunov matching error under sampled-data control (simulation)	134
Figure 7.6	Simulink control module	135
Figure 7.7	Control, output and Lyapunov for the experimental plant, $\delta = 3$ ms	136
Figure 7.8	Control, output and Lyapunov for the experimental plant, $\delta = 6$ ms	137
Figure 7.9	Control, output and Lyapunov for the experimental plant, $\delta = 7$ ms	138
Figure 7.10	Trajectories evolutions for the experimental plant, $\delta = 3$ ms	139
Figure 7.11	Trajectories evolutions for the experimental plant, $\delta = 6$ ms	140
Figure 7.12	Trajectories evolutions for the experimental plant, $\delta = 7$ ms	141
Figure 7.13	Example for 2 nd order control with $\delta = 0.007$ s	142
Figure 8.1	Schematic of coupled-tanks	147
Figure 8.2	The matching error under sampled-data control	153
Figure 8.3	Experimental results for h_1 , $\delta = 1$ s	154
Figure 8.4	Experimental results for $\delta = 1$ s	155
Figure 8.5	Experimental results for h_1 , $\delta = 10$ s	156
Figure 8.6	Experimental results for $\delta = 10$ s	157
Figure 9.1	Two-wheeled mobile robot	160
Figure 9.2	State and control evolutions	167
Figure 9.3	State and control evolutions	168
Figure 10.1	System architecture[Ghanes <i>et al.</i> 2011]	172
Figure 10.2	Control scheme	173
Figure 10.3	Static characteristic of the FC	174
Figure 10.4	The load profile used	182
Figure 10.5	Simulation results for IDA-PBC	183
Figure 10.6	Simulation results for IDA-PBC	185
Figure 10.7	Simulation results for IDA-PBC	186

Figure 10.8	Simulation results for IDA-PBC	187
Figure 10.9	Simulation results for IDA-PBC	188
Figure 10.10	Simulation results for IDA-PBC	191
Figure 11.1	Lyapunov matching error with quantized controller	200
Figure 11.2	Lyapunov matching error difference between the ideal and quantized controller	201
Figure 11.3	Lyapunov matching error difference between the ideal and quantized controller	202

LIST OF TABLES

Table 1.1	Butcher Tableau	17
Table 1.2	Butcher Tableau DP5	17
Table 1.3	Numerical values of the simulation parameters - Example 1	22
Table 3.1	Numerical values of the simulation parameters- Example 2	49
Table 4.1	Numerical values of the simulation parameters- Example 3 -single and two-rates controllers	76
Table 4.2	Numerical values of the simulation parameters- Example 3 -comparative study	84
Table 4.3	Numerical values of the simulation parameters- Example 4 -single and multi-rate controllers	94
Table 5.1	Sampled-data algorithm	105
Table 7.1	Numerical values of the plant parameters	127
Table 7.2	Stabilizing Time	135
Table 11.1	Numerical values of the simulation parameters- Example 2 with quantization	199
Table 11.2	Errors criteria	203

Table 15.1 Electric characteristics of the hybrid system. 223

ACRONYMS

BCH	Baker Campbell Hausdorf
CADC	Computer Aided Design Control
CTD	Continuous-Time Design
CLF	Control Lyapunov Function
BOZ	Bloqueur d'Ordre Zéro
CAOC	Conception Assistées par Ordinateur de la Commande
CAO	Conception Assistées par Ordinateur
DTD	Discrete-Time Design
GUI	Graphical User Interface
IDA-PBC	Interconnexion and Damping Assignment - Passivity Based Controller
LME	Lyapunov Matching Error
PBC	Passivity Based Controller
MIMO	Multiple Input Multiple Output
RK	Runge-Kutta
SISO	Single Input Single Output
SPT	Singular Perturbation Theory
ZOH	Zero Order Hold
ZSD	Zero State Detectable
SDD	Sampled-Data Design

AUTHOR'S CONTRIBUTION AND ORGANIZATION OF THE THESIS

The thesis is structured into three main parts, as is described below. The contributions of the author are indicated for each chapter concerned.

PART I. THEORETICAL DEVELOPMENTS

In this part, theoretical elements related to the design of sampled-data controller are recalled. A close attention is paid to recalling some basis elements of nonlinear control theory for discrete time and sampled-data systems and some basic mathematical tools.

In [Chapter 3](#) there is described the mathematical framework which is preliminary to the controller designs proposed in [Chapter 4](#). Two new digital designs for systems admitting strict-feedback forms are presented in [Chapter 4](#). Both solutions are based on the concept of the input/Lyapunov matching. The first design concerns a single-rate version, and the second design concerns a multi-rate control scheme. The stabilizing properties of the designs are analyzed through the Lyapunov techniques. The results are extended to systems with multiple cascade connections and illustrated on academic examples. A literature survey is conducted and the performances of similar approaches are recalled and compared with the ones here proposed.

Author's contributions:

- Extension of the input/Lyapunov matching framework in [Chapter 3](#) to the case of MIMO systems and to systems with relative degree higher than 1, respectively. Some aspects concern the paper [Co8] from author's publication list.
- A stability analysis by means of Lyapunov techniques for the proposed sampled-data controllers is discussed in [Chapter 3](#) and [Chapter 4](#) (also in [S1],[P1])
- The design of two new backstepping-type digital controllers: a single-rate version (with F. Tiefensee) ([Co2]) and a multi-rate version respectively ([S1],[P1]).
- The literature survey concerning digital backstepping designs and the performance evaluation of the new controller designs on academic examples are in [Chapter 4](#) and also in [S1].

PART II. SIMNLSYS - SAMPLED-DATA CONTROLLER DESIGN TOOLBOX

In this part is described the **SimNLSys** software application developed in the Matlab environment. Its main goal is to aid the design and computation of sampled-data controllers for nonlinear systems. These designs are carried out for a number of nonlinear strategies such as: LgV control , backstepping control, nonlinear optimal control, passivity based control. This toolbox computes symbolically the expressions of the sampled-data state-feedback controllers.

The software application offers a simulation toolbox, especially dedicated to the analysis of the behavior of sampled-data controllers in terms of the sampling period value and of the order of the controllers' approximations². These simulation tests offer a complete view of these digital design performances compared with that of the continuous-time solution (ideal case) and emulated³ solution.

A discussion about the symbolic algorithms used and tested is given. The limitation and also the benefits of our techniques are revealed.

Many aspects discussed in this part are presented in papers [Co1], [Co3] (from author's publication list 1).

PART III. CASE STUDIES

In this part, 5 case studies are discussed, each one illustrating a distinct advantage or the methodologies behind the proposed digital solutions. The diversity of the applications shows the wide area of the applicability of our approach.

The first case study ([Chapter 7](#)) is about a single-rate version of a backstepping digital design for an eletro-magnetic pendulum system. The obtained results concern simulations and also implementation on an experimental plant available at the Département d'Automatique of Supelec (P. Boucher). The results show a good performance of such strategy compared with the emulated solution. The results are in [Co4] (from Contribution list).

The second case study ([Chapter 8](#)) concerns a digital implementation of a passivity based control for the level control of a coupled-tanks system. The results obtained here are experimental. The results of this work are in [Co5] (from Contribution list).

The third case study ([Chapter 9](#)) concerns the problem of designing digital stabilizing controllers in the presence of delays, when the system has a finite sampled equivalent. This study is conducted on

² The notion of *the order of a controller' approximations* will be introduced in [Chapter 3](#) where an exact digital controller is computed as an infinite series in the sampling period. For practical implementations, a truncation of certain orders of the series is needed

³ "Emulated" stands for continuous-time controllers that are digitally implemented by means of Zero Order Hold (ZOH) devices

a practical example which consists in computing the trajectories of a two-wheeled robot. The study is included in [C11] and some theoretical parts are available in [C10].

The fourth case study ([Chapter 10](#)) presents the digital energetic management of a fuel cell system with super-capacitors. This system is developed for electrical cars. This study proposes two sampled-data controllers, starting from the ones set in the continuous-time domain on the basis of two different nonlinear strategies. This study was part of a larger project supported by the CNRS-INSIS through the project PEPS "Automatique" - GESE - Gestion Echantillonnée des Systèmes Energétiques, 2010. The results reported in this thesis are published in [Co6], [Co8] and it follows to the collaborations with M. Hilairet, O. Bethoux, M. Ghanes and F. Triefensee.

The last case study ([Chapter 11](#)) is analyzing the effects of the quantization error in sampled-data systems with the backstepping controllers proposed in [Chapter 4](#). The analysis is performed on the same academic example developed in [Chapter 4](#) in order to verify the degradation of the stabilizing properties. Part of the work is included in [S2].

OTHER CONTRIBUTIONS

Other works have been performed during the PhD period and have not been included in this thesis due to the exploratory nature of these works, which reflect the directions of interest of the research teams where the author was engaged.

The work carried out in ([Co7],[S3]) represents a first attempt in formulating new conditions for solving the problem of output regulation for the case of Multiple Input Multiple Output (MIMO) systems, which are not necessary square. The future works include also the problem of output regulation in the case of sampled-data systems.

The work ([Co9]) is also a first attempt to the problem of designing digital optimal stabilizing controller for nonlinear sampled-data systems. This work exploits the fact that optimality is linked with passivity, and the previous results obtained by the authors on the passivity and Lyapunov stabilization, under digital control, can be successfully addressed.

RÉSUMÉ (ÉTENDU)

CONTRIBUTION DE L'AUTEUR ET ORGANISATION DE LA THÈSE

La thèse est structurée en trois parties principales, comme décrit ci-dessous. Les contributions de l'auteur sont indiquées pour chaque chapitre concerné.

PREMIÈRE PARTIE. LES DÉVELOPPEMENTS THÉORIQUES

Dans cette partie, des éléments théoriques sont rappelés sur la conception des contrôleurs échantillonnés abordés dans cette thèse. Une attention particulière est portée sur le rappel des éléments de base de la théorie de la commande non linéaire (analyse de stabilité, degré relatif, fonction Lyapunov, etc), sur les systèmes échantillonnés et sur les outils mathématiques utilisés.

Dans le Chapitre 1, on décrit le cadre mathématique qui est préliminaire à la conception des contrôleurs proposée dans le Chapitre 3. Deux nouvelles conceptions digitales sont proposées au Chapitre 4 pour des systèmes admettant une forme "strict-feedback". Les deux solutions sont basées sur l'idée de reproduire la liaison entrée / Lyapunov. La première solution concerne une version avec une seule échelle de temps, et la deuxième solution concerne la conception d'un contrôleur multi-échelles. Les propriétés de stabilisation de ces solutions sont analysées à travers des techniques de Lyapunov. Les résultats sont étendus à des systèmes avec de multiples connexions en cascade et sont illustrés sur des exemples académiques. La littérature est étudiée et les performances d'approches similaires sont rappelées et comparées à celles obtenues ici.

Les contributions de l'auteur :

- l'extension de la méthodologie de reproduction entrée/Lyapunov dans le Chapitre 4 au cas des systèmes MIMO, respectivement au cas des systèmes de degré relatif supérieur à 1⁴. Certains aspects font l'objet de [Co8] dans la liste des publications de l'auteur.
- une analyse de stabilité par des techniques de Lyapunov pour les contrôleurs échantillonnés dans les Chapitres 3, 4 (aussi dans [S1], [P1])
- la synthèse de deux nouveaux contrôleurs digitaux de type "backstepping": une solution avec une échelle de temps ([Co2]) et une solution multi-échelles de temps ([S1],[P1]).
- une étude bibliographique sur contrôleurs digitaux de type "backstepping" et l'évaluation des performances sur des exemples académiques, Chapitre 4 et aussi dans [S1]

⁴ Le concept de degré relatif correspond à la notion d'excès des pôles sur les zéros de la fonction de transfert

DEUXIÈME PARTIE. SIMNLSYS - UN LOGICIEL POUR LA CONCEPTION ÉCHANTILLONNÉE

Dans cette partie est décrit le logiciel **SimNLSys** qui a été développé en Matlab. Le but de ce logiciel est d'aider la conception par ordinateur de contrôleurs échantillonnés pour des systèmes non linéaires. Ces conceptions sont réalisées pour un certain nombre de stratégies non linéaires telles que: le contrôle LgV et le "backstepping", le contrôle optimal non linéaire, le contrôle basé sur la passivité. Le logiciel calcule les expressions symboliques des contrôleurs échantillonnés par retour d'état.

Ce logiciel offre une boîte à outils de simulation dédiée à l'analyse des performances de contrôleurs échantillonnés en fonction de la valeur de la période d'échantillonnage et de l'ordre de l'approximation de la commande⁵. Ces tests de simulation permettent une visualisation comparative des effets de la conception digitale par rapport à la solution en temps continu (le cas de référence) et la solution émulée⁶ au d'autres strategies.

Une discussion sur les algorithmes symboliques utilisés et testés est faite. Les limites et les avantages de nos techniques sont analysés.

De nombreux aspects abordés dans cette partie sont également présentés dans les documents [Co1], [Co3] (dans la liste des publications de l'auteur).

TROISIÈME PARTIE. ÉTUDES DES CAS

Dans cette partie, 5 études de cas sont faites, chacune illustrant un avantage distinct des méthodologies associées aux solutions proposées. La diversité des applications montre le vaste domaine d'applicabilité de notre approche.

La première étude de cas (Chapitre 8) propose une conception "backstepping" digitale, avec une seule échelle de temps, sur une maquette de pendule électromagnétique. Les résultats obtenus incluent la mise en œuvre sur une installation expérimentale disponible au Département d'Automatique de Supélec (Responsable M P. Boucher). Les résultats montrent les bonnes performances de cette stratégie par rapport à la solution émulée. Les résultats sont en [Co4] (de la liste de contribution).

La deuxième étude de cas (Chapitre 9) concerne une implémentation digitale d'une commande basée sur la passivité pour le contrôle de niveau d'un système de réservoirs d'eau. Les résultats expérimentaux sont obtenus à l'Université Politehnica de Bucarest. Les résultats de ce travail sont en [Co5] (de la liste de contribution).

⁵ Le terme *ordre d'approximation d'un contrôleur* sera introduit au Chapitre 3 où un contrôleur numérique exact est calculé comme une série infinie paramétrisée par la période d'échantillonnage. Pour les applications pratiques, une approximation polynomiale à un ordre fini de la série est judicieuse.

⁶ Dans cette thèse le terme "Émulé" désigne l'implantation d'une loi de commande conçue en temps continu par bloqueur d'ordre zéro - BOZ

La troisième étude de cas (Chapitre 10) concerne la conception de contrôleurs digitaux stabilisant en présence de retards, lorsque le système a un équivalent échantillonné calculable exactement. Cette étude est menée sur l'exemple d'un robot mobile à deux roues. L'étude est incluse dans [C11] et certaines parties théoriques sont disponibles dans [C10].

La quatrième étude de cas (Chapitre 11) présente la gestion échantillonnée énergétique d'un système de pile à combustible avec des super-condensateurs. Ce dispositif est développé pour des voitures électriques. Cette étude propose deux contrôleurs échantillonnés à partir de ceux définis dans le domaine continu sur la base des deux stratégies différentes non linéaires. Cette étude fait partie d'un projet soutenu par le CNRS-INSIS dans le cadre du PEPS "Automatique" - GESE - Gestion Échantillonnée des Systèmes Énergétiques, 2010/2011. Les résultats présentés dans cette thèse sont en [Co6], [Co8]

La dernière étude de cas (Chapitre 12) se consacre aux effets de l'erreur de quantification pour des systèmes échantillonnés avec des contrôleurs "backstepping" proposés au Chapitre 4. L'analyse est effectuée sur le même exemple académique développé au Chapitre 4 afin de vérifier la dégradation possible des propriétés de stabilisation. Une partie du travail est incluse dans [S2].

AUTRES CONTRIBUTIONS

D'autres travaux non inclus ont été effectués pendant la période de doctorat.

Il s'agit des travaux menés en ([Co7],[S3]) qui constituent une première tentative pour formuler de nouvelles conditions pour la régulation de sortie pour de systèmes MIMO, qui ne sont pas nécessairement carrés (en nombre d'entrées et de sorties). Les travaux futurs incluent la régulation de sortie dans le cas de systèmes échantillonnés.

Le travail ([Co9]) est également une première tentative pour la conception d'un contrôleur digital optimal et stabilisant pour des systèmes échantillonnés non linéaires. Ce travail exploite le fait que l'optimalité peut être liée à la passivité et les résultats obtenus précédemment par les auteurs sur la passivité.

0.1 INTRODUCTION GÉNÉRALE

0.1.1 *Commande échantillonnée non linéaire*

Le développement croissant, au cours des dernières décades, des moyens de calcul très puissants a conduit, parmi d'autres bénéfiques, à un développement significatif en termes de performance des systèmes de commande. Par conséquent, l'implémentation rigoureuse des systèmes de commande peut contribuer à la croissance économique et la qualité de vie.

Cette thèse s'intéresse à la conception de commandes échantillonnées pour les systèmes non linéaires. Les systèmes échantillonnés sont des éléments inhérents des systèmes contrôlés par ordinateur, des systèmes hybrides ou des systèmes embarqués. La conception et le calcul des contrôleurs numériques appropriés représente une tâche difficile car ils contiennent des éléments à la fois continu (décrit par des fonctions non linéaires) et temps discret.

Les solutions proposées dans cette thèse s'appuient sur les travaux de professeurs Dorothée Normand-Cyrot et Salvatore Monaco [Monaco & Normand-Cyrot 1984c], [Fromion *et al.* 1996], [Monaco & Normand-Cyrot 2001], [Monaco *et al.* 2007], [Monaco & Normand-Cyrot 2009], [Monaco *et al.* 2011]. L'idée de base est d'identifier certaines propriétés du système non linéaire continu et de proposer des méthodes numériques pour les préserver à chaque instant d'échantillonnage. Cette méthode permet de transférer des techniques validées en théorie sur des systèmes en pratique.

La synthèse de contrôleurs stabilisants pour des systèmes non linéaires échantillonnés pose deux problèmes difficiles: l'un est lié à la structure non linéaire, l'autre concerne la prise en compte des aspects numériques inévitables dans les applications temps réel.

L'intérêt pour le contrôle non linéaire est croissant, car plus réalisable en pratique que le linéaire plutôt que linéaire [Isidori 1995], [Khalil 1996], [Rasvan & Stefan 2007], [Boucher & Dumur 2006]. En fait, de nombreuses solutions pratiques reposent sur la linéarisation ou l'approximation du modèle réel et par conséquent des dynamiques fondamentales sont négligées.

Un système échantillonné est un système qui fonctionne en temps continu avec certains de ses signaux d'entrée et de sortie (capteurs, actionneurs) sont échantillonnés à des instants différents. Ce type de comportement appelé aussi "hybride", car ils appartiennent au contexte des systèmes embarqués. [Hanselmann 1987], [Chen & Francis 1995], [Astrom & Wittenmark 2011].

Le contrôleur numérique doit offrir une reconstruction du signal continu compatible avec l'entrée du processus. Plusieurs questions importantes concernant l'échantillonnage, la quantification et la reconstruction du signal doivent être abordées [Liberzon 2001, Liberzon 2006], [De Persis 2005]. L'objectif

étant de concevoir un contrôleur numérique qui satisfasse aux exigences souhaitées et accomplies par un schéma idéal continu. Dans la littérature, différentes approches existent et sont résumées ci-dessous.

- A. **Conception en temps continu** - Le contrôleur est conçu en temps continu et il est implanté en temps discret. Généralement la mise en œuvre en temps discret d'un système en temps continu est réalisée au moyen des dispositifs d'échantillonnage et de blocage, tels que le module Bloqueur d'Ordre Zéro (BOZ). Le BOZ- échantillonne le signal en temps continu avec une période d'échantillonnage fixe et produit une sortie constante pendant ce temps. Dans ce cas, nous parlons de *l'émulation* d'un contrôleur en temps continu, ce qui représente la stratégie la plus courante lors d'applications d'un contrôleur continu sous échantillonnage. L'inconvénient majeur est que les performances du contrôleur conçu en temps continu ne sont pas maintenues [Halanay & Răsvan 1977], [Monaco *et al.* 1986], [Monaco & Normand-Cyrot 1986]. D'autres types de bloquer d'ordre supérieur à échelles de temps multiples sont introduits pour permettre de meilleurs performances [Di Giamberardino *et al.* 1996a], [Djemai *et al.* 1999], [Hu & Michel 1999].
- B. **Conception en temps discret** - La conception de la commande est réalisée sur le modèle équivalent en temps discret du processus en temps continu. Dans ce cas, la conception néglige le comportement entre les instants d'échantillonnage qui peut être critique. Si dans un contexte linéaire cette méthode reste valide, dans le cas non linéaire le calcul exact de modèles équivalent en temps discret deviennent insoluble. Un autre inconvénient est que, suite à la procédure d'échantillonnage, les propriétés vérifiées en temps continu sont généralement perdues. Si l'on suppose qu'il existe un équivalent échantillonné du système en temps continu, des progrès notables ont été fait pour la conception de contrôleurs discrets pour les systèmes non-linéaires [Monaco & Normand-Cyrot 2007]. Si un modèle exact n'est pas disponible un modèle échantillonné approché peut être utilisé pour la conception de contrôleurs. Le plus couramment utilisé est le modèle d'Euler, approximation au premier ordre.
- C. **Conception échantillonnée** - Dans ce cas, la commande numérique est conçue à partir du modèle échantillonné équivalent du processus en temps continu, décrit par une fonctionnelle dépendant de la période d'échantillonnage. De cette façon, on peut tenir compte du comportement entre les instants d'échantillonnage. Le modèle échantillonné vérifie des propriétés spécifiques qui sont des propriétés du système continu. Les contrôleurs sont aussi décrits par leur développement asymptotique en fonction de la période d'échantillonnage.

L'avantage majeur de cette approche, par rapport aux conceptions en temps continu ou en temps discret, est de permettre l'objectif de reproduction des propriétés en temps continu aux instants

d'échantillonnage [Monaco & Normand-Cyrot 2009]. Deux scénarios sont possibles pour la conception. Le premier scénario, que l'on appelle *conception indirecte* utilise une solution en temps continu conçue "a priori" avec certaines performances. Le deuxième scénario, appelé *conception directe* ne suppose pas l'existence d'une solution continue. Un contrôleur numérique est conçu, à partir du modèle échantillonné, en imposant des objectifs de performance discrets.

Une question peut être posée aujourd'hui: dans le mesure où l'acquisition et les dispositifs d'échantillonnage fonctionnent à des périodes d'échantillonnage très petites, pourquoi développer des méthodes échantillonnées spécifiques ? Trois contre-arguments peuvent être observés. Tout d'abord si un échantillonnage rapide permet une récupération plus précise des mesures, les erreurs de quantification et de bruits induisent des effets néfastes. Deuxièmement, comme il a été souligné précédemment, il existe des situations où des solutions en temps continu n'existent pas, et la seule solution est de proposer une conception échantillonnée. Troisièmement, ces techniques fonctionnent mieux même à période d'échantillonnage assez petite.

Le but de ce travail est de développer des outils de calcul dédiés à la conception et au calcul des contrôleurs numériques ainsi qu'un logiciel.

0.1.2 Outils de CAO dans le contrôle non linéaire

L'utilisation massive de calcul symbolique dans les deux dernières décennies a suscité le développement d'outils logiciels pour la conception et l'analyse des systèmes de contrôle. En intégrant algorithmes numériques et caractéristiques de l'interface graphique, de nombreuses boîtes à outils pour la Conception Assistées par Ordinateur de la Commande (CAOC) ont été développées [Ahmad *et al.* 1992], [Samaan *et al.* 1989], [Gasparyan 2006]. Ces logiciels se révèlent utiles dans les activités d'enseignement, de recherche ou même industrielles afin d'éviter des manipulations algébriques complexes/numériques et faciliter le transfert technologiques.

Dans le domaine du contrôle, ces logiciels CAOC sont spécifiques des dynamique du système et du type de stratégie de commande. Ces "boîtes à outils" sont largement développées pour le cas linéaire et la plupart utilise des algorithmes numériques. Ces logiciels couvrent une variété de stratégies telles que: optimale, robuste, adaptative, commande prédictive, etc. En ce qui concerne les aspects informatiques, le principal avantage de la dynamique linéaire est liée à l'utilisation du calcul matriciel. Dans le contexte non linéaire, la situation est très différente, car la non linéarité implique la composition de fonctions et d'opérateurs au lieu d'opérations matricielles comme opération élémentaire.

Pour l'analyse et la conception de commande des systèmes non linéaires, la géométrie différentielle fournit un cadre mathématique utile. Les objets différentiels géométriques (dérivée et crochet de Lie) peuvent être traités avec des outils symboliques. De cette façon, les solutions aux problèmes de contrôle non linéaire peuvent être calculées exactement sans accumulation de l'erreur de quantification comme c'est souvent le cas avec les algorithmes de conception numérique.

Le logiciel développé dans cette thèse fait référence à la stratégie de commande de reproduction d'entrée-sortie proposée dans [Monaco & Normand-Cyrot 2007] et développée dans [Monaco *et al.* 2011], [Monaco & Normand-Cyrot 2009]. L'efficacité de ces techniques, validée grâce à la simulation d'exemples académiques réalistes ou sur des exemples réels, justifie la nécessité de développer un logiciel ad hoc. L'idée de base est la suivante:

L'hypothèse suppose que sont donnés : un système à temps continu décrit par des équations différentielles ordinaires et éventuellement un contrôleur en temps continu conçu pour satisfaire certains objectifs de contrôle. En supposant que la commande est maintenue constante sur des intervalles de temps de longueur constante, le problème est de trouver une loi numérique, de telle sorte que les performances du système soient identiques aux performances dites idéal (stratégie en temps continu). Cette coïncidence est demandée à chaque instant d'échantillonnage. On parle ici de reproduction entrée-sortie sous contrôle constant par morceaux. Les solutions proposées font référence aux développements en séries de Lie et au calcul combinatoire. Le caractère combinatoire et itératif des solutions suggère le développement d'un logiciel ad hoc qui fait appel à des outils de calcul formel.

Dans cette thèse, l'attention ne se limite pas aux systèmes Single Input Single Output (SISO), mais également aux systèmes MIMO. L'existence des solutions repose sur la notion de degré relatif (extension au cas non linéaire de l'excès de pôles sur les zéros dans le cadre linéaire). La liaison entrée/sortie peut être comprise comme le lien cible privilégié devant être contrôlé. En fait si l'on considère la conception de type Lyapunov, le lien privilégié à contrôler est le lien entrée/Lyapunov. Dans le contexte d'optimalité, un tel lien privilégié correspond au lien entrée/critère associé à une fonction d'énergie ou à une autre critère.

Le logiciel complet comprendra différents modules fournissant des versions échantillonnées du "backstepping", de l'optimalité ou des techniques basées sur les propriétés de passivité convenablement définies pour des liens entrée/sortie.

En ce qui concerne les applications du CAOC pour les systèmes échantillonnés, il existe des outils développés pour les dynamiques linéaires. À la connaissance de l'auteur, il n'existe pas d'outil de Conception Assistées par Ordinateur (CAO) pour des systèmes non linéaires échantillonnés comparable à SimNLSys.

PREMIÈRE PARTIE. LES DÉVELOPPEMENTS THÉORIQUES

0.2 COMMANDE DIGITALE DE TYPE “BACKSTEPPING” VIA LA REPRODUCTION ENTRÉE/LIAPUNOV

0.2.1 L’objectif

La méthode du “backstepping” est aujourd’hui une stratégie de conception de commande stabilisante très utilisée dans le cas des systèmes non linéaires qui vérifient une structure particulière de type *strict-feedback* (voir les équations (0.1)-(0.2)). La difficulté réside dans l’existence d’un degré relatif supérieur à 1, qui représente un obstacle pour la conception de commandes reposant sur la passivité Passivity Based Controller (PBC). La méthode “backstepping” permet de remédier cet obstacle.

La procédure “backstepping”, dans sa formulation globale, donne les ingrédients pour calculer des contrôleurs qui stabilisent l’origine globalement. Bien que cette méthode puisse se comparer à la linéarisation dynamique, sa particularité est de prendre en compte la non linéarité qui est utile pour la stabilité. Le principal inconvénient de cette procédure est le nombre de connexions en cascade de la structure strict-feedback et le fait que les expressions du contrôleur deviennent plus complexes. Pour faire face à cela, certaines procédures sont proposées, qui permettent d’atteindre des résultats semi-globaux comme la conception grand gain ou “backstepping” semi-global [Sepulchre *et al.* 1997].

Comme cette procédure a un impact majeur dans nombreuses applications en temps réel, le problème de la conception de contrôleurs constants par morceaux qui permettent de préserver les propriétés du contrôleur en temps continu doit être résolu. Tel est l’objectif de ce chapitre.

Dans cette thèse, deux stratégies sont proposées en utilisant les critères visant à reproduire le lien entrée/Lyapunov. Ce critère, utile pour obtenir de meilleures performances de stabilisation par rapport à l’émulation classique des contrôleurs en temps continu, semble être approprié, dans le contexte de “backstepping”.

Une première approche consiste à concevoir une loi de commande échantillonnée u_k de sorte que l’évolution de la fonction de Lyapunov V définie pour une connexion en cascade en temps continu soit reproduite à chaque instant d’échantillonnage. Il s’ensuit que, les performances de stabilisation du contrôleur en temps continu sont préservées aux instants d’échantillonnage.

La Figure 0.1 décrit le problème.

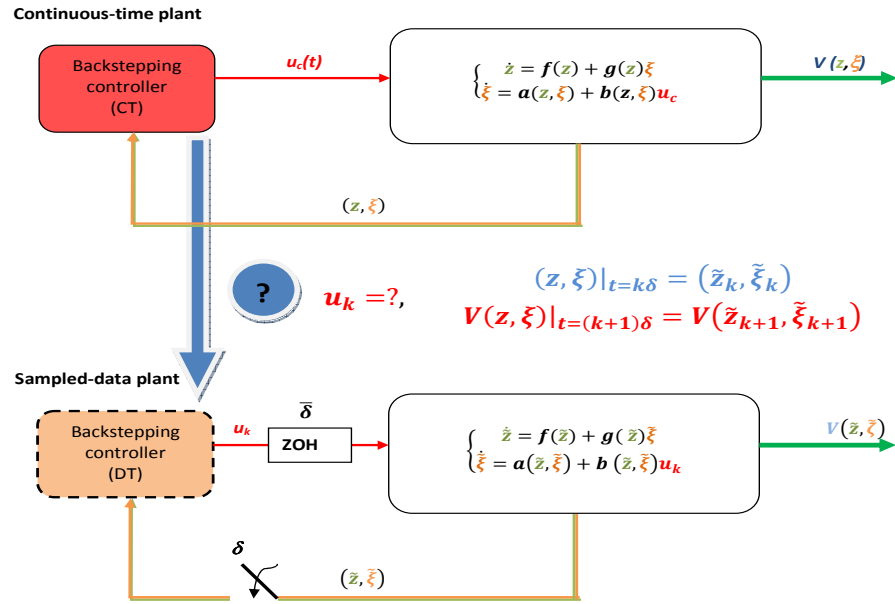

Figure 0.1: Le critère de la reproduction du lien entrée/fonction Lyapunov.

En haut de la figure, le système avec un contrôleur en temps continu est représenté. L'évolution de la fonction de Lyapunov V , exprimée en termes de variables d'états du système, représente la caractéristique de stabilisation du système en boucle fermée avec un contrôleur "backstepping" en temps continu. Dans le bas de la figure, un contrôleur échantillonné est appliqué sur le même système avec l'aide des dispositifs d'échantillonnage. Ici δ représente la période d'échantillonnage et $\bar{\delta}$ est le temps d'application (tenue) du contrôleur qui peut être égal à une fraction de δ , $\bar{\delta} = \delta/m$.

Une seconde tentative, qui fait référence à une conception multi-échelles de temps, impose des objectifs supplémentaires, afin d'améliorer les propriétés de stabilisation (dynamique des zéros, inter échantillonnage).

0.2.2 Backstepping en temps continu- rappels

On considère des systèmes dans la forme *strict-feedback* suivante (avec une seule cascade):

$$\dot{z}(t) = f(z(t)) + g(z(t))\xi(t) \quad (0.1)$$

$$\dot{\xi}(t) = a(z(t), \xi(t)) + b(z(t), \xi(t))u_c(t) \quad (0.2)$$

où les états z et ξ évoluent respectivement dans \mathbb{R}^n et \mathbb{R} , l'entrée commandée $u_c \in \mathbb{R}$, et les champs de vecteurs f, g et $a(\cdot), b(\cdot)$ dans \mathbb{R}^n et respectivement dans \mathbb{R} sont complets et analytiques.

Le résultat suivant décrit une loi de commande en temps continu qui stabilise asymptotiquement l'origine du système (0.1)-(0.2).

Theorem 1. [Krstic et al. 1992],[Khalil 1996] - *Backstepping en temps continu* - Soit le système (0.1)-(0.2), on suppose l'existence d'une fonction $\phi(z)$ avec $\phi(0) = 0$ et d'une fonction de Lyapunov $W(z)$, radialement non bornée, telles que

$$\frac{\partial W}{\partial z}(f(z) + g(z)\phi(z)) < 0, \forall z \in \mathbb{R}^n / \{0\}. \quad (0.3)$$

Si l'existence de $b^{-1}(z, \xi)$ est garantie pour tout (z, ξ) , la commande par retour d'état

$$u_c = b(z, \xi)^{-1} \left(\dot{\phi} - \frac{\partial W}{\partial z} g(z) - a(z, \xi) - K_y (\xi - \phi) \right) \quad (0.4)$$

avec $\dot{\phi} = \frac{\partial \phi}{\partial z}(f(z) + g(z)\xi)$ et $K_y > 0$ stabilise globalement et asymptotiquement l'origine de (0.1)-(0.2), avec

$$V(z, \xi) = W(z) + \frac{1}{2}(\xi - \phi(z))^2 \quad (0.5)$$

comme fonction de Lyapunov.

Certains commentaires sont utiles: le contrôleur u_c réalise deux objectifs: il rend le lien $v \rightarrow y := \xi - \phi(z)$ passif et il améliore l'amortissement grâce au retour de sortie avec un gain négatif $-K_y$. De plus, en substituant $\xi = \phi$ par $\xi = \phi + v_0$, la condition (0.3) garantit la passivité du lien $v_0 \rightarrow y_0$, avec

$$y_0^T := \frac{\partial W}{\partial z} g(z)$$

et la fonction de stockage W .

En posant $u_c(t) = u_k$ (constante sur un intervalle), la négativité de \dot{V} , entre les instants d'échantillonnage, n'est plus assurée comme il est expliqué dans [Tiefensee et al. 2009]. Par conséquent, l'échantillonnage peut détruire les propriétés de stabilisation fixées en temps continu. Plusieurs stratégies échantillonnées peuvent alors être proposées.

0.2.2.1 Une solution constructive pour plusieurs connexions en cascade

Le résultat précédent de la Theorem 1 est généralisé au système strict-feedback avec plus d'une connexion en cascade.

$$\begin{aligned} \dot{z}(t) &= f(z(t)) + g(z(t))\xi_1(t) \\ \dot{\xi}_1(t) &= a_1(z(t), \xi_1(t)) + b_1(z(t), \xi_1(t))\xi_2(t) \\ &\vdots \\ \dot{\xi}_{m-1}(t) &= a_{m-1}(z(t), \xi_1(t), \dots, \xi_{m-1}(t)) + b_{m-1}(z(t), \xi_1(t), \dots, \xi_{m-1}(t))\xi_m(t) \\ \dot{\xi}_m(t) &= a_m(z(t), \xi_1(t), \dots, \xi_m(t)) + b_m(z(t), \xi_1(t), \dots, \xi_m(t))u(t) \end{aligned} \quad (0.6)$$

avec les états $z \in \mathbb{R}^n$ et $\xi_i \in \mathbb{R}$, toutes les fonctions sont considérées au moins de classe C^1 et tous les $b_i(\cdot)$ sont supposés inversibles $\forall (z, \xi_1, \dots, \xi_m)$.

Dans un premier temps, nous prendrons la sortie virtuelle comme $y_1 = \xi_1 - \alpha_1(z)$, alors le système a un degré relatif $m + 1$ liée à cette sortie. D'une manière récursive, en suivant la procédure "backstepping", pour chaque étape une nouvelle sortie virtuelle y_i est définie comme $y_i = \xi_i - \alpha_i(z, \xi_1, \dots, \xi_{i-1})$ avec un contrôleur fictif α_i tel que chaque fonction de Lyapunov

$$V_i = W + \frac{1}{2} \left(\sum_{j=1}^{i-1} y_j^2 \right) \quad (0.7)$$

assure les propriétés de stabilité des premières i connexions. Chaque α_i peut être construit comme:

$$\alpha_i = \frac{1}{b_{i-1}(\cdot)} \left(\dot{\alpha}_{i-1}(\cdot) - \alpha_{i-1}(\cdot) - \frac{\partial V_{i-1}}{\partial y_{i-1}} b_{i-2}(\cdot) - K_i y_i \right), \quad \forall i > 2, K_i > 0$$

avec $\alpha_1 = -K_1 y_1$ et α_2 donné en (0.4). Dans la dernière étape, le contrôleur $u_c = \alpha_{m+1}(\cdot)$ est conçu avec la sortie passive pour le système complet comme $y_m = \xi_m - \alpha_m(\cdot)$. Lié à cette sortie le système, avec le $\alpha_{m+1}(\cdot)$ comme entrée, a un degré relatif égal à 1.

0.2.3 La conception Backstepping échantillonné - avec une échelle de temps

Soit $x^T = [z^T \ y^T]^T$ l'état du système continu obtenu à partir de la bouclage par u_c du système (0.1)-(0.2) et transformé, réécrit comme

$$\dot{x}(t) = f_c(x(t)) + g_c(x(t))u_c(t) \quad (0.8)$$

avec

$$f_c = \begin{bmatrix} f(z) + g(z)(\phi(z) + y) \\ a(z, y + \phi(z)) - \frac{\partial \phi}{\partial z} \dot{z} \end{bmatrix}, \quad g_c = \begin{bmatrix} 0 \\ b(z, y + \phi(z)) \end{bmatrix}.$$

Si on suppose $u_c(t) = u_k$ pendant chaque période d'échantillonnage δ , alors l'équivalent échantillonné du système (0.8) est décrit par la dynamique:

$$x_{k+1} = F_d^\delta(x_k, u_k) = e^{\delta(f_c + u_k g_c)} x_k \quad (0.9)$$

avec les notations introduites au Chapitre 1. Étant donné u_c comme en (0.4) et la fonction de Lyapunov $V(z, \xi)$ avec dérivée négative, on calcule par intégration:

$$V(x_c|_{t=(k+1)\delta}) - V(x_c|_{t=k\delta}) = \int_{k\delta}^{(k+1)\delta} \dot{V}(x_c(\tau)) d\tau, \quad (0.10)$$

où l'on note x_c l'état du système continu bouclé par u_c comme en (0.4).

Ensuite, nous appliquons le critère de la reproduction du lien entrée/Lyapunov. Autrement dit, la synthèse échantillonnée consiste à calculer une loi de commande constante par morceaux u_k qui reproduit, à chaque instant d'échantillonnage $t = k\delta$, la différence cible (0.10); u_k doit satisfaire l'égalité:

$$V(x_{k+1}) - V(x_k) = \int_{k\delta}^{(k+1)\delta} \dot{V}(x_c(\tau)) d\tau. \quad (0.11)$$

avec $x_k = x_c(t = k\delta)$ et x_{k+1} est calculé selon (0.9). Donc la commande digitale u_k reproduit, aux instants d'échantillonnage, l'évolution de la fonction Lyapunov du système bouclé en temps continu et permet d'obtenir la même stabilisation asymptotique du système échantillonné aux instants d'échantillonnage.

Theorem 2. [Tiefensee 2010] Etant donné un système sous la forme "strict-feedback" (0.1)-(0.2), en supposant l'existence d'un contrôleur u_c en temps continu calculé à partir de la méthode "backstepping", tel qu'il existe une fonction de Lyapunov V , qui garantit la stabilité du système initial; alors il existe $\Gamma^* > 0$ tel que, pour chaque δ en $(0, \Gamma^*]$ il existe une loi de commande échantillonnée $u_k = u_d^\delta$ qui assure la même évolution de Lyapunov aux instants d'échantillonnage et garantit la stabilisation asymptotique de l'origine du système.

Remark 3. Le théorème précédent peut être formulé globalement ou localement selon les hypothèses prises pour la conception du contrôleur en temps continu.

0.2.3.1 Calculs du contrôleur

La solution proposée dans le Theorem 2 est définie comme une série infinie en δ . Pour des raisons pratiques, des solutions approchées sont proposées. La loi de commande approchée au deuxième ordre est définie comme :

$$u_d^{\delta 2} = u_{d0} + \frac{\delta}{2!} u_{d1} + \frac{\delta^2}{3!} u_{d2} \quad (0.12)$$

Les premiers termes de ce contrôleur sont calculés comme suit:

$$u_{d0}(z_k, y_k) = u_c(z, y)|_{t=k\delta} \quad (0.13)$$

$$\begin{aligned} u_{d1}(z_k, y_k) &= \dot{u}_c(z, y)|_{t=k\delta} \\ &= \frac{\partial u_c(z, y)}{\partial z} (f(z) + g(z)(\phi(z) + y))|_{t=k\delta} \\ &\quad + \frac{\partial u_c(z, y)}{\partial y} (a(z, y + \phi(z)) - \dot{\phi}(z))|_{t=k\delta} \end{aligned} \quad (0.14)$$

$$u_{d2}(z_k, y_k) = \ddot{u}_c(z, y)|_{t=k\delta} + \frac{u_{d1}(z_k, y_k)}{2b(z, y + \phi(z))y} \mathbf{ad}_{[f_c, g_c]} V|_{t=k\delta}. \quad (0.15)$$

avec

$$\begin{aligned}
\mathbf{a}d_{[f_c, g_c]}V|_{t=k\delta} &= \frac{\partial \mathbf{b}(z, \mathbf{y} + \Phi(z))}{\partial z} \mathbf{y} (f(z) + g(z)(\Phi(z) + \mathbf{y}))|_{t=k\delta} \\
&+ \left(\mathbf{b}(z, \mathbf{y} + \Phi(z)) + \mathbf{y} \frac{\partial \mathbf{b}(z, \mathbf{y} + \Phi(z))}{\partial \mathbf{y}} \right) (\mathbf{a}(z, \mathbf{y} + \Phi(z))(z))|_{t=k\delta} \\
&- \left(\frac{\partial W}{\partial z} (f(z) + g(z)) + \frac{\partial \mathbf{a}(z, \mathbf{y} + \Phi(z))}{\partial \mathbf{y}} (z) \right) \mathbf{b}(z, \mathbf{y} + \Phi(z))|_{t=k\delta}
\end{aligned} \tag{0.16}$$

Ces expressions sont bien définies puisque selon la procédure de “backstepping” $\mathbf{b}(z + \Phi(z))\mathbf{y} \neq 0$.

0.2.4 Backstepping échantillonné - la conception multi-échelle de temps

La technique d'échantillonnage multi-échelles a été proposée dans le contexte des systèmes non linéaires pour la préservation sous échantillonnage de la stabilité interne (dynamique des zéros) [Monaco & Normand-Cyrot 2001]. Une loi de commande échantillonnée à m échelles de temps signifie, dans le contexte actuel, que les variables de contrôle sont échantillonnées plus rapidement (m -fois) que les variables mesurées. L'entrée $u(t)$ est supposée constante sur des intervalles d'amplitude $\bar{\delta} = \delta/m$ permettant ainsi m valeurs différentes du contrôleur sur chaque intervalle d'amplitude δ . L'idée principale est que de multiples changements des variables de contrôle, au cours de la période d'échantillonnage, augmentent les degrés de liberté de la dynamique qui décrit le système échantillonné. On montre, par exemple dans [Monaco & Normand-Cyrot 2007], que l'utilisation de cette technique fournit les mêmes performances que l'utilisation d'un bloqueur d'ordre supérieur et de l'échantillonnage généralisé [Djemai *et al.* 1999].

0.2.4.1 La motivation

La conception échantillonnée de type “backstepping” proposée dans la dernière section propose un contrôleur numérique $u_{\delta}^{\bar{\delta}}$ qui reproduit à chaque instant d'échantillonnage l'évolution d'une fonction de Lyapunov totale $V(z, \mathbf{y})$. Pour des raisons pratiques des solutions approchées ont été considérées. Dans les études effectuées, il est montré qu'un contrôleur approché d'ordre p assure la reproduction de l'évolution de la fonction Lyapunov avec une erreur en δ^{p+1} ($O(\delta^{p+1})$). Selon la procédure du “backstepping”, $V(z, \mathbf{y}) = W(z) + \frac{1}{2}\mathbf{y}^2$ avec W une autre fonction Lyapunov qui assure la stabilisation de la première dynamique (0.2) quand \mathbf{y} tend vers 0 (stabilisation interne). Le contrôleur proposé pour la reproduction de V offre des performances insuffisantes pour la reproduction de W . Plus précisément, la reproduction de la fonction $W(z)$ avec un contrôleur approché d'ordre p est assurée avec une erreur en δ^3 .

La conclusion est claire. La condition imposée pour reproduire l'évolution de V n'assure pas la reproduction de W . Comme conséquence, sous échantillonnage, les performances de stabilisation, assurées par W , ne sont plus préservées et une déstabilisation peut survenir.

L'idée est d'assurer la reproduction de V et de W sous commande échantillonnée avec une solution à double échelles de temps.

0.2.4.2 La solution à double échelles de temps

Revenant à la connexion avec une cascade de type (0.1)-(0.2), ce système a un degré relatif égal à 2, par rapport à la sortie $y = x_1$, il est naturel de proposer une procédure impliquant deux échelles de temps. Nous considérons donc deux contrôleurs échantillonnés constants par morceaux sur l'intervalle d'échantillonnage $\bar{\delta} = \frac{\delta}{2}$ avec ces hypothèses:

- A. u_{1k} est actif et constant $\forall t \in [k\delta, k\delta + \delta/2)$,
- B. u_{2k} est actif et constant $\forall t \in [k\delta + \delta/2, (k+1)\delta)$.

Les dynamiques équivalentes du système (0.8) sous l'action des contrôleurs (u_{1k}, u_{2k}) sont données par la composition fonctionnelle:

$$x_{k+1} = F_d^\delta(x_k, u_{1k}, u_{2k}) = e^{\text{BCH}^2\left(\frac{\delta}{2}(f_c + u_{1k}g_c), \frac{\delta}{2}(f_c + u_{2k}g_c)\right)} \quad (0.17)$$

avec BCH^2 - l'exposant généralisé d'ordre 2 de la formule de Baker-Campbell Hausdorf.

Cette représentation met en évidence la contribution des deux contrôleurs échantillonnés sur les dynamiques d'états.

En appliquant les idées de la section précédente, le premier objectif qui doit être imposé est celui du [Theorem 2](#):

$$V(x_{k+1}) - V(x_k) = \int_{k\delta}^{(k+1)\delta} \dot{V}(x_c(\tau)) d\tau. \quad (0.18)$$

où x_{k+1} est calculé à partir de (0.17).

Le deuxième objectif est donné par la dynamique du premier sous-système de (0.1) pour lequel il existe une fonction de Lyapunov $W(z)$, qui garantit les propriétés de stabilité de cette dynamique. Sous échantillonnage, il est naturel de considérer, aussi, la reproduction de W . Le deuxième objectif est:

$$W(x_{k+1}) - W(x_k) = \int_{k\delta}^{(k+1)\delta} \dot{W}(x_c(\tau)) d\tau. \quad (0.19)$$

avec x_{k+1} calculé à partir de (0.17).

Toutes ces observations sont résumées dans le Théorème suivant :

Theorem 4. *Etant donné un système sous la forme “strict-feedback” (0.1)-(0.2), en supposant l’existence d’un contrôleur u_c en temps continu calculé à partir de la méthode “backstepping”, tel qu’il existe des fonctions Lyapunov V et W , qui garantissent la stabilité du système initial; alors il existe $T^* > 0$ tel que pour chaque δ appartenant à $(0, T^*]$ il existe une loi de commande échantillonnée à double échelles de temps $u_k = (u_{1k}, u_{2k})$ avec $u_{1k} = u_{1d}^{\bar{\delta}}$, $u_{2k} = u_{2d}^{\bar{\delta}}$ qui assure les mêmes évolutions des fonctions Lyapunov sous échantillonnage et qui garantit la stabilisation asymptotique de l’origine du système.*

Dans ce cas, le contrôleur à double échelles de temps, approché d’ordre 2 est donné par les expressions suivantes:

$$(u_{d10}, u_{d20}) = (u_c|_{x_k}, u_c|_{x_k}) \tag{0.20}$$

$$(u_{d11}, u_{d21}) = \left(\frac{2}{3}\dot{u}_c \Big|_{x_k}, \frac{10}{3}\dot{u}_c \Big|_{x_k} \right) \tag{0.21}$$

$$\begin{aligned} u_{d12} &= \frac{4}{3}\dot{u}_c \left(4u_c L_{g_c}^2 L_{f_c} + L_{g_c} L_{f_c}^2 \right) W \cdot (L_{g_c} L_{f_c} W)^{-1} - 6\dot{u}_c u_c L_{g_c} V \cdot (L_{g_c} V)^{-1} \Big|_{x_k} \\ u_{d22} &= 8\dot{u}_c + 12\dot{u}_c u_c L_{g_c} V \cdot (L_{g_c} V)^{-1} - u_{d21} \Big|_{x_k}. \end{aligned} \tag{0.22}$$

Ces expressions sont bien définies puisque par hypothèse $L_{g_c} L_{f_c} W = \frac{\partial W}{\partial x_1} g(x_1) b(x_1, x_2) \neq 0, \forall x_k \neq 0$.

0.2.4.3 La solution à m échelles de temps

Dans ce paragraphe, nous formulons la solution pour le cas général - de $m + 1$ sous-systèmes en cascade. Considérons le système général donné par les équations (0.6) avec $m + 1$ fonctions de Lyapunov comme définies par (0.7). Ensuite, considérons la même forme compacte (0.8), avec les fonctions définies au paragraphe 0.6.

Dans ce cas, il est naturel de proposer une procédure impliquant $m + 1$ échelles de temps avec la période d’échantillonnage $\bar{\delta} = \frac{\delta}{m+1}$. Dans ce contexte, nous considérons $m + 1$ contrôleurs échantillonnés constants par morceaux sur l’intervalle d’échantillonnage $\bar{\delta}$ sous les hypothèses:

1. u_{ik} est actif et constant $\forall t \in [k\bar{\delta} + (i - 1)\bar{\delta}, k\bar{\delta} + i\bar{\delta})$, où $1 \leq i \leq m + 1$.

Les dynamiques équivalentes du système (0.8) sous l’action des $m + 1$ contrôleurs sont données par

$$x_{k+1} = F^{\bar{\delta}}(x_k, u_{1k}, u_{2k}, \dots, u_{m+1k}) = e^{BCH^{m+1}(\bar{\delta}(f_c + u_{1k}g_c), \bar{\delta}(f_c + u_{2k}g_c), \dots, \bar{\delta}(f_c + u_{m+1k}g_c))} \tag{0.23}$$

De façon similaire, nous devons trouver les expressions des contrôleurs telles que les propriétés de stabilisation correspondent à celles du système en temps continu. Dans ce cas, $m + 1$ objectifs peuvent être imposés pour reproduire $m + 1$ fonctions Lyapunov qui sont définies.

Le Théorème suivant donne la solution de contrôle multi-échelles pour le cas général.

Theorem 5. *Etant donné un système sous la forme "strict-feedback" (0.6), en supposant l'existence d'un contrôleur u_c en temps continu calculé à partir de la méthode "backstepping", tel qu'il existe des fonctions Lyapunov W, V_1, \dots, V_m , qui garantissent la stabilité du système initial; alors il existe $T^* > 0$ tel que pour chaque δ dans l'intervalle $(0, T^*]$ il existe une loi de commande échantillonnée à $m + 1$ échelles de temps $u_k = (u_{1k}, u_{2k}, \dots, u_{m+1k})$ avec $u_{ik} = u_{i\delta}^{\bar{\delta}}$, $i = 1, m + 1$ qui assure les mêmes évolutions des fonctions Lyapunov aux instants d'échantillonnage et garantit la stabilisation asymptotique de l'origine du système.*

0.2.4.4 La solution de la loi de commande échantillonnée approchée

Cette stratégie de conception impose à chaque contrôleur la reproduction des propriétés de stabilité de chaque sous-système, à l'aide des $m + 1$ fonctions Lyapunov. Pour un m grand, il est clair que cette méthode devient difficile à mettre en œuvre en pratique.

Il est intéressant de remarquer que le contrôleur à multi-échelles de temps, approché à l'ordre 1 assure la reproduction de la fonction de Lyapunov V_m avec une erreur en $O(\delta^3)$ et pour la fonction W l'erreur est m fois plus petite $O(\delta^{m+2})$. Le calcul exact des premiers termes d'un contrôleur approché à m échelles de temps est une tâche difficile, sauf au premier ordre.

Les solutions du premier ordre du contrôleur à multi-échelles de temps pour le cas $m = 2$ et $m = 3$ sont les suivantes :

$$(u_{1d1}, u_{2d1}, u_{3d1}) = \left(\frac{3}{4} \dot{u}_c \Big|_{x_k}, 3 \dot{u}_c \Big|_{x_k}, \frac{21}{4} \dot{u}_c \Big|_{x_k} \right) \quad (0.24)$$

$$(u_{1d1}, u_{2d1}, u_{3d1}, u_{4d1}) = \left(\frac{332}{45} \dot{u}_c \Big|_{x_k}, \frac{68}{15} \dot{u}_c \Big|_{x_k}, \frac{52}{15} \dot{u}_c \Big|_{x_k}, \frac{28}{45} \dot{u}_c \Big|_{x_k} \right) \quad (0.25)$$

Ces expressions sont bien définies puisque par construction $L_{g_c} L_{f_c}^i V_{m-i} \neq 0$, $\forall x_k \neq 0$.

Remark 6. *La solution approchée d'ordre p à $m + 1$ échelles de temps $u_d^{\bar{\delta}^p}$ stabilise asymptotiquement le système avec m connections en cascade avec une erreur $O(\delta^{p+1})$ sur la reproduction de V_m , respectivement une erreur $O(\delta^{p+m+1})$ pour W .*

Cela signifie que le contrôleur à m multi-échelles de temps sera capable de maintenir toutes les propriétés de stabilisation des dynamiques internes. La première dynamique z , ce qui dans de nombreuses situations pratiques a un intérêt majeur, est favorisée par cette conception. L'approche multi-échelles peut être utilisée avec succès dans le cas de systèmes avec une chaîne d'intégrateurs, lorsque les solutions émulées ne fonctionnent pas, même pour des périodes d'échantillonnage plus faibles.

0.2.4.5 Quelques observations concernant d'autres stratégies similaires

Dans l'article de [Nešić & Teel 2006] une conception échantillonnée calculée sur l'approximation d'Euler du modèle continu est proposée. Les résultats obtenus assurent une stabilisation semi-globale et pra-

tique du modèle exact. La principale différence entre la solution proposée dans [Nešić & Teel 2006] et la nôtre est que le contrôleur est construit sur un modèle en temps discret approché, alors que nous considérons un modèle échantillonné exact et les approximations sont apportées seulement sur le contrôleur. En conséquence, notre solution est plus performante, en termes de propriétés de stabilité comme il est souligné par les résultats des simulations. Un autre aspect est que notre approche est développée pour toutes les dynamiques non-linéaires décrites par des champs de vecteurs.

Dans l'article [Nešić & Grüne 2005], deux solutions échantillonnées ont été développées à partir de contrôleurs conçus en temps continu, ayant comme base des fonctions Lyapunov. La première solution impose une plus forte négativité de la fonction de Lyapunov que le contrôle émulé. La deuxième solution réduit les erreurs entre les évolutions continues et échantillonnées de Lyapunov. La spécificité de notre approche est de faire correspondre exactement les évolutions Lyapunov et pas seulement de "minimiser" l'écart. Toutefois, les deux approches coïncident au premier ordre d'approximation.

Un autre travail de [Burlion *et al.* 2006], s'appuie sur les travaux [Nešić & Teel 2001], [Nešić & Grüne 2005] et affirme la reproduction exacte de la fonction de Lyapunov. La procédure de conception est développée seulement sur la version la plus simple des systèmes "strict-feedback". Aucune généralisation et aucuns commentaires sur la manière dont la solution peut fournir une stabilisation globale.

Toutes ces solutions devraient être plus performantes pour des périodes d'échantillonnage plus importantes, par rapport au cas des contrôleurs émulés. Comme il est souligné par les simulations obtenues, un ordre élevé du contrôleur approché conduit à des expressions plus complexes et, comme conséquence à plus d'instabilité quand δ est élevé. C'est la raison pour laquelle, les solutions du premier ordre sont préférables, elles fonctionnent pour des périodes d'échantillonnage plus importantes que les contrôleurs d'ordre supérieur.

DEUXIÈME PARTIE. SIMNLSYS - UN LOGICIEL POUR LA CONCEPTION ÉCHANTILLONNÉE

0.2.5 Les objectifs et la structure de la boîte à outils

Le logiciel proposé **CAOC -SimNLSys-** est réalisé comme une application graphique en Matlab⁷. Ce logiciel combine les fonctions graphiques d'une application d'interface utilisateur avec les solutions fournies par les outils numériques et symboliques. Ses principaux objectifs sont:

- aider à la conception des contrôleurs échantillonnés pour un certain nombre des stratégies disponibles pour le contrôle non linéaire;
- fournir des outils dédiés pour la simulation et l'évaluation des performances des contrôleurs échantillonnés, avec des tests comparatifs;

SimNLSys est conçu comme une boîte à outils dans Matlab pour la conception de contrôleurs échantillonnés pour des systèmes non linéaires. Cette spécificité du logiciel permet de combler le vide qui existe dans ce domaine. L'idée de base est de calculer automatiquement les expressions symboliques des contrôleurs, à partir de la dynamique d'état continue du système et suivant une méthodologie spécifique. La méthodologie développée par Salvatore Monaco et Dorothee Normand-Cyrot [Monaco & Normand-Cyrot 2001, Monaco *et al.* 2007, Monaco & Normand-Cyrot 2007] [Monaco & Normand-Cyrot 2009, Monaco *et al.* 2011] offre des résultats spécifiques qui permettent de proposer des algorithmes symboliques. Par conséquent, les expressions peuvent être utilisées dans une application en temps réel pour le contrôle d'une installation physique. De cette façon, cette boîte à outils représente un lien nécessaire entre la théorie et les applications pratiques.

Comme il a déjà été souligné dans les objectifs, la deuxième caractéristique du logiciel **SimNLSys** est représentée par les outils de simulation. Ces outils, qui mettent en œuvre des algorithmes numériques, permettent de fournir des tests spécifiques pour les systèmes échantillonnés et d'évaluer, en vertu des critères définis, les performances du contrôleur calculé par le logiciel **SimNLSys**.

La structure de **SimNLSys** est représentée dans Figure 0.2

L'architecture du logiciel comprend plusieurs modules:

⁷ Un produit MathWorks <http://www.mathworks.com/products/matlab>



Figure 0.2: La fenêtre principale de SimNLSys

- module de conception
 - module - reproduction entrée-sortie/fonction Lyapunov - **IOMatch**
 - module - backstepping - **Bks**
 - module - contrôle non linéaire optimal -**NLOptSD**

- modules des simulations - **Sim1,Sim2**

0.2.5.1 *Module de conception de la loi de commande*

La conception des contrôleurs est basée sur les capacités de la boîte à outils symbolique de Matlab. L'utilisation d'outils symboliques apporte un grand avantage pour les applications de CAO et pour toutes les personnes engagées dans des activités de recherche ou industrielles qui doivent manipuler et calculer les expressions. L'absence d'erreurs d'arrondi et de cumul, spécifiques au cas numérique, la manipulation des expressions symboliques sont des avantages de cet outil pour la conception de contrôleurs non linéaire.

Dans l'application **SimNLSys**, la boîte à outils Matlab symbolique (actuellement connectée à un moteur MuPAD) est utilisée pour calculer les expressions des commandes numériques. Ces expressions, obtenues sous une forme symbolique, sont adaptées pour être mises en œuvre sur des dispositifs de commande.

Il a été nécessaire, dans un premier temps de définir quelques fonctions de base qui calculent la dérivée de Lie, la jacobienne, le crochet de Lie ou l'inverse d'une fonction multidimensionnelle. Une attention particulière a été accordée aux manipulations matricielles qui sont essentielles dans le cas MIMO.

La présentation est concentrée sur le développement symbolique des algorithmes pour le problème de la reproduction entrée-sortie qui représente le cœur des algorithmes développés. À partir de cet algorithme, d'autres algorithmes ont été conçus pour la reproduction entrée/Lyapunov et pour la conception du "backstepping" échantillonnées qui reposent sur les mêmes concepts. Des résultats sont également donnés dans le cas à multi-échelles de temps, où une difficulté majeure réside pour le calcul des des exposants BCH.

0.2.5.2 Modules des simulations

La boîte à outils fournit deux modules de simulation, l'un pour le cas à une échelle de temps (**Sim1**) et l'autre (**Sim2**) qui gère les scénarios les plus difficiles comme les contrôleurs multi-échelles, les systèmes non linéaires avec contraintes ou les systèmes qui incluent d'autres non-linéarités statiques.

Le développement de cette boîte à outils est toujours en cours parallèlement à de nouvelles méthodologies. Chaque architecture de module peut être décrite par trois composantes:

- *Le niveau utilisateur* - l'interface du logiciel, où les données sont précisées et les résultats sont affichés;
- *Le niveau code* -représenté par les algorithmes de conception et par l'exécution;
- *Le niveau des données* - représenté par les résultats.

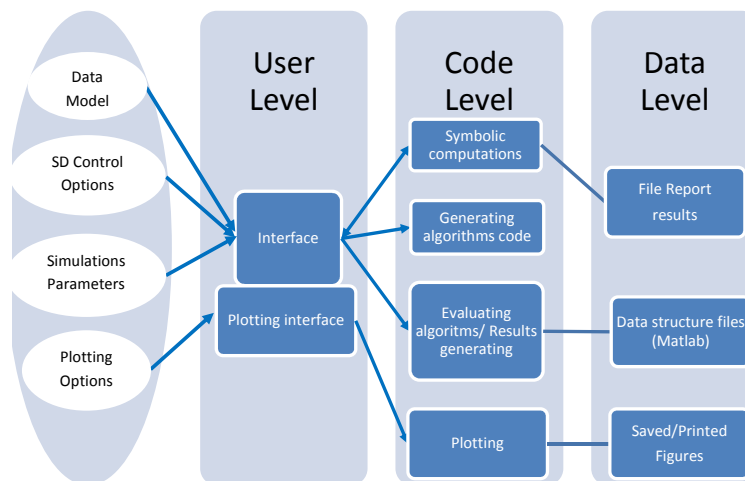

Figure 0.3: L'architecture du logiciel

En [Figure 0.3](#) le flux de travail de l'ensemble de l'application SimNLSys est représenté. Un utilisateur interagit avec l'application via les interfaces où il peut spécifier les données d'entrée (modèle de processus, paramètres de simulation), puis calcule les solutions qui en résultent (expressions du contrôleur, fichiers de données, fichiers image). À la dernière étape, il peut utiliser les outils fournis par

ce logiciel pour visualiser, enregistrer ou imprimer les solutions. Les solutions obtenues peuvent être utilisées pour d'autres manipulations dans Matlab. Tous les algorithmes implémentés dans le logiciel sont assignés à un "code de niveau", inaccessible aux utilisateurs.

0.2.5.3 *Fonctionnement du logiciel*

L'interface de communication entre l'utilisateur et le logiciel est implantée à partir d'une fenêtre principale, permettant l'entrée des données du modèle, de la simulation et de l'analyse. Il faut remarquer que toutes les fonctions qui sont introduites doivent respecter les syntaxes imposées par Matlab, les états sont exprimés par x_1, \dots, x_n , et le temps par t .

TROISIÈME PARTIE. ÉTUDES DE CAS

0.3 CONTRÔLE D'UNE SUSPENSION ÉLECTROMAGNÉTIQUE

Cette étude de cas présente des résultats expérimentaux obtenus sur un banc d'essai d'une suspension électromagnétique disponible au Département d'Automatique de Supelec (Figure 0.4). Ce système est composé d'un électro-aimant fixe, alimenté par une source de courant variable, et un pendule ferromagnétique.

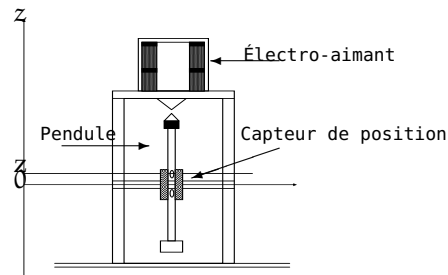

Figure 0.4: Suspension électromagnétique

La solution échantillonnée proposée repose sur la stratégie "backstepping" développée proposée dans cette thèse (la version avec une échelle de temps). La conception est réalisée sur une modèle d'état de dimension 2, (0.26).

$$\begin{aligned}\dot{x}_1(t) &= x_2(t) \\ \dot{x}_2(t) &= \frac{c \cdot K_v^2}{m} \frac{v^2}{(x_0 - x_1(t))^2} - g\end{aligned}\tag{0.26}$$

où x_1 est la position du pendule, x_2 la vitesse et v l'entrée (source de courant). Les essais expérimentaux ont été centrés sur l'évaluation des performances de stabilisation des trois contrôleurs : émulé, ordre 1 et 2 du contrôleur approché. Les résultats montrent que des performances supérieures sont obtenues avec le contrôleur du deuxième ordre. Dans ce cas, on constate que la stabilisation est obtenue pour un période d'échantillonnage et respectivement pour un gain plus large que celles obtenues dans le cas d'un contrôleur émulé.

0.4 CONTRÔLE DU NIVEAU DE L'EAU D'UN SYSTÈME DES RÉSERVOIRS COUPLÉS

L'objet de cette étude de cas est de mettre en évidence, sur un système physique - réservoirs d'eau couplés, les performances d'une conception échantillonnée d'un contrôleur conçu en temps continu et basée sur la passivité. Le banc d'essais expérimental est disponible à l'Université Politehnica de Bucarest.

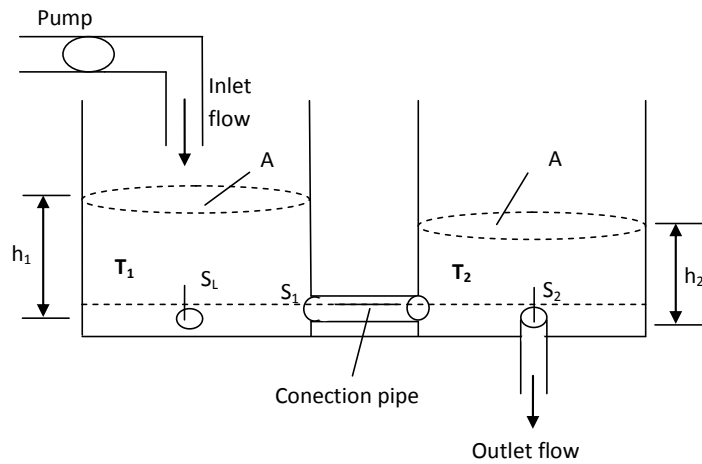

Figure 0.5: Schéma des réservoirs couplés

La conception du contrôleur est réalisée à partir d'un modèle d'état de dimension 2, (0.27)-(0.28).

$$\dot{h}_1 = \frac{1}{A} Q_i(t) - \frac{1}{A} c_1 \sqrt{|h_1 - h_2|} \text{sign}(h_1 - h_2) \quad (0.27)$$

$$\dot{h}_2 = \frac{1}{A} c_1 \sqrt{|h_1 - h_2|} \text{sign}(h_1 - h_2) - \frac{1}{A} c_2 \sqrt{h_2} \quad (0.28)$$

où les états h_1 et h_2 représentent les niveaux d'eau dans chaque réservoir, Q_i est le débit d'entrée.

Comme dans l'étude du cas précédent, les résultats montrent une bonne performance de la commande échantillonnée en augmentant la période d'échantillonnage ou le gain des contrôleurs. Pour ce dispositif, de nouvelles implantations sont en cours, en considérant une stratégie uni et multi-échelles de temps du type "backstepping".

0.5 CONTRÔLE D'UN ROBOT MOBILE À DEUX ROUES

L'objet de cette étude de cas est d'illustrer comment la discrétisation rend plus facile la conception d'un stabilisateur en présence de retards de communication. Le système considéré est un robot mobile à deux roues Figure 0.6.

Les dynamiques non linéaires des mouvements du robot sont décrites par les équations (0.29). Avec une transformation de coordonnées et un bouclage appropriée, le système initial peut être décrit par

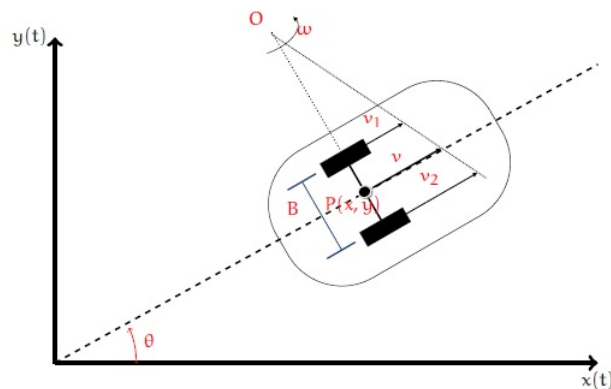

Figure 0.6: Robot a deux roues

des dynamiques sous forme "chainée" qui sont finement discrétisables. En présence de retards, cet aspect peut être exploité pour développer un prédicteur d'état exact.

$$\begin{aligned}
 \dot{x}(t) &= v(t) \cos(\theta(t)), \\
 \dot{y}(t) &= v(t) \sin(\theta(t)), \\
 \dot{\theta}(t) &= \omega(t)
 \end{aligned}
 \tag{0.29}$$

Le contrôleur a été développé dans le cas sans retard à partir d'une stratégie de synthèse discrète directe - réponse pile. Une solution à deux-échelles de temps a également été proposée. Les performances de ces contrôleurs sont préservées dans le cas avec retard sous la condition d'un retard connu.

0.6 GESTION ÉCHANTILLONNÉE DE L'ÉNERGIE D'UN SYSTÈME - PILE À COMBUSTIBLE-SUPER CONDENSATEURS

Dans cette étude de cas l'objectif est d'illustrer les performances d'une commande non linéaire échantillonnée pour la gestion de l'énergie d'un système composé d'une pile à combustible associée à un super condensateur - PàC-SC et une charge.

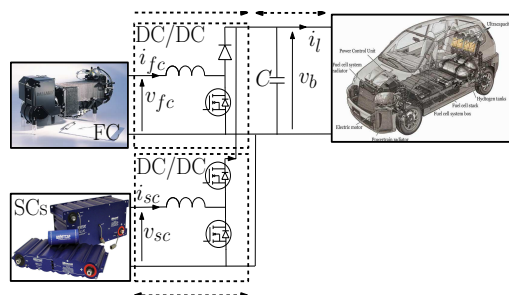

Figure 0.7: L'architecture du système [Ghanes et al. 2011]

L'objectif est de piloter la tension aux bornes de la charge en optimisant l'échange énergétique entre les deux sources, ceci pour solliciter dans un premier temps le super condensateur et dans un deuxième temps la pile qui a une réponse plus lente. Deux stratégies non linéaires ont été proposées à partir d'un modèle réduit de dimension 3 (0.30).

$$\begin{aligned}\dot{x}_1(t) &= \frac{1}{C} \left(\frac{v_{FC}}{x_1(t)} u_1(t) + \frac{x_2(t)}{x_1(t)} u_2(t) - x_3(t) \right) \\ \dot{x}_2(t) &= -\frac{u_2(t)}{C_{sc}} \\ \dot{x}_3(t) &= \frac{-R_1 x_3(t) + x_1(t)}{L_1}\end{aligned}\tag{0.30}$$

où x_1 et x_2 sont respectivement les tensions de bus et de la pile, x_3 le courant de charge, et u_1 et u_2 les entrées commandées.

Une première approche fait référence à la méthode de façonnement de l'énergie et utilise une conception de type Lyapunov reposant sur la notion de passivité - Interconnexion and Damping Assignment - Passivity Based Controller (IDA-PBC). Pour cette approche, des résultats en simulations et expérimentaux ont été obtenus. Le banc d'essai expérimental est disponible au LGEP, CNRS-UMR 8507, Gif-sur-Yvette.

La deuxième approche exploite la structure à deux échelles de temps des deux sources de courant (pile et super condensateur) et propose une stratégie aux perturbations singulières.

Les objectifs de contrôle (pour les deux stratégies) ont été imposés en temps continu et les performances des versions échantillonnées proposées ont été comparées à un simple bloqueur d'ordre zéro. La période d'échantillonnage utilisée sur le banc d'essai expérimental est de l'ordre de la milli seconde pour laquelle la solution émulée par BOZ reste satisfaisante. Toutefois les performances de la loi émulée par BOZ sont très sensibles au choix des paramètres de réglage choisis en temps continu. Les résultats de simulation montrent que si l'on choisit des paramètres associés à une réponse rapide, les solutions émulées par BOZ se dégrade avec l'augmentation de la période d'échantillonnage. Pour ces situations les solutions échantillonnées proposées d'ordre 1 sont nécessaires et apportent des améliorations significatives.

0.7 LES EFFETS DE L'ERREUR DE QUANTIFICATION DANS LES SYSTÈMES ÉCHANTILLONNÉS

La dernière étude de cas représente une analyse préliminaire sur les effets de l'erreur de quantification dans les systèmes échantillonnés avec des contrôleurs "backstepping" numériques proposés dans la première partie de la thèse. L'analyse est effectuée sur le même exemple académique développé dans le Chapitre 4 afin de vérifier la dégradation des propriétés de stabilisation.

Le contrôle étant fortement non linéaire, étudier les effets des quantifications est fortement demandé. Cette étude établit un bilan de solutions proposées vis à vis du gain, de la période d'échantillonnage, de degré de l'approximation des contrôleurs et la précision numérique.

CONCLUSIONS GÉNÉRALES ET TRAVAUX FUTURS

0.8 CONCLUSIONS GÉNÉRALES

La thèse apporte des contributions importantes pour le contrôle des systèmes échantillonnés non linéaires. L'un des objectifs principaux de ce travail est de migrer des solutions "idéales" - la synthèse d'un contrôleur en temps continu- adossée à une théorie rigoureuse- vers des réalisations pratiques. Les avancées théoriques, faites dans cette thèse, ont contribué à une série d'applications pratiques de ces stratégies. Les résultats obtenus pour ces applications, ont montré qu'une conception échantillonnée convenable peut récupérer la performance de contrôles "idéaux" proposés en temps continu, dégradée par l'échantillonnage. Dans ce travail, les stratégies non linéaires de type "backstepping", conception de type Lyapunov, IDA-PBC, aux perturbations singulières ont été discutées et adaptées aux systèmes échantillonnés. Dans le même temps, une attention particulière a été portée au développement d'algorithmes symboliques afin d'aider au calcul explicite de ces contrôleurs.

Les conclusions plus précises peuvent être divisées en trois parties, de la même manière que la structure de la thèse. Chaque partie correspond à une direction complémentaire sur laquelle cette thèse apporte des contributions.

0.8.1 *Les contributions théoriques*

Dans cette thèse, les performances des stratégies de reproduction entrée/Lyapunov dans le cadre de la méthode de stabilisation de type "backstepping", et le contrôle basé sur la passivité ont été discutées. Deux nouvelles stratégies de commande ont été conçues et développées: une approche avec une échelle de temps et une approche multi échelles de temps. Il est montré que les résultats sont meilleurs, en termes de propriétés de stabilisation, par rapport à l'émulation habituelle des contrôleurs "backstepping" en temps continu. La version multi échelles permet d'imposer une meilleure performance concernant la stabilité interne. L'approche multi échelles a permis d'augmenter le nombre d'objectifs de contrôle imposés. Les performances de ces contrôleurs ont été comparées à des procédures similaires disponibles dans la littérature. La version multi échelle s'est révélée la meilleure

méthode en termes de préservation de la stabilité, augmentation des gains (rapidité) et l'amplitude de la période d'échantillonnage (réduction des effets de quantification).

0.8.2 *Le logiciel SimNLSys*

Une autre direction importante est représentée par l'application de tip CAO. Ce travail est toujours en cours et il s'appuie en particulier sur les outils symboliques fournis par l'environnement Matlab. Les avantages de l'utilisation des outils symboliques et aussi leurs limites en se référant à l'application **SimNLSys** ont été expliqués. Un autre aspect mentionné est que le logiciel inclue des algorithmes symboliques et numériques, et des éléments graphiques. Le temps du calcul de ces solutions n'est pas critique puisque c'est un processus "hors ligne". La complexité croissante avec l'ordre du système et l'ordre d'approximation du contrôleur peut générer problèmes de mémoire physique disponible.

0.8.3 *Applications*

Une direction importante de la thèse est représentée par les exemples (académiques ou expérimentaux) qui illustrent les performances des stratégies proposées.

La version "backstepping" à une échelle de temps est évaluée sur un banc d'essai expérimental d'une suspension électromagnétique (disponible au Département Automatique de Supélec, Gif-sur-Yvette). Les résultats de simulation ont été confirmés par les tests expérimentaux. Cette étude de cas représente un exemple réel où la conception échantillonnée permet effectivement de meilleures performances par rapport aux versions émulées. Un fait important a également été observé en ce qui concerne le temps de stabilisation du contrôleur qui est amélioré en utilisant l'approche échantillonnée.

La deuxième étude de cas, utilise les mêmes critères de reproduction entrée/Lyapunov pour la conception d'une version échantillonnée d'un contrôleur $L_g V$. Le contexte de cette étude est caractérisé par les propriétés de passivité et la façon dont celles-ci peuvent être conservées sous échantillonnage. Le banc d'essai disponible à l'Université Polithenica de Bucarest consiste en deux réservoirs d'eau couplés. Il s'agit aussi de résultats expérimentaux.

La troisième étude de cas illustre deux aspects distincts sur l'exemple d'un robot mobile. Le premier porte sur une conception numérique directe, quand il existe un modèle équivalent exact en temps discret du système. L'autre, aborde les problèmes de retard dans la communication. Dans cette étude,

un stabilisateur a été proposé couplé à un prédicteur d'état afin de gérer les retards de commande. Il s'agit d'un exemple simulé.

La quatrième étude de cas porte sur la gestion électrique d'une pile à combustible et super condensateurs et charge, un système utilisé dans l'industrie automobile. Les solutions échantillonnées proposées, à partir de deux stratégies non linéaires en temps continu, apportent des améliorations spécifiques. Cette étude a été réalisée dans le cadre du projet PEPS "Automatique" - GESE - Gestion Echantillonnée des Systèmes Energétique, soutenu par l'Institut CNRS-INSIS. Il s'agit ici de résultats expérimentaux et en simulation.

La dernière étude de cas est consacrée à l'étude des effets de quantification. Des simulations ont été réalisées afin d'évaluer comment la performance de reproduction entrée/Lyapunov est affectée par la quantification avec une erreur réduite, fonction de l'erreur de quantification.

Tous les calculs liés à la conception des contrôleurs, pour ces études de cas, ont été réalisés par logiciel **SimNLSys**.

0.8.4 Conclusion globale

Une conclusion globale est la suivante: *Le contrôleur échantillonné approché, conçu sur des critères de reproduction entrée/Lyapunov, offre une stabilisation asymptotique globale aux instants d'échantillonnage, et une stabilisation efficace quand il est mis en œuvre sur des systèmes réels. Cette conception permet d'augmenter les gains des contrôleurs ainsi que l'amplitude de la période d'échantillonnage, par rapport aux limites d'un contrôleur émulé. Avec l'augmentation de l'ordre d'approximation du contrôleur, les performances attendues sont supérieures mais au prix d'une complexité croissante des expressions et donc des erreurs de quantification.*

Bien que la plus petite valeur de δ donne des résultats satisfaisants pour le contrôle émulé, il y a des situations pour lesquelles cette valeur pourrait ne pas être acceptable pour le dispositif informatique d'acquisition et d'actionnement (comme ceci est illustré dans le cas de la suspension électromagnétique). Il y a donc l'avantage à rendre possible un élargissement de cette période. Bien que les périodes d'échantillonnage admissibles avec nos solutions soient toujours petites permettent les calculs du contrôle et les interfaces avec le banc d'essai.

0.9 TRAVAUX FUTURS

Les travaux futurs concernent la mise en œuvre et l'évaluation de nouvelles stratégies échantillonnées sur des installations expérimentales.

La version multi-échelles de temps du contrôleur "backstepping" devrait être testée prochainement. Comme les résultats de la simulation ont montré de performances, les mêmes attentes existent en pratique.

Pendant, comme le "backstepping" s'appuie fortement sur les propriétés de passivité, un schéma digital direct qui exploite cette propriété pourrait également être envisagé. Les travaux progressent dans cette direction.

Trois directions principales peuvent être lancées pour les travaux futurs.

0.9.1 *Les développements théoriques*

L'idée principale est de poursuivre le développement de nouvelles stratégies de commande échantillonnées provenant des stratégies non linéaires en temps continu, afin de migrer les résultats théoriques disponibles vers une utilisation plus pratique. Dans le même temps, une analyse rigoureuse des effets de l'échantillonnage et des paramètres de conception est obligatoire afin de fournir une caractérisation claire des performances d'un contrôleur échantillonné.

DES PERSPECTIVES SUR LES SOLUTIONS ÉCHANTILLONNÉES DE BACKSTEPPING Sur la base des conceptions échantillonnées proposées pour les systèmes "strict-feedback" les perspectives sont:

- La recherche de critères spécifiques permettant une analyse quantitative des performances en relation avec les périodes d'échantillonnage admissible, la rapidité de convergence, les incertitudes paramétriques ou les erreurs de quantification.
- Une conception échantillonnée associée à une version semi-globale en temps continu de "backstepping". Cette solution est moins restrictive et peut être utilisée lorsque l'on considère le cas de connexions en cascade multiples.

LA PASSIVITÉ ET L'OPTIMALITÉ Comme les stratégies de commande optimale directe et inverse s'appuient sur les propriétés de passivité, certaines extensions peuvent également être réalisées dans ce contexte. Une première tentative est discutée en [Monaco & Normand-Cyrot 2012] et [Tanasa *et al.* 2012]. La solution échantillonnée discutée vise à préserver les propriétés optimales de

stabilisation avec la même fonction Lyapunov V et avec un coût modifié. Une idée qui doit être étudiée est comment modifier la fonction de Lyapunov V sous échantillonnage ou modifier le critère afin d'obtenir un meilleur compromis stabilisation/optimalité.

LA THÉORIE DE PERTURBATIONS SINGULIÈRES Ce type de systèmes est caractérisé par de multiples échelles de temps, et une stratégie de contrôleur multi-échelles semble être plus appropriée. Une façon de d'aborder cette conception peut être l'adaptation de la méthodologie de la reproduction entrée/Lyapunov avec multiple échelles de temps au cas de systèmes singulièrement perturbés. Une application pratique est le problème de la gestion énergétique échantillonnée d'un système de pile à combustible [Hilairret *et al.* 2012].

LA SYNTHÈSE D'OBSERVATEUR ET LE RETARD Un autre aspect incontournable lors d'applications représente la synthèse d'observateurs. Il s'agit aussi de lier les aspects retards de commande et prédicteurs avec la mise en place d'observateurs. Une première tentative a été faite pour les systèmes avec retard, où un prédicteur d'états a été calculé en considérant le cas particulier d'un système de type "feed-forward" [Monaco *et al.* 2012].

0.9.2 Développement du logiciel

Des nouveaux modules du logiciel **SimNLSys** seront mis en œuvre pour de nouvelles avancées théoriques. Par exemple, en faisant référence aux concepts de passivité en moyenne - "average passivity" introduits en [Monaco *et al.* 2011, Tiefensee *et al.* 2009, Monaco *et al.* 2009]. Certaines procédures de conception ont été proposées et discutées en [Tiefensee 2010].

Une autre préoccupation forte est l'amélioration des algorithmes symboliques en utilisant de nouvelles techniques disponibles concernant simplification des expressions (par exemple pour les termes radicaux). Également un mécanisme efficace pour le compromis entre la vitesse de simplification de calcul d'expression devrait être étudié. Pour réduire le temps de calcul, une solution consiste à paralléliser les algorithmes existants.

Sur la partie simulations, des modules spécifiques devront permettre d'évaluer 'a-priori' les performances des contrôleurs échantillonnés. Une meilleure gestion d'un compromis pour le temps de calcul et la représentation minimale des ces expressions doit être proposée.

Un autre objectif est d'adapter ce logiciel à une large utilisation. Dans ce cas, une amélioration de la convivialité de l'interface est toujours nécessaire. Une autre idée, du point de vue de coût serait de migrer le logiciel dans un autre outil de développement gratuit tel Scilab.

0.9.3 Applications

La stratégie de "backstepping" multi-échelles pourra être testée sur le pendule électromagnétique et la plateforme réservoirs d'eau couplés, déjà étudiés dans cette thèse.

La gestion énergétique du système pile à combustible est ouvert à de nombreuses directions. Une conception échantillonnée qui peut être mise en œuvre fait référence à la stratégie de commande à multiple échelle de temps. La solution multi-échelles peut être utilisée soit sur le modèle réduit (dimension 3 du modèle de l'état), ou sur le modèle complet (dimension 5 du modèle d'état) en prenant en considération les vitesses différents des dynamiques. D'autres difficultés tels que les pertes électriques des convertisseurs et la présence de bruit dans les mesures devront être traitées.

Il y a un nombre important de problèmes réels de contrôle qui peuvent être abordés dans un contexte échantillonné. Des sujets très répandus de la recherche actuelle portent sur des exemples des problèmes sur les retards de communication, sur la gestion énergétique optimale où sur le contrôle basé sur la passivité. Les thèmes proposés dans cette thèse représentent un bon point de départ pour traiter de tels problèmes.

GENERAL INTRODUCTION

GENERAL INTRODUCTION

A short survey on the usual approaches found in the literature dealing with the design of digital controllers for nonlinear system is presented. Close to this presentation, another survey is related to the computer aided toolboxes available in the nonlinear control literature (to the best of the author's knowledge). Finally, some notations and theoretical recalls which concern nonlinear and sampled-data systems are given.

1.1 NONLINEAR SAMPLED-DATA CONTROL

The continuous development, in the last decades, of powerful computing systems has contributed to the increase of the performance demanded to control systems and hence an increased number of control solutions that cope with more challenging problems. As control solutions should add efficiency to the systems where these are applied, such as reduced costs or increased speed or precision, it is clear that control theory is an essential tool which contributes to economical and technological growth.

The nonlinear sampled-data control copes with two challenging problems: one is related to the nonlinear dynamics of the system and the other one takes into account the digital aspects unavoidable in real time applications.

The interest in nonlinear control is increased, especially for the reason that, in practice, all the existing systems in our environment are mostly nonlinear rather than linear [Isidori 1995], [Khalil 1996], [Rasvan & Stefan 2007], [Boucher & Dumur 2006]. In fact, many control solutions are based on linearizations or approximations of the real model and because of, important dynamics is neglected. Likewise the provided control has a linear behavior. For example, the trajectories of a vehicle modeled with nonlinear dynamics are more appropriate to real trajectories, but are more difficult to be achieved due to the complexity of designing such controllers. Another example is the pendulum motion. When linear equations are used, there is supposed that the angle, during the motion, is small. If this angle becomes larger the considered model and also the designed controller are no longer valid.

Another example is given by the thermal process. In the linear context, it is chosen a nominal point in a region where the thermal characteristic is linear. The model is valid only if during the run-time of the system the operating point is not rising above the nominal point for a specific threshold. Of course this fact is not sufficient and robust controllers should be developed to ensure the behavior of such a system in the preset conditions even in the presence of unmodeled dynamics or important disturbances.

A sampled-data system is operating in continuous-time and some of its signals are sampled at different time instants (usually considered periodically). The data-control system is, in the same context, a control law computed from the sampled data of the process measurements. This type of systems are also called “hybrid” because they involve both continuous and discrete-time evolutions. Sampled-data systems constitute the core of the embedded systems [Hanselmann 1987], [Chen & Francis 1995], [Astrom & Wittenmark 2011].

The digital controller has to offer a rebuild continuous-signal that is compatible with the process entry. There are important issues regarding sampling, quantification and signal reconstruction. The objective hence is to design a digital controller which satisfies the desired requirements for the given continuous-time plant. In the literature, different approaches do exist. A first approach is to design a continuous-time controller and then to discretize it and many solutions exist for discretizing filters. The performance of this solution is frequently not good enough. A second approach is to design a controller based on the sampled model of the plant and thus providing possibilities to impose digital control requirements (dead beat or minimum time response). A third approach takes into account for the design, the fact that the model and the controller are sampled (Sampled Data design). In the next paragraphs there are given more details about these three conceptual approaches.

- A. **Continuous-Time Design (CTD)** - The controller is designed in continuous time and it is implemented in discrete time. Usually the implementation in discrete time of a continuous-time system is made by means of sampling and holding devices such as the ZOH block. The ZOH-block samples the continuous-time signal with fixed rate and also produces a constant output over that rate. In this case, we talk about the *emulation* of a continuous-time controller and this represents the commonly used strategy when applying digitally a continuous-time controller. The major drawback is that the designed performance of the continuous-time controller could not be preserved under such a solution due to its sampling [Monaco *et al.* 1986], [Monaco & Normand-Cyrot 1986].

In the case of state-feedback controllers some works have been studying, for the nonlinear systems, the conditions, under which, the sampled-data controllers recover certain properties of the

continuous-time controller [Owen *et al.* 1990], [Zheng *et al.* 1990], [Clarke *et al.* 1997]. The results indicate that the global or local stabilizing properties are maintained under fast sampling. It was also highlighted that in presence of bounded disturbance the stabilization holds *practically*. Another problem derived is the estimation of the maximum sampling period for which such properties are maintained [Zheng *et al.* 1990],[Khalil 2004], [Nešić *et al.* 2009], [Postoyan 2009] or in the presence of disturbances, related also with the notion of input-state stability [Teel *et al.* 1998].

In order to compensate for the sampling effects, some strategies have been proposed to redesign the continuous-time controller such in [Keller & Anderson 1992].

For the linear systems case, the sampled-data design analysis is easier and makes reference either to the controller discretization issues [Franklin *et al.* 1998] or to optimizing procedures for designing digital controllers [Chen & Francis 1995].

- B. **Discrete-Time Design (DTD)** - The control design is performed on the discrete-time equivalent model of the continuous-time process. In this case, the design neglects the inter-sample behavior of the system that may be critical in some situations. If in a linear context there is no problem to apply such method, in the nonlinear case the exact computation of the discrete time models becomes intractable.

Another drawback is that through the sampling procedure, continuous-time properties are generally lost. As an example, some particular structures of a system (e.g. the input-affine, strict-feedback, feedforward or singularly perturbed form [Barbot *et al.* 1996] and others) are no longer preserved under sampling and hence more general discrete-time control methodologies have to be applied. As a consequence, basic structural properties are lost, under the sampling, such as passivity [Tiefensee *et al.* 2010b], [Tiefensee 2010], stability or optimality [Monaco & Normand-Cyrot 2012]. The difficulties are well known and documented in the linear context, for example the occurrence of critical zeros, the matter of influence of the sampling rate's amplitude and the matter of approximation calculus [Monaco & Normand-Cyrot 1983], [Aström *et al.* 1984], [Goodwin *et al.* 2010].

Now let there be considered the case when there exists a valid sampled equivalent of the continuous-time system. In this case, in the last three decades notable progresses have been done in designing direct digital controllers for the nonlinear discrete-time systems and for a number of issues related to observability, controllability, invariance, decoupling, regulation and so on ([Normand-Cyrot 1982, Monaco & Normand-Cyrot 1984a, Monaco & Normand-Cyrot 1984c], [Monaco & Normand-Cyrot 1984b] and the references from [Monaco & Normand-Cyrot 2007]). In this area a practical issue is based on the approximation of the sampled-data model on the

basis of which a digital control is designed. The most commonly used is the Euler approximation for its simplicity. The stabilizing properties of the controller designed from these approximations are at most semiglobal and guarantee a “practical” stabilization of the sampled-data system [Nešić & Teel 2006]. In [Nešić *et al.* 1999] there are developed some examples that illustrate the fact that in some situations a controller that stabilizes an approximated Euler model fails when it is applied on the sampled-data system.

Other solutions proposed handle with higher approximations of the model [Nešić *et al.* 1999], [Nešić & Teel 2004a], [Comeau & Hori 1998] or other digital redesigns procedures [Ieko *et al.* 1996]. In this context, it is interesting to note that the stability properties can be guaranteed not only by choosing the sampling period, but also by choosing a small enough integration step, that determines the accuracy of the discrete model.

In conclusion, the **DTD** methods can offer larger attraction domains and implicitly larger sampling periods. A remaining problem is linked to the inter-sample behavior which is totally ignored.

- c. **Sampled-Data Design (SDD)** - In this case the digital controller is designed from the sampled equivalent model of the continuous-time process, taking the advantage of its dependency in the sampling period parameter. The controller is function of the continuous-time variables that are sampled at each periodic instant. In this way, this approach can handle the problem of inter-sampling behavior. The sampled-data model has specific properties and it is described by its series expansion in terms of the sampling rate. An important statement is the following: the sampled models are described by asymptotic series depending on the sampling rate, the digital controller solution admits itself series expansion which is defined around the continuous-time law. Other significant aspects are: how to maintain the continuous-time performance in discrete time through sampling and what is the proper value of the sampling rate.

The **SDD** approach handles both continuous and discrete-time behaviors and its representation in the control literature is rather scarce compared with the others approaches previously recalled. For the linear case the best results are summarized in [Chen & Francis 1995]. The major advantage of this approach compared with **CTD** or **DTD** is that it permits, at the theoretical and fundamental level, to propose digital controllers that reproduce continuous-time properties under samplings [Monaco & Normand-Cyrot 2006], [Monaco & Normand-Cyrot 2009]. In the **SDD** there are possible two design scenarios. The first, that is called “indirect-design”, is based on an a priori continuous-time solution that was designed with certain performance. The digital controller is designed around the continuous-time law as an exponential series parametrized by the

sampling period. In this way, it is possible to impose reproduction objectives of the continuous-time behavior (said ideal case) such as: input-state [Monaco & Normand-Cyrot 2006], input-output [Fromion *et al.* 1996], input- Lyapunov stability [Fromion *et al.* 1996],[Nešić & Grüne 2005], [Monaco *et al.* 2009, Monaco *et al.* 2010]. The second scenario called “direct-design” is referred to when a continuous-time law does not exist or is not computable. Then a digital controller is designed, from the sampled-data model, by imposing digital performance objectives by means of strategies such as: dead-beat, discrete Lyapunov stabilization, discrete passivity as in [Tiefensee 2010]. On this type of systems, some results were obtained with the SDD approach in [Gennaro 2002], [Di Giamberardino *et al.* 2002], [Monaco & Normand-Cyrot 2001].

A possible question arises from the fact that nowadays the acquisition and sampling devices are performing for very small sampling periods, why insist on such methods as SDD or DTD should be useless ? Three counter arguments can be observed. First, besides the fact that fast sampling allow more precise and accurate recovery of the continuous-time controllers objectives, the quantization errors and numerical or physical noises induce, in this case of fast sampling, more complex detrimental performance effects. Second, as it was pointed out previously, there are situations when continuous-time solutions do not exist, and the only solution is to propose a digital design. Third, these techniques are performing better no matter if the sampling rate is fast enough.

In the last decade the interest for network control systems has increased exponentially (see for example references from [Antsaklis & Baillieul 2004] or [Bemporad *et al.* 2010]) and has driven new applications for sampled-data systems. The particular case of interest is when the control loop components are available in a network. The controller is connected to the actuators and sensors through communication channels with finite informational capacity. The problems addressed in this emerging area of information theory, computer networks and control are often discussed in a linear context and fewer works are addressing the nonlinear case. Among these, some works have been dedicated to issues such as the variable communication delays [Niculescu & Gu 2004],[Karafyllis & Krstic 2011], limited channel capacity, quantized feedback [Kameneva & Nešić 2010] or disturbance inputs [Nešić & Teel 2004b]. This area has an increased potential for new results which are mandatory for this new age of the network systems.

The present thesis concerns the SDD approach. It is based on sampled data control strategies and on solutions developed in the references [Monaco & Normand-Cyrot 2001, Monaco & Normand-Cyrot 2007], [Monaco & Normand-Cyrot 2009]. The goal of this present work is to develop computational tools in a dedicated toolbox, for the design and computation of improved digital controllers: the core of this thesis.

1.2 CAD TOOLS IN NONLINEAR CONTROL

The extensive use of symbolic calculus in the last two decades has generated a lot of software tools for the design and analysis of control systems. By including numerical algorithms and the features of the computer graphical interface, many computer-aided design control toolboxes Computer Aided Design Control (CADC) were developed. These software applications prove to be useful in the educational, research or industrial activities in order to avoid complex algebraical/numerical manipulations and to lead to new technological developments.

In the control area, these CADC software applications are specific to the type of system dynamics and to the type of the control design strategy. These toolboxes are widely developed for linear continuous and discrete-time system dynamics and most of them are designed by using numerical algorithms. These packages cover the most well-known control strategies, ranging from simple SISO system design tools to a variety of methodologies such as: optimal, robust, adaptive, model predictive control etc. With reference to the computational aspects, the main advantage of linear dynamics is dealing with matrix algebra for which numerous efficient toolboxes exist. In the nonlinear context, the situation is very different because the nonlinearity involves the composition of functions instead of matrix operations as an elementary example.

For the analysis and design of nonlinear control systems, differential geometry provides a useful mathematical framework. The differential geometric objects (e.g. Lie derivatives and brackets, manifolds, etc) can be handled more intuitively with symbolic tools. In this way, the solutions for nonlinear control problems can be computed exactly with no possibility of accumulation of quantization error as is often the case in the numerical algorithms.

Ad hoc computational tools have been built for computing nonlinear control strategies. Several examples, which are developed with symbolic tools, can be mentioned: MACSYMA -developed by MIT beginning in the '60s [Eldeib & Tsai 1988]; CONDENS [Akhrif & Blankenship 1988], NonLinCon by Bram de Jager [de Jager 1995], NelinSys by Martin Ondera ¹ and many other tools that handle with exact linearization, asymptotic output tracking and others. A similar application, QEPCAD, is dedicated to similar problems but using quantifier elimination strategy [Jirstrand 1997]. Other symbolic nonlinear systems CAD applications can be mentioned such as: NLFeedback [Rodrigues-Millan *et al.* 1997] or CAD System for Nonlinear Control by T. Othani [Ohtani *et al.* 1994] are handling the design of nonlinear observers. Each university, research institute or industrial entity prefers to develop their own CADC software applications which remain locally available. Most of these applications are based on powerful symbolic and numerical tools provided by technical programming and developing envi-

¹ <http://www.mathworks.com/matlabcentral/fileexchange/authors/18800>

ronments such as Matlab, Maple or Mathematica. The analytical expressions of these control solutions generally involve Lie algebraic tools, for instance the Lie derivative operator which generalizes, for the nonlinear context, the notion of matrix - a finite dimensional linear operator- and the notion of the Lie series instead of an exponential of the matrix.

The software developed in this thesis makes reference to the input-output matching control strategy proposed in [Monaco & Normand-Cyrot 2007] and further developed in [Monaco *et al.* 2011], [Monaco & Normand-Cyrot 2009]. The efficiency of these techniques revealed through simulation of academic up to realistic examples justifies the need to develop an ad hoc software. The basic idea is as follows:

Given a continuous-time system described by ordinary differential equations and smooth vector fields functions, given also a continuous-time controller designed to satisfy control objectives on a certain output mapping, assume that the control is kept constant over time intervals of constant length and find the digital controller, so that its performance on the system be the same as those of the ideal continuous-time strategy. This coincidence is requested at the sampling instants. Such a problem is referred to as the input-output matching under digital control. Solutions have been proposed thanks to the Lie series expansions and combinatorial calculus. It is clear the combinatorial and iterative character of these solutions which suggests the development of an ad hoc software makes use of formal calculus tools.

In this thesis, the attention is not restricted to SISO systems but considers also the MIMO systems. The existence of complete solutions relies on the relative degree index, which is the extension to the nonlinear case of the excess of poles over the zeros in the linear context. The notion of input/output link might be understood as the privileged target link to be controlled. In fact, when Lyapunov-based design procedures are considered, such a privileged link corresponds to the input/Lyapunov link. In the context of optimality, such a privileged link corresponds to the input/criteria link associated with some energy or suitable criteria function. The complete software will include different modules providing digital versions of the well-developed backstepping, optimal or energy-shaping techniques based on passivity properties of suitably defined input/output links.

With reference to CADC applications for sampled-data systems, there are some tools developed for linear dynamics. Here it can be mentioned the DirectSD [Polyakov *et al.* 2006] application based on parametric transfer function methods, [Fujioka *et al.* 1999] by using object oriented programming or [Oshima *et al.* 1991]. To my best knowledge, there is no CAD tool for nonlinear sampled-data systems comparable with SimNLSys.

1.3 NOTATIONS AND MATHEMATICAL ASPECTS

We note that these mathematical recalls are voluntarily in a simple way to prevent from extra difficulties and to track on the manipulations which are essential to understand the thesis contributions. Some specific conditions, which can be restrictive, have been formulated for general properties and definition (e.g. smoothness, forward-complete, input-affine) that can be relaxed when considering examples or practical applications.

The next notations, definitions and properties are recalled from the actual literature, mainly from [Isidori 1995], [Sepulchre *et al.* 1997], [Khalil 1996] or [Monaco & Normand-Cyrot 2007].

1.3.1 The class of systems

Through this work it is mainly considered the **SISO** input-affine continuous-time system:

$$\dot{x}_c(t) = f(x_c(t)) + u(t, x_c(t))g(x_c(t)) \quad (1.1)$$

$$y_c(t) = h(x_c(t)) \quad (1.2)$$

where

$x \in \mathbb{R}^n$ - represents the systems state;

$t \in \mathbb{R}, u \in \mathbb{R}$ - represents time and one-input respectively ;

$f, g : \mathbb{R}^n \rightarrow \mathbb{R}^n$ are vector fields and $h : \mathbb{R}^n \rightarrow \mathbb{R}$ an analytic functions. ² The vector fields are assumed smooth (or of class C^∞), except when it is differently specified. Another assumption is that the continuous control system (1.2) is considered forward complete ³(it does not exhibit finite escape time under bounded and measurable inputs).

When it is considered an external state-feedback controller u_c given by (1.3), then the closed loop system is described by (1.5):

$$u_c(t) = \alpha(x_c(t)) + v(t)\beta(x_c(t)) \quad (1.3)$$

$$\dot{\tilde{x}}_c(t) = (f + \alpha g)(\tilde{x}_c(t)) + v(t)\beta g(\tilde{x}_c(t)) \quad (1.4)$$

$$\tilde{y}_c(t) = h(\tilde{x}_c(t)) \quad (1.5)$$

with $\alpha(\cdot), \beta(\cdot)$ as smooth functions and $v(t)$ as an external time-signal.

² An analytic function is a function that is locally given by a convergent power series. Also, an analytic function is an infinitely differentiable function such that the Taylor series at any point x_0 in its domain converges to $f(x)$ for x in a neighborhood of x_0 .

³ By denoting \mathcal{U}_m the space of measurable and locally bounded control input functions u , then a system (1.2) is *forward complete* if for $\forall x_0 \in \mathbb{R}^n, u \in \mathcal{U}_m$ the solution $x(x(0), t)$ of (1.2) corresponding to input u exists $\forall t \geq 0$.

1.3.2 Vector fields

Let there be $f : U \rightarrow \mathbb{R}^n$ a smooth map (class C^∞), where U is an open set contained in \mathbb{R}^n .

- The f map associates for each x point from U a vector in the \mathbb{R}^n i.e. $f(x)$ and it is called *vector field* over set U .
- In other words, the map f associates each point x of U to a vector with the origin in x and the top in $x + f(x)$.

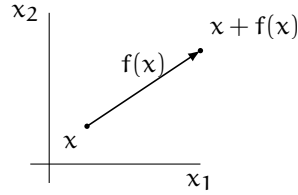

1.3.3 Lie derivative

The Lie derivative associated with a vector field is an operator that evaluates the direction in which an function changes over this vector field. Let us define the formal operator *Lie derivative* associated to a vector field f , as L_f :

$$L_f = \sum_i^n f_i \frac{\partial}{\partial x_i} \quad (1.6)$$

The Lie derivative of a smooth function h with the respect to the vector field f , evaluated in a point x is given by:

$$L_f h|_x = \sum_i^n \frac{\partial h}{\partial x_i} |_x f_i(x) \quad (1.7)$$

Another form to represent (1.5) is : $L_f h|_x = \text{jacobian}(h)|_x f(x) = Jh(f)|_x$

If $h(x)=\text{Id}$ (identity function), then $L_f \text{Id}|_x = f(x)$.

Some properties of the Lie derivative are given next.

1. The Lie derivative is a linear operator. If there are $\alpha_1, \alpha_2 \in \mathbb{R}$ and $h_1, h_2 : \mathbb{R}^n \rightarrow \mathbb{R}$ then

$$L_f(\alpha_1 h_1 + \alpha_2 h_2) = \alpha_1 L_f h_1 + \alpha_2 L_f h_2 \quad (1.8)$$

2. The iterative composition of the two Lie operators.

$$L_g \circ L_f h|_x = \frac{\partial L_f h}{\partial x} |_x \cdot g(x) \quad (1.9)$$

3. The Lie bracket product is still a Lie operator :

$$[f, g] = \text{ad}_{fg}; \quad (1.10)$$

Remark: $[f, g] = -[g, f]$, with

$$L_{[f, g]}h := L_f \circ L_g h - L_g \circ L_f h = Jh(fg) \quad (1.11)$$

Iterative Lie bracket is defined as follows:

$$\text{ad}_{fg}^p = [f, \text{ad}_{fg}^{p-1}]; \text{ad}_{fg}^0 = g. \quad (1.12)$$

4. Lie exponential operator

$$e^{L_f} = 1 + \sum_{p \geq 1} \frac{1}{p!} L_f^p \quad (1.13)$$

with 1 the identity operator, respectively applied on a map h ,

$$e^{L_f} h|_x = h(x) + \sum_{p \geq 1} \frac{1}{p!} L_f^p h|_x = e^f h|_x = h(e^f(x)) \quad (1.14)$$

Remarks:

- The composition “ \circ ” is not commutative: $L_g \circ L_f \neq L_f \circ L_g$
- $L_f^n = L_f \circ L_f^{n-1} = L_f^{n-1} \circ L_f$
- $L_f^0 = 1$ (identity operator)
- By notation abuse, we use sometimes e^f in place of e^{L_f} .

1.3.4 Comparison functions

The use of comparison functions are useful when showing results on the Lyapunov stability. The next definitions are recalled from [Khalil 1996].

Definition 7. A continuous function $\alpha : [0, a) \rightarrow [0, \infty)$ is said to belong to class \mathcal{K} if it is strictly increasing and $\alpha(0) = 0$. It is said to belong to class \mathcal{K}_∞ if $a = \infty$ and $\alpha(r) \rightarrow \infty$ as $s \rightarrow \infty$.

Definition 8. A continuous function $\beta : [0, a) \times [0, \infty) \rightarrow [0, \infty)$ is said to belong to class \mathcal{KL} if, for each s fixed, the mapping $\beta(r, s)$ belongs to class \mathcal{K} with respect to r and, for each r fixed, the mappings $\beta(r, s)$ is decreasing with respect to s and $\beta(r, s) \rightarrow 0$ as $r \rightarrow \infty$.

Some examples:

- $\alpha(r) = \tan^{-1}(r) \in \mathcal{K}$ but not in \mathcal{K}_∞ ;
- $\alpha(r) = r^c \in \mathcal{K}_\infty$, with any positive real scalar c ;
- $\beta(r, s) = \frac{r}{ksr+1} \in \mathcal{KL}$, for any positive real k ;
- $\beta(r, s) = r^c e^{-s} \in \mathcal{KL}$, for any positive real c .

Proposition 9. $O(\delta^p)$ property

A function $R(x, \delta)$, with $\delta < 1$ is of p order in δ , e.g. $O(\delta^p)$, if whenever R is defined then it can be written as $R(x, \delta) = \delta^p \tilde{R}(x, \delta)$ and there is a function $\psi \in \mathcal{K}_\infty$ such that for each $\Delta > 0$ there is $\delta^* > 0$ such that $|x| \leq \Delta$ and $\delta < \delta^*$ implies $|\tilde{R}(x, \delta)| \leq \psi(|x|)$.

1.3.5 Relative degree

The relative degree is a concept that illustrates how the output depends on the input values along time. For the linear case, this corresponds to the notion of the poles excess over zeros of the transfer function.

Definition 10. [Isidori 1995] The system (1.2) has relative degree $r \in \{1, \dots, l\}$ at $x^0 \in \mathbb{R}^n$ if, and only if, there exists an open neighborhood \mathcal{U} of x_0 , such that,

$$\begin{aligned} \text{(i)} \quad & \forall x \in \mathcal{U} \quad \forall k \in \{0, 1, \dots, r-2\}: L_g L_f^k h(x) = 0 \\ \text{(ii)} \quad & L_g L_f^{r-1} h(x_0) \neq 0 \end{aligned} .$$

The previous definition represents a local version formulation. In a global definition, the degree relative is called *uniform*, if the above conditions hold for any $x_0 \in \mathbb{R}^n$.

1.3.6 BCH exponent

The m order Baker-Campbell Hausdorff exponent noted as $\text{BCH}^{m(\cdot)}$ represents the exponent series of the non-commutative composition of m exponential series. For $m = 2$ then $\text{BCH}^2(X, Y)$ can be computed as

$$e^X \circ e^Y = e^{\text{BCH}^2(X, Y)} = e^{X+Y + \frac{1}{2}[X, Y] + \frac{1}{12}([X, [X, Y]] + [Y, [Y, X]])} + \dots \quad (1.15)$$

Further details can be found also in [Monaco et al. 2007].

1.3.7 Sampled-data systems

A sampled-data control system represents a control scheme where the continuous-time plant is driven by a digital controller. Under sampling, the sampled-data system is continuous-time varying and it can be modeled by its discrete-time model obtained through discretization. This discrete-time model does not take into account the inter-sample behavior of the real system, which may be critical for many applications.

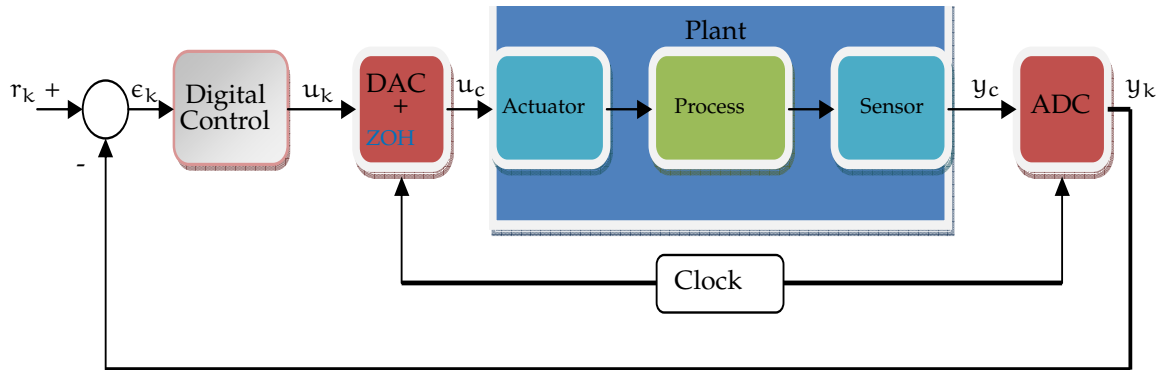

Figure 1.1: Sampled data control scheme

In Figure 1.1 a schematic representation of a sampled-data system is depicted. It consists of a physical process connected to a control structure through sensors and actuators by means of digital to analog and analog to digital converters. The discrete signals (measures and controls) are processed by a computer device according to the reference/objectives imposed. The digital controller can be build as a state-feedback control law or as an output-reference control law.

To compute the closed-loop system solutions (e.g. state, output evolutions) two approaches are usually used: a numerical or a functional approach. Both approaches give, after explicit calculus, approximations of the “true” solutions. The functional way is more suitable for theoretical studies and development because the expressions have a mathematical meaning and some properties can be understood. The numerical approach is suitable for computer calculus because it gives faster computations.

1.3.7.1 Functional expansions

The functional expansions of the sampled data systems are based, in this work, on the Lie tools previously introduced. Let us consider the system Σ_c given by (1.2) and assume that the control is

constant over time intervals of amplitude δ (which is also referred to as the sampling period in this work):

$$\mathbf{u}(t, \mathbf{x}_c(t)) = \underline{\mathbf{u}}(k) = \mathbf{u}(k\delta, \mathbf{x}_c(k\delta)), \text{ for each } t \in [k\delta, (k+1)\delta), k > 0 \quad (1.16)$$

For this system, the discrete-time state-space equivalent representation is:

$$\mathbf{x}_d(k+1) = F^\delta(\mathbf{x}_d(k), \underline{\mathbf{u}}(k)) \quad (1.17)$$

$$\mathbf{y}_d(k) = \mathbf{h}(\mathbf{x}_d(k)) \quad (1.18)$$

where $F^\delta : \mathbb{R}^m \rightarrow \mathbb{R}^n$ is characterized by the following exponential expansion:

$$F^\delta(\bullet, \underline{\mathbf{u}}(k)) = e^{\delta L_{\tilde{f}}} I_d(\bullet) \quad (1.19)$$

with $\tilde{f}(x) = f(x) + \underline{\mathbf{u}}(k)g(x)$ and I_d identity operator.

Remark 11. For the same initial conditions, the system Σ_d is the exact sampled equivalent of the system Σ_c . In other words these systems have the same input-state at the sampling instants $t = k\delta$:

$$\mathbf{x}_c(k\delta) = \mathbf{x}_d(k)$$

The expansion of (1.18) could be performed either in power of δ or $\underline{\mathbf{u}}$. If it is considered with respect to δ , then let us introduce the notion of the approximated sampling at the p -order.

$$e^{L_{\tilde{f}}} I_d|_{\mathbf{x}_d(k)} = e^{\delta L_{\tilde{f}}}(\mathbf{x}_d(k)) = (1 + \delta L_{\tilde{f}} + \frac{\delta^2}{2!} L_{\tilde{f}}^2 + \dots + \frac{\delta^p}{p!} L_{\tilde{f}}^p)(\mathbf{x}_d(k)) + O(\delta^{p+1}) \quad (1.20)$$

where $O(\delta^{p+1})$ contains the remaining terms of order greater than p in δ . The first order approximation, of this series, is also referred to as the *Euler approximation*:

$$\mathbf{x}_d(k+1) = \mathbf{x}_d(k) + \delta \tilde{f}(k) \quad (1.21)$$

When the sampled data equivalent dynamics is described by a finite number of terms i.e. there exists $P \geq 1$ such that

$$e^{L_{\tilde{f}}} I_d|_{\mathbf{x}_d(k)} = (1 + \delta L_{\tilde{f}} + \frac{\delta^2}{2!} L_{\tilde{f}}^2 + \dots + \frac{\delta^P}{P!} L_{\tilde{f}}^P)(\mathbf{x}_d(k))$$

we speak about *finite discretizability* of dynamics (1.18).

In this thesis, the solutions that are proposed are analyzed formally and no convergence studies are conducted.

An easy example is given in section 1.3.8 for computing the exponential expansion of the discrete solution.

1.3.7.2 Numerical integrations

In this subsection, there are recalled some basic elements useful for integrating numerically the solutions of the sampled-data systems. Numerical approach is suitable when using computer systems especially for simulations of the control structures. The Runge-Kutta (RK) [Dormand & P.J.Prince 1980] methods are widely used for computing the solutions of ordinary differential equations.

RUNGE KUTTA Let us consider an initial value problem as follows:

$$\dot{y} = f(t, y), y(t_0) = y_0$$

The usual method to solve this differential equation is the RK4 (Runge-Kutta of order 4). The solution is given by the following equations:

$$\begin{aligned} y_{n+1} &= y_n + \frac{1}{6}d(k_1 + 2k_2 + 2k_3 + k_4) \\ t_{n+1} &= t_n + d \end{aligned}$$

where

$$\begin{aligned} k_1 &= f(t_n, y_n) \\ k_2 &= f\left(t_n + \frac{1}{2}d, y_n + \frac{1}{2}dk_1\right) \\ k_3 &= f\left(t_n + \frac{1}{2}d, y_n + \frac{1}{2}dk_2\right) \\ k_4 &= f(t_n + d, y_n + dk_3) \end{aligned}$$

with d as the integration step. For an accurate solution one should chose a small enough value of d .

A more general representation of the RK4 method is given by the family of the explicit Runge-Kutta, that is given below:

$$y_{n+1} = y_n + d \sum_{i=1}^s b_i k_i,$$

where

$$\begin{aligned} k_1 &= f(t_n, y_n), \\ k_2 &= f(t_n + c_2h, y_n + a_{21}hk_1), \\ k_3 &= f(t_n + c_3h, y_n + a_{31}hk_1 + a_{32}hk_2), \\ &\vdots \\ k_s &= f(t_n + c_sh, y_n + a_{s1}hk_1 + a_{s2}hk_2 + \cdots + a_{s,s-1}hk_{s-1}). \end{aligned}$$

For a compact view, the Butcher tableau representation is preferred as depicted in Table 1.1 with the consistency condition: $\sum_{j=1}^{i-1} a_{ij} = c_i$ for $i = 2, \dots, s$.

0					
c_2	a_{21}				
c_3	a_{31}	a_{32}			
\vdots	\vdots		\ddots		
c_s	a_{s1}	a_{s2}	\cdots	$a_{s,s-1}$	
	b_1	b_2	\cdots	b_{s-1}	b_s

Table 1.1: Butcher Tableau

0							
1/5	1/5						
3/10	3/40	9/40					
4/5	44/45	-56/15	32/9				
19372/6561	-25360/2187	64448/6561	-212/729				
1	9017/3168	-355/33	46732/5247	49/176	-5103/18656		
1	35/384	0	500/1113	125/192	-2187/6784	11/84	
	5179/57600	0	7571/16695	393/640	-92097/339200	187/2100	1/40
	35/384	0	500/1113	125/192	-2187/6784	11/84	0

Table 1.2: Butcher Tableau DP5

ADAPTIVE RUNGE KUTTA. Another class of RK methods is represented by the adaptive methods. These methods compute a local estimation error for each step. To do this, it is necessary to compute two solutions: one of p -order denoted by (y_{n+1}) and the other of $p - 1$ order denoted by (y_{n+1}^*) order, and the error estimation is the difference between these.

$$e_{n+1} = y_{n+1} - y_{n+1}^* = d \sum_{i=1}^s (b_i - b_i^*) k_i, \quad (1.22)$$

In Matlab (Simulink) the default algorithm used for the integration is Dormand-Prince of 5th order with variable integration step. The Butcher Tableau is given in Table 1.2.

There are two rows of d coefficients, the first row is for the fourth order solution and the second for the fifth order. These rows can give the error estimation to make possible the adaptation of the size of the d parameter. By considering large amount of data, if a small value for d is chosen, the simulation time is larger and the accuracy could be significantly the same with the one obtained with a bigger d . This is the reason this method is more efficient since it handles with two objectives: reduced time

and accuracy solving. The proposed solution adapts the size of the δ parameter, at each step, and consequently the best results in terms of speed and precision of the solution are obtained.

1.3.8 Example 1.

In this section there are given some Lie computation examples when dealing with sampled-data systems. The objective is to compute the discrete-time equivalent for a SISO nonlinear system in different particular situations.

Let there be considered the following continuous-time system:

$$\begin{aligned}\dot{x}_1(t) &= 5x_1^2(t) + x_2(t) \\ \dot{x}_2(t) &= 3x_2^2(t) + \cos(x_1(t)) + u(t) \\ y(t) &= x_1(t) + 2x_2(t)\end{aligned}\tag{1.23}$$

The problem is to find the mathematical expressions of the discrete-time equivalent and of the sampled output of the system (1.23) in closed loop, when:

1. $u(t) = -\cos(x_1(t)) - 3x_2^2(t) - 3(x_1(t) + x_2(t))$;
2. $u(t) = -t\sin(t)$;
3. $u(t) = -\cos(x_1(t)) - 3x_2^2(t) - 3(x_1(t) + x_2(t))$, is kept constant over $t \in [k\delta, (k+1)\delta)$?

Solution

Let us consider the notations given in the previous sections. The system (1.23) is affine-input with:

$$f = \begin{bmatrix} 5x_1^2 + x_2 \\ 3x_2 + \cos(x_1) \end{bmatrix}; \quad g = \begin{bmatrix} 0 \\ 1 \end{bmatrix}; \quad h(x) = x_1 + 2x_2$$

By using the expansion (1.20) one gets:

- i) when u is in continuous-time evolution (the above cases 1 and 2):

$$\begin{aligned}x_{k+1} &= x_k + \delta L_{f+ug}(x_k) + \frac{\delta^2}{2!} L_{f+ug}^2(x_k) + \sum_{i \geq 3} \frac{\delta^i}{i!} L_{f+ug}^i(x_k) \\ &= x_k + \delta(L_f + uL_g)(x_k) + \frac{\delta^2}{2!} (L_f^2 + u^2 L_g^2 + u(L_f L_g + L_g L_f) + \dot{u} L_g)(x_k) \\ &+ O(\delta^3)\end{aligned}\tag{1.24}$$

ii) when u is kept constant over the sampling interval (the above cases 3)⁴:

$$\begin{aligned} x_{k+1}^s &= x_k^s + \delta (L_f(x_k^s) + u_k(x_k^s)L_g(x_k^s)) \\ &+ \frac{\delta^2}{2!} \left(L_f^2(x_k^s) + u_k(x_k^s)^2 L_g^2 + u_k(x_k^s)(L_f L_g + L_g L_f)(x_k^s) \right) + O(\delta^3) \end{aligned} \quad (1.25)$$

The main difference between i) and ii) is that the higher order derivatives of u are equal to 0.

Let us now compute the Lie terms involved in the previous equations:

$$\begin{aligned} L_f(x_k) &= f(x_k) = [5x_{1k}^2 + x_{2k}, 3x_{2k} + \cos(x_{1k})]^T; \quad L_g(x_k) = g(x_k) = [0, 1]^T; \\ L_f^2(x_k) &= \begin{bmatrix} 10x_{1k}(x_{1k}^2 + x_{2k}) + 3x_{2k} + \cos(x_{1k}) \\ -(5x_{1k}^2 + x_{2k})\sin(x_{1k}) + 6(3x_{2k}^3 + x_{2k}\cos(x_{1k})) \end{bmatrix}; \quad L_g^2(x_k) = 0; \\ L_g L_f(x_k) &= [1 \ 6x_{2k}]^T; \quad L_f L_g = [0 \ 0]^T. \end{aligned}$$

The states evolution of the continuous-time plant, evaluated at each integration step with an error in $O(\delta^2)$, is given by the expression (1.24) for the continuous-time controller, and the expression (1.25) for digital controller respectively, with the operators defined above. The inputs are also evaluated at each sampling instants, e.g.

1.

$$u = u(x_k) = -\cos(x_{1k}) - 3x_{2k}^2 - 3(x_{1k} + x_{2k}); \quad (1.26)$$

$$\dot{u} = \dot{u}(x(t))|_{t=k\delta} = (3x_{1k} + 3x_{2k})(6x_{2k} + 3) + (5x_{1k}^2 + x_{2k})(\sin(x_{1k}) - 3) \quad (1.27)$$

2.

$$u = u(k\delta) = -k\delta \sin(k\delta); \quad (1.28)$$

$$\dot{u} = \dot{u}(t)|_{t=k\delta} = -\sin(k\delta) - t \cos(k\delta) \quad (1.29)$$

3.

$$u_k = u(x_k^s) = -\cos(x_{1k}^s) - 3x_{2k}^s{}^2 - 3(x_{1k}^s + x_{2k}^s) \quad (1.30)$$

In a similar way the sampled-output can be evaluated for the above cases.

i) when control u is in continuous-time evolution:

$$\begin{aligned} y((k+1)\delta) &= h(x_{k+1}) = h(x_k) + \delta(L_f + uL_g)h(x_k) \\ &+ \frac{\delta^2}{2!} \left(L_f^2 + u^2 L_g^2 + u(L_f L_g + L_g L_f) + \dot{u}L_g \right) h(x_k) + O(\delta^3) \end{aligned} \quad (1.31)$$

⁴ The "s" subscript stand for the sampled evolution in the case of digital controllers

ii) when control u is kept constant:

$$\begin{aligned} y_s((k+1)\delta) &= h(x_{k+1}^s) = h(x_k^s) + \delta(L_f + u_k L_g)h(x_k^s) \\ &+ \frac{\delta^2}{2!} \left(L_f^2 + u_k^2 L_g^2 + u_k(L_f L_g + L_g L_f) \right) h(x_k^s) + O(\delta^3) \end{aligned} \quad (1.32)$$

The Lie derivatives involved in the previous equation are computed as follows:

$$\begin{aligned} L_f h(x_k) &= 5x_{1k}^2 + 7x_{2k} + \cos(x_{1k}); \quad L_g h(x_k) = 2; \\ L_f^2 h(x_k) &= (10x_{1k} - \sin(x_{1k}))(5x_{1k}^2 + x_{2k}) + 21x_{2k} + 7\cos(x_{1k}); \quad L_g^2 h(x_k) = 0; \\ L_g L_f(x_k) &= 7; \quad L_f L_g = 0. \end{aligned}$$

The sampled-data output computation is completely defined by the equation (1.31) with the above Lie derivatives expression and with the control expressed as in (1.27)-(1.29) in the case of continuous-time controller.

In a similar way, for the sampled-data case, the output is completely defined by the equation (1.32), by neglecting the higher derivatives of the input and where the control input is defined by the equation (1.30).

1.3.8.1 Comparative simulations

The aim of this paragraph is to provide comparative simulations between these two approaches recalled in the previous sections on the above example. A series of simulations have been performed when considering the followings integration scenarios:

- **RK45** - numerical method with adaptive integration step;
- **Ord1** - functional method, when the series expansion are truncated at first order in δ , commonly known as *Euler approximation*;
- **Ord2** - functional method with a second order series approximation;
- **Ord3** - functional method with a third order series approximation;

These scenarios have been considered for the system (1.23) when the controller is either in continuous time evolution (the case 1) or it is kept constant along the sampling interval (case 3). The results are given in Figure 1.2a and Figure 1.2b respectively .

The values of the simulation parameters are specified in Table 1.3.

To quantify the error levels between the solutions computed by the RK45 and the functional methods, two error criteria were used, which are defined in the Section 5.2.4. The results show that the higher orders of the functional methods offers solutions that are closer to the RK45 method.

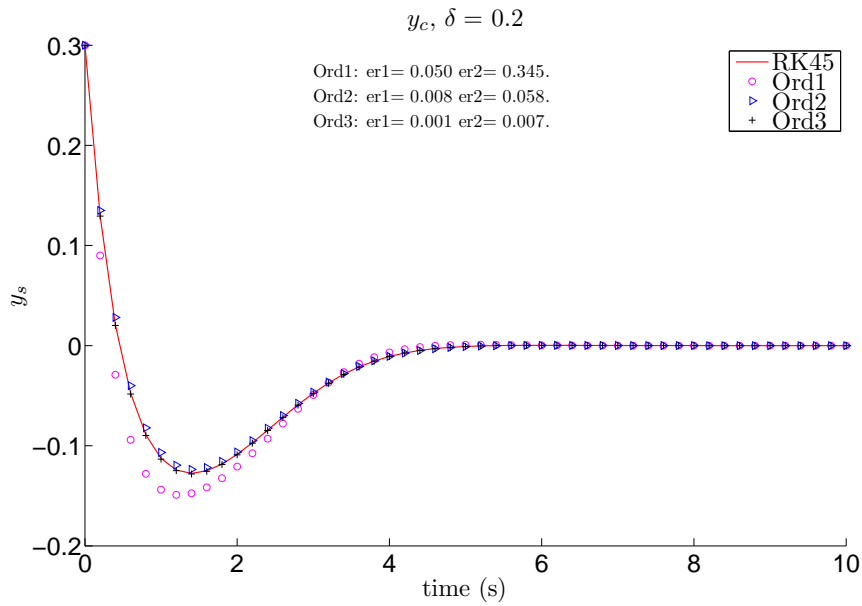

(a) Sampled-output evolution when the control is continuous

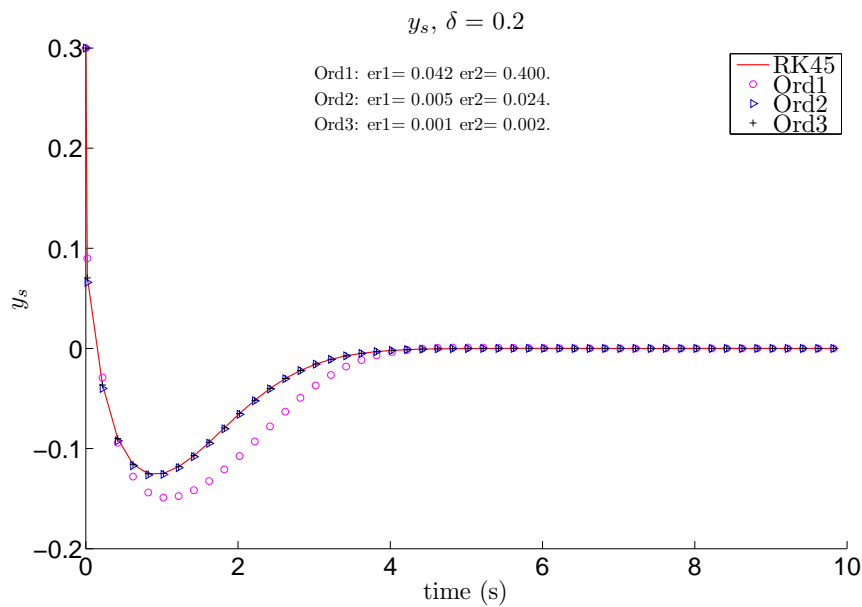

(b) Sampled-output evolution when the control is kept constant

Figure 1.2: Comparative integration algorithms when computing the sampled-output evolution

sampling period	initial condition	simulation time length
$\delta = 0.2 \text{ s}$	$x_0 = [0.1 \ 0.1]$	$t_f = 10 \text{ s}$

Table 1.3: Numerical values of the simulation parameters - Example 1

A wider discussion about which of the solution can be employed can be addressed and is not the aim of this section. The practice shows that the widely used procedure is represented by the RK45 method; the functional methods can be used when exact computations can be obtained. In some situations, the functional method can give a reduced number of operations, and consequently an increased speed can be obtained.

Part I

THEORETICAL DEVELOPMENTS

 LYAPUNOV STABILITY OF NONLINEAR SYSTEMS

This chapter deals with Lyapunov stability for sampled-data nonlinear systems. In the first section, the concepts of Lyapunov stability of continuous-time nonlinear systems are recalled especially from [Khalil 1996]. The same concepts are then addressed in Section 2.3 for discrete-time systems. They are used to analyze the stabilization properties of a sampled-data nonlinear system by means of the Lyapunov functions. At the end of this chapter an academic example is given to specify the stability performance of an emulated controller.

2.1 LYAPUNOV STABILITY IN CONTINUOUS-TIME

Let the nonlinear autonomous system :

$$\dot{x}(t) = f(x(t)) \quad (2.1)$$

where $f : D \rightarrow \mathbb{R}^n$ is a locally Lipschitz map¹ with a domain $D \subset \mathbb{R}^n$. Let us assume that $f(0) = 0$ and $x_e = 0$ is the equilibrium point. Also $x(0)$ denotes the initial condition.

Definition 12 (Stability in the sense of Lyapunov). *The equilibrium point $x_e = 0$ of system (2.1) is*

- *stable if, for each $\epsilon > 0$, there is $\mu = \mu(\epsilon) > 0$ such that²*

$$\|x(0)\| < \mu \Rightarrow \|x(t)\| \leq \epsilon, \quad \forall t \geq 0 \quad (2.2)$$

- *asymptotically stable if it is stable and μ can be chosen such that*

$$\|x(0)\| < \mu \Rightarrow \lim_{t \rightarrow \infty} x(t) = 0 \quad (2.3)$$

¹ A map f is locally Lipschitz if it satisfies

$$\|f(t, z) - f(t, x)\| \leq L\|z - x\|$$

for all (t, x) and $t, z \in D$, and $L > 0$

² In the subsequent sections $\|x\|$ or $|x|$ means the Euclidean norm of a vector x .

- exponentially stable if, for each c and σ - two positive constants, there is $\mu = \mu(c, \sigma) > 0$ such that

$$\|x(0)\| < \mu \Rightarrow \|x(t)\| \leq c \exp\{-\sigma t\}, \forall t \geq 0 \quad (2.4)$$

- unstable if it is not stable.

Asymptotic stability is said to hold *globally* if the convergence of the state trajectories is satisfied for any initial condition that lies in the entire definition domain (e.g. $D = \mathbb{R}^n$).

Asymptotic stability is said to hold in a *semiglobal* sense if the initial conditions are in an arbitrarily large compact set.

Exponential stability implies asymptotic stability, asymptotic stability implies stability in the sense of Lyapunov, but the reverse is not true.

Theorem 13. [Khalil 1996] *The second (or direct) method of Lyapunov*

Let $x_e = 0$ be an equilibrium point for (2.1), and $x \in D$. Let $V : D \rightarrow \mathbb{R}$ be a continuously differentiable and positive definite function

$$V(0) = 0, V(x(t)) > 0 \text{ in } D - \{0\} \quad (2.5)$$

such that

$$\dot{V}(x(t)) \leq 0, \text{ in } D \quad (2.6)$$

Then, $x = 0$ is stable. Moreover, if

$$\dot{V}(x(t)) < 0, \text{ in } D - \{0\} \quad (2.7)$$

then $x = 0$ is asymptotically stable.

A V function that satisfies the properties of the [Theorem 13](#) is called a *Lyapunov function*. The Lyapunov surface (or level) is represented by the x which satisfies $V(x) = c$, for some positive c . Condition (2.7), $\dot{V} < 0$ implies that any trajectory that enters in a set $\Omega_c = \{x \in \mathbb{R}^n | V(x) \leq c\}$ can never go out again. Also, negative definitiveness of \dot{V} assures that trajectories move from one Lyapunov surface to an inner Lyapunov surface with smaller c . As c decreases, the surface $V(x) = c$ reduces and forces the trajectories to approach to the origin as time progresses.

[Theorem 13](#) gives the condition for local stability. For global stabilization of the equilibrium, when $D = \mathbb{R}^n$, the extra condition that $V(x)$ is radially unbounded is required.

If we only know that $\dot{V}(x) \leq 0$, then it is not guaranteed that the trajectories are converging to the equilibrium point, but we can state that the origin is stable since the trajectories can be contained in a ball B_ϵ by requiring the initial state $x(0)$ to lie inside a Lyapunov surface that is included in B_ϵ .

Theorem 13 offers sufficient conditions only. If a Lyapunov function candidate fails to satisfy the previous properties this does not mean that the equilibrium is not stable but it means that the stability cannot be established with this Lyapunov function candidate. In this case further investigations are necessary. To verify if the equilibrium is unstable some instability theorems can be used, as the next one.

Theorem 14. [Sastry 1999] *General Instability Theorem*

Let there be considered the same V function as in Theorem 13 with $V(x)$ positive definite. Assume that in any subset of D , containing the origin, there is x such that $V(x) > 0$. If, moreover $\dot{V}(x) > 0$, $\forall x \neq 0$ in D then the system is unstable at the origin.

In order to refine the results of the Theorem 13 by means of comparison functions the next proposition holds.

Proposition 15. [Khalil 1996] Let assume the same condition as in Theorem 13. Let suppose that $V : D \rightarrow \mathbb{R}$ is a continuous positive definite function defined on a domain $D \subset \mathbb{R}^n$ that contains the origin. Let $B_r \subset D$ for some $r > 0$. Then, there exist class \mathcal{K} functions ρ_1, ρ_2, ρ_3 defined on B_r such that

$$\rho_1(\|x\|) \leq V(x(t)) \leq \rho_2(\|x\|) \quad (2.8)$$

$$\dot{V}(x(t)) \leq -\rho_3(\|x\|) \quad (2.9)$$

for all $x(t) \in B_r$. If $D \subset \mathbb{R}^n$, the functions ρ_1, ρ_2, ρ_3 will be defined on $[0, \infty)$ and the foregoing inequality will hold for all $x(t) \in \mathbb{R}^n$. Moreover if $V(x(t))$ is radially unbounded, then ρ_i can be chosen to belong to class \mathcal{K}_∞ .

If the conditions of Proposition 15 hold then it is shown [Khalil 1996] that there exists a \mathcal{KL} function β so that the solution of the system (2.1) satisfies

$$\|x(t, x_0)\| \leq \beta(\|x_0\|, t) \quad \forall x_0 \in B_r, t \geq 0. \quad (2.10)$$

2.1.1 The linear case

Let us consider the linear time-invariant system, with an equilibrium point in the origin.

$$\dot{x}(t) = Ax(t) \quad (2.11)$$

One way to test the stability properties of the equilibrium is given by the next Theorem, by using the Lyapunov method.

Theorem 16. [Khalil 1996] A matrix A is Hurwitz, that is $\text{Re}\lambda_i < 0$ for all eigenvalues of A , if and only if for any given positive definite symmetric matrix Q there exists a positive definite symmetric matrix P that satisfies the Lyapunov equation

$$PA + A^T P = -Q. \quad (2.12)$$

Moreover, if A is Hurwitz, then P is the unique solution of (2.12).

This Theorem is used as alternative to the computations of the eigenvalues of the matrix A . But the advantage of equation (2.12) is that it offers a way to find a Lyapunov function for any linear system with A Hurwitz.

In this case, the matrix solution P is :

$$P = \int_{t=0}^{\infty} e^{(A^T)t} Q e^{At} dt \quad (2.13)$$

2.1.1.1 Practical stability

This concept introduced in [LaSalle & Lefschetz 1961] for a system which is not necessarily stable in the Lyapunov sense but its performances are acceptable from some practical point of view, e.g. overshoots requirements, settling time, etc.

The definition, taken from [LaSalle & Lefschetz 1961], is particularized here to autonomous system and no perturbations are considered:

Definition 17. Given a compact set D containing the origin and D_0 a subset of D , and considering that $x^0 = x(x_0, t)$ is the solution of the autonomous system (2.1) then if for each x_0 in D_0 , $x(x_0, t)$ is in D for all $t \geq 0$ then the origin is said to be practically stable.

This means that the solutions that start in D_0 remain thereafter in D . The D in fact specifies the set of acceptable states (with good performances). According to [LaSalle & Lefschetz 1961] some remarks can be drawn about practical stability:

- practical stability is neither a stronger or a weaker concept of stability. For example there are solutions that are Lyapunov stable but are not practically stable. Also the converse is true, some unstable points can be considered practically stable (e.g. when the solution is oscillating near the origin).
- practical stability reveals a uniform boundedness of the solution relative to the set of initial conditions D_0 .

In the case of practical stability, the conditions do not necessary require the origin to be an equilibrium point. Extensions of this concept to other cases can be found in [Celentano 2012].

2.2 LYAPUNOV STABILITY OF CONTROLLED SYSTEMS

Let us consider again the input-affine system

$$\begin{aligned}\dot{x}(t) &= f(x(t)) + u(t)g(x(t)) \\ y(t) &= h(x(t))\end{aligned}\tag{2.14}$$

with the notations given in [Section 1.3.1](#).

There are certain systematic methods available for designing stabilizing controllers by means of Lyapunov functions. For example: backstepping, forwarding, methods based on control Lyapunov functions, L_gV controllers, optimal and passive controllers. Some of these methods also offer a systematic way to construct a Lyapunov function V when this was not previously known. A well documented literature is dedicated to construct Lyapunov functions [[Malisoff & Mazenc 2009](#)], [[Sepulchre et al. 1997](#)].

It is important to find the conditions when a feedback controller $u(t) = u(x(t))$ drives the closed loop system $\tilde{f}(x) = (f + ug)(x)$ to a stable origin. If such a controller exists then the system (2.14) is *stabilizable* at origin and $u(x(t))$ is called a *stabilizer*. In the next section the asymptotic stabilization of the closed loop is concerned.

The previous stability analysis can be applied also on the closed loop systems by making reference to the notion of Control Lyapunov Function (CLF) [[Artstein 1983](#)],[[Sontag 1983](#)].

Definition 18. A smooth positive definite, and radially unbounded function $V(x)$ is called a CLF for the system (2.14) if for all $x \neq 0$,

$$L_gV(x) = 0 \Rightarrow L_fV(x) < 0.\tag{2.15}$$

To be sure about the continuity of the stabilizer the *small control property* is needed.

Definition 19. A CLF V is said to satisfy the small control property if for each $\epsilon > 0$, we can find $\delta(\epsilon) > 0$ such that , for all $0 < \|x\| < \delta$, there exists u with $\|u\| < \epsilon$ which satisfies

$$L_fV(x) + L_gV(x)u < 0$$

These properties lead us to characterize the Lyapunov function for a controlled systems and to derive some constructive solutions like those of Sontag [[Sontag 1983](#)] or those in [[Praly et al. 1991](#)].

Let us, for example, consider the case of L_gV controllers as employed in the [Chapter 8](#). The L_gV controllers are used to provide asymptotic stability to Lyapunov stable systems or to increase the damping of an asymptotically stable system [[Bazanella et al. 1999](#)]. Firstly let us recall the ZSD property.

Definition 20. [Sepulchre et al. 1997][Zero State Detectable (ZSD)] The system (2.14) is locally zero state detectable if no solution of the uncontrolled dynamics $\dot{x}(t) = f(x(t))$ can stay in the set $Z = \{x \in \mathbb{R}^n, \text{ s.t. } h(x) = 0\}$ other than solutions $x(t)$ converging asymptotically to the zero equilibrium.

The main benefit of the ZSD property is that it gives the condition to connect the stability with the passivity property. The next theorem gives the main results involving $L_g V$ controllers.

Theorem 21. [Sepulchre et al. 1997] Let us consider the system (2.14) and let $D \subset \mathbb{R}^n$ be the set containing the origin. If there exists a Lyapunov function $V : D \rightarrow \mathbb{R}$ such that $V(0) = 0$, $V(x) > 0$ on $D - \{0\}$, $L_f V(x) \leq 0$ and (2.14) is ZSD then the control law $u = -KL_g V$ renders the origin locally asymptotically stable.

This theorem can be also stated globally. If the negativity of $L_f V$ is strictly negative, then the requirement of ZSD property is no more necessary.

2.3 LYAPUNOV STABILITY IN DISCRETE TIME

Let the non-linear autonomous discrete-time dynamics described by the difference equation

$$x_{k+1} = F(x_k) \quad (2.16)$$

where $f : D \rightarrow \mathbb{R}^n$ is a locally Lipschitz map with a domain $D \subset \mathbb{R}^n$. Let us assume without lose of generalization, that $F(x_e) = 0$ and $x_e = 0$ is the equilibrium point. Also $x(0)$ denotes the initial condition of the difference equation (2.16).

Definition 22. [Chen 2004][Stability in the sense of Lyapunov] The equilibrium point $x_e = 0$ of the dynamics (2.16) is

- stable if, for each $\epsilon > 0$, there is $\mu = \mu(\epsilon) > 0$ such that

$$\|x(0)\| < \mu \Rightarrow \|x_k\| \leq \epsilon, \forall k \in \mathcal{N} \quad (2.17)$$

- asymptotically stable if it is stable and μ can be chosen such that

$$\|x(0)\| < \mu \Rightarrow \lim_{k \rightarrow \infty} x_k = 0 \quad (2.18)$$

- exponentially stable if, for each c and σ - two positive constants, there is $\mu = \mu(c, \sigma) > 0$ such that

$$\|x(0)\| < \mu \Rightarrow \|x_k\| \leq c \exp(-\sigma k), \forall k \in \mathcal{N} \quad (2.19)$$

- unstable if it is not stable.

Now let us give the stability formulation with Lyapunov functions.

Theorem 23. [Chen 2004] *The second (or direct) method of Lyapunov*

Let $x_e = 0$ be an equilibrium point for $F(x_k)$, and $x \in D$. Let $V : D \rightarrow \mathbb{R}$ be a continuously differentiable positive definite function

$$V(0) = 0, V(x_k) > 0 \forall x_k \in D - \{0\} \quad (2.20)$$

such that

$$\Delta V(x_{k+1}) := V(x_{k+1}) - V(x_k) \leq 0, \forall x_k \in D \quad (2.21)$$

then, $x_e = 0$ is stable. Moreover, if

$$\Delta V(x_{k+1}) < 0, \text{ in } D - \{0\} \quad (2.22)$$

then $x_e = 0$ is asymptotically stable.

For the global stabilization it is required in addition the radially unbounded condition, e.g.

$$V(x_k) \rightarrow \infty \quad \text{as} \quad \|x_k\| \rightarrow \infty. \quad (2.23)$$

2.3.1 The linear case

Let us consider the linear autonomous discrete-time dynamics, with an equilibrium point at the origin.

$$x_{k+1} = Ax_k \quad (2.24)$$

One way to test the stability properties of the equilibrium is given by the Theorem below, by means of the Lyapunov method.

Theorem 24. *A matrix A is Schur stable, that is all eigenvalues of A are $|\lambda_i| < 1$, if and only if for any given positive definite symmetric matrix Q there exists a unique positive definite symmetric matrix P that satisfies the discrete-time Lyapunov equation*

$$A^T P A - P = -Q. \quad (2.25)$$

This Theorem is used as an alternative to the computations of the eigenvalues of the matrix A . The advantage of equation (2.25) is that it offers a way to find a Lyapunov function for any linear dynamics with A stable.

In this case, the matrix solution P is :

$$P = \sum_{k=0}^{\infty} (A^T)^k Q A^k. \quad (2.26)$$

For further details, related to stability in discrete-time systems, we redirect the reader to

[Halanay & Rasvan 2000].

2.4 LYAPUNOV STABILITY FOR SAMPLED-DATA SYSTEMS

Let us now consider the dynamics,

$$\dot{x}(t) = f(x(t)) + u_k g(x(t)) \quad (2.27)$$

under control input u_k piecewise constant on intervals $[k\delta, (k+1)\delta)$, with δ the sampling period and its discrete time equivalent:

$$x_{k+1} = F^\delta(x_k, u_k) \quad (2.28)$$

The stability of sampled-data systems is established by the next theorem.

Theorem 25. [Nešić et al. 1999] *The sampled-data system (2.27) is said globally asymptotically stable, i.e. there exists $\bar{\beta} \in \mathcal{KL}$ such that*

$$|x(t)| \leq \bar{\beta}(|x_0|, t), \quad \forall x_0, t \geq 0. \quad (2.29)$$

if and only if

- i) *the discrete-time equivalent system (2.28) is globally asymptotically stable, i.e. there exists $\beta \in \mathcal{KL}$ such that*

$$|x_k| \leq \beta(|x_0|, k), \quad \forall x_0, k > 0. \quad (2.30)$$

- ii) *the solutions of (2.27) are globally bounded, i.e. there exists $\gamma \in \mathcal{K}_\infty$ such that*

$$|x(t)| \leq \gamma(|x_0|), \quad \forall x_0, t \in [0, \delta]. \quad (2.31)$$

This theorem states that to prove the stability of a sampled-data dynamics, one must show that the inter-sample behavior is bounded (condition 2.31) and the discrete-time dynamics (considered as the sampled-data model behavior at sampling instants) is globally stable (condition 2.30). A local version can be stated.

In the following sections, it is assumed that the inter-sample behavior remains bounded under the assumption of a *forward complete* system³, and we focus the presentation on the stability of the discrete-time dynamics.

New definitions of stability can be employed, which takes into account the sampling parameter δ . The next definitions are taken from [Nešić et al. 1999]

³ A system is called *forward complete* if for every initial condition x_0 and every input signal u , the corresponding solution is defined for all $t > 0$.

Definition 26. Let $\beta \in \mathcal{KL}$ and let $N \subset \mathbb{R}^n$ be an open set containing the origin.

- The family (u_k, F^δ) is (β, N) stable, if there exists $\Delta > 0$ such that for each $\delta \in (0, \Delta)$ the solutions of (2.28) satisfy

$$|x(k, x(0))| \leq \beta(|x(0)|, k\delta), \forall x(0) \in N, k \geq 0. \quad (2.32)$$

- The family (u_k, F^δ) is (β, N) practically stable, if for each $R > 0$ there exists $\Delta > 0$ such that for each $\delta \in (0, \Delta)$ the solutions of (2.28) satisfy

$$|x(k, x(0))| \leq \beta(|x(0)|, k\delta) + R, \forall x(0) \in N, k \geq 0. \quad (2.33)$$

An equivalent Lyapunov formulation is also available from [Nešić *et al.* 1999].

Theorem 27. The following statements are equivalent:

- There exists $\beta \in \mathcal{KL}$ such that the family (u_k, F^δ) is (β, \mathbb{R}^n) stable.
- There exist $\Delta > 0$, $\rho_1, \rho_2 \in \mathcal{K}_\infty$ and for each $\delta \in (0, \Delta)$, $V^\delta : \mathbb{R}^n \rightarrow \mathbb{R}_+$, such that $\forall x \in \mathbb{R}^n, \forall \delta \in (0, \Delta)$ we have:

$$\rho_1(\|x_k\|) \leq V^\delta(x_k) \leq \rho_2(\|x_k\|) \quad (2.34)$$

$$V^\delta(x_{k+1}) - V^\delta(x_k) \leq -\delta\rho_3(\|x_k\|). \quad (2.35)$$

The proof of this theorem is given in [Nešić *et al.* 1999]. It is interesting to note, that the Lyapunov function that can be used to prove the stability properties is also depending on the sampling rate.

As it was mentioned before, the construction of global stabilizing digital controllers for sampled-data systems is rarely addressed, even impossible for nonlinear dynamics. In this context two approaches are usually proposed.

The first one, proposed in [Nešić *et al.* 1999] and developed in various context by many authors, starts with a computable approximation of (2.28) (usually Euler approximation), for which a digital global stabilizing controller can be designed. Under specific conditions of “consistency” between the approximated model and the exact sampled model, the controller is designed to stabilize globally and asymptotically the origin of the approximated model, then it stabilizes the sampled-data system but in a semiglobal practical sense.

The second approach, that is adopted in the thesis, proposes a digital controller that recovers the continuous-time stabilizing properties of a given continuous controller, at least at the sampling instants. As we will see next, this approach leads us to semiglobal results also and the origin is stable or asymptotically stable but does not refer to practical stability.

2.4.1 The case of the emulation of continuous-time state-feedback controllers

In this section we restrict the attention to the controller emulation, the mainly used method when a continuous-time controller issued from a nonlinear design is being digitally implemented.

Let us consider again the sampled-data system given by (2.27). Let us suppose that a continuous-time state-feedback controller $u_c(x(t))$ exists and brings the system to an asymptotically stable point. Then there exists a CLF V that satisfies properties 18 and 19. Then by using the converse Lyapunov theorem, one gets:

Proposition 28. *If there exists a state-feedback controller $u_c(x(t))$ such that the solution of the closed loop dynamics $\dot{x}(t) = \tilde{f}(x(t)) = f(x(t)) + u_c(x(t))g(x(t))$ is globally asymptotically stable, then there exist a CLF $V : \mathbb{R}^n \rightarrow \mathbb{R}$, $\rho_1, \rho_2, \rho_3 \in \mathcal{K}_\infty$ such that the following conditions hold:*

$$\rho_1(\|x\|) \leq V(x(t)) \leq \rho_2(\|x\|) \quad (2.36)$$

$$\dot{V}(x) < -\rho_3(\|x\|) \quad (2.37)$$

for every $x \in \mathbb{R}^n$.

The continuous-time evolution is used next as a reference for the digital design. In the literature, fewer works have addressed the problem of sampled-data stabilization by state-feedback controllers. A well documented study is offered in [Khalil 2004]. All the results state that if the continuous-time controller is stabilizing globally then the emulated controller stabilizes practically and globally in x . Only under the exponential stability condition of the equilibrium point, then one recovers $\lim_{t \rightarrow \infty} x(t) \rightarrow 0$ for the sampled-data systems.

Theorem 29. [Khalil 2004] *Consider the system $\dot{x} = f(x, u)$, where $f(0, 0) = 0$ and f is locally Lipschitz in its arguments in some domain that contains the origin. Let $u = \gamma(x)$ be a static state feedback control law with a locally Lipschitz function γ such that $\gamma(0)$ and the origin of the closed-loop system is asymptotically stable with the region of attraction N . Let N_0 be any compact set in the interior of N and $x_c(t)$ be a solution of the closed-loop system that starts in N_0 . Let $x(t)$ be the solution, with $x_c(0) = x(0)$, of the closed-loop sampled-data system that results from applying $u(t) = \gamma(x(k\delta))$, for $k\delta \leq t \leq (k+1)\delta$, and $x_{k+1} = F(x_k)$ be the exact discrete-time model at the sampling points. Then, the following hold.*

- There exists $\Delta_1 > 0$ such that, for every $0 < \delta \leq \Delta_1$, $x(t)$ is bounded for all $t \geq 0$, uniformly in δ .
- Given any $\mu > 0$, there exist $\Delta_2 > 0$ and $T_a > 0$, both dependent on μ and N_0 , such that, for every $0 < \delta \leq \Delta_2$, $x(t)$ satisfies $\|x(t)\| \leq \mu$, $\forall t \geq T_a$.
- Given any $\mu > 0$, there exists $\Delta_3 > 0$ dependent on μ and N_0 , such that, for every $0 < \delta \leq \Delta_3$, $x(t)$ satisfies $\|x(t) - x_c(t)\| \leq \mu$, $\forall t \geq 0$.

- If the origin of $\dot{x} = f(x, (\gamma\{x_j\}))$ is exponentially stable and f and γ are twice continuously differentiable in some neighborhood of the origin, then there exists $\Delta_4 > 0$ such that, for every $0 < \delta \leq \Delta_4$, the origin of $x_{k+1} = F(x_k)$ is exponentially stable and $x(t)$ decays to 0, exponentially fast, as $t \rightarrow 0$.

The first two bullets recall the *practical* stability of the solution. The size of the sampling periods are depending on the size of the set of initial conditions N_0 . It is shown for instance in [Clarke *et al.* 1997] that fast sampling is required in order to have a closer evolution to the equilibrium point (with small displacements) and also for large initial conditions when explosion times can occur. Hence, the choice of the sampling period has to take into account the accuracy desired for controlling the system to 0 and also the size of the initial condition set.

The condition stated in the third bullet states that the trajectory of the sampled evolution can be chosen close to the continuous ones with a bound that depends also on the sampling period. The last property gives the condition when $x(t)$ goes to zero.

STABILITY ANALYSIS In the next lines, the objective is to track the mismatches between the Lyapunov evolution of the continuous-time system and the sampled-data one. The Lyapunov characterization of an emulated state-feedback controller via energy like functions is also derived.

Let us consider the closed loop dynamics, issued from a global stabilizing state-feedback controller $u_c(x(t))$:

$$\dot{x}_c(t) = \tilde{f}(x_c(t)) \quad (2.38)$$

which globally asymptotically stabilizes the origin. Its discrete-time equivalent can be described by the difference equation:

$$x_{k+1}^c = e^{\delta L_{\tilde{f}}} x_k^c \quad (2.39)$$

under the condition that $0 < \delta < \Delta$, where $\Delta > 0$ is the maximum sampling period that assures the convergence of the right hand term in (2.39). The discrete-time equivalent preserves the same Lyapunov stability properties as the continuous-time system at the sampling instants⁴.

with Lyapunov evolution computed as follows:

$$V(x_{k+1}^c) = V(x_k^c) + \delta L_{\tilde{f}} V(x_k^c) + \frac{\delta^2}{2!} L_{\tilde{f}}^2 V(x_k^c) + O_1(\delta^3) \quad (2.40)$$

Now, let us consider the discrete-time equivalent of the sampled-data system, when the control is kept constant over sampling periods so that $u_k = u_c(x(k\delta))$, for all $t \in [k\delta, (k+1)\delta)$:

$$x_{k+1} = e^{\delta(L_f + u_k L_g)} x_k \quad (2.41)$$

⁴ In the following lines we make the following notation: x_k^c stands for the discrete-time evolution at the sampling instants of the state issued from a continuous-time dynamics $x_c(t)$ at time $t = k\delta$ and x_k stands for the sampled-data dynamics.

In this case the Lyapunov evolution can be computed from the state evolution as follows:

$$V(x_{k+1}) = V(x_k) + \delta L_{f+u_k g} V(x_k) + \frac{\delta^2}{2!} L_{f+u_k g}^2 V(x_k) + O_1(\delta^3) \quad (2.42)$$

The Lyapunov dynamics (2.40) and (2.42) are different even when starting from the same initial conditions, and to evaluate this we define the Lyapunov Matching Error (LME) $E_V(x_k)$ as the mismatch one step ahead between the desired value of $V(x(t))$ at instant $|_{(k+1)\delta}$ (2.40) and the attained value of V under constant control (2.42), one gets:

$$E_V(x_k) = V(x_{k+1}) - V(x_{k+1}^c) \quad (2.43)$$

under the assumption of the same initial condition $x_k^c = x_k$. By computing further on, the difference (2.43), by employing series expansions, one gets for the first terms

$$\begin{aligned} E_V(x_k) &= \delta(u_k L_g V(x_k) - u_c(x_k) L_g V(x_k)) + \frac{\delta^2}{2!} ((L_f + u_k L_g)^2 V(x_k) \\ &\quad - (L_f + u_c L_g)^2 V(x_k) + \dot{u}_c L_g V(x_k)) + O(\delta^3) \\ &= -\frac{\delta^2}{2!} \dot{u}_c L_g V(x_k) + O(\delta^3). \end{aligned} \quad (2.44)$$

Now the Lyapunov difference of the sampled evolution can be written as

$$V(x_{k+1}) - V(x_k) = V(x_{k+1}^c) - V(x_k^c) + E_V(x_k) \quad (2.45)$$

Now let us formulate next the Lyapunov function characterization in the case of a P approximated controller.

Proposition 30. *Given the dynamics (2.14), suppose there exists u_c with CLF V ensuring GAS of the equilibrium. Then there exist $\Delta > 0$ and $\rho_1, \rho_2, \rho_4 \mathcal{K}_\infty$ functions, such that for any $\delta \in (0, \Delta)$ then the Lyapunov evolution of the dynamics (2.14) with emulated controller $u_{d0} = u_c(x(t))|_{t=k\delta}$ satisfies*

$$\rho_1(\|x_k\|) + O(\delta^1) \leq V(x_k) \leq \rho_2(\|x_k\|) + O(\delta^1) \quad (2.46)$$

$$V(x_{k+1}) - V(x_k) \leq -\delta \rho_4(\|x_k\|) + O(\delta^2). \quad (2.47)$$

Proof. The existence of a CLF - V function for the continuous-time system, the converse Lyapunov theorem allows to describe the Lyapunov evolutions as follows:

$$\rho_1(\|x(t)\|) \leq V(x(t)) \leq \rho_2(\|x(t)\|) \quad (2.48)$$

$$\dot{V}(x(t)) \leq -\rho_3(\|x(t)\|) \quad (2.49)$$

with ρ_1, ρ_2 and ρ_3 as K_∞ functions. The discrete-time equivalent of system (2.14) is (2.28), computed as

$$x_c((k+1)\delta) = e^{\delta L_{\tilde{f}} x_c(k\delta)}$$

with Lie operators. It follows the next successions:

$$V(x_{k+1}^c) - V(x_k^c) = \int_{k\delta}^{(k+1)\delta} \dot{V}(x_c(t)) dt \quad (2.50)$$

By the use of Mean Value Theorem, then there exists t_m such that for $k\delta < t_m < (k+1)\delta$ and taking into account inequality (2.9) then

$$\int_{k\delta}^{(k+1)\delta} \dot{V}_c(x(t)) dt \leq -\delta \rho_3(\|x_c(t_m)\|) \quad (2.51)$$

Equality (2.40) can be rewritten as follows:

$$\begin{aligned} V(x_{k+1}^c) - V(x_k^c) &= -\delta \left(-L_{\tilde{f}} V(x_c(k\delta)) - \frac{\delta^1}{2!} L_{\tilde{f}}^2 V(x_c(k\delta)) - O_1(\delta^2) \right) \\ &= -\delta W_a(x_c(k\delta)) \end{aligned} \quad (2.52)$$

As $W_a(x_c(t))$ is a positive definite function the applying [Khalil 1996, Lemma 4.3] then there exists ρ_4, ρ_5 \mathcal{K} functions such that:

$$\rho_4(\|x_c(k\delta)\|) \leq W_a(x_c(k\delta)) \leq \rho_5(\|x_c(k\delta)\|) \quad (2.53)$$

Then applying this result with equality (2.52) one gets that the next identity

$$V(x_c((k+1)\delta), u_c) - V(x_c(k\delta)) \leq -\delta \rho_4(\|x_c(k\delta)\|) \quad (2.54)$$

Now making reference to the LME definition the sampled-data Lyapunov difference can be rewritten as in (2.45). Taking into account the inequality (2.54) then

$$V(x_{k+1}) - V(x_k) \leq -\delta \rho_4(\|x_k\|) + E_V(x_k) \quad (2.55)$$

If we consider now the emulated state-feedback controller u_{d0} and the equality (2.44), rewriting the terms one gets:

$$V(x_{k+1}) - V(x_k) \leq -\delta \rho_4(\|x_k\|) + O(\delta^2) \quad (2.56)$$

□

In the above inequalities (2.46)-(2.47), it can not be guaranteed that the Lyapunov difference remains negative for all $\delta < \Delta$ and all $x_k \in \mathbb{R}^n$. This means that the stabilization properties of the sampled-data scheme can be ensured under the condition that $O(\delta^2)$ term does not influence the negativity of the right hand term of the inequality. It follows that restrictions on the sampling period and on

the initial set are necessary to impose to guarantee specific stability performance. This is a difficult task since these settings can not be precisely found due to the nonlinearities. For some δ and initial conditions it is possible for the sampled Lyapunov difference to be equal to zero. In this case we can speak about practical stabilization, because the trajectories are no more converging to the equilibrium but remain bounded.

2.5 EXAMPLE 2.

Let us consider the next second order dynamics:

$$\begin{aligned}\dot{x}_1(t) &= -x_1(t)^3 + x_1(t)u(t) \\ \dot{x}_2(t) &= u(t).\end{aligned}\tag{2.57}$$

For these dynamics a Lyapunov function candidate is $V = x_2^2(t)/2$ and a $L_g V$ controller that stabilizes asymptotically the origin $x_e = (0,0)^T$ of (2.57) is:

$$u_c(t) = -KL_g V = -Kx_2, K > 0\tag{2.58}$$

This controller, according to Theorem 21, provides asymptotic stabilization of the equilibrium i.e.

$$\dot{V} = x_2 u = -Kx_2^2 < 0, \forall x_2 \in \mathbb{R}.$$

This example is interesting since the dynamics satisfy the passivity condition $\dot{V} \leq uy$ if the output is chosen as $y(t) = L_g V(x(t))$. Also for $K = \frac{1}{2}$ the controller is said to be optimal for the cost criteria $J = \int_0^\infty x_2^2(t) + u(t)^2 dt$.

Let us set for the continuous and sampled-data dynamics, the same initial condition $x_k = x_c(k\delta)$. Then, the closed-loop continuous-time Lyapunov evolution computed at instant $(k+1)\delta$ is

$$V(x_{k+1}^c) = \frac{1}{2}(x_{2k}^c)^2 e^{-2K\delta} = \frac{1}{2}(x_{2k}^c)^2 (1 - 2K\delta + 2K^2\delta^2 + O(\delta^3))\tag{2.59}$$

and the sampled-data evolution (when u_k is constant along intervals of length δ) is exactly computed as:

$$V(x_{k+1}) = \frac{1}{2}(x_{2k}^2 + 2\delta x_{2k} u_k + \delta^2 u_k^2) = \frac{1}{2}(x_{2k} + \delta u_k)^2 \geq 0\tag{2.60}$$

The sampled-data Lyapunov evolution is computed exactly, and this fact is useful in the next developments.

From the above definitions $V(x_{k+1}^c) > 0$ and $V(x_{k+1}^c) - V(x_k^c) = \frac{1}{2}(x_{2k}^c)^2 (e^{-2K\delta} - 1) < 0$ for any $K\delta > 0$.

By considering the emulated controller $u_k = -Kx_{2k}$, then the Lyapunov difference satisfies:

$$V(x_{k+1}) - V(x_k) = \frac{1}{2}K\delta x_{2k}^2(-2 + K\delta) < 0, \text{ for } \delta < \frac{2}{K}. \quad (2.61)$$

It is thus verified that the use of an emulated controller reduces significantly the admissible pair (K, δ) to an upper bound of 2 on the product $K\delta$. For an optimal controller: e.g. $K = 1/2$, this means a maximum sampling rate equal to 4.

This simple calculus shows that the stability properties of the emulated controller are no more assured globally. Also the choice of an admissible sampling period also depends on the gain of the controller. For larger K the values of δ are smaller. For smaller K , larger sampling periods are possible but the drawback is the speed of convergence that is notably reduced. Let us denote by δ_e the maximum sampling period of the emulated control for a fixed K , such that $\delta_e = 2/K$. Then, for any $\delta \in (0, \delta_e)$ the emulated controller stabilizes asymptotically the sampled-data system for any $x(0)$ from the initial set. In this case, global results with respect with x can be addressed.

This chapter deals with the concept of *input-Lyapunov matching* for sampled-data nonlinear systems. This approach is developed for an input-affine system [Tiefensee 2010], [Monaco & Normand-Cyrot 2001], [Monaco & Normand-Cyrot 2009] and represents the basic methodological tool used in this work. The stabilizing performances of the sampled-data controllers designed in this framework, are analyzed. A motivating example is also given to highlight the properties. Some extensions are given for systems with higher relative degrees with respect to Lyapunov function and to MIMO systems.

3.1 THE CONCEPT OF INPUT-LYAPUNOV MATCHING

The concept of input-Lyapunov matching under digital feedback is derived from a more general one - the input/output matching. The basic idea is as follows:

Given a continuous-time dynamics described by ordinary differential equations and smooth vector fields functions, given also a continuous-time controller designed to satisfy control objectives on a certain output mapping, one assumes that the control is kept constant over time intervals of constant length and look for a digital controller, such that its performance on the system output be the same as those of the ideal continuous-time strategy. This coincidence is requested at the sampling instants only ($t = k\delta$). Such a problem is referred to as the *input-output matching under digital control*. In the current work, the same definition is applied to the input/Lyapunov function link.

In the previous sections there were pointed out the limits of the emulated controllers. For improving the performances of our controllers we are interested in extending the stabilizing performances of the emulated controllers. The key point is represented by the inequality (2.47) with the aim to reduce the influence of the terms included in $O(\delta^2)$. The strategy proposed here *input/Lyapunov matching* supposes the design of a particular expansion of the digital controller u_k so that it cancels the terms in $O(\delta^2)$. This strategy it was introduced in the context of feedback linearization [Monaco *et al.* 1986]

and further developed in [Tiefensee *et al.* 2009] to the stabilization of a SMIB (single-machine infinity bus system) and in [Tiefensee *et al.* 2010b] to the IDA-PBC (Interconnection and Damping Assignment - Passivity Based Controller) context.

INPUT/LYAPUNOV MATCHING - DEFINITION Let us assume $u_c(t) = u_k$ over each interval of length δ , then the sampled-data equivalent of equation (2.14) is described by

$$x_{k+1} = F_d^\delta(x_k, u_k) = e^{\delta(f_c + u_k g_c)} x_k \quad (3.1)$$

Given a control law u_c with a Lyapunov function $V(x)$ which satisfies the conditions from Proposition 15, one computes through integration:

$$V(x_c(t = (k+1)\delta)) - V(x_c(t = k\delta)) = \int_{k\delta}^{(k+1)\delta} \dot{V}(x_c(\tau)) d\tau, \quad (3.2)$$

where x_c indicates the closed loop continuous-time x -dynamics under u_c .

The equality (3.2) indicates the continuous-time target difference.

Definition 31. *Input/Lyapunov matching property is satisfied if there exists a piecewise constant control law u_k such that the Lyapunov evolution of the sampled-data dynamics match (3.2) at the sampling instants $t = k\delta$. That is, u_k must satisfy the equality:*

$$V(x_{k+1}) - V(x_k) = \int_{k\delta}^{(k+1)\delta} \dot{V}(x_c(\tau)) d\tau. \quad (3.3)$$

where $x_k = x_c(t = k\delta)$ and x_{k+1} is computed from (3.1).

Hence the digital control u_k reproduces, at sampling instants, the Lyapunov performance of the continuous-time closed loop system and achieves asymptotic stabilization of the sampled system for small enough sampling periods¹.

The next existence Theorem is also given in [Tiefensee 2010] and represents the main result from which many new designs were developed.

Theorem 32. *Let us consider the system of the form (2.14), and suppose the existence of a continuous-time feedback control law u_c , such that a Lyapunov function V exists, which guarantees the stability of the initial system. Then there exists $T^* > 0$ such that for any δ in $(0, T^*]$ there exists a digital feedback $u_k = u_d^\delta$ which ensures the same Lyapunov evolution under sampling² and guarantees the asymptotic stability of the sampled-data equivalent system.*

¹ The sampling period is chosen small enough to guarantee the convergence of the exponential form (3.1)

² The same Lyapunov evolutions under sampling can be understood also as the reproduction under digital control of the stability performances of the continuous-time dynamics at least at each sampling instant

Proof. The proof is worked out by showing that there exists a solution in the form of an asymptotic expansion in powers of δ

$$\mathbf{u}_k = \mathbf{u}_d^\delta = \mathbf{u}_{d0} + \sum_{i \geq 1} \frac{\delta^i}{(i+1)!} \mathbf{u}_{di}. \quad (3.4)$$

for the equation (3.3).

By considering the Lie series commutation Theorem, one can rewrite [Grobner & Knapp 1967]

$$\mathcal{V}(e^{\delta(f+\mathbf{u}_k g)} \chi \Big|_{x_k}) = e^{\delta(f+\mathbf{u}_k g)} \mathcal{V}(\chi) \Big|_{x_k},$$

for a fixed couple (x_k, \mathbf{u}_k) . It follows that (3.3) can be rewritten as the formal series equality :

$$\delta Q(x_k, \delta, \mathbf{u}_k) = e^{\delta(f(\cdot)+\mathbf{u}_k g(\cdot))} \mathcal{V}|_{x_k} - e^{\delta(f(\cdot)+\mathbf{u}_c(\cdot)g(\cdot))} \mathcal{V}|_{x_k} = 0. \quad (3.5)$$

with a suitable defined series $Q(x, \delta, \mathbf{u})$. By expanding the last equality up to a 3-th order one gets

$$\begin{aligned} Q(x_k, \delta, \mathbf{u}_k) &= (L_f + \mathbf{u}_k L_g) \mathcal{V}|_{x_k} + \frac{\delta}{2!} (L_f^2 + \mathbf{u}_k (L_g L_f + L_f L_g) + \mathbf{u}_k^2 L_g^2) \mathcal{V}|_{x_k} + \frac{\delta^2}{3!} (L_f + \mathbf{u}_k L_g)^3 \mathcal{V}|_{x_k} + O_1(\delta^3) \\ &- (L_f + \mathbf{u}_c L_g) \mathcal{V}|_{x_k} + \frac{\delta}{2!} (L_f^2 + \mathbf{u}_c (L_g L_f + L_f L_g) + \mathbf{u}_c^2 L_g^2 + \dot{\mathbf{u}}_c L_g) \mathcal{V}|_{x_k} \\ &- \frac{\delta^2}{3!} \left((L_f + \mathbf{u}_c L_g)^3 + 2\dot{\mathbf{u}}_c (L_f + \mathbf{u}_c L_g) L_g + \dot{\mathbf{u}}_c L_g (L_f + \mathbf{u}_c L_g) + \ddot{\mathbf{u}}_c L_g \right) \mathcal{V}|_{x_k} - O_2(\delta^3) \end{aligned} \quad (3.6)$$

with $O_1(\delta^3)$ the remaining terms of the sampled data Lyapunov expansion and $O_2(\delta^3)$ the remaining terms of the continuous Lyapunov expansion.

Given x_k and δ , the problem is to find \mathbf{u}_k such that (3.5) holds. To do so, one first verifies that for $\delta = 0$:

$$Q(x_k, 0, \mathbf{u}_{d0}) = (L_f + \mathbf{u}_{d0} L_g) \mathcal{V}|_{x_k} - (L_f + \mathbf{u}_c(\cdot) L_g) \mathcal{V}|_{x_k} = 0$$

for $\mathbf{u}_{d0}(k) = \mathbf{u}_c(x)|_{x_k}$. Since $L_g \mathcal{V}|_{x_k} \neq 0$ for all x_k , one verifies the non singularity condition

$$\left. \frac{\partial Q(x_k, \delta, \mathbf{u}_k)}{\partial \mathbf{u}_k} \right|_{\delta=0, \mathbf{u}_k=\mathbf{u}_{d0}} = L_g \mathcal{V}|_{x_k} \neq 0.$$

By the *implicit function Theorem* [Lee 2006, Th.7.9] it follows that a solution $\mathbf{u}_k = \mathbf{u}_d^\delta = \gamma(x_k, \delta)$ to (3.5) exists in a neighborhood of \mathbf{u}_{d0} , for a δ small enough. It satisfies the condition

$$Q(x_k, \delta, \gamma(x_k, \delta)) = 0$$

with

$$\mathbf{u}_{d0} = \mathbf{u}_k = \gamma(x_k, 0).$$

The Lyapunov stability of the sampled-data system is proven by showing that, since $(L_f + \mathbf{u}_c L_g) \mathcal{V}(x) < 0$ and \mathbf{u}_d^δ satisfies (3.3), one verifies at the sampling instants

$$\mathcal{V}(x_{k+1}) - \mathcal{V}(x_k) = \int_{k\delta}^{(k+1)\delta} (L_{f(\cdot)} + \mathbf{u}_c(\cdot) L_{g(\cdot)}) \mathcal{V}(x(\tau)) d\tau < 0 \quad (3.7)$$

□

Remark 33. *Theorem 32 holds globally (in x) or locally depending on the assumptions taken for the design of the continuous-time controller.*

Important Remark. The theorem states that a digital controller which ensures the Lyapunov reproduction under sampling exists, and the proof is constructive through successive higher order approximations.

The terms of u_d^δ are computed from (3.5) with the unknown variable u_k . The equality is solved, after replacing u_k with (3.4), and then by comparing and equating the terms in δ . The first computed terms of u_d^δ , also given in [Tiefensee 2010], are:

$$u_{d0}(x_k) = u_c|_{x_k} \quad (3.8)$$

$$u_{d1}(x_k) = \dot{u}_c|_{x_k} \quad (3.9)$$

$$u_{d2}(x_k) = \ddot{u}_c + \frac{u_{d1}}{2} \text{ad}_{[f_c, g_c]} V(L_g V)^{-1}|_{x_k}. \quad (3.10)$$

$$\begin{aligned} u_{d3}(x_k) &= \ddot{u}_c + \frac{\dot{u}_c}{L_g V} \text{ad}_{[f, g]} V|_{x_k} \\ &+ \frac{\dot{u}_c}{L_g V} (-\text{ad}_f^2 g + u_c \text{ad}_f g L_g + 2L_f^2 L_g - 3L_f L_g L_f) V|_{x_k} \\ &- \frac{\dot{u}_c}{L_g V} \left((L_f L_g + L_g L_f + 2u_c L_g^2) V \text{ad}_f g \right) V|_{x_k}. \end{aligned} \quad (3.11)$$

These expressions are well defined since by definition of strict-feedback systems $L_g V(x) \neq 0$, for all $x \neq 0$. Recursive algorithms and other details can be found in [Monaco & Normand-Cyrot 2007, Monaco & Normand-Cyrot 2009].

3.2 CONTROLLER APPROXIMATION

The digital controller u_d^δ provided by Theorem 32 reproduces the continuous-time Lyapunov closed-loop evolution under sampling, hence the sampled-data solution is also asymptotically stable, for a small enough δ . However, through practical implementations, the exact controller is not computable and approximate solutions are used from the series expansion of u_d^δ .

Definition 34. *The approximate digital controller of order P means $u_d^{\delta P} = u_{d0} + \frac{\delta}{2} u_{d1} + \dots + \frac{\delta^P}{(P+1)!} u_{dP}$ which ensures the equality (3.3) up to δ^P (error in δ^{P+1})*

Based on the discussions made in Section 2.4.1 the following property holds.

Proposition 35. *Given the same conditions as in Proposition 30, then the Lyapunov difference of the sampled-data system with a P order approximated digital controller satisfies :*

$$\rho_1(\|x_k\|) + O(\delta^{P+1}) \leq V(x_k) \leq \rho_2(\|x_k\|) + O(\delta^{P+1}) \quad (3.12)$$

$$V(x_{k+1}) - V(x_k) \leq -\delta\rho_4(\|x_k\|) + O(\delta^{P+2}). \quad (3.13)$$

with $O(\delta^{P+1})$ the higher order terms in δ which depends on the state variables.

Proof. The proof is immediate by following the proof of Proposition 30. The main difference is that the LME has the first P terms zero, e.g.:

$$E_V(x_k) = \frac{\delta^{P+1}}{(P+1)!} \left(L_{\tilde{f}}^{P+1} V(x_k) - L_{\tilde{f}}^{P+1} V(x_c|_{t=k\delta}) \right) + O(\delta^{P+2})|_{t=k\delta} \quad (3.14)$$

□

This property means that the approximated P order controller guarantees the stability of the closed-loop sampled equivalent system for a small enough sampling period, which depends on the P order and on the nonlinearities of the dynamics. Compared to the emulated solution, this inequality is not depending on the lower powers of δ terms and therefore larger sampling periods are possible.

It must be stressed out that when one considers a specific digital controller approximation this does not mean that the stability performances cannot be guaranteed to holds in a practical way. For each approximate controller, the Lyapunov stability is ensured with a proper choice of the initial set conditions and of the sampling period. In this situation asymptotic stabilization is achieved (not in the practical sense) for any sampling period sufficiently small. For larger sampling periods, the terms in $O(\delta^P)$ can influence the negativity of the Lyapunov difference so the conditions from Theorem 27 are no longer satisfied. In such situations instability or, when the Lyapunov difference is zero, practical stabilization can be met. But these situations are excluded in this work by restricting δ to be so small such that the terms in $O(\delta^P)$ do not influence the negativity of the term $\delta\rho_3(\|x_k\|)$.

Increasing the order of the controller approximation we can expect at larger sampling periods and hence at larger sets of initial conditions.

Concluding Remark. Considering a P-order controller $u_d^{\delta P}$ the Lyapunov difference can be expressed as (3.13) , i.e.

$$V(x_{k+1}) - V(x_k) \leq -\delta\rho_4(\|x_k\|) + O(\delta^{P+2})$$

Compared to the emulated version (2.47), this solution adds specific terms to the emulated control and the domain of attraction of the equilibrium point is consequently enlarged; as a

consequence larger sampling periods can be considered and a more accurate convergence is observed. Global results (in terms of state variables) can be obtained if the controller u_d^δ can be computed exactly through the resolution of algebraic equalities of finite order rather than series inversion.

3.3 EXAMPLE 2- CORRECTIVE TERMS

Let us continue the analysis of the example given in section 2.5. We noted that when using an emulated controller for any $\delta \in (0, \delta_e)$ with $\delta_e = 2/K$ the sampled-data system was stable. Let us now consider the same analysis when a digital controller with one or more additional terms is implemented; so reducing the Lyapunov matching error for larger δ_e as characterized in Section 2.5.

3.3.1 First order controller

If we denote by $u_d^{\delta 1} = u_{d0} + \frac{\delta}{2}u_{d1}$ the first order controller, then by using relations (3.8)-(3.9) one gets

$$u_d^{\delta 1} = -Kx_{2k}(1 - \frac{\delta}{2}K) \quad (3.15)$$

The sampled-data Lyapunov evolution is described by the next expression

$$\begin{aligned} V(x_{k+1}) &= \frac{1}{2}x_{2k}^2 + \delta x_{2k}(u_{d0} + \frac{\delta}{2}u_{d1}) + \frac{\delta^2}{2!}(u_{d0} + \frac{\delta}{2}u_{d1})^2 \\ &= \frac{x_{2k}^2}{8} \left(1 + (\delta K - 1)^2\right) \geq 0, \quad \forall K, x_{2k} \end{aligned} \quad (3.16)$$

The Lyapunov difference is

$$V(x_{k+1}) - V(x_k) = x_{2k}^2 K \delta \left(-1 + \delta K - \frac{\delta^2 K^2}{2} + \frac{\delta^3 K^3}{8} \right) \quad (3.17)$$

This difference is negative definite only for $x_{2k} \neq 0$ and $\delta \leq \frac{2}{K}$, which represents the same condition obtained as for the emulated controller.

Let us now compare the Lyapunov mismatches between the continuous-time and sampled data evolution,

$$E_V(x_k) = V(x_{k+1}) - V(x_k^c) = x_{2k}^2 \left(-\frac{\delta^3 K^3}{6} + O(\delta^4) \right) \quad (3.18)$$

From the last identity one gets that

$$\begin{aligned} V(x_{k+1}) - V(x_k) &= V(x_{k+1}^c) - V(x_k^c) + E_V(x_k) \\ &\leq -\delta \rho_3(\|x_{2k}\|) + O(\delta^3) \end{aligned} \quad (3.19)$$

Compared to the emulated controller, the inequality (3.19) shows that a better matching is achieved and thus better stability performance is expected. Although the error in δ is smaller, this does not always mean that a larger sampling period can be allowed. In this case the maximum sampling period remains the same as in the emulated case ($\delta_e < \frac{2}{K}$).

3.3.2 Second order controller

Let us now use a second order controller $u_d^{\delta 2} = u_{d0} + \frac{\delta}{2}u_{d1} + \frac{\delta^2}{6}u_{d2}$ computed by using relations (3.8)-(3.10) one gets

$$u_{da2}^{\delta 2} = -Kx_{2k}\left(1 - \frac{\delta}{2}K + \frac{\delta^2}{3!}K^2\right) \quad (3.20)$$

The sampled-data Lyapunov evolution is described by the next expression

$$V(x_{k+1}) = \frac{x_{2k}^2}{72} \left(-5 + K\delta + (K\delta - 1)^3\right)^2 \geq 0, \quad \forall K, x_{2k} \quad (3.21)$$

The Lyapunov difference is

$$V(x_{k+1}) - V(x_k) = x_{2k}^2 K \delta \left(-1 + K\delta - \frac{2K^2\delta^2}{3} + \frac{7\delta^3 K^3}{24} - \frac{\delta^4 K^4}{12} + \frac{\delta^5 K^5}{72}\right) \quad (3.22)$$

This difference is negative definite only for $x_{2k} \neq 0$ and $\delta \leq \frac{2.5}{K}$. This new bound for δ is larger than the one obtained from the previous cases.

Let us now compare the Lyapunov mismatches between the continuous-time and sampled data evolutions,

$$E_V(x_k) = V(x_{k+1}) - V(x_{k+1}^c) = x_{2k}^2 \left(-\frac{\delta^4 K^4}{24} + O(\delta^5)\right) \quad (3.23)$$

From the last identity one gets that

$$\begin{aligned} V(x_{k+1}) - V(x_k) &= V(x_{k+1}^c) - V(x_k^c) + E_V(x_k) \\ &\leq -\delta \rho_4(\|x_{2k}\|) + O(\delta^4) \end{aligned} \quad (3.24)$$

Compared to the emulated controller, the inequality (3.24) shows that a better matching is achieved and hence better stability properties are expected. In this case, the second order controller also extends the use of the sampling period beyond the bound found for the emulated and first order controller ones.

The design of higher order controllers can be continued and better stability results can be obtained. It has to be note that the complexity of the controller expression increases with the order of approximation and this fact can give numerical errors due to truncation and integrations that appear during the simulation time.

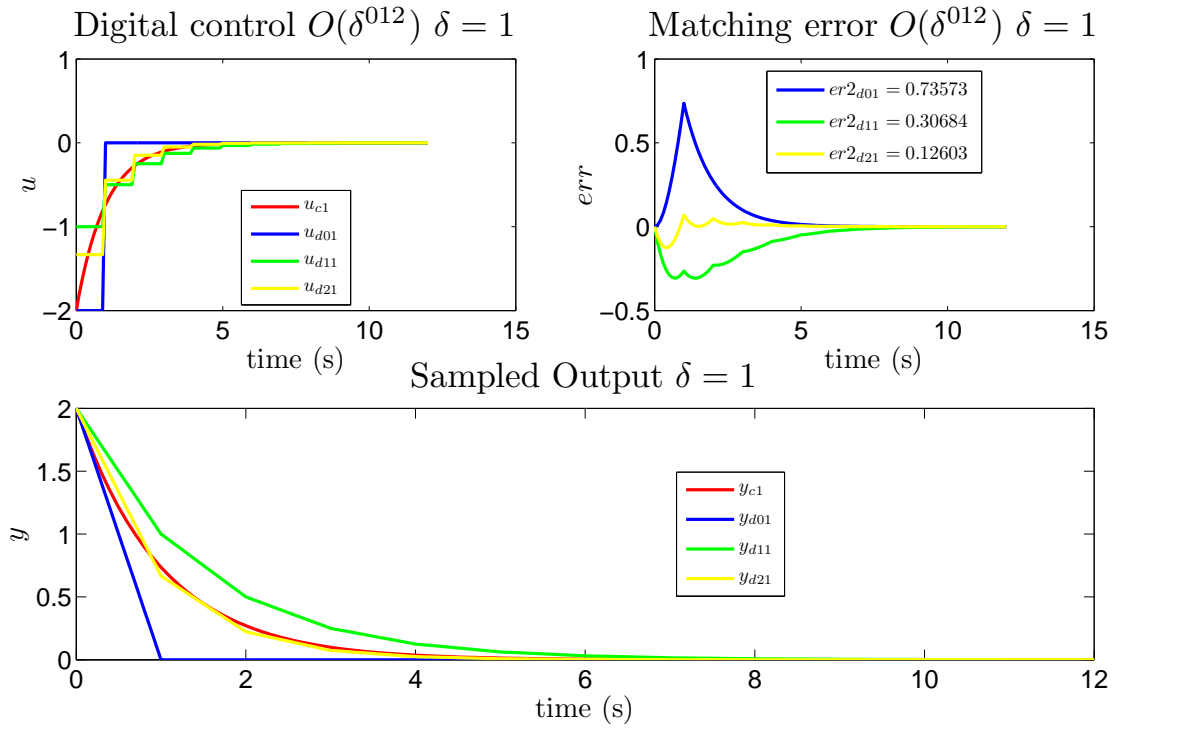

(a) Systems evolutions for $\delta = 1$ s

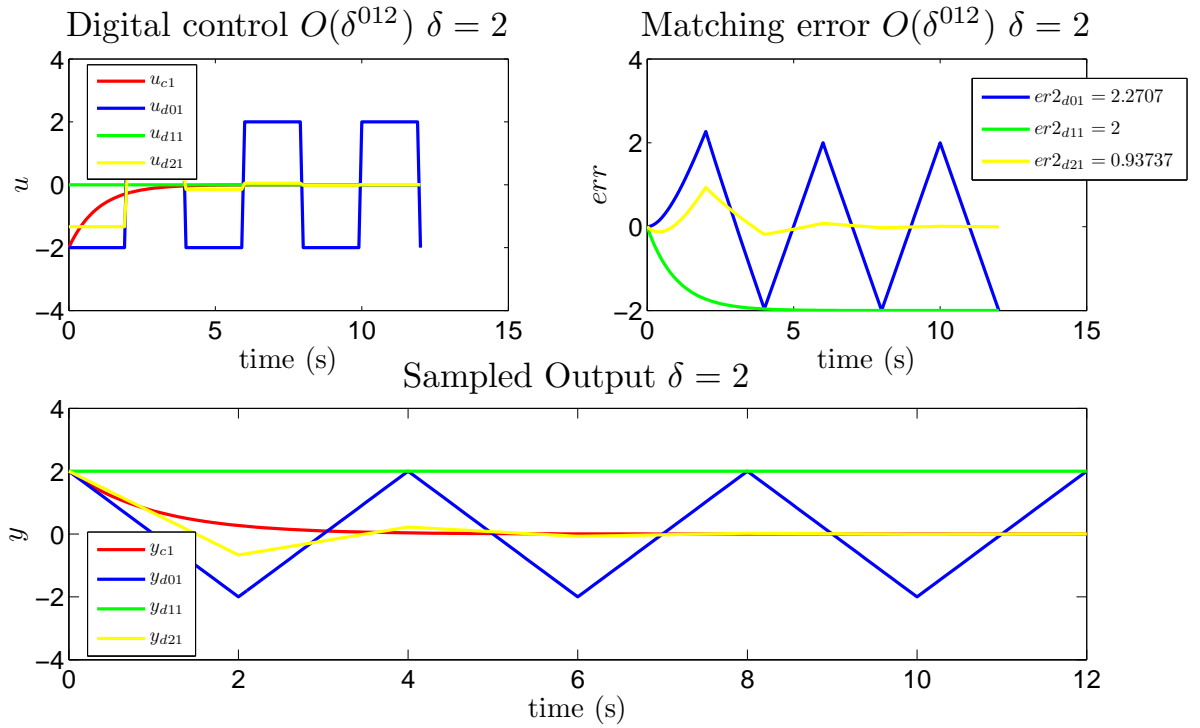

(b) Systems evolutions for $\delta = 2$ s

Figure 3.1: Systems evolutions for different controller approximations

sampling period	initial condition	gain	simulation time length	figure label
$\delta = 1$ s	$x_0 = [2 \ 2]$	$K = 1$	$t_f = 12$ s	Figure 3.1a)
$\delta = 2$ s	$x_0 = [2 \ 2]$	$K = 1$	$t_f = 12$ s	Figure 3.1b)

Table 3.1: Numerical values of the simulation parameters- Example 2

In the Figure 1.2 is depicted the controller and the output (considered here the same with x_2 state) evolutions for sampling periods equal to 1, respectively 2 seconds. The simulations parameters used for the plotted results are given in Table 3.1. The controller tested are the continuous-time controller (red color), the emulated controller (blue), the first and second order controller (green and yellow respectively). The matching error plots evaluates in fact the E_V evolution, and the error criteria is defined in Section 5.2.4. As the computations have shown, for $\delta = 2$ the emulated and the first order controller are at the limit of stability. The emulated controller is oscillating, and the first order controller brings the system to a stable evolution but far from the origin. For a lower sampling period we can observe that the matching error is decreasing as the order of the controller increases.

It has to be pointed out, that in this particular example, other solutions are possible. A computation of an exact digital controller that satisfies the negativity of (2.61) can be performed. Accordingly, one gets

$$V(x_{k+1}) - V(x_k) = \frac{1}{2} (x_{2k} + \delta u_k)^2 - \frac{1}{2} x_{2k}^2 < 0. \quad (3.25)$$

The solution to the last identity offers many variants to provide an exact controller that has to satisfy $-2x_{2k} \leq \delta u < 0$. One of this solution could be $\delta u = -\frac{x_{2k}}{K+1/2}$.

Concluding Remark. For the considered example, the first corrective term improves the stabilizing properties but has no effect to increase the size of the initial conditions set. On the other hand, the second corrective term improves both the stability performance and the size of the admissible sampling period.

3.4 RELATIVE DEGREE HIGHER THAN 1

In this section we make the following abuse of language. The relative degree definition is given in [Section 1.3.5](#). This notion is here applied in the context of the input/Lyapunov evolution by replacing the output function by a Lyapunov function. In this sense we use the term of relative degree with respect to V .

In [Section 3.2](#) the digital proposed controller solution is well defined if the continuous-time system has a degree relative 1 (with respect to V), which means that $L_g V \neq 0$. We now consider the case for which this condition is no more satisfied. In order to simplify the presentation, let us consider the case of relative degree 2 with respect to V , that is $L_g V = 0$ and $L_g L_f V \neq 0$.

By applying the same procedure as in the case of relative degree 1, the series equality (3.6), which solves the problem of the input/Lyapunov matching, can be particularized into this context, by setting that all the terms that are derived from $L_g V$ which all are equal to 0, one gets: follows:

$$\begin{aligned} \delta^2 Q'(x_k, \delta, u_k) &= \frac{1}{2!} (L_f^2 + u_k L_g L_f) V|_{x_k} + \frac{\delta}{3!} (L_f^3 + u_k^2 L_g^2 L_f + u_k (L_f L_g L_f + L_g L_f^2)) V|_{x_k} + O_1(\delta^2) \\ &- \frac{1}{2!} (L_f^2 + u_c L_g L_f) V|_{x_k} - \frac{\delta^1}{3!} (L_f^3 + u_c^2 L_g^2 L_f + u_c (L_g L_f^2 + L_f L_g L_f) + u_c L_g L_f) V|_{x_k} \\ &- O_2(\delta^2) \end{aligned} \quad (3.26)$$

One verifies for $\delta = 0$:

$$Q'(x_k, 0, u_{d0}) = (L_f^2 + u_{d0} L_g L_f) V|_{x_k} - (L_f^2 + u_c(\cdot) L_g L_f) V|_{x_k} = 0$$

so setting $u_{d0}(k) = u_c(x)|_{x_k}$. By replacing the controller expansion (3.4) into equality (3.26), and equating the δ coefficients to 0, the first controller terms are obtained as follows:

$$\begin{aligned} u_{d0} &= u_c(x_k); \\ u_{d1} &= \frac{2}{3} \dot{u}_c(x_k); \\ u_{d2} &= \left(\frac{1}{2} \ddot{u}_c - \frac{1}{4} u_{d1} (L_f L_g L_f + L_g L_f^2 - u_{d0} L_g^2 L_f) V / L_g L_f V \right) |_{x_k}; \end{aligned} \quad (3.27)$$

Compared to the case of the relative degree 1, this solution gives more complex expressions and is depending on higher derivatives of the system dynamics. The next property holds:

Proposition 36. *By assuming the same conditions as in Proposition 35 with relative degree 2 with respect to V , the approximated controller of order P , $u_{d12}^{\delta P}$, asymptotically stabilizes the nonlinear system with relative degree 2 with an error on V matching $O(\delta^{P+2})$.*

Proof. By assuming the same conditions, after some computations, the approximated controller of P order gives the following

$$V(x_{k+1}) - V(x_k) = -\delta(\rho_V(\|x_k\|)) + O_V(\delta^{P+2}) \quad (3.28)$$

where ρ_V is a \mathcal{K} function defined for the continuous-time controller case. \square

Concluding Remark. For any relative degree r of a system with respect to V , a digital controller can be computed. It can be easily shown, by induction, that when considering a P -order controller $u_{d,r}^{\delta P}$ the Lyapunov difference can be bounded as follows

$$V(x_{k+1}) - V(x_k) \leq -\delta\rho_4(\|x_k\|) + O(\delta^{P+r}) \quad (3.29)$$

In the case of higher relative degrees, the problem of designing stabilizing continuous-time controllers is solved by making reference to a backstepping procedure.

3.5 MIMO SYSTEMS

In this section, the previous solutions are extended to the case of **MIMO** systems. In the context of the input/Lyapunov matching we are interested in providing more general results for a system that has m inputs and for which there are defined l Lyapunov functions. There are situations that are included into this category: systems in strict-feedback or feedforward forms [Sepulchre *et al.* 1997] where multiple Lyapunov functions are involved in the stabilizing design strategy.

Compared with the **SISO** model (1.2), m vector fields g_i describe the forced evolution of the system. Let us make the following notations: $\bar{u} = [u_1, u_2, \dots, u_m]^T$, $\bar{g} = [g_1, g_2, \dots, g_m]$, $\bar{V} = [V_1, V_2, \dots, V_l]^T$. By using the definition and computations given in the Appendix 13 then the formal series equality (3.5) is extended as a matrix of l equalities:

$$\delta Q_i(x_k, \delta, \bar{u}_k) = e^{\delta(f(\cdot) + \bar{u}_k \bar{g}(\cdot))} V_i|_{x_k} - e^{\delta(f(\cdot) + \bar{u}_c(\cdot) \bar{g}(\cdot))} V_i|_{x_k} = 0. \quad (3.30)$$

with $i = 1, l$ and $\bar{u}_k = [u_{1k}, u_{2k}, \dots, u_{mk}]^T$. Each u_{ik} defined as follows:

$$\bar{u}_k = \bar{u}_d^{\delta P} = \bar{u}_{d0} + \sum_{i=1}^{i=P} \frac{\delta^i}{(i+1)!} \bar{u}_{di}. \quad (3.31)$$

where each \bar{u}_{di} is a vector with l elements $[u_{dij}]$. Hence, the system (3.30) has a number of $l \times P$ equations and $m \times P$ controllers terms to be found. This system is linear in the unknown variables.

More complex calculus, give the following solutions for the controller terms in the most general case of *MIMO* systems³:

$$\left\{ \begin{array}{l} L_{\bar{g}}\bar{V}(x_k) \cdot \bar{u}_{d0} = L_{\bar{g}}\bar{V}(x_k) \cdot \bar{u}_c(x_k); \\ L_{\bar{g}}\bar{V}(x_k) \cdot \bar{u}_{d1} = L_{\bar{g}}\bar{V}(x_k) \cdot \dot{\bar{u}}_c(x_k); \\ L_{\bar{g}}\bar{V}(x_k) \cdot \bar{u}_{d2} = (L_{\bar{g}}\bar{V}(x_k) \cdot \ddot{\bar{u}}_c + \frac{1}{2}(L_{[f,\bar{g}]}\bar{V}(x_k) \cdot \bar{u}_{d1}))|_{x_k}; \\ L_{\bar{g}}\bar{V}(x_k) \cdot \bar{u}_{d3} = (L_{\bar{g}}\bar{V}(x_k) \cdot \ddot{\bar{u}}_c + (L_f L_{[f,\bar{g}]}\bar{V}(x_k) - L_{\bar{g}}^2 L_f \bar{V}(x_k) + (L_f L_{\bar{g}}^2 \bar{V}(x_k) - L_{\bar{g}}^2 L_f \bar{V}(x_k)) \odot \bar{u}_{d0})\bar{u}_{d1} - \\ \quad - 2(L_f L_{\bar{g}} \bar{V}(x_k) + L_{\bar{g}} L_f \bar{V}(x_k) + 4L_{\bar{g}}^2 \bar{V}(x_k) \odot \bar{u}_{d0})\bar{u}_{d2} + \\ \quad + (3L_f L_{\bar{g}} \bar{V}(x_k) + L_{\bar{g}} L_f \bar{V}(x_k) + 4L_{\bar{g}}^2 \bar{V}(x_k) \odot \bar{u}_{d0})\ddot{\bar{u}}_c)|_{x_k} \end{array} \right. \quad (3.32)$$

In this case a unique solution can not be ensured. For specific details we give next a discussion in function of the values of l and m .

3.5.0.1 Square *MIMO* systems

For the *MIMO* case, we consider the *square* systems where $m = l$ (the number of control inputs is equal to the number of the Lyapunov functions). A practical example for $l = m = 2$ can be met in [Mattei & Monaco 2012].

By using the expressions (3.32) for this case, we can compute a unique solution for the controller terms only if the square matrix $L_{\bar{g}}\bar{V}$ is invertible (which corresponds to assume that the relative degree 1 with respect to V of the *MIMO* system).

$$\left\{ \begin{array}{l} \bar{u}_{d0} = \bar{u}_c(x_k); \\ \bar{u}_{d1} = \dot{\bar{u}}_c(x_k); \\ \bar{u}_{d2} = (\ddot{\bar{u}}_c + \frac{1}{2}L_{\bar{g}}\bar{V}^{-1}(L_{[f,\bar{g}]}\bar{V} \cdot \bar{u}_{d1}))|_{x_k}; \\ \bar{u}_{d3} = (\ddot{\bar{u}}_c + L_{\bar{g}}\bar{V}^{-1}((L_f L_{[f,\bar{g}]}\bar{V} - L_{\bar{g}}^2 L_f \bar{V} + (L_f L_{\bar{g}}^2 \bar{V} - L_{\bar{g}}^2 L_f \bar{V}) \odot \bar{u}_{d0})\bar{u}_{d1} - \\ \quad - 2(L_f L_{\bar{g}} \bar{V} + L_{\bar{g}} L_f \bar{V} + 4L_{\bar{g}}^2 \bar{V} \odot \bar{u}_{d0})\bar{u}_{d2} + \\ \quad + (3L_f L_{\bar{g}} \bar{V} + L_{\bar{g}} L_f \bar{V} + 4L_{\bar{g}}^2 \bar{V} \odot \bar{u}_{d0})\ddot{\bar{u}}_c)|_{x_k} \end{array} \right. \quad (3.33)$$

In the *square MIMO* case the computations are similar to those performed in the *SISO* case thanks to the extended notations.

³ The \odot operator is defined in the Appendix 13

MIMO RELATIVE DEGREE Now we have to extend the definition of relative degree from the **SISO** to the **MIMO** system case. In this case we have to define a *vector relative degree* [Isidori 1995]. First we define the relative degree matrix $L_{\bar{g}}L_f^{\bar{\gamma}}\bar{V}$ as

$$L_{\bar{g}}L_f^{\bar{\gamma}}\bar{V} = \begin{bmatrix} L_{g_1}L_f^{\gamma_1-1}V_1 & L_{g_2}L_f^{\gamma_1-1}V_1 & \cdots & L_{g_m}L_f^{\gamma_1-1}V_1 \\ L_{g_1}L_f^{\gamma_2-1}V_2 & L_{g_2}L_f^{\gamma_2-1}V_2 & \cdots & L_{g_m}L_f^{\gamma_2-1}V_2 \\ \vdots & \vdots & \ddots & \vdots \\ L_{g_1}L_f^{\gamma_p-1}V_p & L_{g_2}L_f^{\gamma_p-1}V_p & \cdots & L_{g_m}L_f^{\gamma_p-1}V_p \end{bmatrix} \in \mathbb{R}^{l \times m} \quad (3.34)$$

Definition 37. The square **MIMO** system has vector relative degree $\bar{\gamma} = [\gamma_1 \ \gamma_2 \ \dots \ \gamma_p]$ at x_0 if

$$L_{g_j}L_f^k V_i(x) = 0, \quad 0 \leq k \leq \gamma_i - 2, \quad j \neq i \quad (3.35)$$

for $i = 1, \dots, l$ and the matrix $L_{\bar{g}}L_f^{\bar{\gamma}}\bar{V}(x_0)$ is nonsingular.

If the system has a well defined vector relative degree, then it can be written as:

$$\begin{bmatrix} V_1^{(\gamma_1)} \\ V_2^{(\gamma_2)} \\ \vdots \\ V_p^{(\gamma_p)} \end{bmatrix} = \begin{bmatrix} L_f^{\gamma_1} V_1 \\ L_f^{\gamma_2} V_2 \\ \vdots \\ L_f^{\gamma_p} V_p \end{bmatrix} + L_{\bar{g}}L_f^{\bar{\gamma}}\bar{V}(x) \begin{bmatrix} u_1 \\ u_2 \\ \vdots \\ u_p \end{bmatrix} \quad (3.36)$$

For this case it is said that the system is *decoupled* under a linearizing state-feedback. For this reason a large number of results from the **SISO** case can be easily extended to this class of **MIMO** nonlinear systems. The problems that can arise are when the system does not have a well defined vector relative degree (the matrix (3.34) is singular). The results given in (3.33) are valid for a vector relative degree with all degrees equal to 1. For any other value of the elements of the vector relative degree then the equalities (3.30) have to be evaluated for each $i = 1, l$ and new controller terms have to be identified.

3.5.0.2 The case $m > l$

In this case the number of Lyapunov functions l is smaller than the number of control inputs m . This is for example the case of a marine vessel control problem studied in [Tiefensee 2010]. We notice that the control solution is not unique, so it occur a problem of choosing one of the many solutions available. A solution is to build the matrix (3.34) by choosing the l inputs that ensure the invertibility of the matrix. With the remaining inputs we can impose additional performance (in some sense the control has extra liberty degrees for design).

An appropriate solution is to compute the pseudoinverse of $L_{\bar{g}}\bar{V}$. Let us define the matrix $L_{\bar{g}}\bar{V}^+ \in \mathbb{R}^{m \times l}$ such that $L_{\bar{g}}\bar{V}^+L_{\bar{g}}\bar{V} = 1_{m \times m}$. The sampled-data control is defined now by,

$$\left\{ \begin{array}{l} \bar{u}_{d0} = \bar{u}_c(x_k); \\ \bar{u}_{d1} = \dot{\bar{u}}_c(x_k); \\ \bar{u}_{d2} = (\ddot{\bar{u}}_c + \frac{1}{2}L_{\bar{g}}\bar{V}^+(L_{[f,\bar{g}]} \bar{V} \cdot \bar{u}_{d1}))|_{x_k}; \\ \bar{u}_{d3} = (\ddot{\bar{u}}_c + L_{\bar{g}}\bar{V}^+((L_f L_{[f,\bar{g}]} \bar{V} - L_{\bar{g}}^2 L_f \bar{V} + (L_f L_{\bar{g}}^2 \bar{V} - L_{\bar{g}}^2 L_f \bar{V}) \odot \bar{u}_{d0})\bar{u}_{d1} - \\ - 2(L_f L_{\bar{g}} \bar{V} + L_{\bar{g}} L_f \bar{V} + 4L_{\bar{g}}^2 \bar{V} \odot \bar{u}_{d0})\bar{u}_{d2} + \\ + (3L_f L_{\bar{g}} \bar{V} + L_{\bar{g}} L_f \bar{V} + 4L_{\bar{g}}^2 \bar{V} \odot \bar{u}_{d0})\ddot{\bar{u}}_c)|_{x_k} \end{array} \right. \quad (3.37)$$

There are many solutions to compute the pseudoinverse. We choose the Moore-Penrose pseudoinverse matrix definition. For this case

$$L_{\bar{g}}\bar{V}^+ = (L_{\bar{g}}\bar{V}^T L_{\bar{g}}\bar{V})^{-1} L_{\bar{g}}\bar{V}^T, \text{ only if } (L_{\bar{g}}\bar{V}^T L_{\bar{g}}\bar{V}) \text{ invertible} \quad (3.38)$$

3.5.0.3 The case $m < l$

In this case the number of control inputs is smaller than the number of Lyapunov functions defined. This is often the case of backstepping control, detailed in the following chapter. The backstepping design provides a recursive design for computing successive Lyapunov functions, for a system with only one input. The number of Lyapunov functions defined in a such strategy depends on the dimension of the dynamics. In the present context of digital control design two strategies can be adopted.

The first solution is to set the problem of input/Lyapunov matching on m Lyapunov functions only, so that the relative degree matrix (3.34) to be square and invertible. Typically when $m = 1$, when a backstepping procedure is used, then for the digital design it requires to match the last Lyapunov function resulted in the design.

A second solution is to count for the contribution of all l Lyapunov functions. In this case two solutions can be derived.

- a solution that use a pseudoinverse as in the case of $m > l$;
- another solution is to add extra freedom degrees in the control variables -multi rate control - to get a full rank relative degree matrix of order l ; this idea is typically used in the multi-rate design.

DIGITAL BACKSTEPPING CONTROL VIA INPUT/LYAPUNOV MATCHING

This chapter describes two approaches for designing digital controllers for systems admitting backstepping stabilizing feedback laws. These two designs procedures recover in a sampled-data context the stabilizing properties of the ideal continuous-time backstepping controllers. These approaches are based on the concept of input-Lyapunov matching. In the first section the continuous-time backstepping procedure is recalled for a system with one or multiple cascade connections. These two digital designs procedures, the single-rate and multi-rate designs respectively, are developed for one or multiple cascade connections respectively. An example is worked out through this chapter to illustrate the concepts and the successive steps. Part of the results reported here are included in the paper [C02],[S1],[P2] from the author's contribution list (page ix).

4.1 THE OBJECTIVE

The backstepping strategy is nowadays frequently used in the control design of nonlinear systems admitting strict feedback form¹. These specific state space forms are used to model electro-mechanical systems. In particular, a typical difficulty of these structures is to exhibit a relative degree larger than one. This constitutes an obstacle in designing passivity based controllers and the backstepping procedure is a suitable tool to remove this obstacle.

The backstepping procedure, in its general formulation, gives the ingredients to compute controllers that stabilize the origin globally. Although this method can be compared with other state-feedback designs like dynamical linearization, its particularity is that the backstepping procedure takes into consideration the nonlinearity which can be useful for stabilization. It does a priori not cancel the nonlinearity since which can be included then into the controller.

¹ See the general definition in [Section 4.2.2](#)

The main drawback of this procedure, highlighted when the number of cascade connections is large is that the controller expressions become quite complex. To cope with this, some relaxing procedures are proposed, which achieve semiglobal results such as high-gain designs or semiglobal backstepping [Sepulchre *et al.* 1997].

As this procedure has a major impact in many applications, it is clear that in real-time systems, the problem of designing digital controllers that preserve the performances of the continuous-time controller is demanded. This is the objective of this chapter.

In this chapter two strategies for designing digital backstepping controllers are proposed by using the input/Lyapunov matching criteria (see Chapter 3). Thus, we can improve the stabilization performances compared with the classical emulation of the continuous-time controllers.

A first attempt consists in computing a single-rate digital controller u_k so that to reproduce the Lyapunov function V evolution set in the ideal continuous-time case at the sampling instants. It follows that the continuous-time controller performances, including the stabilizing one, are preserved through digital design. This strategy is depicted in Figure 4.1.

On the top of the figure, the continuous-time plant is represented. The Lyapunov function V evolution, expressed in terms of the system states variables, represents the stabilizing characteristic of the plant under the continuous-time backstepping controller. On the bottom of the figure, a discrete controller is applied on the same plant. The states are sampled at a sampling period equal to δ , and the controller computes a new value at each δ seconds.

A second strategy makes reference to a multi-rate design where $\delta = m\bar{\delta}$. It imposes additional objectives when designing the digital controller, in order to improve the stabilizing properties.

The results presented through this chapter are then generalized to systems with multiple cascade connections.

4.2 CONTINUOUS-TIME BACKSTEPPING- ONE CASCADE CONNECTION CASE

Let us consider first, a 2 sub-systems connection as follows

$$\dot{z}(t) = f(z(t)) + g(z(t))\xi(t) \quad (4.1)$$

$$\dot{\xi}(t) = a(z(t), \xi(t)) + b(z(t), \xi(t))u_c(t) \quad (4.2)$$

where the states z and ξ are in \mathbb{R}^n and \mathbb{R} respectively and the control vector $u_c \in \mathbb{R}$, f, g and $a(\cdot), g(\cdot)$ in \mathbb{R}^n and in \mathbb{R} respectively.

The following result describes the stabilizing controller through the backstepping approach. The constructive aspects are recalled when they are instrumental for the digital implementation.

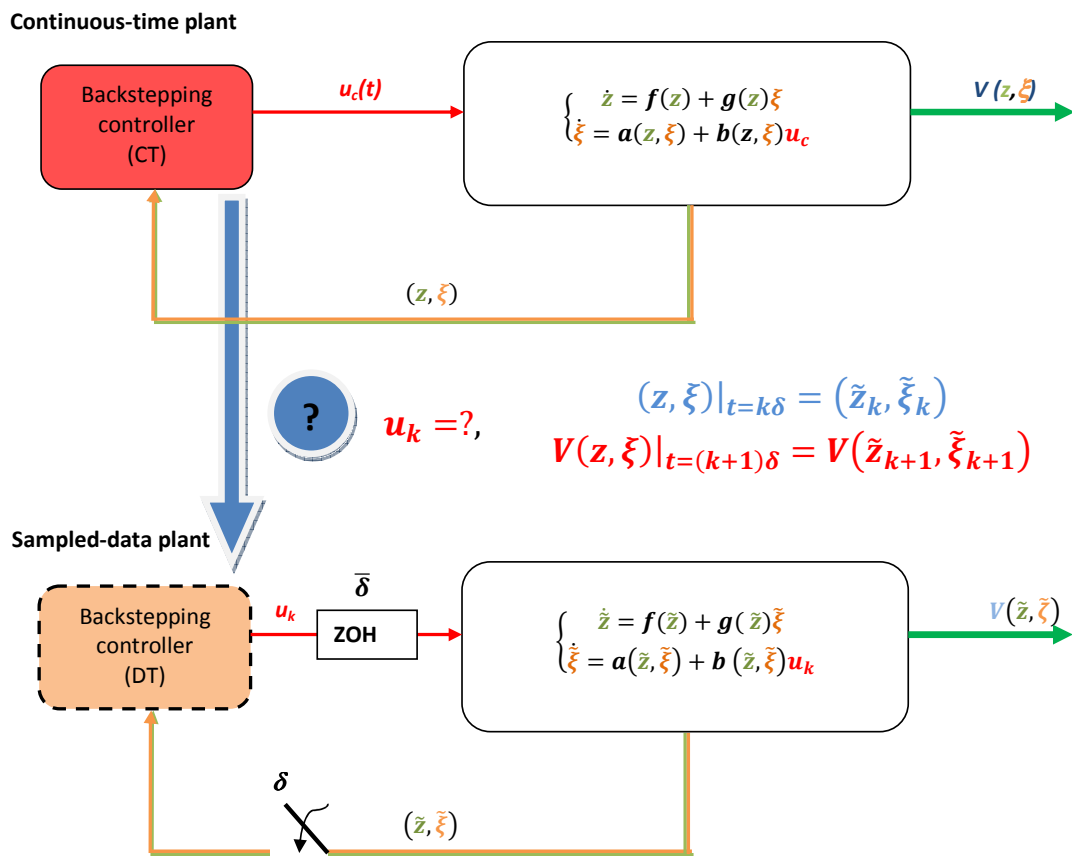

Figure 4.1: The input/Lyapunov matching criteria

Proposition 38. [Khalil 1996] - Continuous-time backstepping - Consider the system (4.1)-(4.2), and suppose the existence of $\phi(z)$ with $\phi(0) = 0$ and a Lyapunov function $W(z)$, radially unbounded, such that

$$\frac{\partial W}{\partial z}(f(z) + g(z)\phi(z)) < 0, \forall z \in \mathbb{R}^n / \{0\}. \quad (4.3)$$

Then, if $b^{-1}(z, \xi)$ exists for all (z, ξ) , the state feedback control law

$$u_c = b(z, \xi)^{-1} \left(\dot{\phi} - \frac{\partial W}{\partial z} g(z) - a(z, \xi) - K_y(\xi - \phi) \right) \quad (4.4)$$

with $\dot{\phi} = \frac{\partial \phi}{\partial z}(f(z) + g(z)\xi)$ globally asymptotically stabilizes the origin of (4.1)-(4.2), with

$$V(z, \xi) = W(z) + \frac{1}{2}(\xi - \phi(z))^2 \quad (4.5)$$

as a Lyapunov function.

Proof. By considering $\phi(z)$ as a fictitious control for the first z -dynamics, it follows from (4.3) that the fictitious state feedback $\xi = \phi(z)$ asymptotically stabilizes the dynamics (4.1) at the origin. Setting $y = \xi - \phi(z)$, (4.1)-(4.2) can be rewritten as

$$\dot{z}(t) = f(z) + g(z)(\phi(z) + y) \quad (4.6)$$

$$\dot{y}(t) = a(z, \xi) - \frac{\partial \phi}{\partial z} \dot{z} + b(z, \xi)u_c, \quad (4.7)$$

thus describing the second part as an y -error dynamics. By setting V as in (4.5) and

$$u_c = b^{-1}(z, \xi) \left(-a(z, \xi) - y_0 + \frac{\partial \phi}{\partial z}(f(z) + g(z)\xi) + v \right) \quad (4.8)$$

one achieves $v \rightarrow y$ passivity with storage function V . Then, by setting $v = -K_y y$ with $K_y > 0$, one gets (4.4) so that

$$\dot{V} = \frac{\partial W}{\partial z}(f(z) + g(z)\phi) + \frac{\partial W}{\partial z} g(z)y + y^T(v - y_0) = \frac{\partial W}{\partial z}(f(z) + g(z)\phi) - K_y y^T y < 0 \quad (4.9)$$

because of (4.3). The global asymptotic stabilization at the origin follows, since $W(z)$ is radially unbounded. \square

Remark 39. The statement of Proposition 38 can be formulated also locally and the origin becomes locally asymptotically stable. The condition of radially unbounded of the Lyapunov function W is not required in this case.

Some comments are helpful for the digital design: The controller u_c achieves different goals, it improves damping through the negative gain output feedback and it renders the link $v \rightarrow y$ passive.

Moreover, by substituting at the first step $\xi = \phi$ with $\xi = \phi + v_0$, the condition (4.3) guarantees passivity of the link $v_0 \rightarrow y_0$ with

$$y_0^T := \frac{\partial W}{\partial z} g(z).$$

and storage function W .

According to [Sepulchre *et al.* 1997] the output error y of the closed-loop system (4.1)-(4.2) under (4.8) is ZSD from the input v into the output y if and only if (4.1) on $\xi = \phi$ is ZSD for the input v_0 to y_0 . If the ZSD property holds then the condition (4.3) can be relaxed to negative semi-definiteness.

These interpretations through passivation of the backstepping procedure make clear that the loss of passivity under sampling should destroy the stabilizing performance of the digital implementation of u_c through emulation. In fact, setting $u_c(t) = u_k$ (constant over an interval), the negativity of \dot{V} , over the inter-sampling, is no longer guaranteed as explained in [Tiefensee *et al.* 2009]. Several digital strategies can be proposed. Starting from (4.1)-(4.2) and recalling that backstepping has been introduced to remove the relative degree as an obstacle to passivation, one notes that, under sampling the dynamics of z has relative degree one compared to the continuous-time case, when it is equal to 2. It results that passivation through piecewise constant control of the discrete-time equivalent should be possible. However, this sets another difficulty linked to the fact that passivity in discrete-time relies on systems with direct input-output link only.

4.2.1 Example 3 (continuous-time design)

Let us illustrate the design on a simple example and consider first the strict-feedback system of order 2:

$$\dot{x}_1(t) = x_1^2(t) + x_2(t) \quad (4.10)$$

$$\dot{x}_2(t) = u(t) \quad (4.11)$$

On a **first step**, there are chosen the Lyapunov function $W(x_1)$ and the function $\phi_1(z)$ with $\phi_1(0) = 0$, such that the condition (4.3) is satisfied. A convenient choice is :

$$W(x_1) = \frac{1}{2}x_1^2, \quad (4.12)$$

$$\phi_1(x_1) = -x_1 - x_1^2, \quad (4.13)$$

In this case, the stability of x_1 dynamics with the fictitious control $x_2 = \phi_1(x_1)$ is ensured since,

$$\dot{W} = x_1(-x_1) = -x_1^2 < 0, \quad \forall x_1 \in \mathbb{R}/0 \quad (4.14)$$

On the **second step** a change of coordinates is necessary $y_1 = x_2 - \phi_1(x_1)$. The system is rewritten as,

$$\dot{x}_1 = -x_1 + y_1 \quad (4.15)$$

$$\dot{y}_1 = -(1 + 2x_1)(x_1 - y_1) + u \quad (4.16)$$

The new Lyapunov function is given by

$$V_1 = W + \frac{1}{2}y_1^2 = \frac{1}{2}(x_1^2 + y_1^2). \quad (4.17)$$

The stabilizing controller is,

$$u_c = (1 + 2x_1)(x_1 - y_1) - x_1 - K_1 y_1. \quad (4.18)$$

By setting $K_1 = 1$ and translating into initial coordinates, then

$$u_c = -2(x_1 + x_2 + x_1 x_2 + x_1^2 + x_1^3). \quad (4.19)$$

STABILITY ANALYSIS Now let us consider that $x_2 = \phi(x_1) + v_0$ and $y_0 = \frac{\partial W}{\partial z} = x_1$, then the first dynamics (4.10) becomes

$$\dot{x}_1 = -x_1 + v_0 \quad (4.20)$$

and $\dot{W} = -x_1^2 + x_1 v_0 \leq v_0 y_0$ which is the condition of the passivity link v_0/y_0 .

If one considers that $v = u_c - (1 + 2x_1)(x_1 - y_1) - x_1$ and $y = \frac{\partial V_1}{\partial [x_1, y_1]} = y_1$ then the initial system becomes in the x_1, y_1 coordinates:

$$\dot{x}_1 = -x_1 + y_1 \quad (4.21)$$

$$\dot{y}_1 = -x_1 + v \quad (4.22)$$

The passivity condition of the link v/y is satisfied since:

$$\dot{V}_1 = -x_1^2 + v y \leq v y, \forall x_1 \in \mathbb{R}^n. \quad (4.23)$$

Under sampling, when one considers that u_k is kept constant over the interval $[k\delta, (k+1)\delta]$ (emulated control) then the inequality (4.23) becomes through integrations:

$$\int_{t=k\delta}^{(k+1)\delta} \dot{V}_1(t) dt \leq \int_{t=k\delta}^{(k+1)\delta} v(t)y(t) dt \quad (4.24)$$

As u_k constant also $v = v_k$ over the sampling interval, then

$$V_1((k+1)\delta) - V_1(k\delta) \leq v_k \int_{\tau=0}^{\delta} y(k\delta + \tau) d\tau \quad (4.25)$$

Some computations give

$$V_1((k+1)\delta) - V_1(k\delta) = \delta(-x_1^2 + v_k y_1) + \frac{\delta^2}{2}(1 - 2x_1^2 - 2x_1 y_1 - x_1 v_k + v_k^2) + O_1(\delta^3) \quad (4.26)$$

respective

$$\int_{\tau=0}^{\delta} y(k\delta + \tau) d\tau = \delta y_1 + \frac{\delta^2}{2}(v_k - x_1) + O_2(\delta^3) \quad (4.27)$$

Now we can see that the inequality (4.25) holds with an error in $O(\delta^2)$:

$$-\delta x_1^2 \leq -\frac{\delta^2}{2}(1 - 2x_1^2 - 2x_1 y_1) + O_2(\delta^3) - O_1(\delta^3) \quad (4.28)$$

It is clear that the emulation can not assure the passivity - and consequently the stabilization - for any δ . The same conclusion can be drawn for the first link v_0/y_0 where the inequality holds with a smaller error - $O(\delta^3)$.

4.2.2 A constructive solution for the multiple cascade connections

The continuous-time backstepping procedure can be applied, in a constructive way, to compute the stabilizing controller for a strict-feedback system with more than one cascade connexion. Let us consider the following triangular configuration:

$$\begin{aligned} \dot{z}(t) &= f(z(t)) + g(z(t))\xi_1(t) \\ \dot{\xi}_1(t) &= a_1(z(t), \xi_1(t)) + b_1(z(t), \xi_1(t))\xi_2(t) \\ &\vdots \\ \dot{\xi}_{m-1}(t) &= a_{m-1}(z(t), \xi_1(t), \dots, \xi_{m-1}(t)) + b_{m-1}(z(t), \xi_1(t), \dots, \xi_{m-1}(t))\xi_m(t) \\ \dot{\xi}_m(t) &= a_m(z(t), \xi_1(t), \dots, \xi_m(t)) + b_m(z(t), \xi_1(t), \dots, \xi_m(t))u(t) \end{aligned} \quad (4.29)$$

with states $z \in \mathbb{R}^n$ and $\xi_i \in \mathbb{R}$, all functions are considered at least of class C^1 and all $b_i(\cdot)$ are invertible for all (z, ξ_1, \dots, ξ_m) .

On a first step, let us take the virtual output as $y_1 = \xi_1 - \alpha_1(z)$, then the system has relative degree $m + 1$ related to this output. In a recursive manner, by following the backstepping procedure, for each step a new virtual output y_i is defined as $y_i = \xi_i - \alpha_i(z, \xi_1, \dots, \xi_{i-1})$ with a fictitious controller α_i such that each Lyapunov function

$$V_i = W + \frac{1}{2} \left(\sum_{j=1}^{i-1} y_j^2 \right) \quad (4.30)$$

ensures the stability properties of the first i connections. Each α_i can be constructed as:

$$\alpha_i = \frac{1}{b_{i-1}(\cdot)} \left(\dot{\alpha}_{i-1}(\cdot) - a_{i-1}(\cdot) - \frac{\partial V_{i-1}}{\partial y_{i-1}} b_{i-2}(\cdot) - K_i y_i \right), \quad \forall i > 2, \quad K_i > 0$$

with $\alpha_1 = -K_1 y_1$ and α_2 as given in (4.8). On the final step the controller $u_c = \alpha_{m+1}(\cdot)$ is obtained, with the passivating output for the whole system, taken as $y_m = \xi_m - \alpha_m(\cdot)$. Related to this output the system with the $\alpha_{m+1}(\cdot)$ as control input, has now relative degree 1.

4.2.3 Example 4 (continuous-time design)

Let us add to the system, given in the previous example, an integrator in the controls input path:

$$\dot{x}_1(t) = x_1^2(t) + x_2(t) \quad (4.31)$$

$$\dot{x}_2(t) = x_3(t) \quad (4.32)$$

$$\dot{x}_3(t) = u(t). \quad (4.33)$$

In this case three steps are considered in order to construct the stabilizing controller. The first two steps are already detailed in the previous example. For the dynamics (4.31) are defined W as in (4.12) and $\phi_1(x_1)$ as in (4.13), respectively. For the second dynamic (4.32), the V_1 is defined in (4.17) with $y_1 = x_2 - \phi_1(x_1)$, and $\phi_2(x_1, y_1)$ stands for the previous u_c :

$$\phi_2(x_1, y_1) = (1 + 2x_1)(x_1 - y_1) - x_1 - K_1 y_1. \quad (4.34)$$

For the final step, a new change of coordinates is required : $y_2 = x_3 - \phi_2(x_1, y_1)$. Then the initial system becomes:

$$\dot{x}_1 = -x_1 + y_1 \quad (4.35)$$

$$\dot{y}_1 = -x_1 - K_1 y_1 + y_2 \quad (4.36)$$

$$\dot{y}_2 = u - \dot{\phi}_2(x_1, y_1) \quad (4.37)$$

where

$$\dot{\phi}_2(x_1, y_1) = \frac{\partial \phi_2(x_1, y_1)}{\partial x_1} \dot{x}_1 + \frac{\partial \phi_2(x_1, y_1)}{\partial y_1} \dot{y}_1.$$

The controller is now given by,

$$u_c = \dot{\phi}_2(x_1, y_1) - y_1 - K_2 y_2 \quad (4.38)$$

The stabilization is also ensured with a Lyapunov function $V_2 = \frac{1}{2}(x_1^2 + y_1^2 + y_2^2)$ and its derivative satisfies:

$$\dot{V}_2 = -x_1^2 - K_1 y_1^2 - K_2 y_2^2 \leq 0, \quad \forall x_1, y_2, y_3 \in \mathbb{R}.$$

By taking $K_1 = K_2 = 1$, the controller expressed into the initial coordinates is:

$$u_c(x_1, x_2, x_3) = -6x_1^4 - 6x_1^3 + (-8x_2 - 5)x_1^2 + (-6x_2 - 2x_3 - 3)x_1 - 2x_2^2 - 5x_2 - 3x_3 \quad (4.39)$$

4.3 SAMPLED-DATA BACKSTEPPING UNDER SINGLE-RATE DESIGN

Let $x^T = [z^T \ y^T]^T$ be the state of the transformed system (4.6)-(4.7) rewritten as

$$\dot{x}(t) = f_c(x(t)) + g_c(x(t))u_c(t) \quad (4.40)$$

with

$$f_c = \begin{bmatrix} f(z) + g(z)(\phi(z) + y) \\ a(z, y + \phi(z)) - \frac{\partial \phi}{\partial z} \dot{z} \end{bmatrix}, \quad g_c = \begin{bmatrix} 0 \\ b(z, y + \phi(z)) \end{bmatrix}.$$

Let us assume $u_c(t) = u_k$ over each interval of length δ , then the sampled-data equivalent of equation (4.40) is described by

$$x_{k+1} = F_d^\delta(x_k, u_k) = e^{\delta(f_c + u_k g_c)} x_k \quad (4.41)$$

where F_d^δ is given in (1.19). Given u_c as in (4.4), the Lyapunov function $V(z, \xi)$ with negative time-derivative set as in (4.9), one computes through integration:

$$V(x_c(t = (k+1)\delta)) - V(x_c(t = k\delta)) = \int_{k\delta}^{(k+1)\delta} \dot{V}(x_c(\tau)) d\tau, \quad (4.42)$$

where x_c indicates the closed loop continuous-time x -dynamics under u_c as in (4.4). The equality (4.42) indicates the continuous-time target difference.

Next we are interested in applying the input/Lyapunov matching criteria to the context of backstepping controller. This means that the sampled-data redesign consists in computing a piecewise constant control law u_k to match, at each sampling instant, (4.42). That is, u_k must verify :

$$V(x_{k+1}) - V(x_k) = \int_{k\delta}^{(k+1)\delta} \dot{V}(x_c(\tau)) d\tau. \quad (4.43)$$

where $x_k = x_c(t = k\delta)$ and x_{k+1} is computed from (4.41). Hence the digital control u_k reproduces, at the sampling instants, the Lyapunov performance of the continuous-time closed loop system and achieves asymptotic stabilization of the sampled system for small enough sampling periods.

Theorem 40. [*Tiefensee 2010*] Consider a strict-feedback system of the form (4.1)-(4.2), and suppose the existence of a continuous-time controller u_c , computed from a backstepping procedure, such that a Lyapunov function V exists, which guarantees the stability of the initial system. Then there exists $T^* > 0$ such that for any δ in $(0, T^*]$ there exists a digital feedback $u_k = u_d^\delta$ which ensures the same Lyapunov evolution under sampling and guarantees the asymptotic stability of the sampled-data equivalent system.

Proof. Since the theorem is a direct application of Theorem 32 the proofs are identical. The particularity in this case is the condition of the solution existence that is now given by $L_{g_c} V|_{x_k} = b(z, y + \phi)y \neq 0$ for all $y \neq 0$ with g_a invertible. \square

Remark 41. The previous theorem can be formulated globally or locally depending on the assumptions taken for the design of the continuous-time controller.

4.3.1 Controller computations

The terms of u_d^δ are given by the expressions (3.8)-(3.11). In this context the controllers can be computed more accurately as follows:

$$u_{d0}(z_k, y_k) = u_c(z, y)|_{t=k\delta} \quad (4.44)$$

$$\begin{aligned} u_{d1}(z_k, y_k) &= \dot{u}_c(z, y)|_{t=k\delta} \\ &= \frac{\partial u_c(z, y)}{\partial z} (f(z) + g(z)(\phi(z) + y))|_{t=k\delta} \\ &\quad + \frac{\partial u_c(z, y)}{\partial y} (a(z, y + \phi(z)) - \dot{\phi}(z))|_{t=k\delta} \end{aligned} \quad (4.45)$$

$$u_{d2}(z_k, y_k) = \ddot{u}_c(z, y)|_{t=k\delta} + \frac{u_{d1}(z_k, y_k)}{2b(z, y + \phi(z))y} \text{ad}_{[f_c, g_c]} V|_{t=k\delta}. \quad (4.46)$$

with

$$\begin{aligned} \text{ad}_{[f_c, g_c]} V|_{t=k\delta} &= \frac{\partial b(z, y + \phi(z))}{\partial z} y (f(z) + g(z)(\phi(z) + y))|_{t=k\delta} \\ &\quad + \left(b(z, y + \phi(z)) + y \frac{\partial b(z, y + \phi(z))}{\partial y} \right) (a(z, y + \phi(z))(z))|_{t=k\delta} \\ &\quad - \left(\frac{\partial W}{\partial z} (f(z) + g(z)) + \frac{\partial a(z, y + \phi(z))}{\partial y} (z) \right) b(z, y + \phi(z))|_{t=k\delta} \end{aligned} \quad (4.47)$$

These expressions are well defined since according to the backstepping procedure $b(z + \phi(z))y \neq 0$. To express this solution into initial condition a coordinate change with $y := \xi - \phi(z)$ is necessary.

We redirect the reader to section 3.2, for details regarding the stabilizing properties of this controller.

4.3.2 Example 3 - the sampled-data design

Let us apply the digital procedure on the example provided in the section 4.2.1. By replacing variable x_1 with z_1 and y_2 with z_2 , the system (4.15)-(4.16) is rewritten in the general form (4.40) as:

$$f_c = \begin{bmatrix} -z_1 + z_2 \\ -(1 + 2z_1)(z_1 - z_2) \end{bmatrix}, \quad g_c = \begin{bmatrix} 0 \\ 1 \end{bmatrix}$$

and the continuous-time control,

$$u_c = (1 + 2z_1)(z_1 - z_2) - z_1 - z_2.$$

By using the design formulas for the sampled-data controller (4.44)-(4.46), then $u_d^\delta = u_{d0} + \delta/2 u_{d1} + \delta^2/6 u_{d2}$, with

$$u_{d0} = u_c|_{t=k\delta} = (1 + 2z_{1k})(z_{1k} - z_{2k}) - z_{1k} - z_{2k} \quad (4.48)$$

$$u_{d1} = \dot{u}_c|_{t=k\delta} = 2(z_{1k} + z_{2k} - z_{2k}^2 - z_{1k}^2 + 4z_{1k}z_{2k}) \quad (4.49)$$

respectively u_{d2} which is computed from

$$u_{d2} = \ddot{u}_c|_{t=k\delta} + \frac{u_{d1}}{2} \frac{L_{f_c} L_{g_c} V_2 - L_{g_c} L_{f_c} V_2}{L_{g_c} V_2} |_{t=k\delta} = \ddot{u}_c|_{t=k\delta} - \frac{u_{d1}}{2} \frac{z_{1k} - 3z_{2k} - 6z_{1k}z_{2k} + 4z_{1k}^2}{z_{2k}}$$

with

$$\ddot{u}_c(z_k) = -4(z_{1k} + 2z_{1k}z_{2k} - 2z_{2k}^2).$$

This controller assures the reproduction of $V_2(z_1, z_2)$ in the sense that the equality (4.43) holds with an error in $O(\delta^3)$.

4.3.3 Sampled-data solution for the multiple cascade connexions

The same controller construction can be applied for the case of multiple sub-systems. Denoting now by $x^T = [z^T \ y_1 \ y_2 \ \dots \ y_m]$, the compact system (4.40) is defined by:

$$f_c = \begin{bmatrix} f(z) + g(z)(y_1 + \alpha_1(z)) \\ a_1(z, y_1 + \alpha_1(z)) - \dot{\alpha}_1(z) + b_1(z, y_1 + \alpha_1(z))(y_2 + \alpha_1(z, y_1 + \alpha_1(z))) \\ \vdots \\ a_m(z, y_1 + \alpha_1(z), \dots, y_m + \alpha_m(z, \cdot)) - \dot{\alpha}_m(z, \cdot) \end{bmatrix}$$

$$g_c = [0 \ 0 \ \dots \ b_n(z, y_1 + \alpha_1(z), \dots, y_m + \alpha_m(z, \cdot))]$$

where the time-derivatives of $\alpha_i(z, \cdot)$ are evaluated as explicit functions of the state variables that it depends on, e.g. $\dot{\alpha}_1(z) = \frac{\partial \alpha_1}{\partial z} (f(\cdot) + g(\cdot)(y_1 + \alpha_1(z)))$. The Lyapunov function V is expressed as,

$$V = W + \frac{1}{2} \sum_{j=2}^m x_j^2 \quad (4.50)$$

The sampled controller is computed in the same manner as in the previous case with the new given functions.

4.3.4 Example 4 - the sampled-data design

By using the same notation z for the state vector $[x_1, y_1, y_2]$ the system (4.31)-(4.33) is rewritten in the general form (4.40) as:

$$f_c = \begin{bmatrix} -z_1 + z_2 \\ -z_1 - z_2 + z_3 \\ -2(4z_1z_2 - z_1^2 - z_2^2 - z_1z_3 - z_3 + z_1 + z_2) \end{bmatrix}, \quad g_c = \begin{bmatrix} 0 \\ 0 \\ 1 \end{bmatrix}$$

and the continuous-time control is,

$$u_c = 2(4z_1z_2 - z_1^2 - z_2^2 - z_1z_3 + z_1) - 3z_3 + z_2.$$

By using the design formulas for the sampled-data controller (4.44)-(4.46), then $u_d^{\delta^2} = u_{d0} + \delta/2u_{d1} + \delta^2/6u_{d2}$, with

$$u_{d0} = u_c|_{t=k\delta} \quad (4.51)$$

$$\begin{aligned} u_{d1} &= \dot{u}_c|_{t=k\delta} \\ &= 4z_{2k} - 3z_{1k} + 4z_{3k} - 14z_{1k}z_{2k} + 12z_{1k}z_{3k} - 6z_{2k}z_{3k} - 4z_{1k}^2 + 12z_{2k}^2 \end{aligned} \quad (4.52)$$

respectively u_{d2} which is computed from

$$u_{d2} = \ddot{u}_c|_{t=k\delta} + \frac{u_{d1}}{2} \frac{L_{f_c}L_{g_c}V_3 - L_{g_c}L_{f_c}V_3}{L_{g_c}V_3}|_{t=k\delta}$$

with $V_3 = (z_{1k}^2 + z_{2k}^2 + z_{3k}^2)/2$ is given by

$$\begin{aligned} u_{d2} &= 2z_{1k} - 17z_{2k} - 12z_{1k}z_{2k} - z_{3k}(48z_{1k} - 54z_{2k} - 6z_{1k}z_{2k} + 12z_{1k}^2 + 4) - 12z_{1k}z_{2k}^2 \\ &+ 14z_{1k}^2z_{2k} + 29z_{1k}^2 + 4z_{1k}^3 - 41z_{2k}^2 - 6z_{3k}^2 + \frac{z_{2k}}{2z_{3k}}(4z_{1k}^2 + 14z_{1k}z_{2k} + 3z_{1k} - 12z_{2k}^2 - 4z_{2k}) \end{aligned} \quad (4.53)$$

This controller assures the reproduction of $V_3(z_1, z_2, z_3)$ in the sense that the equality (4.43) holds with an error in $O(\delta^3)$.

In order to translate the controller expressions into initial variables next change of coordinates is required:

$$z_{1k} = x_{1k}, \quad z_{2k} = x_{2k} + x_{1k}^2, \quad z_{3k} = x_{3k} + 2(x_{1k} + x_{2k} + x_{1k}(x_{1k}^2 + x_{2k}) + x_{1k}^2)$$

4.4 SAMPLED-DATA MULTIRATE CONTROL FOR STRICT-FEEDBACK SYSTEMS

The multirate sampling technique has been proposed in the nonlinear context for preserving under sampling suitable structural stability properties of continuous-time dynamics [Monaco & Normand-Cyrot 2001]. A m order multirate sampling means, in the present context, that the control variables are sampled faster (e.g. m -times) than the data variables are measured. The control input $u(t)$ is thus assumed constant over intervals of amplitude $\bar{\delta} = \delta/m$ thus allowing m different control values on each sampling interval of length δ .

The main idea is that multiple changes of the control variables during the sampling period increase the degrees of freedom of the map which describes the sampled system. It is shown, for instance in [Monaco & Normand-Cyrot 2007], that the use of this technique provides the same performance as the use of high-order holders devices and generalized sampling.

4.4.1 Motivation

In order to motivate the need of this new approach let us analyze, in the following lines, the stabilizing properties of the strict-feedback systems when using single-rate sampled-data controllers.

According to the backstepping procedure, at a first step a virtual control $\xi = \phi(z)$ is designed such that it brings the z dynamics to a stable equilibrium. Then, a Lyapunov function $W(z)$ describes the stabilizing property of this first dynamics when the error dynamics y approaches to 0. For the second sub-system a controller is designed with a specific Lyapunov function $V(z, y) = W(z) + \frac{1}{2}y^2$. The question we posed is what happens with the evolution of W when sampling is considered? Is the reproduction of V a sufficient condition for ensuring the stability properties on the first dynamics?

In [Section 3.2](#) it was shown that the single-rate controller offers a reproduction of the continuous-time Lyapunov evolution of V under sampling with an error fixed by the approximation order of the controller. However regarding the W evolution, one gets

$$W(z_{k+1}) - W(z_k) \leq -\delta\rho_W(\|z_k\|) + O(\delta^3) \quad (4.54)$$

whatever is the order P of the approximated controller with ρ_W a \mathcal{K} function. This means that even by reducing error on the V reproduction, the stability can be affected by the resulting behaviour of W . If we look precisely to the terms of the V function then the same analysis can be performed as in [Section 2.4.1](#).

Let us suppose that there exist \mathcal{K} functions ρ_W, ρ_y so that the next inequalities holds, for a continuous-time controller u_c when considering an exact equivalent discrete-time system and the same initial conditions:

$$W(z_{k+1}^c) - W(z_k^c) \leq -\delta\rho_W(\|z_k^c\|) \quad (4.55)$$

$$\frac{1}{2}((y_{k+1}^c)^2 - (y_k^c)^2) \leq -\delta\rho_y(\|y_k^c\|) \quad (4.56)$$

By taking into account equation (4.5), the sampled-evolution of V , in the case of a single-rate controller of order P , can be bounded for each dynamic in the following manner

$$V(x_{k+1}) - V(x_k) = V(z_{k+1}, y_{k+1}) - V(z_k, y_k) \leq -\delta(\rho_W(\|z_k\|) + \rho_y(\|y_k\|)) + O_W(\delta^3) + O_y(\delta^3) \quad (4.57)$$

It is clear that the single-rate design imposes no performances for the internal dynamics of the system. The single-rate version concerns only the V evolution of the system. The idea that follows is to impose new matching conditions in order to reduce the contribution of remaining terms O_W and O_y . To do this the best solution is to consider a matching criteria on W together with requiring Lyapunov V matching. In this way the matching on y^2 is also ensured.

For this case the means of a multi-rate approach represents a good option.

Important remark

$$V(z_{k+1}, y_{k+1}) - V(z_k, y_k) \leq -\delta(\rho_W(|z_k|) + \rho_y(|y_k|)) + O_W(\delta^3) + O_y(\delta^3)$$

When imposing the input/Lyapunov matching on V this does not necessarily imply, also, the matching properties on W . Hence, when the Lyapunov difference $V(z_{k+1}, y_{k+1}) - V(z_k, y_k) < 0$ this does not guarantee that also $W(z_{k+1}) - W(z_k) < 0$ when y is small. As a consequence, a better solution should be provided by requiring an additional matching condition on W .

The idea performed below is to add more freedom degree on the control variable through multirate sampling. In this way extra conditions can be easily addressed.

4.4.2 Multirate sampling of 2nd order

Let us now return to the one cascade connection defined by (4.1)-(4.2). In this section, we use the same notations for x^T , f_c , g_c defined in the beginning of section 4.3. As this system has a relative degree 2, with respect to the output $y = x_1$, it comes naturally to propose a procedure involving a second order rate sampling with $\bar{\delta} = \delta/2$. In this context we consider two digital controllers that are piecewise continuous along the sampling interval $\bar{\delta}$ with these assumptions:

- A. u_{1k} is active and constant for $\forall t \in [k\bar{\delta}, k\bar{\delta} + \delta/2)$,
- B. u_{2k} is active and constant for $\forall t \in [k\bar{\delta} + \delta/2, (k+1)\bar{\delta})$.

The sampled-data dynamics equivalent of system (4.40) under the action of the control pair (u_{1k}, u_{2k}) is given by

$$x_{k+1} = F_d^{\bar{\delta}}(x_k, u_{1k}, u_{2k}) = e^{\text{BCH}^2\left(\frac{\bar{\delta}}{2}(f_c + u_{1k}g_c), \frac{\bar{\delta}}{2}(f_c + u_{2k}g_c)\right)} \quad (4.58)$$

where BCH^2 is the 2nd order Baker-Campbell Hausdorff exponent. This representation highlights the contribution of the two digital controllers to the states dynamics evolution.

Now, we have to find the expressions of u_{1k} and u_{2k} such that the stabilizing properties match the ones of the continuous-time plant. In this case, two objectives can be imposed by means of a multi-rate design.

By applying the ideas from the previous section, the first objective that should be imposed is already stated in [Theorem 40](#):

$$V(x_{k+1}) - V(x_k) = \int_{k\delta}^{(k+1)\delta} \dot{V}(x_c(\tau)) d\tau. \quad (4.59)$$

where x_{k+1} is computed from [\(4.58\)](#).

The second objective is given by the dynamic of the first sub-system [\(4.1\)](#) for which it is known, from the continuous-time setting, that there exists a Lyapunov function $W(z)$ which ensures the stability properties for this dynamics. Under sampling it is natural to consider also the matching of W . In the next lines we note $W(x)$ which has components only in $x_1 = z$. The second objective is written as:

$$W(x_{k+1}) - W(x_k) = \int_{k\delta}^{(k+1)\delta} \dot{W}(x_c(\tau)) d\tau \quad (4.60)$$

where x_{k+1} is computed from [\(4.58\)](#).

Now we can sum up these observations into the next theorem.

Theorem 42. *Consider a strict-feedback system of the form [\(4.1\)](#)-[\(4.2\)](#), and suppose the existence of a continuous-time controller u_c , computed from a backstepping procedure, such that the Lyapunov functions W and V exist, which guarantee the stability of the first sub-system and of the whole system, respectively. Then there exists a 2-rate feedback controller $u_{1k} = u_{1d}^{\bar{\delta}}$, $u_{2k} = u_{2d}^{\bar{\delta}}$ which ensures the matching of Lyapunov evolutions under sampling and guarantees the global asymptotic stability of the sampled-data equivalent system for a small enough sampling period.*

Proof. The proof of this theorem makes reference to [Theorem 40](#). As already shown in the proof of the previous theorem, the controller solution can be set as an asymptotic expansion in powers of δ . In this case, where $\bar{\delta} = \delta/2$, the controllers have these expressions:

$$u_{ik} = u_{id}^{\bar{\delta}} = u_{di0} + \sum_{j \geq 1} \frac{\delta^j}{2^j(j+1)!} u_{dij}, \quad i = 1, 2. \quad (4.61)$$

We construct a smooth map $Q : \mathcal{U} \rightarrow \mathbb{R}^2$, where \mathcal{U} is an open set of $\mathbb{R}^{n+m+1} \times \mathbb{R}^2$ as

$$Q(x_k, \delta, u_{1k}, u_{2k}) = \begin{bmatrix} \frac{1}{\delta} \left(e^{\text{BCH}^2\left(\frac{\bar{\delta}}{2}(f_c + u_{1k}g_c), \frac{\bar{\delta}}{2}(f_c + u_{2k}g_c)\right)} V(x) - e^{\delta(f_c(\cdot) + u_c(\cdot)g_c(\cdot))} V(x) \right) \\ \frac{1}{\bar{\delta}^2} \left(e^{\text{BCH}^2\left(\frac{\bar{\delta}}{2}(f_c + u_{1k}g_c), \frac{\bar{\delta}}{2}(f_c + u_{2k}g_c)\right)} W(x) - e^{\delta(f_c(\cdot) + u_c(\cdot)g_c(\cdot))} W(x) \right) \end{bmatrix} \quad (4.62)$$

Let us consider now (a, b) a point of the set \mathcal{U} with $a = (x_k, 0) \in \mathbb{R}^{n+m+1}$ and $b = (u_{d10}, u_{d20}) \in \mathbb{R}^2$.

By computing the Jacobian of Q one gets,

$$\left[\frac{\partial Q_i(\cdot)}{\partial u_{jk}} \Big|_{\{a,b\}} \right] = \begin{bmatrix} L_{g_c} V(x_k) & L_{g_c} V(x_k) \\ 3L_{g_c} L_{f_c} W(x_k) & L_{g_c} L_{f_c} W(x_k) \end{bmatrix} \quad (4.63)$$

which is nonsingular since by some computations it results that

$$L_{g_c} V(x_k) \cdot L_{g_c} L_{f_c} W(x_k) = x_2 b(x_1, x_2)^2 \frac{\partial W}{\partial x_1} g(x_1) \neq 0,$$

for all x_k . The last expression is non zero since the definition of strict feedback systems gives that $b(x_1, x_2)$, $g(x_1)$ are invertible for any $x_1, x_2 \neq 0$. If we translate into initial condition it means that the conditions holds if $z \neq$ and $\xi \neq \phi(z)$. The condition of the input-Lyapunov matching holds if $Q(x_k, \delta, u_{1k}, u_{2k}) = [0, 0]^T$. One verifies that for $\delta = 0$:

$$Q(x_k, 0, u_{1d0}, u_{2d0}) = \begin{bmatrix} (L_{f_c} + \frac{u_{1d0} + u_{2d0}}{2} L_{g_c}) V - (L_{f_c} + u_c(\cdot) L_{g_c}) V \\ (3u_{1d0} + u_{2d0}) L_{g_c} L_{f_c} W - 4u_c(\cdot) L_{g_c} L_{f_c} W \end{bmatrix}$$

The matching condition for $\delta = 0$ is accomplished by setting $u_{1d0} = u_{2d0} = u_c(x_k)$. Now we have all the ingredients to call the *implicit function Theorem* [Lee 2006, Th.7.9]. According to this, given the point (a, b) in the open set U , such that $Q(a, b) = 0$ where Q is a smooth application and its Jacobian is nonsingular, then there exists a map γ defined on the neighborhood U_a of a and U_b of b such that for all $x \in U_a$ and $y \in U_b$, $y = \gamma(x)$.

In this case, this means that for a small enough δ , there exists a pair of controllers (u_{1k}, u_{2k}) in the neighborhood of $b = (u_{d10}, u_{d20})$ which are given by a map $\gamma(x_k, \delta)$ i.e

$$(u_{1d}^\delta, u_{2d}^\delta) := \gamma(x_k, \delta) \quad (4.64)$$

such that

$$Q(x_k, \delta, \gamma(x_k, \delta)) = [0, 0]^T,$$

with

$$(u_{d10}, u_{d20}) = \gamma(x_k, 0).$$

As the Lyapunov matching conditions hold on V and W , the sampled-data system preserves the same stability properties at the sampling instants. \square

The first 2-rate terms of the controller are computed as:

$$(u_{d10}, u_{d20}) = (u_c|_{x_k}, u_c|_{x_k}) \quad (4.65)$$

$$(u_{d11}, u_{d21}) = \left(\frac{2}{3} \dot{u}_c \Big|_{x_k}, \frac{10}{3} \dot{u}_c \Big|_{x_k} \right) \quad (4.66)$$

$$\begin{aligned} u_{d12} &= \frac{4}{3} \dot{u}_c \left(4u_c L_{g_c}^2 L_{f_c} + L_{g_c} L_{f_c}^2 \right) W \cdot (L_{g_c} L_{f_c} W)^{-1} - 6\dot{u}_c u_c L_{g_c} V \cdot (L_{g_c} V)^{-1} \Big|_{x_k} \\ u_{d22} &= 8\dot{u}_c + 12\dot{u}_c u_c L_{g_c} V \cdot (L_{g_c} V)^{-1} - u_{d12} \Big|_{x_k}. \end{aligned} \quad (4.67)$$

Remark 43. It is interesting to note that the condition of computing the digital multi-rate controller (i.e. $L_{g_c} L_{f_c} W = \frac{\partial W}{\partial x_1} g(x_1) b(x_1, x_2) \neq 0, \forall x_k \neq 0$) is not a supplementary condition. This above condition is satisfied in the same time with the one imposed in the continuous-time backstepping design.

More details about computing these terms are given in the [Chapter 14](#).

This procedure improves the stability properties of the sampled-data system. This fact is enclosed in the following proposition.

Proposition 44. *Given the same conditions as in Proposition 35, the Lyapunov V difference of the sampled-data system with an P -order 2-rate controller computed as in Section 4.4.2 satisfies:*

$$V(z_{k+1}, y_{k+1}) - V(z_k, y_k) \leq -\delta(\rho_W(|z_k|) + \rho_y(|y_k|) + O_W(\delta^{P+2}) + O_y(\delta^{P+1})) \quad (4.68)$$

and also

$$V(z_{k+1}, y_{k+1}) - V(z_k, y_k) \leq -\delta\rho_V(|z_k|) + O_V(\delta^{P+1}) \quad (4.69)$$

Proof. The proof is immediate by computing the terms of $DV_{sc}(x_k)$ of (2.44) in the case of V , W and y evolutions. These computations give the Lyapunov functions dependencies in δ and then are replaced in the stabilizing conditions of the continuous-time controller (4.56). \square

The proposed approach, related to the single-rate version, is based on the same objective of input/Lyapunov matching and it requires in addition a 2-time faster controller. The single-rate approach is interested in the preservation of the whole Lyapunov stability V of the system, neglecting the behavior of W . By augmenting, in some sense, the number of the controllers in the multi-rate approach, we impose in addition the matching condition of W . In this case, better stability performance for the dynamics of the system is obtained.

4.4.3 Multirate sampling of m -th order

In this subsection we formulate the control solution for a more general case - the m cascade connections. Let us consider the more general system given by the equations (4.29) with the $m + 1$ Lyapunov functions as defined by (4.30). Further we consider the same compact form (4.40), with the functions defined in subsection 4.3.3. For this case, it becomes natural to choose a control solution involving the $m + 1$ rates. We will denote by $\bar{\delta} = \frac{\delta}{m+1}$ the controller period used. Then the $m + 1$ controllers are defined thus,

1. u_{ik} is active and constant for $\forall t \in [k\delta + (i-1)\bar{\delta}, k\delta + i\bar{\delta})$, where $1 \leq i \leq m+1$.

The sampled-data dynamics equivalent of the system (4.40) under the action of the $m + 1$ controllers is given by

$$x_{k+1} = F^{\delta}(x_k, u_{1k}, u_{2k}, \dots, u_{m+1k}) = e^{\text{BCH}^{m+1}(\bar{\delta}(f_c + u_{1k}g_c), \bar{\delta}(f_c + u_{2k}g_c), \dots, \bar{\delta}(f_c + u_{m+1k}g_c))} \quad (4.70)$$

where BCH^{m+1} is the $m + 1$ order Baker-Campbell Hausdorff exponent.

In a similar way, we have to find the expressions of the controllers in order to match the stabilizing properties with the ones of the continuous-time plant. In this case we should impose the $m + 1$ objectives (we have defined the $m + 1$ Lyapunov functions).

The next theorem gives the multi-rate control solution for the general case.

Theorem 45. Consider a strict-feedback form (4.29) with $m + 1$ sub-systems, and suppose the existence of the continuous-time controller u_c , computed from a backstepping procedure, such that the Lyapunov functions W, V_1, \dots, V_m exist, each guaranteeing the stability of the first connections. Then there exists an $m + 1$ -rate feedback controller $u_{ik} = u_{id}^{\bar{\delta}}$ which ensures the same Lyapunov evolutions under sampling and guarantees the global asymptotic stability of the sampled-data equivalent system for a small enough sampling period.

Proof. The proof of this theorem is very similar with the one provided for Theorem 42. We will give only some elements of the proof. The controllers solution for this case, where $\bar{\delta} = \delta/(m + 1)$ should be chosen as:

$$u_{ik} = u_{id}^{\bar{\delta}} = u_{di0} + \sum_{j \geq 1} \frac{\delta^j}{(m+1)^j(j+1)!} u_{dij}, \quad i = 1, 2, \dots, m+1 \quad (4.71)$$

with $i = 1, 2, \dots, m+1$.

The map $Q : U \rightarrow \mathbb{R}^{m+1}$, where U is an open set of $\mathbb{R}^{n+m+1} \times \mathbb{R}^{m+1}$ should be defined as:

$$Q(x_k, \delta, u_{1k}, u_{2k}, \dots, u_{m+1k}) = \begin{bmatrix} \frac{1}{\delta} \left(e^{\text{BCH}^{m+1}(\bar{\delta}(f_c + u_{1k}g_c), \bar{\delta}(f_c + u_{2k}g_c), \dots, \bar{\delta}(f_c + u_{m+1k}g_c))} V_{m+1}(x) - e^{\delta(f_c(\cdot) + u_c(\cdot)g_c(\cdot))} V_{m+1}(x) \right) \\ \frac{1}{\delta^2} \left(e^{\text{BCH}^{m+1}(\bar{\delta}(f_c + u_{1k}g_c), \bar{\delta}(f_c + u_{2k}g_c), \dots, \bar{\delta}(f_c + u_{m+1k}g_c))} V_m(x) - e^{\delta(f_c(\cdot) + u_c(\cdot)g_c(\cdot))} V_m(x) \right) \\ \vdots \\ \frac{1}{\delta^{m+1}} \left(e^{\text{BCH}^{m+1}(\bar{\delta}(f_c + u_{1k}g_c), \bar{\delta}(f_c + u_{2k}g_c), \dots, \bar{\delta}(f_c + u_{m+1k}g_c))} W(x) - e^{\delta(f_c(\cdot) + u_c(\cdot)g_c(\cdot))} W(x) \right) \end{bmatrix}$$

By computing the Jacobian of Q for $\delta = 0$ and $u_{ik} = u_{di0}$, for $i = 1, m+1$ then one gets the following:

$$\left[\frac{\partial Q_i(\cdot)}{\partial u_{jk}} \Big|_{\delta=0; u_{jk}=u_{jd0}} \right] = [\Gamma_{ij}] \begin{bmatrix} L_{g_c} V_m(x_k) & 0 & \dots & 0 \\ 0 & L_{g_c} L_{f_c} V_{m-1}(x_k) & \dots & 0 \\ \vdots & \vdots & \ddots & 0 \\ 0 & 0 & \dots & L_{g_c} L_{f_c}^m W(x_k) \end{bmatrix} \quad (4.72)$$

where the elements of the matrix Γ are defined as

$$\Gamma_{ij} = j^i - (j-1)^i \quad (4.73)$$

The above matrix multiplication is nonsingular since $\det(\Gamma) = (m+1)!$ and the product is

$$\prod_{i=0}^m L_{g_c} L_{f_c}^i W(x_k) \neq 0, \forall x_k \neq 0.$$

The condition of the input-Lyapunov matching holds if $Q(x_k, \delta, u_{1k}, u_{2k}, \dots, u_{m+1k}) = \underbrace{[0, \dots, 0]^T}_{\times m+1}$.

One verifies that for $\delta = 0$:

$$Q(x_k, 0, u_{1d0}, u_{2d0}, \dots, u_{m+1d0}) = \begin{bmatrix} (\sum_{i=0}^m u_{m+1-i d0} - (m+1)u_c(\cdot))L_{g_c} V_m \\ \vdots \\ (\sum_{i=0}^m \sum_{j=1}^{m+1} \Gamma_{ij} u_{m+1-i d0} - (m+1)^{m+1} u_c(\cdot))L_{g_c} L_{f_c}^m W \end{bmatrix}$$

It follows that the matching condition for $\delta = 0$ is accomplished if $u_{id0} = u_c(x_k)$ for all $i = 1, \dots, m+1$.

Now we have all the ingredients to call the *implicit function Theorem* [Lee 2006, Th.7.9] and to prove the existence of such controller. \square

4.4.3.1 Approximated controller

This design strategy imposes to each controller the preservation of the stability properties of each sub-system. For larger m it is clear that this method becomes difficult to implement practically.

It is interesting to remark that, for example, the first order approximated multi-rate controller ensures the reproduction of the Lyapunov function V_m with an error in $O(\delta^3)$ and for the W function the error is m times smaller e.g. $O(\delta^{m+2})$. The exact computation of the first terms of an approximated m -rate controller involves inverting a Vandermonde type matrix. In the next lines we will give some ingredients to compute the first order controller approximation in the case of m -rates.

By solving equality

$$Q(x_k, \delta, u_{1k}, u_{2k}, \dots, u_{m+1k}) = \underbrace{[0, \dots, 0]^T}_{m+1}$$

for a first order approximated controller ($P = 1$), then this can be written in the form:

$$[\Gamma_{ij}] \begin{bmatrix} u_{m+1 d1} \\ \vdots \\ u_{1 d1} \end{bmatrix} = \begin{bmatrix} \frac{(m+1)^2}{2} \\ \vdots \\ \frac{(m+1)^{m+2}}{m+2} \end{bmatrix} 2\dot{u}_c(x_k) \quad (4.74)$$

where the controller terms u_{id1} can be computed by solving the linear system. A general solution can be computed if the inverse Γ^{-1} can be computed explicitly. It must be pointed out that when m increases the conditioning number of the matrix Γ increases faster and the numerical computation errors of its inverse become more significant.

Let us exemplify the solution for $m = 3$ and $m = 4$.

$$(u_{1d1}, u_{2d1}, u_{3d1}) = \left(\frac{3}{4} \dot{u}_c \Big|_{x_k}, 3 \dot{u}_c \Big|_{x_k}, \frac{21}{4} \dot{u}_c \Big|_{x_k} \right) \quad (4.75)$$

$$(u_{1d1}, u_{2d1}, u_{3d1}, u_{4d1}) = \left(\frac{332}{45} \dot{u}_c \Big|_{x_k}, \frac{68}{15} \dot{u}_c \Big|_{x_k}, \frac{52}{15} \dot{u}_c \Big|_{x_k}, \frac{28}{45} \dot{u}_c \Big|_{x_k} \right) \quad (4.76)$$

These expressions are well defined since, by construction $L_{g_c} L_{f_c}^i V_{m-i} \neq 0, \forall x_k \neq 0$.

Proposition 46. *The approximated m -rate controller of P order $u_d^{\delta^P}$ asymptotically stabilizes the system with m cascade connections with an error on V_m matching $O(\delta^{P+1})$ respective with an error on W matching of $O(\delta^{P+m+1})$*

Proof. After some computations, the multi-rate controller of P order gives the following

$$\begin{aligned} & V_m(z_{k+1}, y_{1k+1}, \dots, y_{mk+1}) - V_m(z_k, y_{1k}, \dots, y_{mk}) \\ & \leq -\delta(\rho_W(|z_k|) + \rho_{y_1}(|y_{1k}|) + \dots + \rho_{y_m}(|y_{mk}|)) + O_W(\delta^{P+m+1}) + O_{y_1}(\delta^{P+m}) + \dots + O_{y_m}(\delta^{P+1}) \end{aligned}$$

respective

$$V_m(x_{k+1}) - V_m(x_k) \leq -\delta \rho_{V_m}(\|x_k\|) + O_{V_m}(\delta^{P+1}) \quad (4.77)$$

where $\rho_W, \rho_{y_i}, \rho_{V_m}$ are \mathcal{K} functions defined for the continuous-time case. \square

This means that the multi-rate controller will maintain the stabilization properties of the internal dynamics. The first dynamic z , which in many practical situations has the major interest, is favored by this design. The multi-rate approach can be used with great success in the case of systems with a chain of integrators in the control inputs path, when the emulated solutions fail to work even for lower sampling periods.

4.5 SIMULATION RESULTS

In this section, there are provided simulation results for the same model used in [Section 4.2.1](#) and [4.3.2](#). Let us recall the main results, expressed into the initial system coordinates. Given the system with one integrator in the inputs path:

$$\dot{x}_1(t) = x_1^2(t) + x_2(t) \quad (4.78)$$

$$\dot{x}_2(t) = u \quad (4.79)$$

with an initial Lyapunov function $W(x_1) = x_1^2/2$. The continuous-time controller based on the backstepping design,

$$u_c = -(K_\phi + K_y)(x_1^2 + x_2) - 2x_1^3 - (2x_2 + K_\phi K_y + 1)x_1; \quad (4.80)$$

with the gains parameters $K_\phi > 0$ and $K_y > 0$ and a global Lyapunov function V , constructed as,

$$V(x_1, x_2) = \frac{1}{2}(x_1^2 + (K_\phi x_1 + x_2 + x_1^2)^2). \quad (4.81)$$

SINGLE-RATE DESIGN The single-rate backstepping controller (BksSR) of the second order approximation is computed as :

$$u_d^{\delta 2} = u_{d0} + \frac{\delta u_{d1}}{2!} + \frac{\delta^2}{3!} u_{d2} \quad (4.82)$$

with the following terms expression:

$$u_{d0} = u_c|_{t=k\delta} \quad (4.83)$$

$$\begin{aligned} u_{d1} = & K_\phi^2 x_2 - x_2 + K_y^2 x_2 + x_1^2 (K_\phi^2 + 3K_\phi K_y + K_y^2 - 4x_2 + 1) \\ & + x_1 (K_\phi + K_y + 2K_\phi x_2 + 2K_y x_2 + K_\phi K_y^2 + K_\phi^2 K_y) - 2x_1^4 - 2x_2^2 + x_1^3 (2K_\phi + 2K_y) + K_\phi K_y x_2 \end{aligned} \quad (4.84)$$

$$\begin{aligned} u_{d2} = & (3x_1)/2 + (5K_\phi x_2)/2 + 2K_y x_2 + 10x_1 x_2 - x_1^3/(x_1^2 + K_\phi x_1 + x_2) - (7K_\phi x_1^2)/2 - 2K_\phi^2 x_1 \\ & + 5K_\phi x_1^4 + 7K_\phi x_2^2 - 2K_y x_1^2 - (3K_y^2 x_1)/2 - (3K_\phi^3 x_2)/2 + 4K_y x_1^4 + 6K_y x_2^2 - K_y^3 x_2 + 2x_1 x_2^2 \\ & + 4x_1^3 x_2 + 8x_1^5 + 2x_1^5 - 4K_\phi^2 x_1^3 - (3K_\phi^3 x_1^2)/2 - 3K_y^2 x_1^3 - K_y^3 x_1^2 + (2K_\phi^2 x_1^3)/(x_1^2 + K_\phi x_1 + x_2) \\ & + (K_\phi^3 x_1^2)/(2(x_1^2 + K_\phi x_1 + x_2)) - (9K_\phi K_y^2 x_1^2)/2 - (11K_\phi^2 K_y x_1^2)/2 - (3K_\phi^2 K_y^2 x_1)/2 \\ & - K_\phi K_y x_1 - (K_\phi x_1^2)/(x_1^2 + K_\phi x_1 + x_2) - (K_y x_1^2)/(2(x_1^2 + K_\phi x_1 + x_2)) - K_\phi K_y^3 x_1 \\ & - (3K_\phi^3 K_y x_1)/2 - (3K_\phi K_y^2 x_2)/2 - (3K_\phi^2 K_y x_2)/2 + 12K_\phi x_1^2 x_2 - 4K_\phi^2 x_1 x_2 + 10K_y x_1^2 x_2 \\ & - 3K_y^2 x_1 x_2 + 2K_\phi K_y x_1 x_2 \end{aligned} \quad (4.86)$$

TWO-RATE DESIGN The second approach, involving 2-rate sampling (BksMR), consists of two digital controller of the second order approximations defined as follows:

$$u_{di}^{\delta 2} = u_{di0} + \frac{\delta}{4} u_{di1} + \frac{\delta^2}{24} u_{di2}, \quad i = 1, 2 \quad (4.87)$$

under the assumption that $u_{d1}^{\delta 2}$ is constant and active on the intervals $[k\delta, (k + \frac{1}{2})\delta)$, respective $u_{d2}^{\delta 2}$ is constant and active on the intervals $[(k + \frac{1}{2})\delta, (k + 1)\delta)$. The controllers terms are given below:

$$(u_{d10}, u_{d20}) = (u_c|_{t=k\delta}, u_c|_{t=k\delta}) \quad (4.88)$$

$$\begin{aligned} u_{d11} = & 2(K_\phi^2 K_y x_1 + K_\phi^2 x_1^2 + K_\phi^2 x_2 + K_\phi K_y^2 x_1 + 3K_\phi K_y x_1^2 + K_\phi K_y x_2 + 2K_\phi x_1^3 + 2K_\phi x_1 x_2 \\ & + K_\phi x_1 + K_y^2 x_1^2 + K_y^2 x_2 + 2K_y x_1^3 + 2K_y x_1 x_2 + K_y x_1 - 2x_1^4 - 4x_1^2 x_2 + x_1^2 \\ & - 2x_2^2 - x_2)/3 \end{aligned} \quad (4.89)$$

$$\begin{aligned} u_{d12} = & 10(K_\phi^2 K_y x_1 + K_\phi^2 x_1^2 + K_\phi^2 x_2 + K_\phi K_y^2 x_1 + 3K_\phi K_y x_1^2 + K_\phi K_y x_2 + 2K_\phi x_1^3 + 2K_\phi x_1 x_2 \\ & + K_\phi x_1 + K_y^2 x_1^2 + K_y^2 x_2 + 2K_y x_1^3 + 2K_y x_1 x_2 + K_y x_1 - 2x_1^4 - 4x_1^2 x_2 + x_1^2 \\ & - 2x_2^2 - x_2)/3 \end{aligned} \quad (4.90)$$

$$u_{d21} = 0 \quad (4.91)$$

$$\begin{aligned} u_{d22} = & (-8)(K_\phi^3 K_y x_1 + K_\phi^3 x_1^2 + K_\phi^3 x_2 + K_\phi^2 K_y^2 x_1 + 3K_\phi^2 K_y x_1^2 + K_\phi^2 K_y x_2 + 2K_\phi^2 x_1^3 + 2K_\phi^2 x_1 x_2 \\ & + K_\phi^2 x_1 + K_\phi K_y^3 x_1 + 3K_\phi K_y^2 x_1^2 + K_\phi K_y^2 x_2 - 4K_\phi K_y x_1^3 - 4K_\phi K_y x_1 x_2 \\ & - 6K_\phi x_1^4 - 12K_\phi x_1^2 x_2 - 6K_\phi x_2^2 - 2K_\phi x_2 + K_y^3 x_1^2 + K_y^3 x_2 + 2K_y^2 x_1^3 + 2K_y^2 x_1 x_2 + K_y^2 x_1 \\ & - 6K_y x_1^4 - 12K_y x_1^2 x_2 - 6K_y x_2^2 - 2K_y x_2 - 8x_1^3 - 8x_1 x_2 - x_1). \end{aligned} \quad (4.92)$$

SIMULATIONS The parameters for the following simulations are given in [Table 4.1](#).

sampling period	initial conditions	gain	simulation time length	Figure labels
$\delta = 0.4$ s	$x_0 = [0.5 \ 0.5]$	$K_\phi = 1, K_y = 1$	$t_f = 10$ s	Figures 4.2 , 4.3 , 4.4
$\delta \in [0.01, \dots, 1]$ s	$x_0 = [0.5 \ 0.5]$	$K_\phi = 1, K_y = 1$	$t_f = 10$ s	Figure 4.5
$\delta \in [0.01, \dots, 0.3]$ s	$x_0 = [0.5 \ 0.5]$	$K_\phi = K_y =$ $K \in [0.1, \dots, 10]$	$t_f = 10$ s	Figure 4.6

Table 4.1: Numerical values of the simulation parameters- Example 3 -single and two-rates controllers

The controllers tested are: the continuous-time version (continuous line, "cont"), the emulated control(circle, "emul"), the single rate version of order 1 (triangle, "BksSR1") and of the 2nd order respectively (plus, "BksSR2"), the 2-rate version of order 1 (star, "BksMR1") and of the 2nd order respectively (square, "BksMR2"). In the Figures [4.2-4.4](#) are given the time evolutions of different variables: state, control, Lyapunov functions, trajectories. An easy comparison can be made with the continuous-time

evolution which is the “ethalon”. It is clear that the multi-rate version of digital controllers are performing best.

In order to evaluate these new approaches in a larger context, to see in which conditions depending on the sampling period and of the controller gains, each controller is performing best. The error criterion, which is defined in [Section 5.2.4](#), is here used to evaluate the performance of the each approach with respect to the objective of input/Lyapunov matching. This criterion was applied both on the evolution of W and V Lyapunov function. In [Figure 4.5](#) are plotted the Lyapunov error difference when $K_\phi = K_y = 1$ and the sampling period is in the range $[0.01, 1]$ seconds. The conclusions are the same with the ones obtained for the previous simulations, that the multi-rate version is performing better and also the second-order controller is superior to the first-order controller.

In [Figure 4.6](#) it was considered also a variations of the gains such that $K = K_\phi = K_y$ with $K = [0.1, 10]$. The sampling period has been restricted to the range $[0.01, 0.3]$. The errors level have been restricted to a maximum value equals to 1, for which it is considered that the stabilizing performance is acceptable. The red colored regions indicate the areas where the controlled system becomes unstable. These results confirm a known fact, when increasing the gain of a controller this lead to a decrease of the maximum sampling period. Consequently slowest controllers permit larger values for the sampling period. The strategy proposed, compared to the results obtained for the emulated control, extends both the use of admissible sampling periods and gains. These simulations represent a suitable tool to obtain estimations about the maximum sampling period that can be used in sampled-data schemes. The best results are obtained for the second order two-rate controller. The single-rate first order controller does not offer improvements related to the expansions of the use of the gains or δ but offers lower level errors for certain regions.

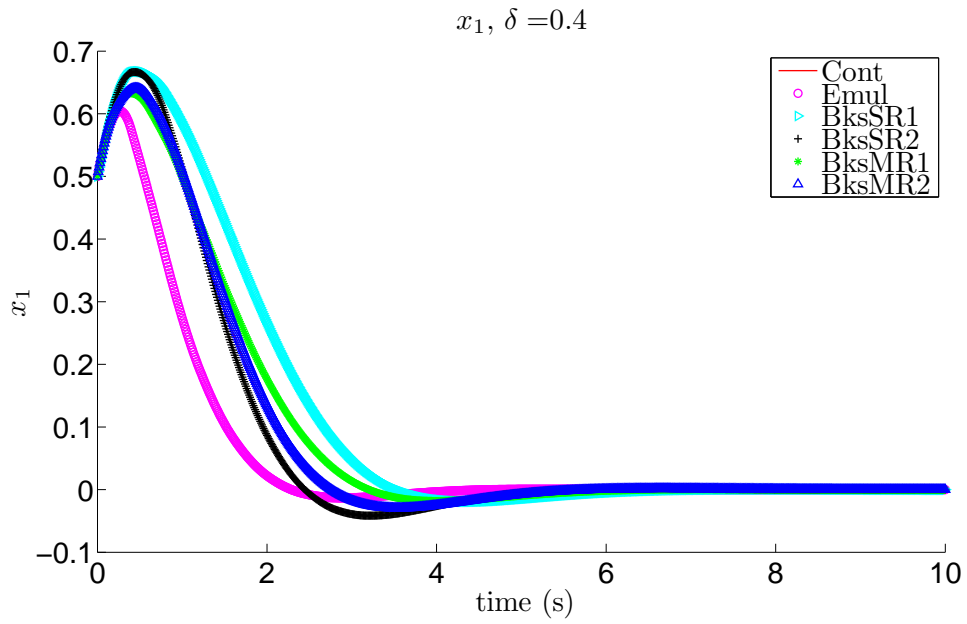

(a) State x_1 evolution

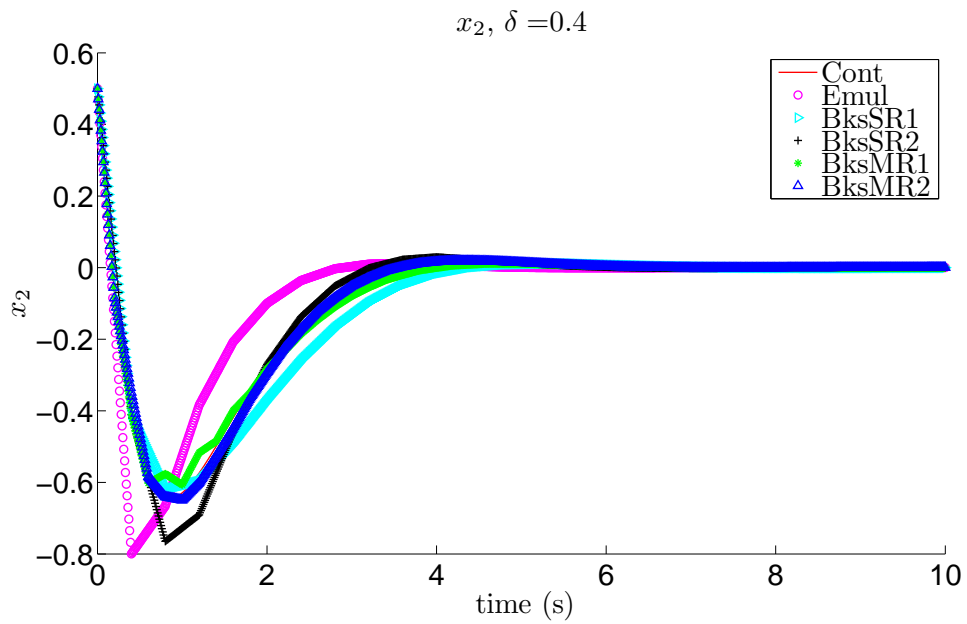

(b) State x_2 evolution

Figure 4.2: States evolutions for proposed algorithms, $\delta = 0.4s$

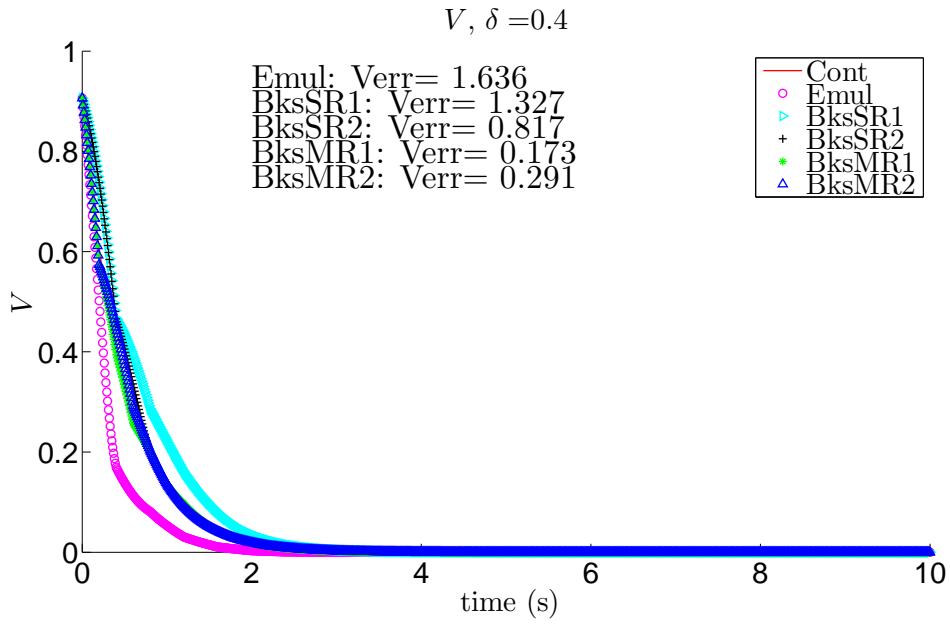

(a) Lyapunov V evolution

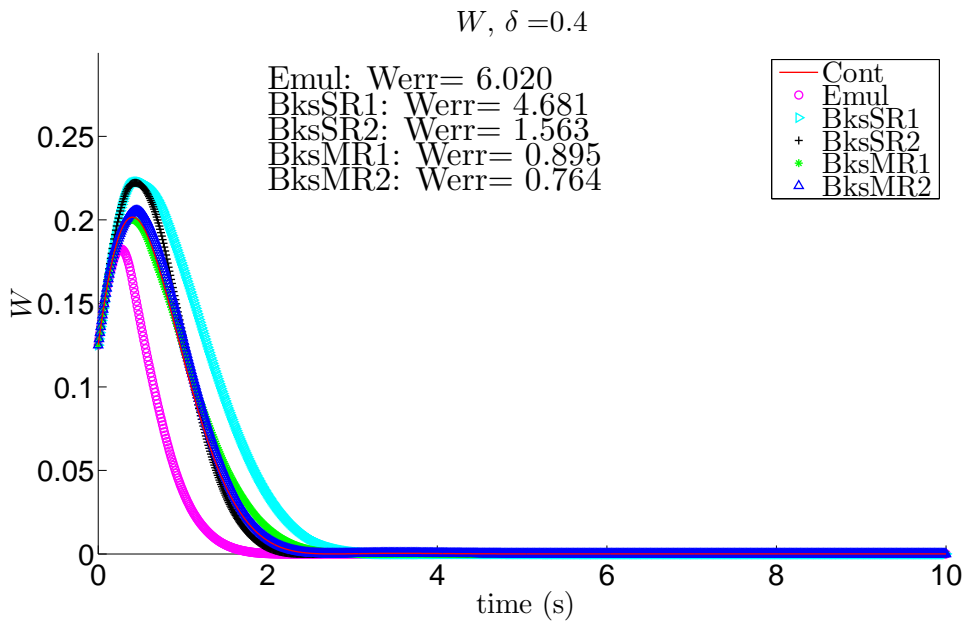

(b) Lyapunov W evolution

Figure 4.3: Lyapunov evolutions for proposed algorithms, $\delta = 0.4s$

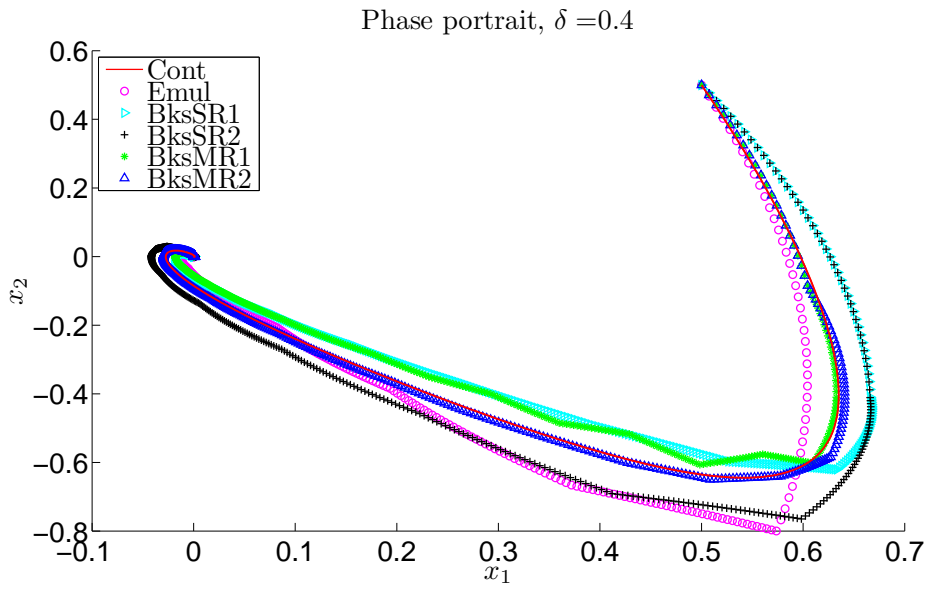

(a) Trajectories

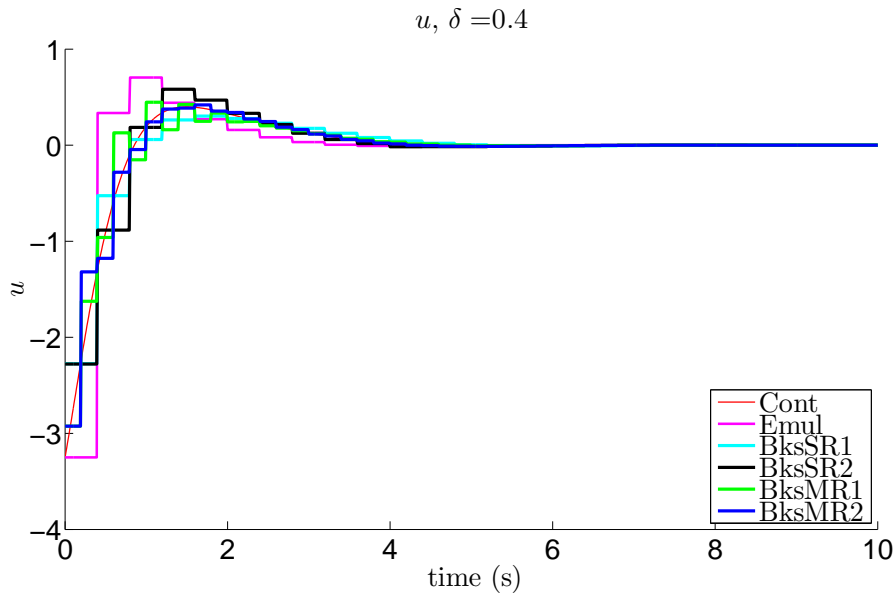

(b) Control evolution

Figure 4.4: Simulation results for the proposed algorithms, $\delta = 0.4s$

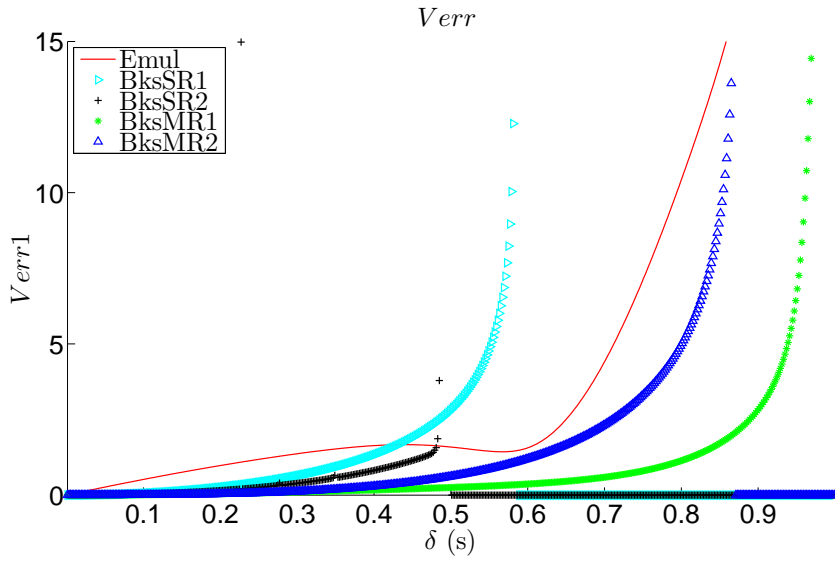

(a) Lyapunov V error matching

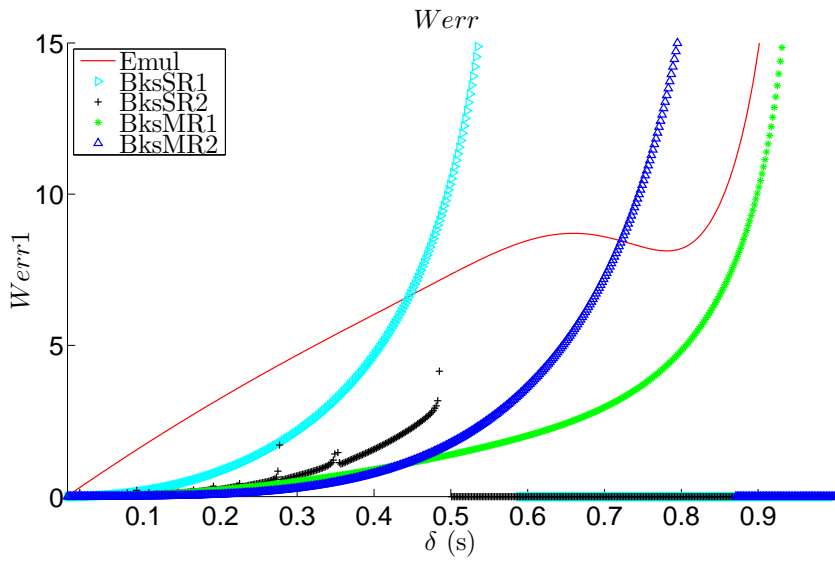

(b) Lyapunov W error matching

Figure 4.5: Lyapunov error matching results for the proposed algorithms

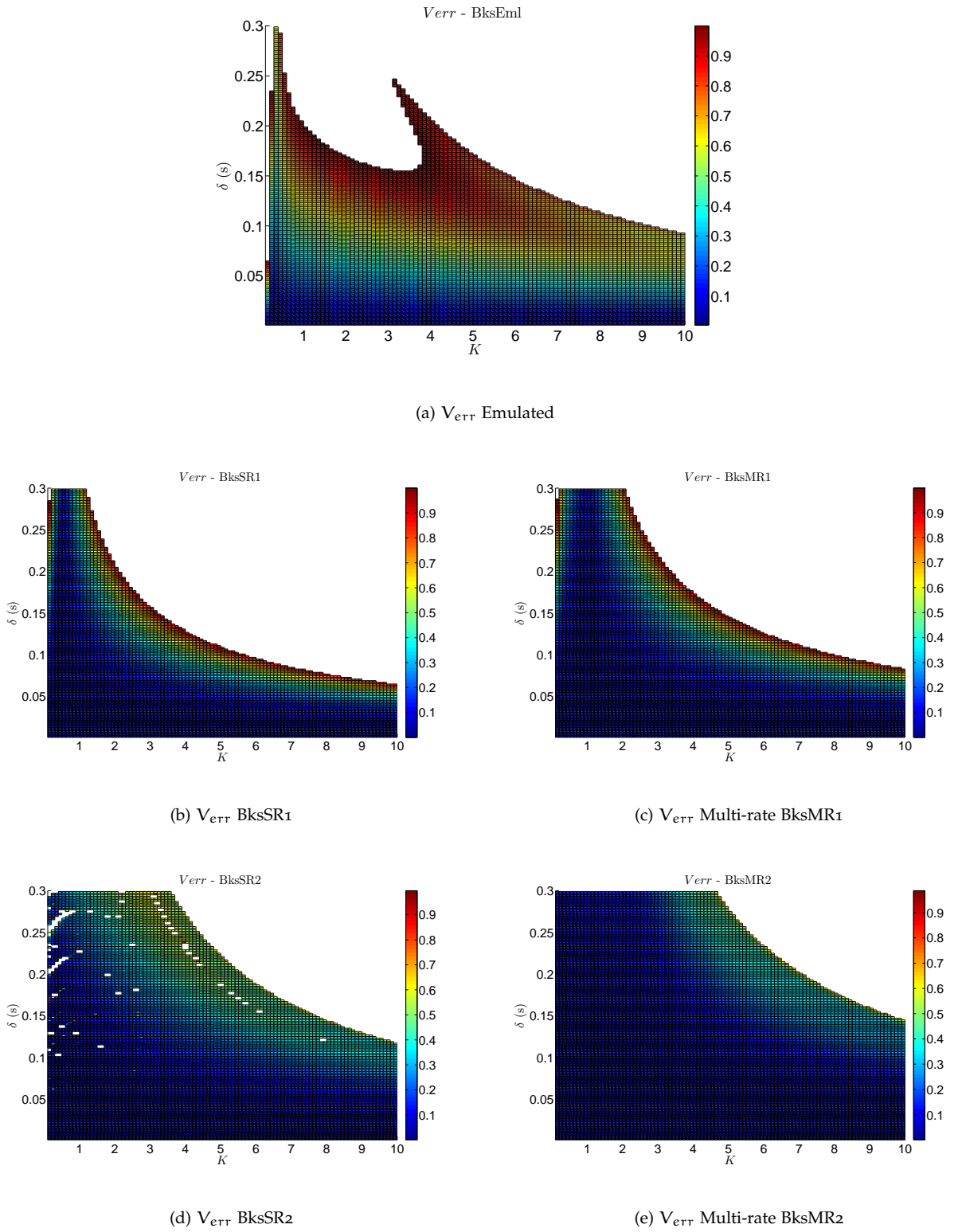

Figure 4.6: Lyapunov difference

Concluding remark

The results show, compared to the emulated version, that the proposed approaches maintain the continuous-time performance under sampling. The error criteria, in terms of Lyapunov matching, indicate that the best versions are the two-rate of the first and the second order controller approximations. The single-rate version of the second order is more sensitive to numerical errors due to the fact this solution is more complex. The simulations confirms also that the multi-rate version ameliorates the stability of the first dynamics, and consequently of the entire system. In view of these observations, the 2-rate controller should be chosen, because its simplicity and higher stability performance.

4.5.1 *Some comments with respect to other similar strategies*

It is useful to compare this new approach with those methodologies that claim appropriate results. We are referring here to that results obtained in the same context of digital redesign of the continuous-time controller.

In the article of [Nešić & Teel 2006] a digital design based on the Euler approximate discrete-time model of the plant is proposed. The results obtained assure semiglobal-practical stability of the exact model. The main difference of the design proposed in [Nešić & Teel 2006] and ours is that the controller is build from an approximate discrete-time model and not from an exact sampled-model as we have done here. Consequently our solutions performs better, in terms of stability properties as it is pointed out by the simulations results from the next section. Another aspect is that our approach applies to any nonlinear dynamics of the vector fields.

In the paper of [Nešić & Grüne 2005], two solutions for sampled-data implementations based on the redesign of the Lyapunov-based continuous-time controller are given. The first solution provides more negativity to the Lyapunov difference than the emulated control. The second solution tries to minimize the mismatches between the continuous and the sampled-data Lyapunov evolutions for a given order of the difference approximations. The specificity of our approach is that we try to match exactly these Lyapunov evolutions and not only “minimizing”. However, the first order term of the approximated controller is computed in the same manner in both approaches.

Another work of [Burlion *et al.* 2006], which relies on the works of Nešić and others [Nešić & Teel 2001],[Nešić & Grüne 2005], claims the same exact matching of the Lyapunov difference.

The design procedure presented there, is complicated and it is developed considering only the simplest version of the strict feedback systems. No generalization and comments about how the solution can achieve global stabilization are given. The methodology used in designing the controller expressions is confusing and does not match with our solutions (see the simulated example).

All these solutions are expected to perform better for larger sampling periods, compared with the emulated case. As it is highlighted by the next simulations, the increased order of a controller contains more complex expressions and as consequence more instability is expected for larger δ . This is a reason why, the first order approximated solutions are working better for larger sampling periods rather than the higher order approximated controllers.

In conclusion we mention that the proposed methodologies perform best with respect to other similar methodologies, in the context of the exact matching of the Lyapunov evolution under sampling.

4.5.1.1 Comparative simulations

To highlight the performance of the novel approaches related to other similar designs, we use the model from Example 3, (4.78)-(4.79) which is the same with the one used in [Nešić & Teel 2006], [Burlion *et al.* 2006] or [Nešić & Teel 2001].

The simulation parameters are given in Table 4.2. In the next figures there are plotted the evolutions of the Lyapunov functions, of the controllers and of the state variables x_1, x_2 . The controller expressions used in these simulations are indicated in the mentioned papers.

sampling period	initial conditions	simulation time length	Figure labels
$\delta = 0.4$ s	$x_0 = [0.5 \ 0.5]$	$t_f = 10$ s	Figures 4.7, 4.8, 4.9
$\delta \in [0.01, \dots, 1]$ s	$x_0 = [0.5 \ 0.5]$	$t_f = 10$ s	Figure 4.10
$\delta = 0.9$ s	$x_0 = [0.5 \ 0.5]$	$t_f = 10$ s	Figures 4.11, 4.12

Table 4.2: Numerical values of the simulation parameters- Example 3 -comparative study

In Figure 4.9, there are plotted the results for the following controllers: the continuous-time version (continuous line, “cont”), the single-rate of the second order (circle, “BksSR2”), the first order controller provided in [Nešić & Teel 2006] (triangle, “BksNe1”), the second order controller provided in [Nešić & Grüne 2005] (plus, “BksNe2”), the first order controller provided in [Burlion *et al.* 2006] (star, “BksBu1”) and the second order controller from [Burlion *et al.* 2006] (upper triangle, “BksBuz”).

As mentioned before, the first order controller proposed in [Nešić & Grüne 2005] coincides with the proposed approach “BksSR₁”.

In Figure 4.10 there are also given the results of the Lyapunov matching error for different sampling periods. These results are compared with the our strategies as are illustrated in Figure 4.5.

One can conclude that, based on the objective of the Lyapunov matching, the proposed strategies are superior to the ones provided in the literature. In terms of the V and W Lyapunov functions, the multi-rate controllers perform best. These approaches extend the use of higher sampling periods compared with the emulated case. The second order solutions, in this example, are more sensitive when increasing the sampling period. The simulations from Figures 4.11-4.12 are provided for $\delta = 0.9$ seconds, where the controllers which still manage to stabilize the system are of first order. The controller proposed in [Nešić & Teel 2006], has in this case the worst evolution.

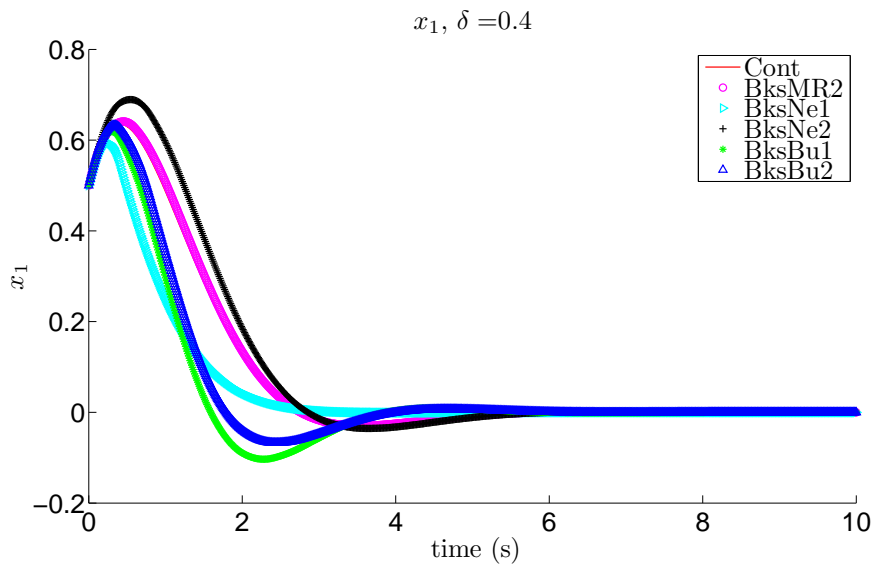

(a) State x_1 evolution

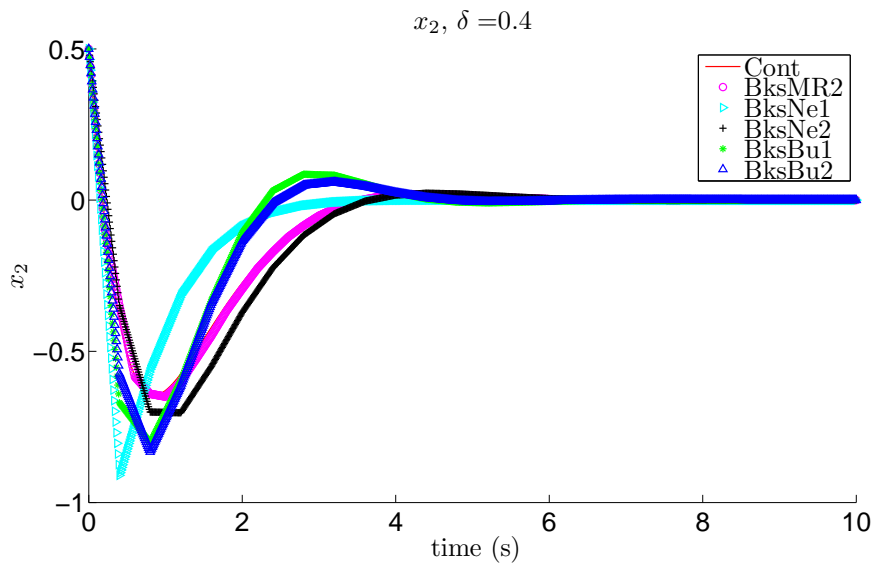

(b) State x_2 evolution

Figure 4.7: States evolutions for the compared algorithms, $\delta = 0.4s$

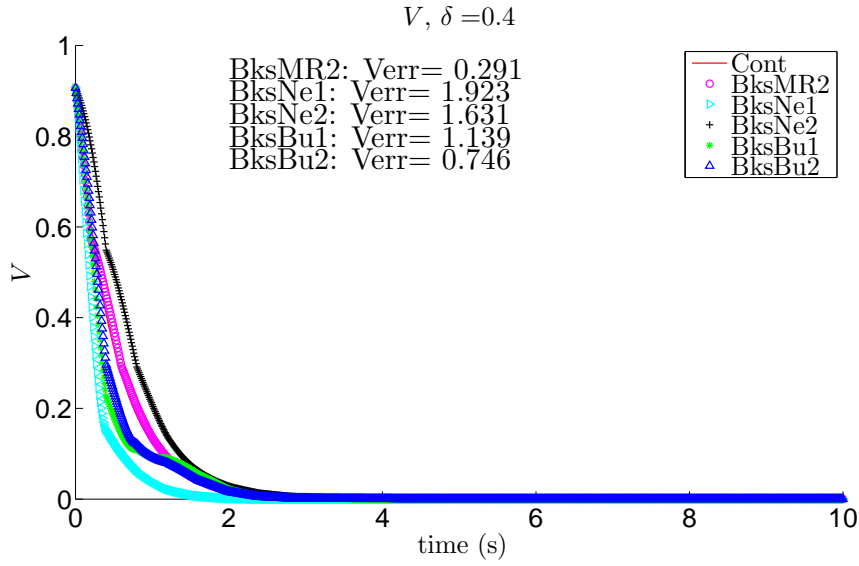

(a) Lyapunov V evolution

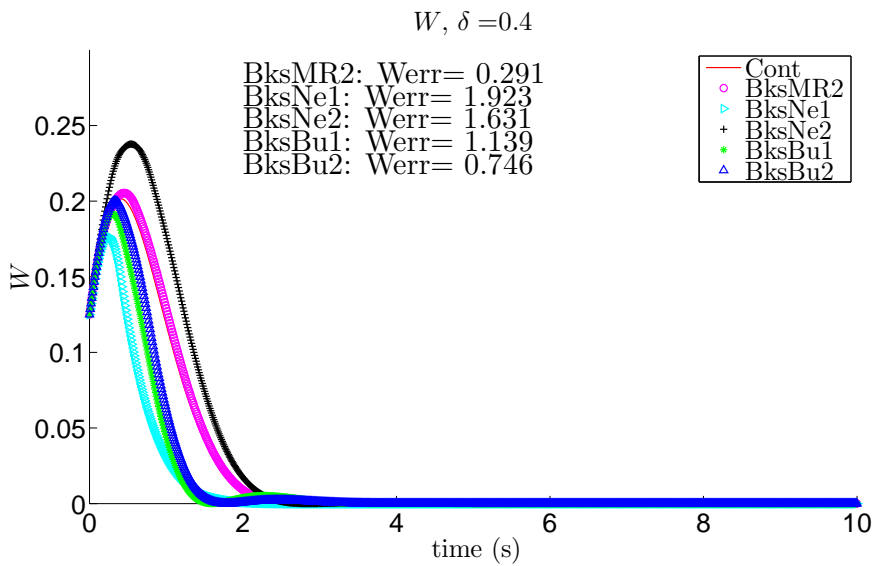

(b) Lyapunov W evolution

Figure 4.8: Lyapunov evolutions for compared algorithms, $\delta = 0.4s$

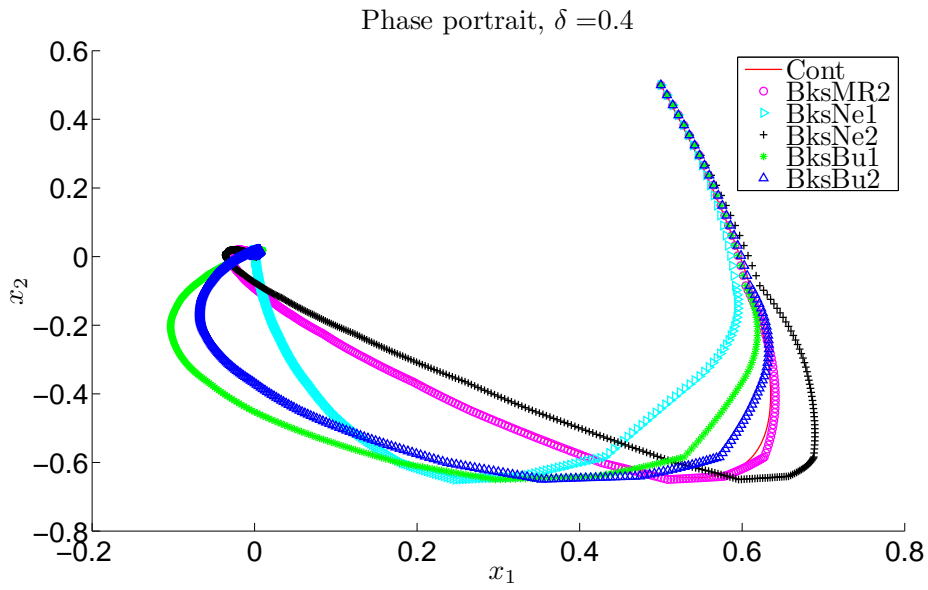

(a) Trajectories

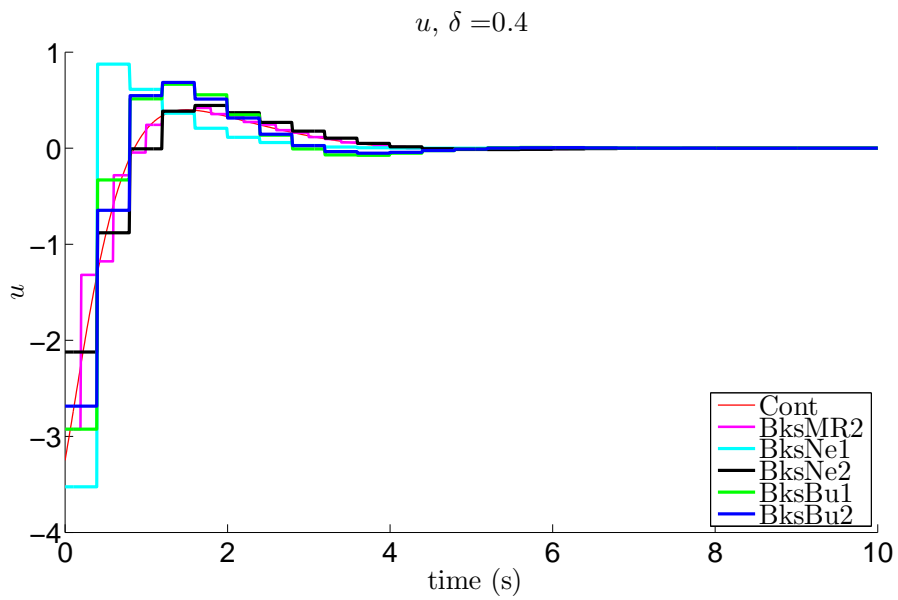

(b) Control evolution

Figure 4.9: Simulation results for the compared algorithms, $\delta = 0.4\text{ms}$

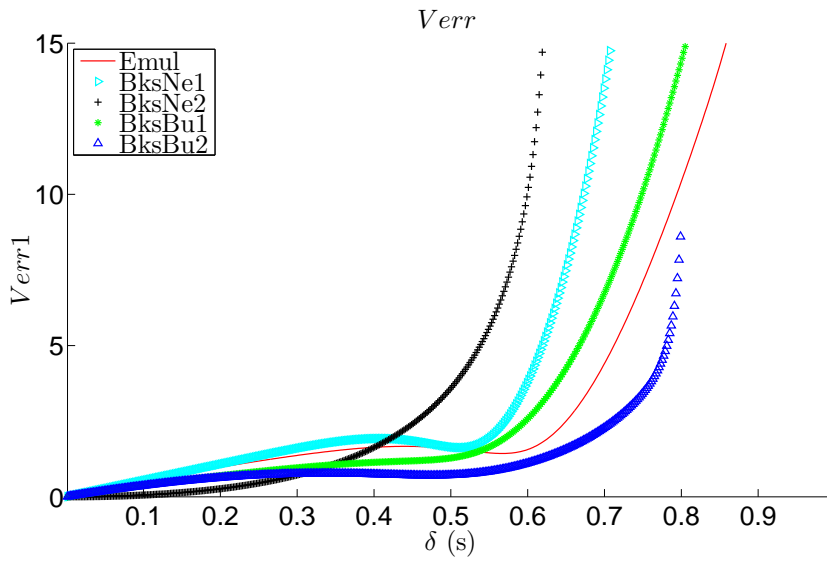

(a) Lyapunov V error matching

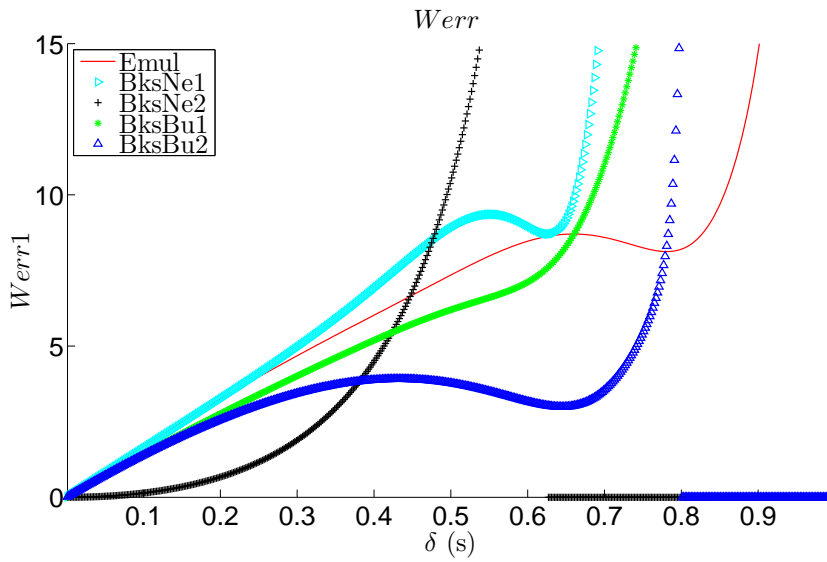

(b) Lyapunov W error matching

Figure 4.10: Lyapunov error matching results for the compared algorithms (For comparative purposes see Figure 4.5)

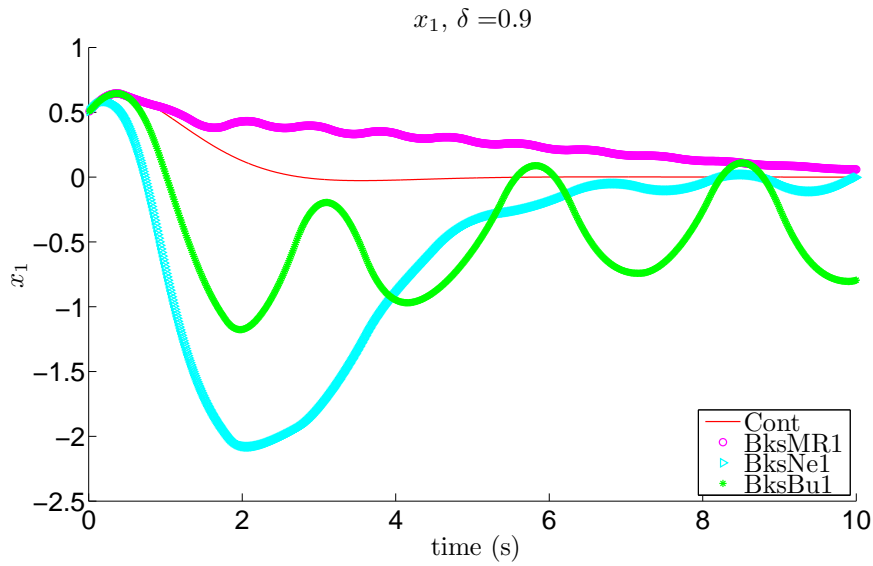

(a) x_1 state evolution

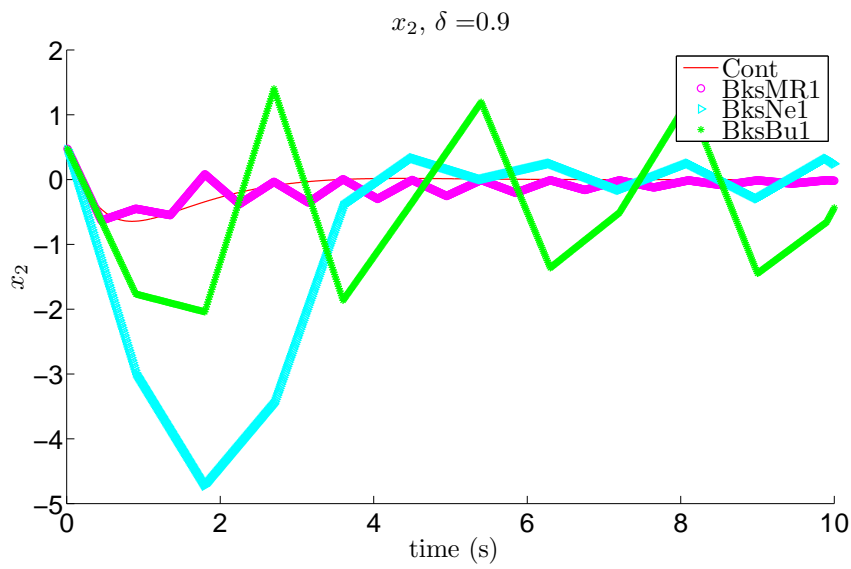

(b) x_2 state evolution

Figure 4.11: States evolutions for compared algorithms, $\delta = 0.9s$

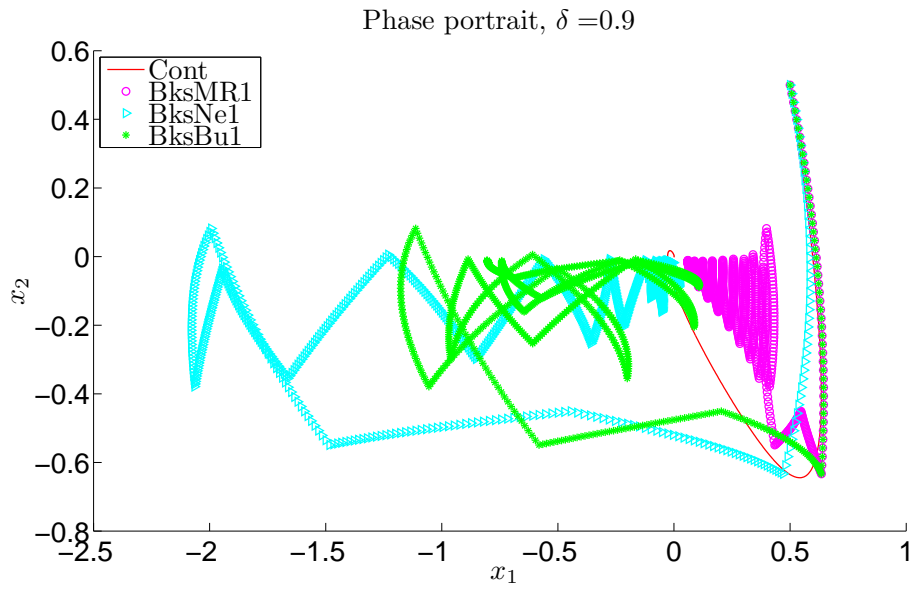

(a) Trajectories

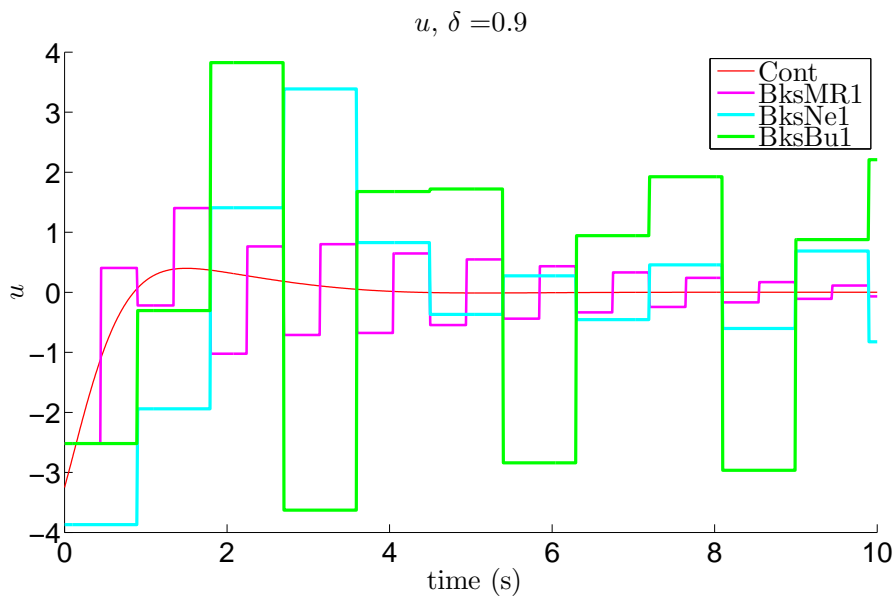

(b) Control

Figure 4.12: Simulation results for the compared algorithms of first order, $\delta = 0.9\text{ms}$

4.5.2 The strict feedback system with double integrator

Let us, next, illustrate the benefit of a 3-rate controller on the 3 order system already worked out in sections 4.2.3 and 4.3.4. Let us recall the main results computed previously, expressed in the initial system coordinates.

$$\dot{x}_1 = x_1^2 + x_2 \quad (4.93)$$

$$\dot{x}_2 = x_3 \quad (4.94)$$

$$\dot{x}_3 = u \quad (4.95)$$

with an initial Lyapunov function $W(x_1) = x_1^2/2$. The continuous-time controller based on the backstepping design,

$$u_c(x_1, x_2, x_3) = -6x_1^4 - 6x_1^3 + (-8x_2 - 5)x_1^2 + (-6x_2 - 2x_3 - 3)x_1 - 2x_2^2 - 5x_2 - 3x_3 \quad (4.96)$$

respectively

$$\begin{aligned} \dot{u}_c(x_1, x_2, x_3) &= 9x_1 + 12x_2 + 4x_3 + 18x_1x_2 + 6x_1x_3 - 6x_2x_3 - 12x_1x_2^2 + 12x_1^2x_2 - 24x_1^3x_2 \\ &- 6x_1^2x_3 + 18x_1^2 + 18x_1^3 + 12x_1^4 - 12x_1^5; \end{aligned} \quad (4.97)$$

and the total Lyapunov function

$$V := V_3(x_1, x_2, x_3) = \frac{1}{2} \left((x_1^2 + x_1 + x_2)^2 + (2x_1 + 2x_2 + x_3 + 2x_1(x_1^2 + x_2) + 2x_1^2)^2 + x_1^2 \right).$$

SINGLE-RATE VERSION The single-rate backstepping of the second order approximated controller (BksSR) is computed with formulas given in Section 4.3.3. In this case:

$$u_d^{\delta^2} = u_{d0} + \frac{\delta}{2}u_{d1} + \frac{\delta^2}{6}u_{d2}$$

with

$$u_{d0} = u_c|_{x_k} \quad (4.98)$$

$$u_{d1} = \dot{u}_c|_{x_k} \quad (4.99)$$

$$\begin{aligned} u_{d2} &= 14x_1^2(x_1^2 + x_1 + x_2) - 17x_2 - 12x_1(x_1^2 + x_1 + x_2)^2 - 15x_1 - 41(x_1^2 + x_1 + x_2)^2 \\ &- 6(2x_1 + 2x_2 + x_3 + 2x_1(x_1^2 + x_2) + 2x_1^2)^2 + 12x_1^2 + 4x_1^3 + (6x_1 + 54x_2 \\ &+ 42x_1^2 + 6x_1(x_1^2 + x_1 + x_2) - 4)(2x_1 + 2x_2 + x_3 + 2x_1(x_1^2 + x_2) + 2x_1^2) \\ &- 12x_1(x_1^2 + x_1 + x_2) - ((x_1^2 + x_1 + x_2)(x_1 + 4x_2 + 12(x_1^2 + x_1 + x_2)^2 \\ &- 14x_1(x_1^2 + x_1 + x_2)))/(4x_1 + 4x_2 + 2x_3 + 4x_1(x_1^2 + x_2) + 4x_1^2). \end{aligned} \quad (4.100)$$

3-RATE VERSION The second approach, involving 3-rates sampling (BksMR) gives,

$$u_{di}^{\delta^3} = u_{di0} + \frac{\delta}{6}u_{di1} + \frac{\delta^2}{54}u_{di2}, \quad i = 1, 3$$

with

$$(u_{d10}, u_{d20}, u_{d30}) = (u_c|_{x_k}, u_c|_{x_k}, u_c|_{x_k}) \quad (4.101)$$

$$(u_{d11}, u_{d21}, u_{d31}) = \left(\frac{3}{4}\dot{u}_c|_{x_k}, 3\dot{u}_c|_{x_k}, \frac{21}{4}\dot{u}_c|_{x_k} \right) \quad (4.102)$$

$$\begin{aligned} u_{d21} = & (306x_1)/5 + (621x_2)/10 + 36x_3 + (36x_1^2)/(2x_1 + 2x_2 + x_3 + 2x_1(x_1^2 + x_1 + x_2)) \\ & - (153x_1x_3)/5 + (216x_1(x_1^2 + x_1 + x_2)^2)/5 - (1089x_1^2(x_1^2 + x_1 + x_2))/10 \\ & + 27x_1^3(x_1^2 + x_1 + x_2) + 36(x_1^2 + x_1 + x_2)^2 + (81x_1^2x_3)/5 - (81x_1^2(x_1^2 \\ & + x_1 + x_2)^2)/5 + (36(x_1^2 + x_1 + x_2)^2)/(2x_1 + 2x_2 + x_3 + 2x_1(x_1^2 + x_1 + x_2)) \\ & + (45x_1^2)/4 + 63x_1^3 - (54x_1^4)/5 - (27x_3^2)/5 - (27x_1(x_1^2 + x_1 + x_2))/5 \\ & + (108x_3(x_1^2 + x_1 + x_2))/5 - (189x_1x_3(x_1^2 + x_1 + x_2))/10 \end{aligned}$$

$$\begin{aligned} u_{d22} = & (1188x_1(x_1^2 + x_1 + x_2)^2)/5 - (6129x_2)/20 - 126x_3 - (126x_1^2)/(2x_1 + 2x_2 + x_3 \\ & + 2x_1(x_1^2 + x_1 + x_2)) - (774x_1x_3)/5 - (1557x_1)/5 - (2691x_1^2(x_1^2 + x_1 + x_2))/5 \\ & + 270x_1^3(x_1^2 + x_1 + x_2) + 198(x_1^2 + x_1 + x_2)^2 + (648x_1^2x_3)/5 - (648x_1^2(x_1^2 \\ & + x_1 + x_2)^2)/5 - (126(x_1^2 + x_1 + x_2)^2)/(2x_1 + 2x_2 + x_3 + 2x_1(x_1^2 + x_1 + x_2)) \\ & + (207x_1^2)/4 + 306x_1^3 - (702x_1^4)/5 - (297x_3^2)/10 - (3186x_1(x_1^2 + x_1 + x_2))/5 \\ & + (594x_3(x_1^2 + x_1 + x_2))/5 - (621x_1x_3(x_1^2 + x_1 + x_2))/5 \end{aligned}$$

$$\begin{aligned} u_{d23} = & (711x_1)/5 + (3267x_2)/20 + 198x_3 + (198x_1^2)/(2x_1 + 2x_2 + x_3 + 2x_1(x_1^2 + x_1 + x_2)) \\ & - (3393x_1x_3)/5 + (5076x_1(x_1^2 + x_1 + x_2)^2)/5 - (23769x_1^2(x_1^2 + x_1 + x_2))/10 \\ & + 999x_1^3(x_1^2 + x_1 + x_2) + 846(x_1^2 + x_1 + x_2)^2 + (2511x_1^2x_3)/5 - (2511x_1^2(x_1^2 \\ & + x_1 + x_2)^2)/5 + (198(x_1^2 + x_1 + x_2)^2)/(2x_1 + 2x_2 + x_3 + 2x_1(x_1^2 + x_1 + x_2)) \\ & + 234x_1^2 + 1359x_1^3 - (2484x_1^4)/5 - (1269x_3^2)/10 - (6507x_1(x_1^2 + x_1 + x_2))/5 \\ & + (2538x_3(x_1^2 + x_1 + x_2))/5 - (5049x_1x_3(x_1^2 + x_1 + x_2))/10. \end{aligned}$$

(4.103)

SIMULATIONS The simulation parameters are given in Table 4.3. In the Figures 4.13, 4.14 there are plotted the evolutions of the Lyapunov functions, of the controllers and of the state variables x_1, x_2, x_3 . The second-order approximated controllers offer the best results for both approaches single and 3-rates.

sampling period	initial conditions	simulation time length	Figure labels
$\delta = 0.4$ s	$x_0 = [0.5 \ 0.5 \ 0.5]$	$t_f = 10$ s	Figures 4.13, 4.14
$\delta \in [0.01, \dots, 1]$ s	$x_0 = [0.5 \ 0.5 \ 0.5]$	$t_f = 10$ s	Figures 4.15

Table 4.3: Numerical values of the simulation parameters- Example 4 -single and multi-rate controllers

In Figure 4.15 there is plotted the Lyapunov matching error criteria when evaluating the V and W matching on each sampling instants. It is clear that the 3-rates versions offer better results for large intervals of δ . For lower sampling periods, single-rate version can offer lower errors level than the 3-rates version.

If we compare these results with the ones obtained for the system (4.78)-(4.79) one can conclude the following. This example is interesting, because highlights a known fact from the continuous-time context: adding an integrator in the controls path slows the response of the first dynamic to the input changes. For this reason, the backstepping design for the third-order system could be improved by increasing the design gains. Any increase of the control gains reduces the maximum admissible sampling period for the emulated solutions. In this example, we choose to use the same gains for both situations, in the idea to not impose additional constraints on the sampling period. The supplementary integrator had reduced the maximum admissible sampling interval of the emulated solution from [0..9] to 0..5 seconds. This degradation is also reflected in the case when employing the digital controller, here proposed, with one exception: the multi-rate version of the second order approximation. This solution has almost the same performances in the case of 1 or 2 integrators in the control inputs. This fact confirms the theoretical assumptions, and represents a suitable solution for the systems with chains of integrators.

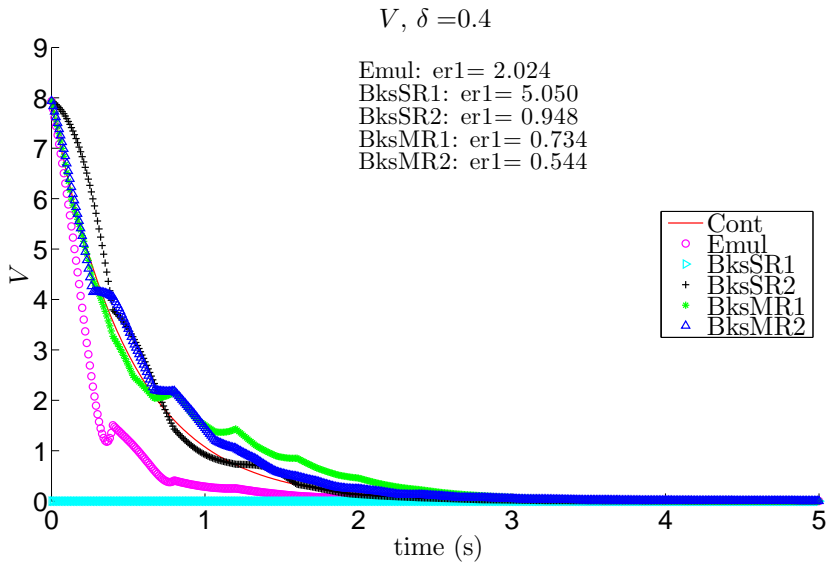

(a) Lyapunov V evolution

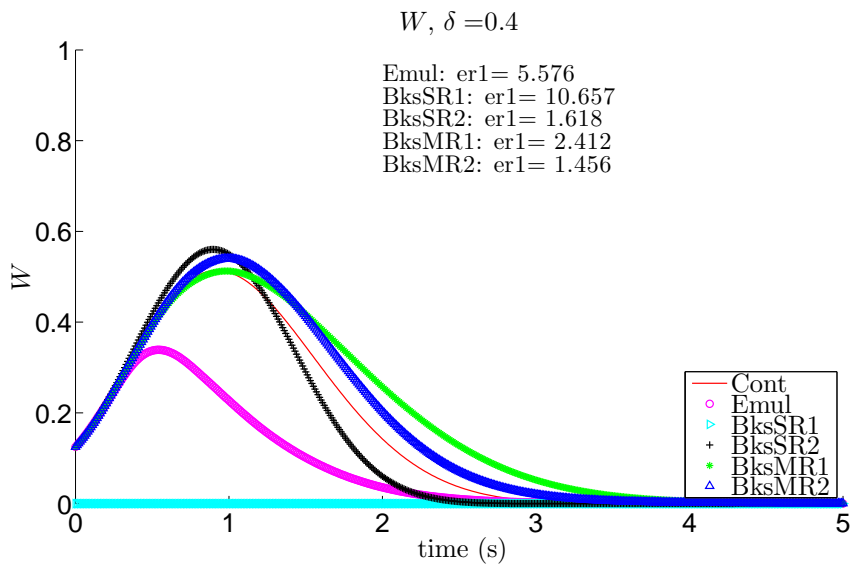

(b) Lyapunov W evolution

Figure 4.13: Lyapunov evolutions for proposed algorithms - double integrator, $\delta = 0.4s$

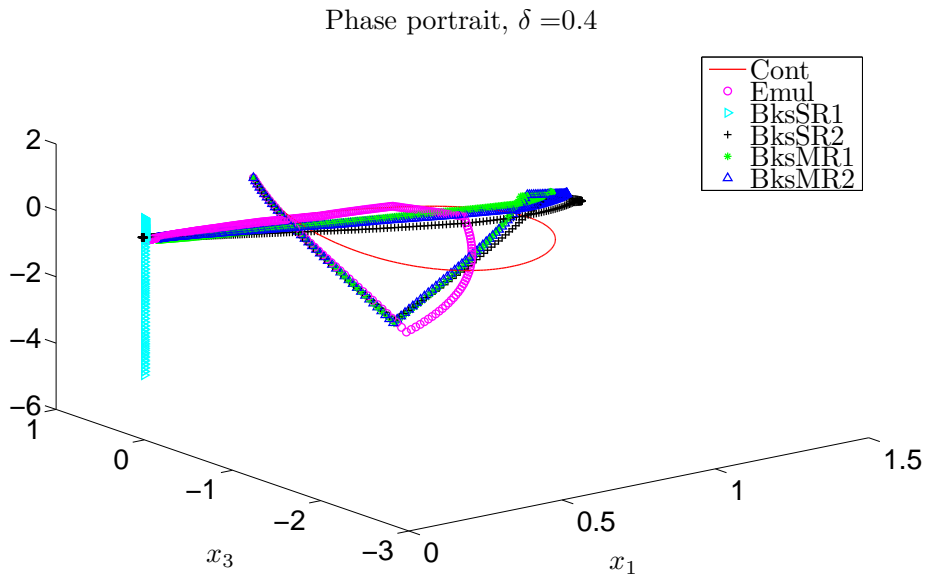

(a) Trajectories

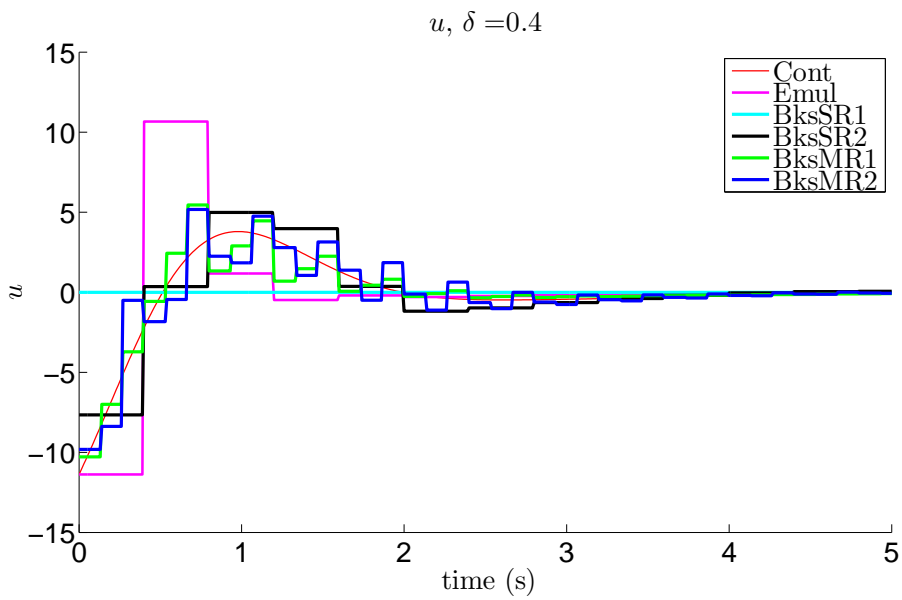

(b) Control evolution

Figure 4.14: Simulation results for the proposed algorithms -double integrator, $\delta = 0.4s$

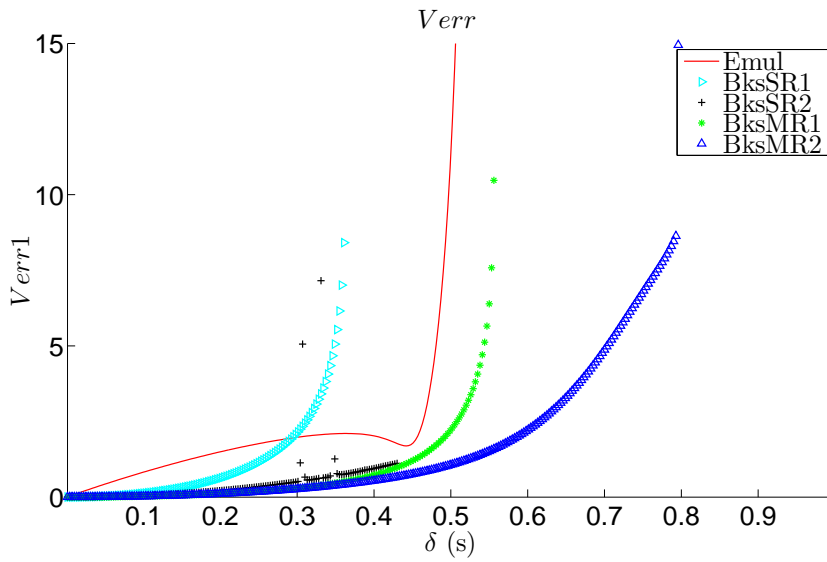

(a) Lyapunov V error matching

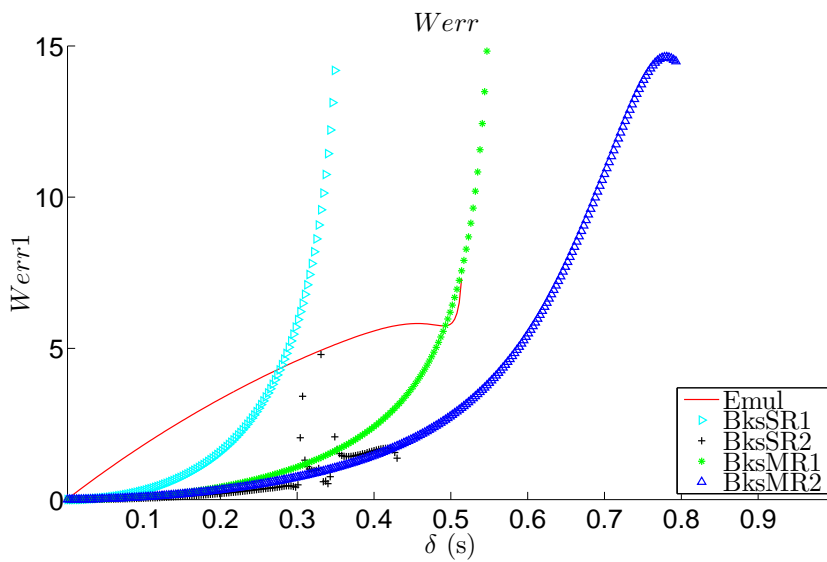

(b) Lyapunov W error matching

Figure 4.15: Lyapunov error matching results for the proposed algorithms - double integrator

Part II

SIMNLSYS - SAMPLED-DATA CONTROLLER DESIGN TOOLBOX

SIMNLSYS SOFTWARE TOOLBOX

This chapter describes the SimNLSys software toolbox, developed to assist the design of sampled-data controllers. The software proposes a number of modules which cope with different design strategies such as: multi-rate control, input-output/Lyapunov matching, backstepping controller or optimal control. The digital design is worked out for nonlinear input-affine systems and the resulting controllers are expressed as symbolic expressions that can be used for simulation tests.

The toolbox offers also a dedicated module for simulations of sampled-data systems and allows a number of predefined analysis concerning the evaluation of performance indicators in terms of sampling period and static gains of the controller. Part of the presentation of the software and its algorithms are included in the paper [Co1],[Co3] from the author's contribution list (page ix).

5.1 THE TOOLBOX OBJECTIVES AND STRUCTURE

The proposed **CADC** software -**SimNLSys**- is built as a Graphical User Interface (GUI) application in Matlab¹. This software combines graphical features of a GUI application with solutions provided by the numerical and symbolic tools. Its main goals are twofold:

- to support the design of sampled-data controllers for a number of available nonlinear control designs;
- to provide specific simulations and performance evaluations tools for the proposed sampled-data controllers, in a comparative test spirit;

SimNLSys is designed as a Matlab design toolbox for sampled-data feedback nonlinear controllers.

This specificity makes the proposed software application fill the gap that exists in the context of

¹ A MathWorks product <http://www.mathworks.com/products/matlab>

nonlinear sampled data control systems. This is discussed in the literature survey performed in the first chapter, where other similar toolboxes have not been reported up to this date. The basic idea is to compute automatically symbolic expressions of the controllers, starting from the continuous state dynamics of the system and following a specific methodology. The framework developed by Salvatore Monaco and Dorothée Normand-Cyrot [Monaco & Normand-Cyrot 2001, Monaco *et al.* 2007, Monaco & Normand-Cyrot 2007], [Monaco & Normand-Cyrot 2009, Monaco *et al.* 2011] offers specific results that make it possible the design of symbolic algorithms. Consequently, the resulting expressions can be used in a real-time application for controlling a physical plant. In this way, this toolbox represents in my opinion a necessary link between theory and practical applications.

As pointed out by the objectives, the second feature of the SimNLSys application is represented by the simulation tools. These tools, which implement numerical algorithms, provide specific tests for sampled-data systems and evaluate, under some defined criteria, the controller's performance computed by the SimNLSys designer.

The structure of the SimNLSys is given in the [Figure 5.1](#)

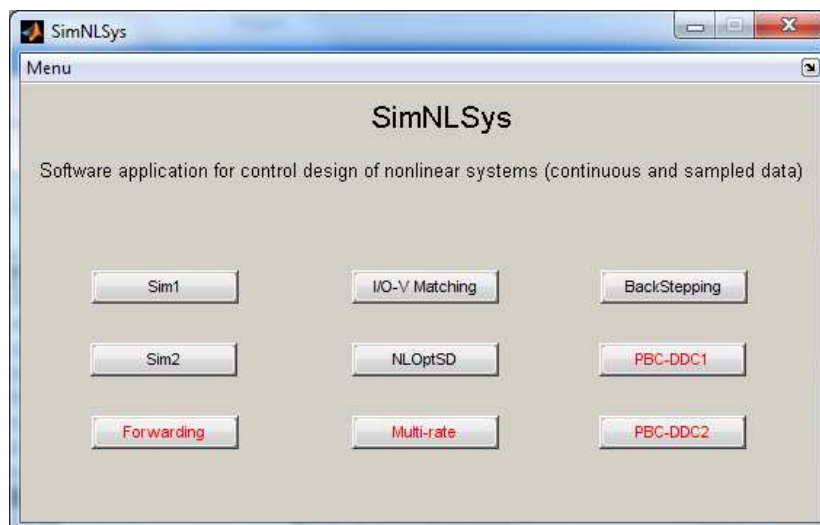

Figure 5.1: Main window of SimNLSys

The software architecture drives several modules:

- design toolboxes
 - input-output/ Lyapunov matching - **IOMatch**
 - backstepping design - **Bks**
 - optimal nonlinear control - **NLOptSD**

- simulation toolboxes - **Sim1**, **Sim2**

Other modules such as: **Forwarding**, **PBC** are in course of implementation.

5.1.0.1 Control design modules

The controller designs are based on the capabilities of the symbolic toolbox of Matlab. The use of symbolic tools brings a great benefit for the CAD applications and for any person engaged in research or industrial activities who can handle complex expressions and calculus. The absence of rounding and cumulative errors, specific to the numerical case, and the symbolic expression manipulations give the advantage of this tool in the design of nonlinear control using differential geometry.

In the SimNLSys application, the Matlab symbolic toolbox (currently connected to a MuPAD engine) is used to compute the expressions of the digital controls. These expressions, obtained in a symbolic form, are needed further on for being implemented on control devices.

It was necessary, at first to define some basic functions that compute the Lie derivative, the Jacobian, the Lie bracket or the inverse of a multidimensional function. Close attention was paid to the matrix manipulations that are critical in the **MIMO** case.

In the following sections, the presentation is focused on the symbolic algorithms development for the problem of input-output matching which represents the core of the subsequent algorithms. The algorithms that have been derived from this are the input-Lyapunov matching method and the backstepping design which rely on the same concepts of the Lyapunov matching. Interesting results are also given in the computation of multi-rate controllers where the most complex computations are due to expansion of the **BCH** exponents.

5.1.0.2 Simulations modules

The toolbox provides two simulation modules, one for the case of single-rate controller versions (**Sim1**) and the other one which handles more difficult scenarios as multi-rate controllers, or nonlinear systems with constraints or include other static nonlinearities that do not fit with the definition of input-affine dynamics.

The development of this toolbox is in a continuous progress at the same time with new theoretical achievements. Each module architecture can be described by its three components:

- *User level* - the software interface, where the data are specified and the results are displayed.
- *Code level* - represented by the designed algorithms and by the run-time behavior.
- *Data level* - represented by the resulting data.

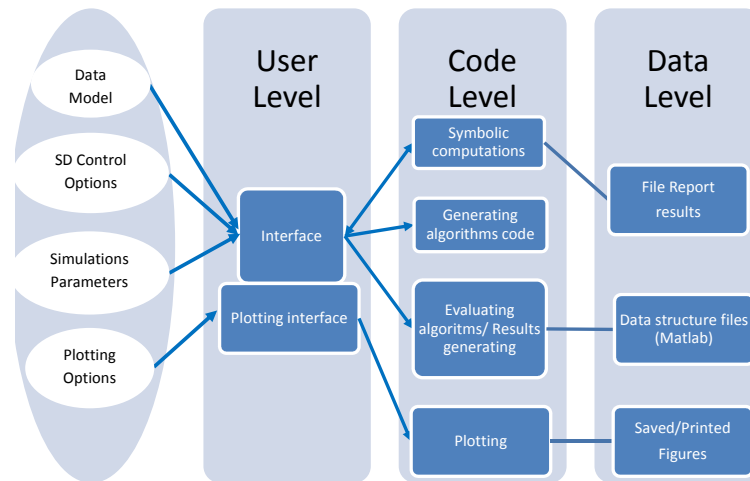

Figure 5.2: Software diagram

In [Figure 5.2](#) the work-flow of the entire SimNLSys application is depicted. A user interacts with the application through the interfaces where he can specify the input data (process model, simulation parameters), and then computes the resulting data (controller expressions, data files, image files). At the last step, he can use the tools provided by this software in order to visualize, save or print the resulting data. The resulting data can be used for other manipulations in Matlab. All the algorithms used in this application are assigned to the “code-level”, inaccessible to the users.

5.2 THE SIMULATION TOOLBOX

5.2.1 Simulation of sampled-data systems

The simulation modules of **SimNLSys** are developed in order to test the performance of the computed control solutions. The simulation of closed-loop sampled-data systems considers the following aspects:

- the system’s behavior in continuous-time;
- the controller computation performed at discrete-time instants;
- the reconstruction of the input continuous-time signal from the digital signal - which comes from the controller’s output, which is accomplished by means of [ZOH](#) devices.

A real continuous-time simulation cannot be performed on computer systems since its operate at specific discrete-time instants. Nowadays, computer systems permit very fast computations and the availability of viable numerical algorithms makes it possible the “emulation” of continuous-time

systems on digital systems. The usual assumption is that the simulation of the emulated systems is considered to give the same results as the real continuous-time one, if the integration of the solutions are performed with reduced integration step and respectively with negligible errors.

The best solution to compute the solution at specific discrete-time instants, when dealing with nonlinear continuous-time dynamics, is to employ numerical algorithms such as the Runge Kutta class (Section 1.3.7.2). Another solution is to exploit the exact discrete-time equivalent of the continuous-time system. This solution would give exact results but only in those cases where such discrete-time equivalents do exist.

In Table 5.1 there is given the pseudo-code of the algorithm which simulates a sampled-data control structure. The first step is the initialization when the initial conditions are specified for the simulation

```

initialization ( $x(0), u_d(t_k, x_k)$ )
for  $k = 0 : \delta : t_f$ 
    hold  $u_d(t_k, x_k)$ 
     $x_{k+1} = \text{ODE45}(\text{Sys}(u_d), x(k), k\delta, (k+1)\delta, d)$ 
    sampling ( $x((k+1)\delta)$ )
end for

```

Table 5.1: Sampled-data algorithm

and the analytical expressions of the controllers are computed. In the outer loop the hold and sampling operations are simulated. The current value of $u_d(k)$ is assigned depending on the previous measures of the state (or depending on the initial conditions) and thus is applied to the process. For the inner loop, the control input is kept constant over δ and the system behavior is integrated for each step δ . The integration is performed by means of the ODE45 function available in Matlab. This function is parametrized by the systems describing equations, the initial value, the initial and final time of the integration and information about the integration step - d . In these simulations d has a reduced value, lower than δ , and it is adapted accordingly during the evaluation time. At time instants $(k+1)\delta$ the algorithm leaves the ode solver and the state measures are updated. The simulation runs up to final time value t_f that is specified by the user.

When one considers to evaluate the performance of the sampled-data controllers issued from the input/output or input/Lyapunov matching design, one must report this performance to continuous-time controllers one. Because most of the digital designs proposed in **SimNLSys** aim to recover, under sampling, the performance of continuous-time controllers then the simulation tools also include this feature. In this case, the closed loop system is entirely continuous and it can be described by ODEs.

Remark 47. *In extenso, the integration algorithm works also for MIMO systems and for control inputs u that have time as independent variable.*

5.2.2 Sim1 toolbox

The module is designed for nonlinear MIMO systems with affine inputs. The functions accepted are those specified in the introductory chapter: f , g , h , V and respectively the controller u . Regarding the syntax specifications - please refer to Section 6.1.4. There are no software limitations for the number of state variables. The limitations are due to computing and simulations time constraints. The module performs some test in order to verify the dimensional consistency of the functions. The control may have some constraints, it can be expressed depending on the state variables and also on the time variable. The initial state point must be given for simulation and integration purposes.

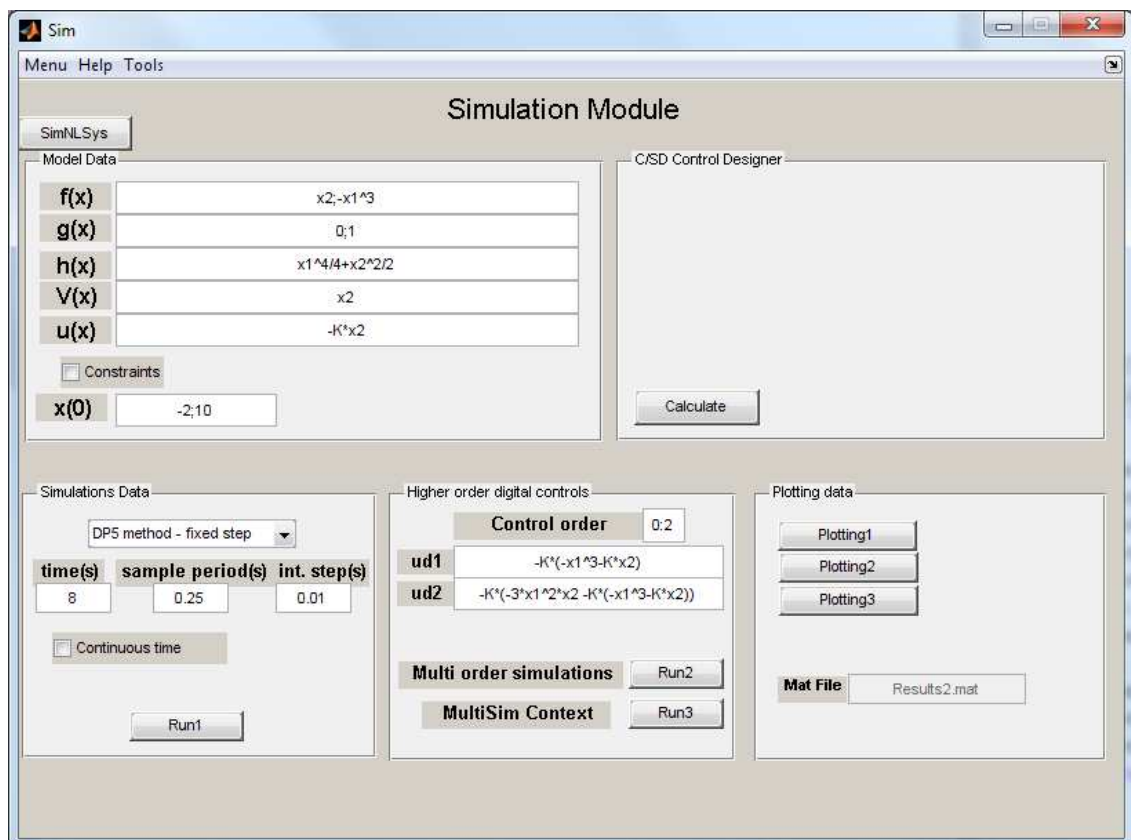

Figure 5.3: Main window of Sim1

5.2.3 *Simulation scenarios*

The software provides simulations for two classes of nonlinear dynamical behaviors: continuous-time and sampled-data. For these simulations, the integration step d , the sampling period δ and the time length of the simulation are specified. The value of δ is not considered for a continuous-time simulation and the integration step must be very small. For sampled-data simulations, a recommended condition is $\delta \gg d$. This toolbox offers multiple simulation scenarios.

- a single simulation, for a given δ and a given control; this simulation can be performed considering either a continuous-time or a digital controller, by setting accordingly the 'continuous-time' check box.
- 5 simulations in 1 - for a fixed value of δ , 5 simulations are performed successively for the same plant, for each type of control considered: continuous-time, emulated, first, second and third order approximation controllers; the simulation module evaluates for each control the performance indicator for comparative purposes;
- multi-simulations - for a range of δ , and for a range of the control parameter K there are performed the same 5 simulations as the ones indicated previously; these simulations are time consuming and offer results about the admissible sampling periods, or controller gains with a specific performance; these results are usually plotted in a 3D view to highlight the regions where a specific control performs better.

The toolbox offers a series of plotting tools in order to visualize and to compare the performance of each controller. Some plots will deliver the control input, the state, the output or the Lyapunov evolutions in different formats. Also the simulations results are saved in ".mat" type files that can be used afterwards for other manipulations.

5.2.4 *Performance indicators*

For analyzing the controller performance, different criteria have been proposed. One type of criteria are derived to evaluate the input/output or input/Lyapunov matching error. In this case is said that the controller performance are reported with respect to the continuous-time ones. Another type of criteria are used to quantify the digital controller performance like energy measures.

5.2.4.1 Matching Criteria

All the criteria are derived around evaluating the absolute difference $h(x_c(t))|_{t=k\delta} - h(x_k)$ at each sampling instant, where h is the output function or the Lyapunov function.

- The most common criterion used in this toolbox is the cumulative squared relative error, defined as follows:

$$\text{err1} := \sqrt{\frac{\sum_{k=1}^N |h(x_c(t))|_{t=k\delta} - h(x_k)|}{h(x_c(0))}} \quad (5.1)$$

This criterion counts for all errors mismatches between these two evolutions, at each sampling instant. This error also depends on the N , the number of samples counted.

- Another criterion used counts for the maximum mismatch:

$$\text{err2} := \max_{k=1:N} |h(x_c(t))|_{t=k\delta} - h(x_k)| \quad (5.2)$$

There are many situations when this indicator can provide bigger values compared to the previous error criterion. For example for systems with big overshots which decay rapidly to the equilibrium point.

- Another criterion that counts most for the earlier terms of the mismatches:

$$\text{err3} := \sum_{k=1}^N |h(x_c(t))|_{t=k\delta} - h(x_k)| \cdot \exp\{-k/c\} \quad (5.3)$$

This criterion does not count for terms when k is sufficiently large. This criterion could be of great interest to better distinguish the controllers with close performance and which assure stabilization of the controlled system. The emphasis is laid at the beginning of simulations when the controller acts very active.

The first criterion was used in the controller performance evaluations in the examples provided in [1.3.8](#), [Section 4.5](#) or in the case studies chapters.

5.2.4.2 Energy performance criteria

When the controller performances are not subjected with respect to some continuous-time performances, other criteria are useful for quantifying the performances.

- Tr - The time necessary to ultimately bound the evolution to four percent of the norm of x_0

$$Tr = \min_{t>0} \{t | \forall \tau > 0 \quad |x(t + \tau) - x_0| \leq 0.04|x_0|\} \quad (5.4)$$

- The controller energy - E_u :

$$E_u = \int_0^{Tr} u^2(t) dt \quad (5.5)$$

- The norm of the state evolution

$$E_x = \int_0^{\text{Tr}} \|\mathbf{x}(t)\| dt \quad (5.6)$$

5.2.5 *Sim2 toolbox*

The second simulation toolbox, included in **SimNLSys** application, is developed for more complex simulations. This requires, to the user, supplementary knowledges of the Simulink toolbox and of the Matlab scripting. This module is designed by means of Simulink modules where more complex nonlinear systems can be defined, e.g. systems with constraints, with nonstandard nonlinearities, etc. Also, this module is adapted for multi-rate controller simulations. This particular case was not implemented in **Sim1** due to its complexity. The scripts are defined here for simulating the same scenarios as indicated in the previous sections.

CONTROL DESIGN ALGORITHMS

In this section the algorithms used for computing the controller solution in the case of the input-output/Lyapunov matching and respectively the backstepping methodology are detailed. The precise limits on the class of systems for which the solutions are computed, are given. Some discussions and perspectives about the practical development of the algorithms are also presented.

6.1 INPUT/OUTPUT AND INPUT/LYAPUNOV MATCHING

Under these names “Input/Output matching” and “Input/Lyapunov matching” are referred two sampled-data designs which are similar in terms of computability, but different in terms of stabilizing properties. The first strategy, the input-output matching, has as the objective to match an “output”-mapping, usually denoted by the h function. The second method, the input-Lyapunov matching strategy, replaces the h function with a Lyapunov function usually denoted by V . The first method can find interesting applications in the passivity based control where the passivity of a specific input-output link is a basic aspect. The second method which is widely discussed in Chapter 3, is convenient to deal with the stabilizing properties of a controlled system.

Because the symbolic algorithm makes no difference between these two strategies¹ (between the h and V functions respectively) a single module was designed to deal with these approaches. The main window of the **IOMatch** module is depicted in [Figure 6.1](#).

It can be seen in [Figure 6.1](#) that a check box item selects the desired method - if one counts for the h matching or for the V matching. The algorithm is developed in 3 versions, depending on the number

¹ The algorithm considers that the function to be matched is smooth with no other extra properties as it is the case for an output map h . The same conditions are applied on the Lyapunov functions, in spite of the fact that this map has particular properties such as: V is positive (semi) definite and its derivative is negative (semi) definite. This property may be exploited in other future developments.

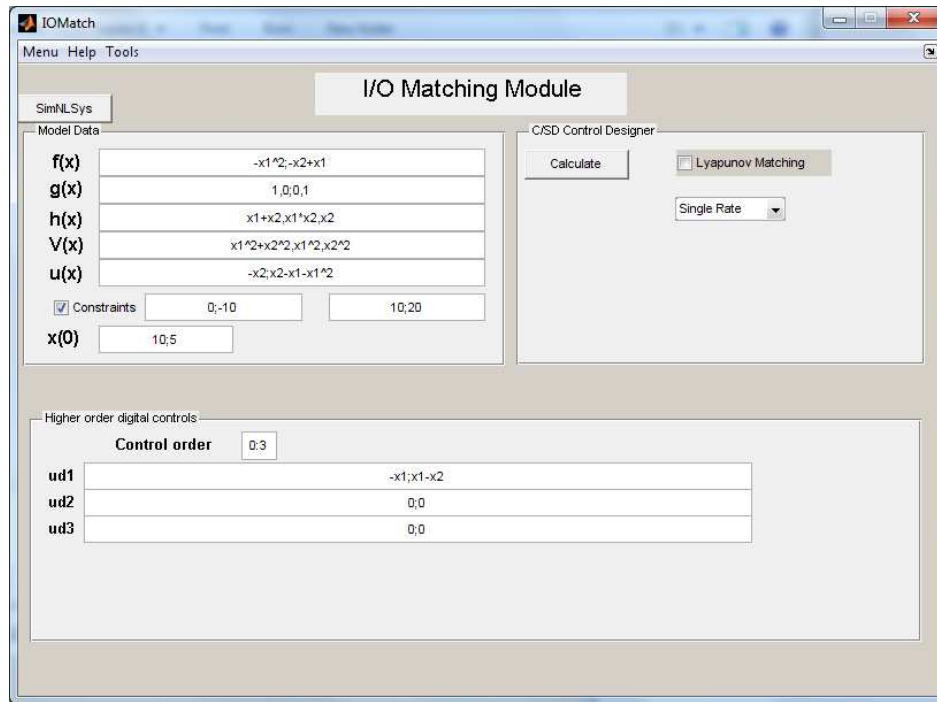

Figure 6.1: IOMatch Module of SimNLSys

of the “rates” of the digital controller. In the following section, the symbolic algorithm in the case of Lyapunov-matching, in the single-rate case is presented.

6.1.1 Single-rate algorithm

The solution proposed here is developed for the case of MIMO nonlinear affine-inputs systems. It is considered that the system is driven by m inputs and that p outputs maps are available. Consequently, in the case of Lyapunov matching, the condition is that the same number p of Lyapunov functions should be defined.

A first idea is to develop a symbolic algorithm that computes the first terms of the controller (3.4) in terms of Lie operators. This algorithm should provide the expressions of the controllers in terms of V , f , g or u as in (3.9)-(3.11). At a second step, these operators are expressed through the specific expressions of these functions and the controller expressions are computed in terms of the state variables. This strategy was not applied in this toolbox because the Matlab symbolic toolbox is not applicable in order to operate and define non-commutative operators. To solve this problem, a symbolic algorithm should be derived from the available tools provided by the MuPad engine. Also such an algorithm could provide more complex expressions and an increased time of computations.

A better solution, that was implemented, avoids the direct implementation of the operators expressions as (3.9)-(3.11) and after that, their evaluation. The proposed solution solves the equality (3.7) and

obtains the expression for the controller terms directly in the system state variables. The algorithm starts with the initialization of the functions V , f , g and u . The algorithm is developed in terms of these generic functions, while the computations are performed involving particular expressions of such functions.

The code presented below is working with symbolic variables and it is implemented for the case of MIMO systems. The series expansions are truncated at the 4th order and the controller components are computed up to the 3rd order of approximations.

```

1. syms ud ud0 ud1 ud2 ud3
2. P(1)=V(x); D(1)=P(1);
3. for i=1:3
4.     P(i+1)=jacobi(P(i))*(f+g*u);
5.     D(i+1)=jacobi(D(i))*(f+g*ud);
6. end
7. Vc= P(1)+d/2*P(2)+d^2/3!*P(3)+d^3/6!*P(4);
8. Vd= D(1)+d/2*D(2)+d^2/3!*D(3)+d^3/6!*D(4);
9. Vs=subs(Vd,ud,ud0+d/2*ud1+d^2/6*ud2+d^3/6!*ud3)
10. [c t]=coeffs(Vs-Vc, d);

```

The higher time-derivatives of the Lyapunov function are computed in the case of continuous-time evolution (the P_i term) respectively for the sampled-data evolutions (the D_i term). The subs function substitutes the symbolic ud variable with its series expansion at the 3rd order. The last statement differentiates the terms from equality (3.7) for each power of δ . In fact it is the equivalent representation of equation (3.5). This result can be rewritten as follows:

$$R(x_k) * \begin{bmatrix} u_{d1i} \\ u_{d2i} \\ \vdots \\ u_{dmi} \end{bmatrix} = \begin{bmatrix} E_{1i}(x_k) \\ E_{2i}(x_k, u_{d1i}) \\ \vdots \\ E_{pi}(x_k, u_{d1i}, \dots, u_{d(p-1)i}) \end{bmatrix} \quad i \in [0, 3] \quad (6.1)$$

where $R(x_k)$ depends on the state variables x_k , m and p as previously defined and E_i is a matrix of the symbolic expression of dimension $(p, 1)$ and i is the order of the controller. In this way, the solution to the proposed problem is translated into a linear equality solving problem. It can be noticed that the l -th element E_{li} ($1 \leq l \leq p$) depends on x_k and on u_{dj} , where $j \in [1, \dots, l-1]$. To solve the linear equality it is necessary to compute the solution starting from $l = 1$ and $i = 0$. Another way is to rewrite the system by rearranging the u_{dij} coefficient terms in the left side as:

$$A(x_k) * \begin{bmatrix} u_{d1i} \\ u_{d2i} \\ \vdots \\ u_{dmi} \end{bmatrix} = \begin{bmatrix} F_{1i}(x_k) \\ F_{2i}(x_k) \\ \vdots \\ F_{pi}(x_k) \end{bmatrix} \quad i \in [0, 3] \quad (6.2)$$

After renaming the new matrix by $A(x_k)$ (in the same way as [Isidori 1995]) - one finds the relative degree matrix for the MIMO case (3.34). When the A matrix is defined, then 3 situations are possible, also discussed in Section 3.5

- $A(x_k)$ is square and nonsingular (i.e. $m = p$, the number of Lyapunov functions is equal with the number of inputs) then there exists a unique solution $u_{di} = A^{-1} E_i$.
- $A(x_k)$ is a wide matrix (i.e. $p < m$) and AA^T is nonsingular then a solution can be computed by using the pseudo inverse of A such that $u_{di} = A^+ E_i$
- A is a tall matrix (i.e. $p > m$) and $A^T A$ is nonsingular then a solution can be computed by using the pseudo inverse of A such that $u_{di} = A^+ E_i$. Another solution, for this case, is to build a multi-rate controller.

The proposed toolbox offers solutions to the first two cases. For the third case, in some particular cases, 2 or 3 rates controller solutions are detailed at the end of this section.

The software is thus capable to offer a solution when the system has higher relative degree (Section 3.4). The resulting A matrix (the relative degree matrix) is invertible and it is computed from line 10 of the above code, after the simplifications have occurred in the computations of the Lyapunov differences.

6.1.2 Algorithms limitations

The symbolic algorithm, presented here gives a general solution for the MIMO nonlinear systems. Difficulties arise when the model expressions and the A matrix are more complex. Even though the symbolic algorithm reduces the problem to solving a linear set of systems, this could be a rough case when the complexity of the involved expressions increases. For many textbook or practical examples, **SimNLSys** has been satisfactory worked out, and many applicative studies have been performed (see Part iii or the examples from [Tiefensee 2010]).

For quite complex simulated examples, control solutions at 2nd order of approximation can be computed in a reduced amount of time, on a PC with good performance. When using optimizers (e.g.

command `simple` in the Matlab symbolic toolbox) in order to reduce the expressions complexity, this time increases significantly. Unfortunately there are situations when the `simple` command does not find the best solutions. An important improvement could be a good management between reducing the expression complexity and reducing the computational time.

Another issue that give difficulties is related to the non singularity of the matrix A . The symbolic algorithm will find an inverse for A , expressed in terms of state variables. But this inverse could not be defined for some points of the state trajectories. This problem will arise only in the “on-line mode” (in real-time control or in simulations) when the control solution has to be evaluated.

Some of the difficulties raised from the papers of [de Jager 1995] or [Besançon & Bornard 1997] such as the computational time or memory saturation are today reduced (but remain important) thanks to the performance advances of the computing systems in terms of speed and memory availability.

SimNLSys is developed as a toolbox, not as a real-time application, and for this reason the computing time of these expressions is not critical. What is critical is the complexity of the control expressions. These expressions are used in real-time applications, where the evaluation time and the cumulative errors could be significant. Taking this into account, more attention should be paid on the symbolic algorithm design. When considering the effects of quantization that can be critical in such controllers a case study is dedicated to this problem in [Chapter 11](#).

Remark 48. *The design of the control law u_d^δ according to (3.4) up to some specific approximation order P is performed “off-line”, because this step is decoupled from the simulation or experimental process. Only the evaluation of the control input at the sampling instants is performed on-line from the data. This significantly reduces the on-line computing time.*

6.1.3 Two and Three-rates algorithms

This is the case when considering that the control input is evaluated l -time faster than the sampling operation. The **IOMatch** module also incorporates two algorithms that deal with the case when $l = 2$ or 3 . These algorithms were developed on [SISO](#) systems. In such situations, the multi-rate control offers extra freedom degree. For the problem in hand, many solutions were possible, but the criteria used to design such controllers are the following:

The Lyapunov matching condition is imposed at intermediate steps between the sampling instants such that:

$$V(x_c(t))|_{t=(k+i/l)\delta} = V(x_{k+i/l}), \quad i = 1, \dots, l \quad (6.3)$$

The next piece of code details the algorithm used for the case of the 3-rate controller.

```

1. syms ud1 ud2 ud3
2. P(1)=V(x); Vd=P(1);
3. for i=1:3
4.     P(i+1)=jacobi(P(i))*(f+g*u);
5. end
6. Vc= P(1)+d/(2*l)*P(2)+d^2/(3!*l^2)*P(3)+d^3/(6!*l^3)*P(4);
7. for j=1:l
8.     D(1)=Vd;
9.     for i=1:3
10.        D(i+1)=jacobi(D(i))*(f+g*udj);
11.    end
12.    Vd= D(1)+d/(2*l)*D(2)+d^2/(3!*l^2)*D(3)+d^3/(6!*l^3)*D(4);
13.    Vs=subs(Vd,udj=udj0+d/(2*l)*udj1+d/(6*l^2)*udj2);
14.    [cj tj]=coeffs(Vs-Vc,d);
15.    udji=solveLS(cj);
16.    Vc=subs(Vc,{delta},{j*delta});
17. end

```

For generalization purpose the l variable is used, which in this case is equal to 3. The complexity increases in the computation of the sampled evolution of V at each rate step. The resulting 2nd order approximated controller has the form indicated by the relations (4.71). It follows that the problem is translated into solving $l \times r$ linear systems of the form (6.2) over the sampling interval $[k\delta, (k+1)\delta)$, with l the number of rates and r the controller order approximation.

6.1.4 The designer interface

The main window of the **IOMatch** toolbox is depicted in [Figure 6.1](#). The input data specifications are the following:

- the state variables are expressed as “x1”, “x2”, etc;
- the time variable is expressed by “t” and an unknown gain is expressed by “K”;
- the mathematical operators and computation orders are the same as the ones required for the Matlab environment.

- the sign “;” delimits the row components of a numerical or functional matrix, and the sign “,” the column elements;
- all the boxes from “Model Data” have to be filled accordingly, and the function dimensions should have appropriate dimensions;

If the check box “Lyapunov matching” is selected then the algorithms consider the V function instead of h . The pop-up menu allows the user to select the “rate” of the controller. The resulting expressions are given for a maximum third order controller approximation in the corresponding edit-boxes.

6.1.5 Perspectives

Further developments are possible. The multi-rate versions can be also extended to the case of **MIMO** systems. A particular and interesting case should be the non-square **MIMO** systems with lower number of inputs where the multi-rate solution has to be developed from the single-rate solution. In the multi-rate case, other objectives than the matching of the Lyapunov evolution at inter-sampling instants could be imposed.

Another emphasis can be paid in finding expression “simplifier” methods. These simplifiers require big amounts of computations and time. A solution that can be explored is the parallelization of such algorithms.

6.2 BACKSTEPPING DESIGN

The design of digital backstepping controllers is derived from the algorithms developed in the previous case for the input/Lyapunov matching strategy. This strategy is adopted for a particular class of systems called “strict-feedback” (see [Section 4.2.2](#)). The continuous-time backstepping design is fundamental since the digital design relies on it. This is the reason why the control designer toolbox **Bks** includes a frame for the continuous-time design and another one for the digital design. The toolbox considers only the case of systems with one cascade connexion as indicated by the equations (4.1)-(4.2).

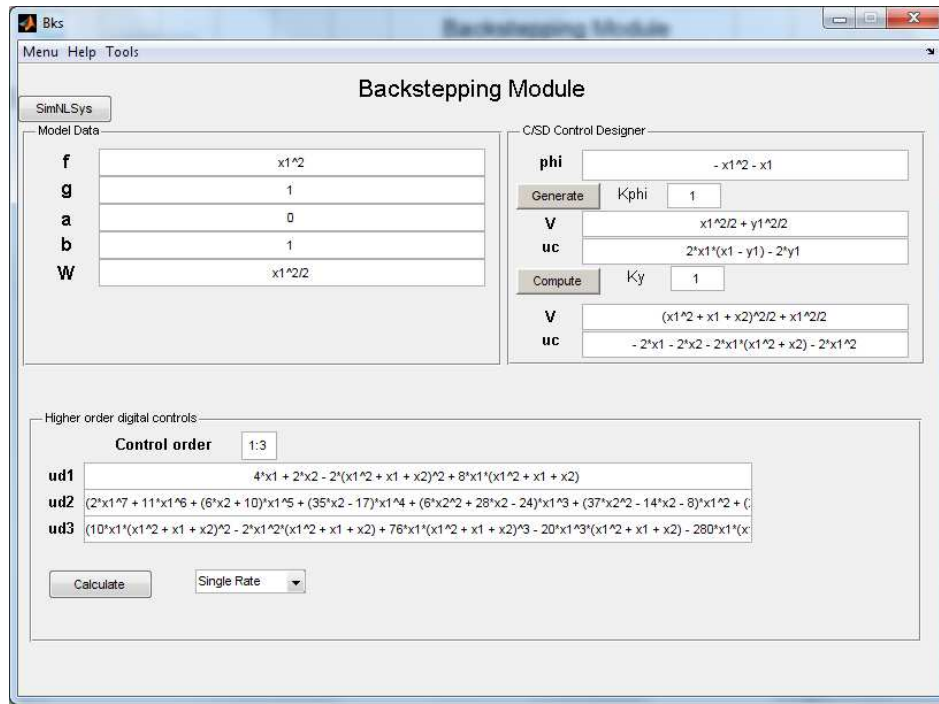

Figure 6.2: BKS Module of SimNLSys

6.2.1 Continuous-time design

Starting from the system definitions with given f , g , a , b and an initial Lyapunov function W , the aim of this designer is to aid the design of a continuous-time controller u_c and a Lyapunov function V which ensures the stabilizing properties of the entire system. In the next lines, the steps for computing these solutions are detailed following the already design explained in Section 4.2. The proposed solution works out for those cases where $z \in \mathbb{R}^n$ and $\xi \in \mathbb{R}$ or $\xi \in \mathbb{R}^n$, with $n \geq 1$. When $\xi \in \mathbb{R}^n$ this case is referred to as a square MIMO system.

Remark 49. In the toolbox designer, the z variable is replaced by the variables x_1, x_2, \dots, x_n and ξ by x_{n+1}, x_{n+2}, \dots . In the following lines, to be coherent with the definitions of Chapter 4, the use of z and ξ will be preferred in place of the x_i notations, as are used in the designer toolbox.

The “fictitious” control $\phi(z)$ can be chosen according to different ways in order to satisfy the conditions of Proposition 38. In the toolbox, it is generated as follows:

- if g is invertible

$$\phi(z) = -g^{-1}f - K_\phi \left(\frac{\partial W}{\partial z} g \right)^T \tag{6.4}$$

- if g is not invertible

$$\phi(z) = - \left(\frac{\partial W}{\partial z} f \right) / \left(\frac{\partial W}{\partial z} g \right) - K_\phi \left(\frac{\partial W}{\partial z} g \right)^T \quad (6.5)$$

The user is allowed to operate changes on the resulting expression of ϕ according to how the nonlinearities will be handled by this “fictitious” input.

The variable y is introduced (with its components y_1, y_2 , etc.) as:

$$y := \xi - \phi(z) \quad (6.6)$$

and the Lyapunov function V is computed as:

$$V := W + y^T y / 2 \quad (6.7)$$

At the last step, the new continuous-time controller is computed as:

$$u_c := b^{-1} \left(-a - \left(\frac{\partial W}{\partial z} g \right)^T - K_y y + \frac{\partial \phi(z)}{\partial z} (f + g(y + \phi(z))) \right) \quad (6.8)$$

The designer express the solutions computed for V and u_c either in terms of x_i (into the initial coordinates) or in terms of the new coordinates x_i and y_i .

6.2.2 Single-rate algorithm

The single-rate algorithm is the same as the one presented in [Section 6.1.1](#). The digital backstepping design procedure is easily converted into the input-Lyapunov matching problem. The initial one cascade connexion system is converted into the y -error representation (see the beginning of [Section 4.3](#)) and then into an affine input representation as indicated in [Section 4.3](#). The Lyapunov function V is now expressed in the same terms as the new state variables of system (4.40). As the idea of the digital design is to find a digital controller u_d such that the continuous-time and respectively the sampled data evolutions of V are matched at least at each sampling instant, then the algorithm proposed in [Section 6.1.1](#) can be applied.

As mentioned earlier, this algorithm also offers solutions for MIMO system:

- the square case: when the number of control inputs equals the dimension of the state z ;
- the multi-input case, when the dimension of z is one and the number of control inputs ≥ 1 .

6.2.3 Multi-rate algorithm

This algorithm follows the method exposed in [Section 4.4.3](#). The same input-matching criteria is applied to the V function but also to the W and to the intermediate V_i functions at the sampling

instants. This solution is quite different from the solution proposed in [Section 6.1.3](#) because it handles multiple different Lyapunov functions. In the next lines, the main code for computing the solution of a 3-rate controller is given. This version is preferred, because it gives a good picture of how the 2-rate or a general multi-rate design looks like. This code is proposed for systems in strict-feedback form with the dimension of the entire states variables equal to the order of the multi-rate solution:

$$\dim(x) = l, \quad x = [z, \xi_1, \dots, \xi_{m-1}] \quad (6.9)$$

```

1. syms ud1 ud2 ud3
2. P1(1)=V2; P2(1)=V1; P3(1)=W;
3. for i=1:3
4.     P1(i+1)=jacobi(P1(i))*(f+g*u);
5.     P2(i+1)=jacobi(P2(i))*(f+g*u);
6.     P3(i+1)=jacobi(P3(i))*(f+g*u);
7. end
8. V1c= P1(1)+d*P1(2)+d^2/(2!)*P1(3)+d^3/(6!)*P1(4);
9. V2c= P2(1)+d*P2(2)+d^2/(2!)*P2(3)+d^3/(6!)*P2(4);
10. Wc= P3(1)+d*P3(2)+d^2/(2!)*P3(3)+d^3/(6!)*P3(4);
11. Vd2=V2;
12. for j=l:1
13.     D(1)=Vd2;
14.     for i=1:3
15.         D(i+1)=jacobi(D(i))*(f+g*udj);
16.     end
17.     Vd2= D(1)+D(2)+D(3)/2+D(4)/6+D(5)/120;
18. end
19. Vd1=V1;
20. for j=l:1
21.     D(1)=Vd1;
22.     for i=1:3
23.         D(i+1)=jacobi(D(i))*(f+g*udj);
24.     end
25.     Vd1= D(1)+D(2)+D(3)/2+D(4)/6+D(5)/120;
26. end
27. Wd=W;

```

```

28. for j=l:1
29.     D(1)=Wd;
30.     for i=1:3
31.         D(i+1)=jacobi(D(i))*(f+g*udj);
32.     end
33.     Wd= D(1)+D(2)+D(3)/2+D(4)/6+D(5)/120;
34. end
35. Vs2=subs(Vd2,udj=udj0+d/(2*l)*udj1+d/(6*l^2)*udj2);
36. Vs1=subs(Vd1,udj=udj0+d/(2*l)*udj1+d/(6*l^2)*udj2);
37. Ws=subs(Wd,udj=udj0+d/(2*l)*udj1+d/(6*l^2)*udj2);
38. [c1 t1]=coeffs((Vs2-V2c)/d,d);
39. [c2 t2]=coeffs((Vs1-V1c)/d^2,d);
40. [c3 t3]=coeffs((Ws-Wc)/d^3,d);
41. udji=solveLS(cj);

```

The three-rate controller of the 2nd order approximation has the form given by equations (4.71). The object of this code is to translate the initial problem into a linear system solving problem with the controllers terms as unknown terms to be computed. Taking into account the lines 39, 40 and 41 - where each coefficient c_j has to be null, then the computation of this solution can be rewritten as $l \times r$ linear systems of the form (6.2), with r as the controller order approximation. For each Lyapunov function V_1 , V_2 and W the continuous-time evolution at instant $k\delta$ is computed in lines 9-11, respectively the sampled-data evolutions in the lines 12-35. In lines 36-38 the controller u_{dj} is replaced by a 2nd order approximation with the unknown terms u_{dji} .

In the **Bks** toolbox it is implemented only the 2-rate version. The higher versions can be employed in the same time with the implementation of the continuous-time controller and Lyapunov functions in the designer. The same issues discussed in Section 6.1.2 or Section 6.1.4 are also valid in this case.

6.2.4 Perspectives

The perspectives that are opened for the problem at hand can be briefly enumerated as follows:

- implementation of the algorithms for digital design when the multi-rate order is higher than 2;
- extensions to the MIMO case of the proposed multi-rate design;

- a new design module (for the multi-rate controller) which uses the algorithm defined in [Section 6.1.3](#);
- a new design module for systems with multiple cascade connections; it should include a design for a continuous-time controller and the multi-rate solution for the digital design.
- new methods that handle symbolic simplifiers and also parallelizing methods.

Part III

CASE STUDIES

MAGNETIC SUSPENSION CONTROL

This case study presents experimental results obtained in a magnetic suspension plant by the use of a single input digital version of backstepping control. The results show that the use of a second order digital controller extends the stabilizing performance of the emulated control in terms of admissible sampling period and of controller's gains. Part of the results reported here are included in the paper [Co4] from the author's contribution list (page ix).

7.1 EXPERIMENTAL PLANT DESCRIPTION

The schematic of the magnetic suspension plant is represented in Figure 7.1 and it is composed with fixed electromagnet powered by a variable current source and a ferromagnetic pendule.

The plant has a perfect symmetry due to the geometry of the constituent elements; this fact is necessary to assure the radial stability. To stabilize the pendulum a variable magnet field is produced. To do this, an electromagnet is used, whose supply current has to be controlled. The axial force F_m produced by the electromagnet is proportional to the square of the current and inverse to the square distance between the pendulum and electromagnet. The equilibrium point position x_0 , where the magnetic force F_m is equal to the weight mg , is obtained for a specific value of the current i_0 . The actuators are the two coils and two current sources with voltage driving. The first coil and current source are used to set the lag of the pendulum (in this case the current is assumed to be constant), and the second coil and current source are used to control the displacement of the pendulum. The control voltage is within the range of $[-10V, 10V]$. The position transducer has a linear characteristic, a good resolution and a proper rejection of the electrical perturbations. The maximal displacement is of 5 mm and it is converted by the transducer into a voltage variation of 20V such that: $U = \beta h$, where $\beta = 4000V/m$ and h is the displacement.

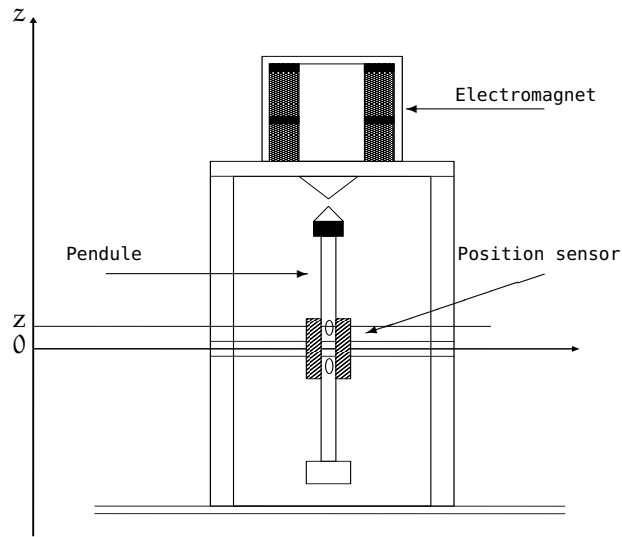

Figure 7.1: Magnetic suspension plant

To elaborate the control law, it is required to measure the position, speed of the pendulum and current. The experimental plant offers only the measurement of the position, thereby numerical estimators are necessary.

7.2 MATHEMATICAL MODEL

The actuator dynamic is described by a first order differential equation, where it is supposed that the inductance L is constant:

$$v(t) = L \frac{di(t)}{dt} + Ri(t) \quad (7.1)$$

$K_v = 1/R$, $\tau = L/R$ are experimentally determined. The force applied to the magnet is described by relation:

$$F_m(t) = c \frac{i^2(t)}{x^2(t)} \quad (7.2)$$

where x is the distance between the electromagnet and the pendulum and it is equal to : $x = x_0 - x_1$, with x_0 a constant given by the initial off-set and by the length of the pendulum. The variable x_1 is the pendulum position. The variable c can be determined by using equation (7.2) at the equilibrium point. The dynamics of the pendulum satisfies, according to the Newton second law, the relation:

$$m\ddot{x}_1(t) = F_m(t) - mg. \quad (7.3)$$

Denoting by $x_2 = \dot{x}_1$ the speed and by $x_3 = i$ the current, the previous equations are rearranged to get the state representation of the experimental plant and the system's output

$$\begin{cases} \dot{x}_1(t) = x_2(t) \\ \dot{x}_2(t) = \frac{c}{m} \frac{x_3^2(t)}{(x_0 - x_1(t))^2} - g \\ \dot{x}_3(t) = \frac{K_v v - x_3(t)}{\tau} \end{cases} \quad (7.4)$$

$$y(t) = \beta x_1(t). \quad (7.5)$$

The numerical values of the plant parameters are given in the next Table:

m	0.084 Kg	c	$5.2 \cdot 10^{-4} \frac{\text{Nm}^2}{\text{A}^2}$
K_v	0.1	τ	0.001 s
β	$4000 \frac{\text{V}}{\text{m}}$	x_0	0.011 m

Table 7.1: Numerical values of the plant parameters

The initial values for the state variables are $x_i = (0, 0, \sqrt{\frac{mg}{c}} x_0)$.

7.3 CONTROL LAW DESIGN

For the control design, the results detailed in [Chapter 4](#) are used here for the magnetic suspension plant. At first a continuous-time control is developed and its digital version is derived and computed.

The plant dynamics is nonlinear with relative degree 2. In this case an approach by using the backstepping design is a natural choice and also gives the tools for analyzing the stability properties. The digital version design provides a better implementation under the sampling of the continuous-time control, in terms of preserving the stability properties to larger sampling periods with the same performances.

To design the control law we used a simplified model of the plant with 2 state variables. By using the state representation from (7.4) and considering that the current is constant so that $x_3 = K_v v$.

7.3.1 Continuous-time backstepping design

The dynamics used to design the backstepping control is 7.6.

$$\begin{aligned}\dot{x}_1(t) &= x_2(t) \\ \dot{x}_2(t) &= \frac{c \cdot K_v^2}{m} \frac{v^2}{(x_0 - x_1(t))^2} - g\end{aligned}\quad (7.6)$$

The control objective is to stabilize the pendulum position x_1 to a specific point x_{ref} given by an external reference. The values of x_{ref} are within the range of $[-10/\beta, 10/\beta]$. In order to set the problem as in chapter 4, a change of coordinates is required. By setting $z = x_1 - x_{ref}$ (tracking error), then the system (7.6) rewrites:

$$\dot{z}(t) = \xi(t) \quad (7.7)$$

$$\dot{\xi}(t) = \frac{c \cdot K_v^2}{m} \frac{u}{(x_0 - x_{ref} - z(t))^2} - g \quad (7.8)$$

where the control u takes place for v^2 . In this way, the backstepping design can be easily applied for computing u , with the convention that for the plant the control $v = \sqrt{|u|} \text{sign}(u)$ is applied. The condition of the existence of $u_c(t)$ is that

$$g_a(z, \xi) = \frac{c \cdot K_v^2}{m(x_0 - x_{ref} - z)^2}$$

be invertible. This condition is verified since the denominator $(x_0 - x_{ref} - z)$ has a strict positive range $[0.0085 - z, 0.0135 - z]$, where $z \in [0, 0.005]$.

The Lyapunov function of the dynamic (7.7) that is positive and satisfies the condition

$$\frac{\partial W}{\partial z} (f(z) + g(z)\phi(z)) < 0 \quad (7.9)$$

is given by:

$$W(z) = \frac{1}{2} z^2. \quad (7.10)$$

By setting the fictitious control,

$$\phi(z) = -K_\phi z \quad (7.11)$$

with K_ϕ positive real. Then, the complete Lyapunov function for the system (7.7)-(7.8)

$$V(z, \xi) = \frac{1}{2} z^2 + \frac{1}{2} (\xi + K_\phi z)^2 \quad (7.12)$$

The continuous-time control law that asymptotically stabilizes the origin of the system (7.7)-(7.8) is

$$u_c(z, \xi) = \frac{m}{K_v^2 c} (x_0 - x_{ref} - z)^2 (g - (K_\phi + K_y)\xi - (K_\phi K_y + 1)z) \quad (7.13)$$

with $K_y > 0$. In the original x_1, x_2 coordinates one gets

$$u_c(x_1, x_2) = \frac{m}{K_v^2 c} (x_0 - x_1)^2 \left(g - (K_\phi + K_y)x_2 + \frac{(K_\phi K_y + 1)}{\beta} \epsilon \right) \quad (7.14)$$

For the plant experiment $K_\phi = 40$ and $K_y = 300$ are chosen according to the performance imposed on the speed and overshoot of the output. ϵ represents the output tracking error and it is equal to $r_{ref} - \beta x_1$. The external reference x_{ref} is kept constant. Due to the amplitudes of K_ϕ, K_y , for the simplicity of the next computations, the approximation $(K_\phi K_y + 1) \cong K_\phi K_y$ is used.

7.3.2 Sampled-data backstepping design

The second order approximate control has the form

$$u_k = u_{d0} + \frac{\delta}{2} u_{d1} + \frac{\delta^2}{6} u_{d2}$$

and the first control terms are given according to relations (4.44)-(4.46) by

$$\begin{aligned} u_{d0} &= u_c|_{t=k\delta} \\ u_{d1} &= -\frac{m}{cK_v^2} (x_0 - x_1) \left(2x_2(g + \dot{x}_2) + \right. \\ &\quad \left. (x_0 - x_1)(K_\phi K_y x_2 + (K_\phi + K_y)\dot{x}_2) \right)|_{t=k\delta} \\ u_{d2} &= \left(-\frac{u_{d1}}{x_0 - x_1} x_2 - \frac{m}{cK_v^2} (x_0 - x_1) \left(2\dot{x}_2(g + \dot{x}_2) + 2x_2\ddot{x}_2 - \right. \right. \\ &\quad \left. \left. - x_2(K_\phi K_y x_2 + (K_\phi + K_y)\dot{x}_2) + (x_0 - x_1)(K_\phi K_y \dot{x}_2 + \right. \right. \\ &\quad \left. \left. + (K_\phi + K_y)\ddot{x}_2) \right) + (K_\phi + \frac{\epsilon}{K_\phi \epsilon - \beta x_2} - \right. \\ &\quad \left. - \frac{2\xi}{(x_0 - x_1)} \frac{u_{d1}}{2} \right)|_{t=k\delta} \end{aligned} \quad (7.15)$$

where

$$\begin{aligned} \dot{x}_2 &= -(K_\phi + K_y)x_2 + \frac{K_\phi K_y}{\beta} (\epsilon) \\ \ddot{x}_2 &= -(K_\phi + K_y)\dot{x}_2 - K_\phi K_y x_2 \end{aligned}$$

7.3.3 Symbolic controllers

The polynomial expressions of the digital controller provided by **SimNLSys-BKS** are given next. The plant parameters have been replaced with the values specified in [Table 7.1](#). In the case of symbolic

expressions, the numbers are represented exactly, as fractions, and no truncation are performed. However, for presentation purposes only, the next expressions are truncated.

$$\begin{aligned} u_{d0}(x_1, x_2) = & \\ & 16100 (0.011 - x_{1k})^2 (0.00025 K_\phi K_y \epsilon_k - (K_\phi + K_y) x_{2k} + 9.8) \end{aligned} \quad (7.16)$$

$$\begin{aligned} u_{d1}(x_1, x_2) = & \\ & -32300 (0.0110 - x_{1k}) (0.00025 K_\phi K_y \epsilon_k - (K_\phi + K_y) x_{2k} + 9.8) x_{2k} + \\ & 16100 (0.011 - x_{1k})^2 (K_\phi - K_y) (-10^{-31} + 0.00025 K_\phi K_y \epsilon_k - \\ & (K_\phi + K_y) x_{2k}). \end{aligned} \quad (7.17)$$

$$\begin{aligned} u_{d2}(x_1, x_2) = & \\ & (32300 (0.00025 K_\phi K_y \epsilon_k - (K_\phi + K_y) x_{2k} + 9.8) x_{2k} - 32300 (0.011 - x_{1k}) \\ & (-K_\phi - K_y) (-10^{-31} + 0.00025 K_\phi K_y \epsilon_k - (K_\phi + K_y) x_{2k})) x_{2k} + \\ & (32300 (0.01 - x_{1k}) (K_\phi + K_y) x_{2k} - 32300 (0.01 - x_{1k}) (0.00025 K_\phi K_y \epsilon_k - \\ & (K_\phi + K_y) x_{2k} + 9.8) + 16100 (0.011 - x_{1k})^2 (-K_\phi - K_y) (-K_\phi - K_y)) \\ & (-10^{-31} + 0.00025 K_\phi K_y \epsilon_k - (K_\phi + K_y) x_{2k}) + 8060 (0.011 - x_{1k})^2 \\ & \left(\left(\frac{0.00248}{(0.0110 - x_{1k})^2} + 0.000124 \frac{x_{2k} + 40x_{1k}}{(0.011 - x_{1k})^3} \right) x_{2k} - \frac{0.000608}{(0.011 - x_{1k})^2} - \right. \\ & \left. 0.000062 \frac{80x_{2k} + 1600x_{1k} - 9.8}{(0.011 - x_{1k})^2} \right) (-32300 (0.011 - x_{1k}) (0.00025 K_\phi K_y \epsilon_k - \\ & (K_\phi + K_y) x_{2k} + 9.8) x_{2k} + 16100 (0.011 - x_{1k})^2 (-K_\phi - K_y) (-10^{-31} + \\ & 0.00025 K_\phi K_y \epsilon_k - (K_\phi + K_y) x_{2k})) (x_{2k} + 40 x_{1k})^{-1} \end{aligned} \quad (7.18)$$

It must be recalled that these expressions are evaluated at each sampling instant.

7.4 SIMULATION RESULTS

In the attempt to fix the suitable order the controller's approximation and the admissible sampling period, some simulations are preliminary. The next results, obtained by means of the SimNLSys software package, show the performances of the sampled-data control in comparison with the "ideal" continuous-time control. The sampled-data control is designed to preserve as much as possible the continuous time properties, in the present case the behavior of V at sampling instants. To evaluate the performance of the controls the error indicator (5.1) was used. For the next simulations, the initial state values are $x_{1_0} = 0.0025$ $x_{2_0} = 0$ and the gains $K_\phi = 40$ $K_y = 300$, same as the values used

for the experimental plant. In Figure 7.2 the control, the Lyapunov function and the matching error are illustrated for $\delta = 3\text{ms}$. One verifies that the digital controller which is closest to the continuous

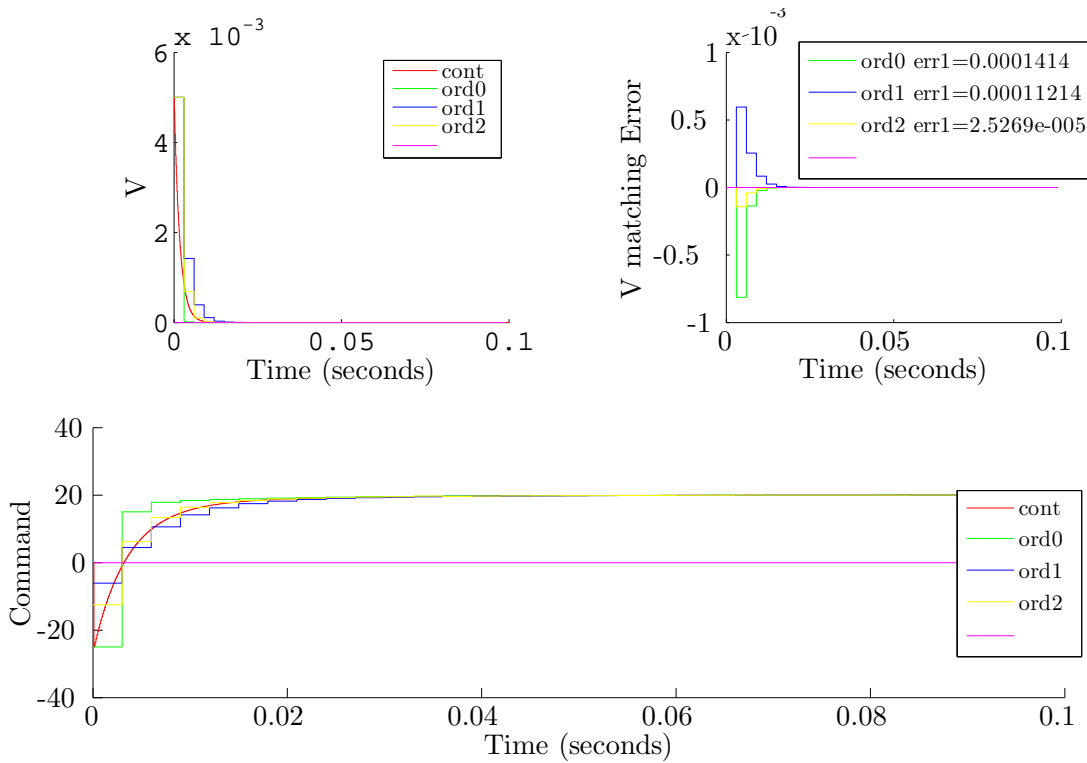

Figure 7.2: Control and V function evolutions for $\delta = 3\text{ ms}$ (simulation)

performances, is the second order controller. For this controller the matching error has the smallest value. At the opposite, the emulated control reveals the biggest error. Another remark is related to the initial command amplitude. For the emulated controller, the initial amplitude of the control is equal to the one obtained for a continuous-time controller, and for the higher order approximated controllers it is smaller. For practical reasons, this fact represents a benefit of higher order controllers in order to avoid the input saturation from the start.

In any way the errors given by $\delta = 3\text{ms}$ are sufficiently small, and all these controls can be used with success in practice.

In Figure 7.3 the case when $\delta = 5\text{ms}$ is represented. The emulated control begins to oscillate, but the worst results with respect to the Lyapunov matching are given by the first order command. The errors are bigger compared to the previous case.

In Figure 7.4 the results are obtained for a sampling period $\delta = 7\text{ms}$, above which the controllers fail to find the equilibrium point. For this situation, the second order controller is the only one that can stabilize the system, but it also has an oscillating form.

As a conclusion, for a given set of K_ϕ, K_y and for different values of δ :

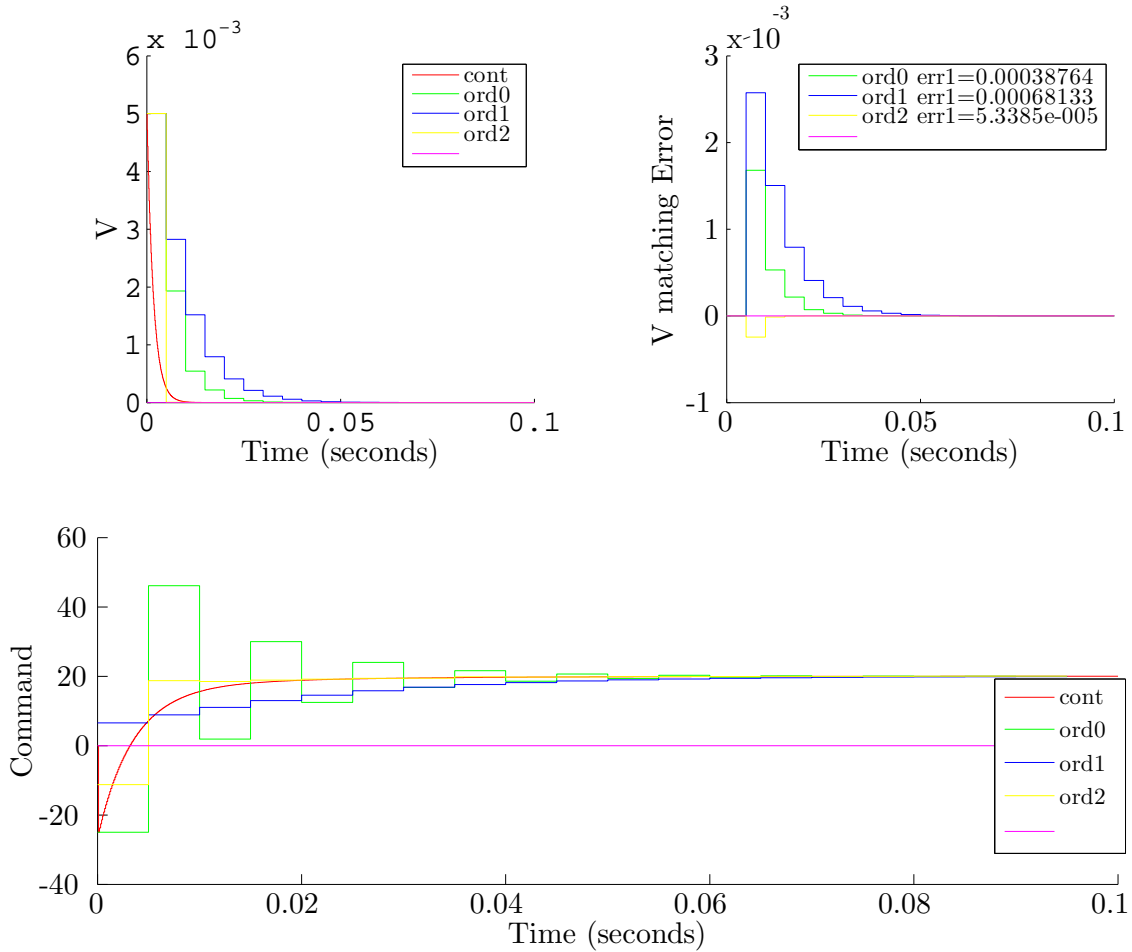

Figure 7.3: Control and V function evolutions for $\delta = 5$ ms (simulation)

- the second order controller performs better for all cases;
- the increasing of δ will increase the error magnitude.

In order to extend the results, in the next step it was considered the change of the controller gains. In Figure 7.5 there are shown the matching errors on the Lyapunov evolution for all three digital controls: emulated, first and second order sampled-data controllers. The error is represented in terms of gain K and sampling period δ . The parameter K was chosen such that $K_\phi = K$ and $K_y = K + 260$ and the effect is to accelerate the system response when it increases. For representation purposes only, the error criteria has been adapted as $err = E_0 + \ln(E)$, where E_0 is an offset additive term. The white zone represents the area where the error is higher than a threshold value, here set equal to 17.

Some comments are necessary. As we can observe, for some values of δ and K , the emulated control works well, and higher order sampled-data controls are not needed. For higher values of K and δ the first and the second order control are performing better than the emulated solution. In this case, if the sampling period is set to 7 ms, one notes higher errors (even instability) with the emulated and first

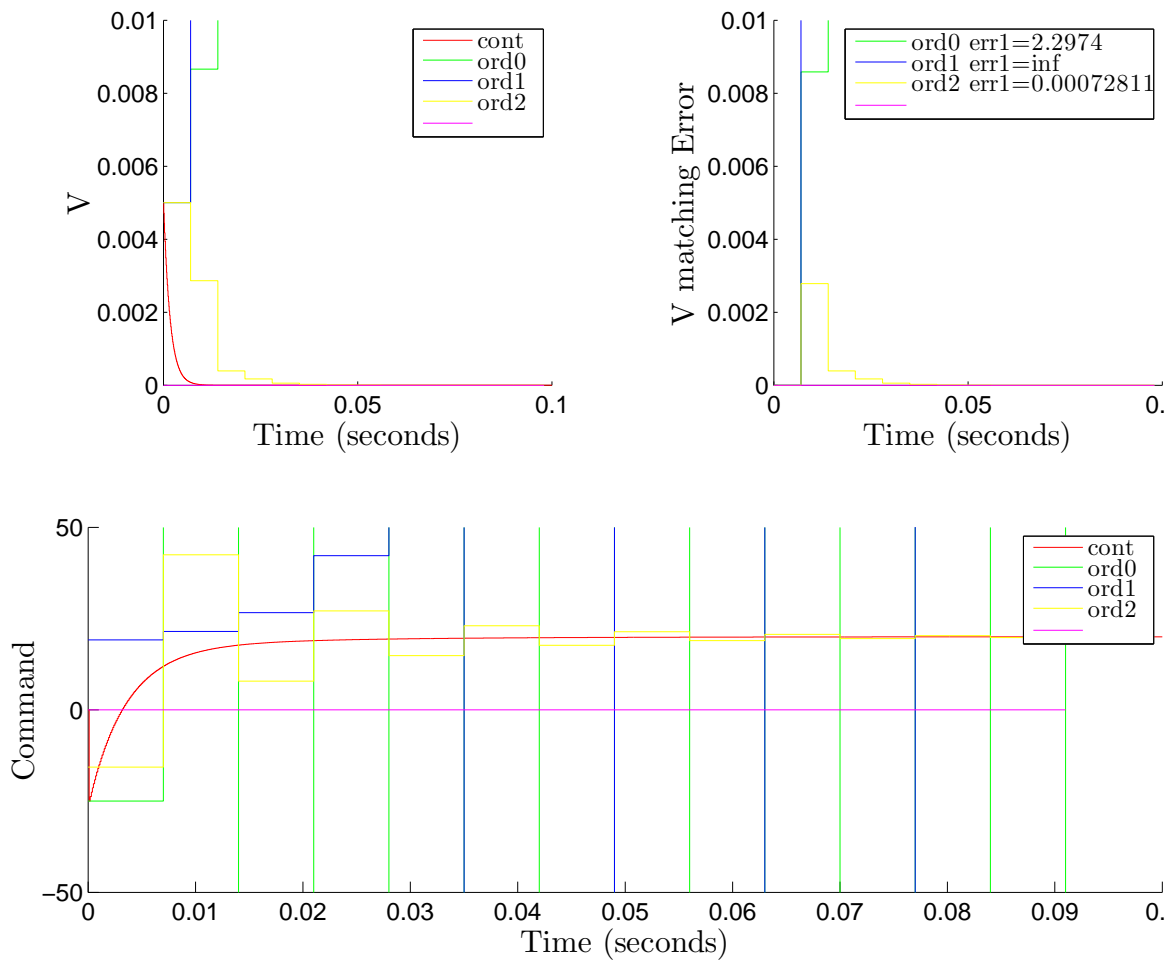

Figure 7.4: Control and V function evolutions for $\delta = 7$ ms (simulation)

order solution, while the control with two corrective terms notably extends the admissible length δ . Another set of conclusion that can be added

- increasing the gain K , makes the system to respond faster and the maximal admissible value for δ is reducing;
- for a fixed value of the gain, the matching error is reduced when using higher order digital controllers.

It is difficult to quantify the maximal admissible values of δ for a given sampled-data control, but the solution to this problem is the use of simulations tests (proposed by **SimNLSys**) to depict admissible ranges.

7.5 EXPERIMENTAL RESULTS

The Simulink control module is presented in Figure 7.6. There are some aspects that need to be explained. In order to implement the control laws specified by the equations (7.16)-(7.18) it is necessary

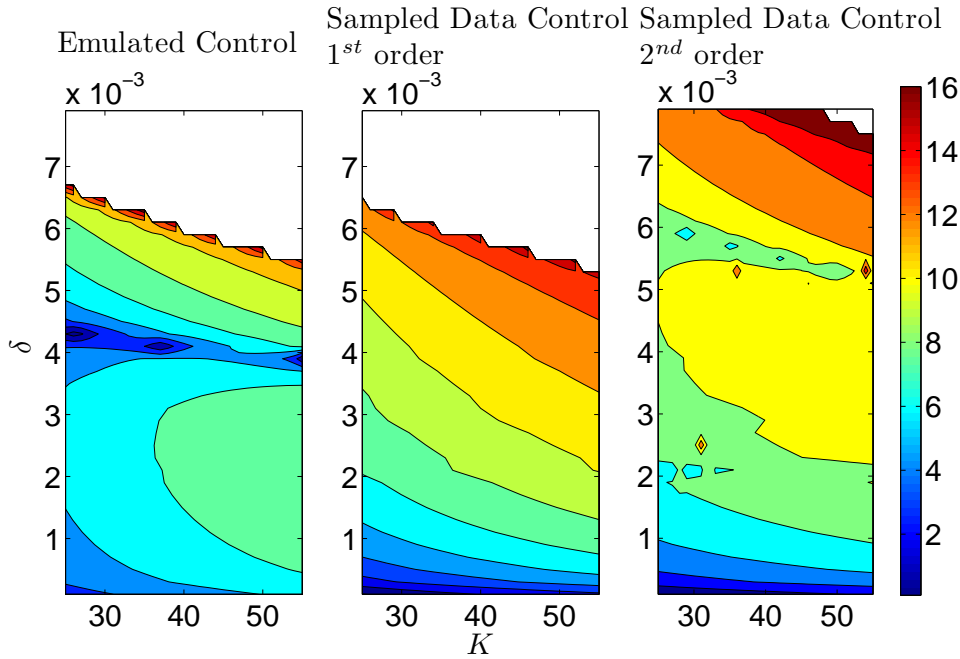

Figure 7.5: Lyapunov matching error under sampled-data control (simulation)

to estimate the state values. In the control scheme, a numerical observer is added. The state x_1 represents the pendulum position, and it is obtained from the system output $y = \beta x_1$. The state x_2 is the speed of the pendulum and it is obtained by using a numerical derivative of the system output. The x_3 state is the induced current and it is obtained from the control expression. The x_3 variable is not used in the control law computation but it is used in our estimations.

Another element used in the scheme in a parallel structure with the backstepping control module is a discrete-time integrator to compensate for the output steady state error.

The data is transferred to the experimental plant through the National Instruments acquisition card (PCI 6024E). The reference is given externally by a signal source as digital waveform with 0.5 Hz frequency. The hardware implementation works well beginning with a sampling period higher than 1 ms.

The control laws used are the ones specified in the previous sections recalling the applied control is $v = \sqrt{|u|} \text{sign}(u)$. Also a saturation block is considered in order to restrict the control input in compliance with the physical limits.

The value of the usual sampling rate is 3 ms. For the next results we used different values of the sampling period up to 7 ms. In Figures 7.7-7.9 the control, output and Lyapunov evolutions are depicted for three different sampling periods.

Comments 1. From figure 7.7 when $\delta = 3$ ms, it results that the emulated control performs best. The output evolution is stable and the overshoot is the smallest for the emulated case. But the emu-

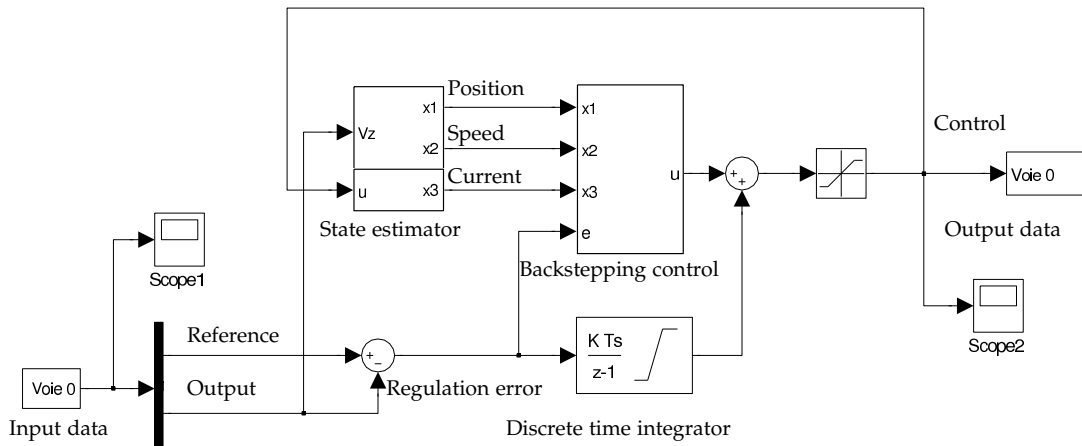

Figure 7.6: Simulink control module

lated control causes bigger overshoots in the system’s output. We can, also, observe the evolution of the Lyapunov function where the first order control offers bigger amplitudes, which means that the derivative of V will have, in this case, an increased negativity.

2. Increasing δ and as expected the performances are reduced. In Figure 7.8 there are shown the results obtained for $\delta = 6\text{ms}$. The first order controller is not working, and the emulated controller begins to oscillate. In this case the best control, from the Lyapunov matching viewpoint, is the second order one.

3. The maximum value used for δ was 7ms , and the results obtained are depicted in figure 7.9. For this case the only control that works is the second order one. The emulated and the first order controls are not able to stabilize the plant.

4. The experimental values confirm the results obtained in the simulation section. For example the maximum admissible values for the sampling rate are recovered with a slight difference. This is because of the model uncertainties and of the use of an approximate mathematical model in the simulation mode.

δ (ms)	Emulated Control (s)	1 st order control (s)	2 nd order control (s)
3	0.336	0.180	0.150
6	3.876	-	0.990
7	-	-	5.670

Table 7.2: Stabilizing Time

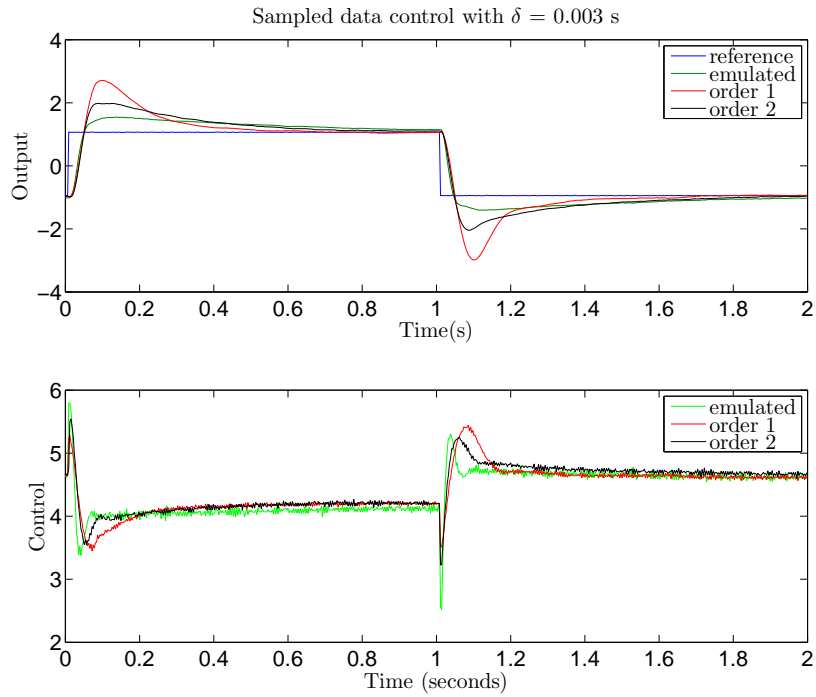

(a) Control and Output evolution

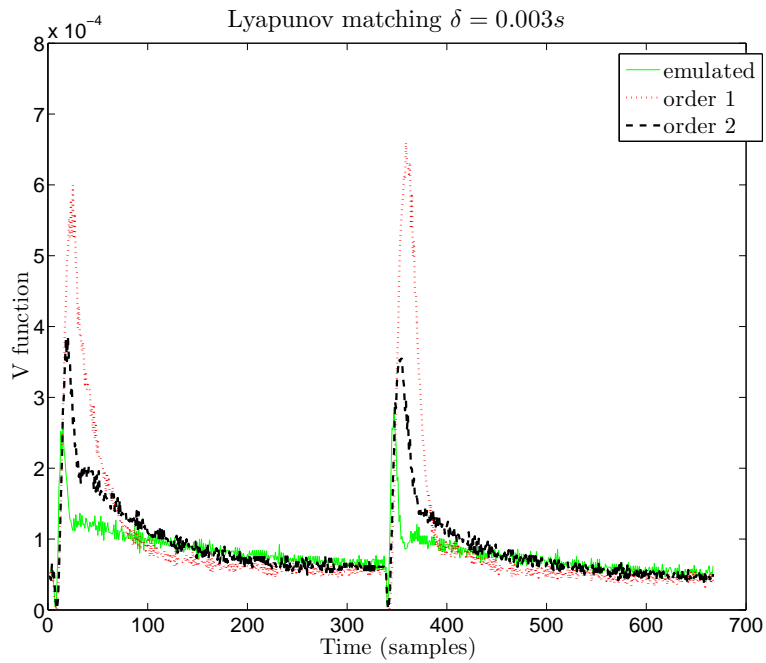

(b) Lyapunov function evolution

Figure 7.7: Control, output and Lyapunov for the experimental plant, $\delta = 3$ ms

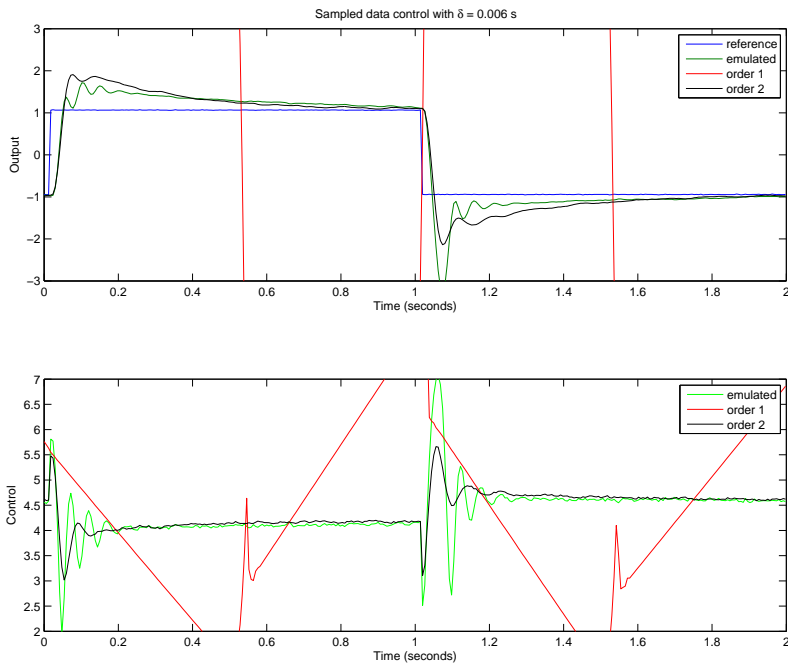

(a) Control and Output evolution

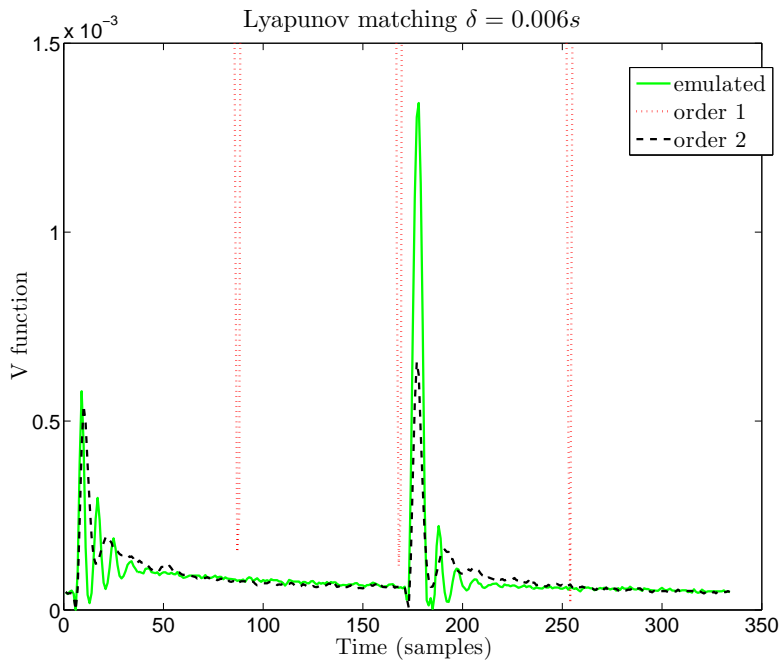

(b) Lyapunov function evolution

Figure 7.8: Control, output and Lyapunov for the experimental plant, $\delta = 6$ ms

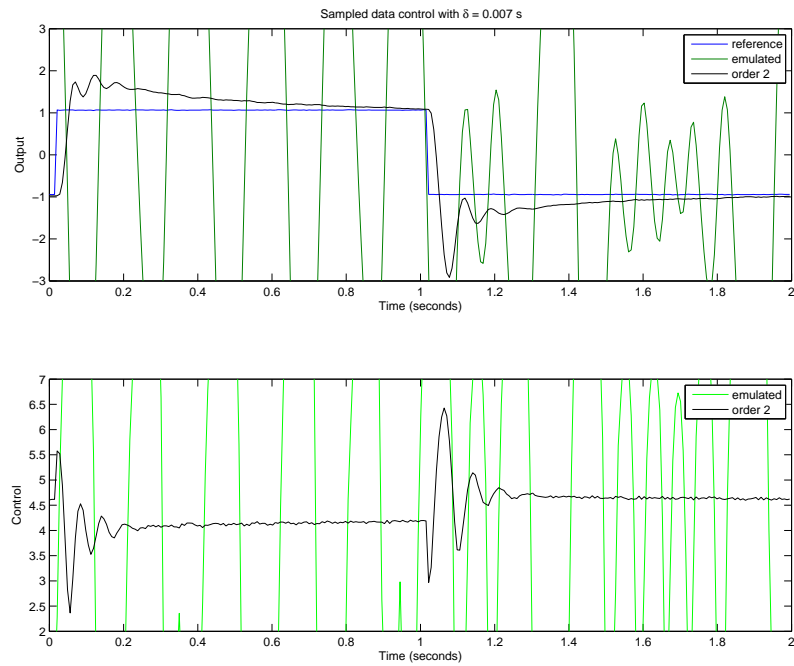

(a) Control and Output evolution

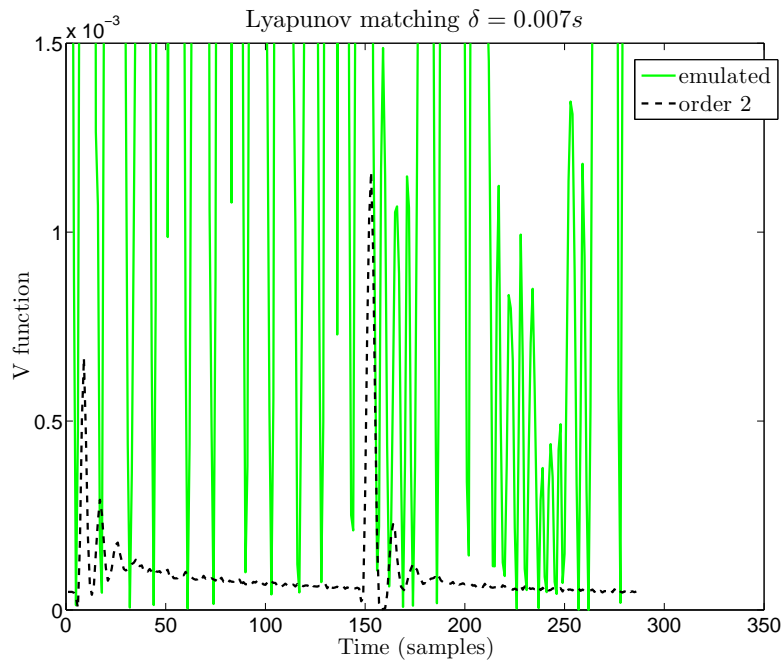

(b) Lyapunov function evolution

Figure 7.9: Control, output and Lyapunov for the experimental plant, $\delta = 7\text{ms}$

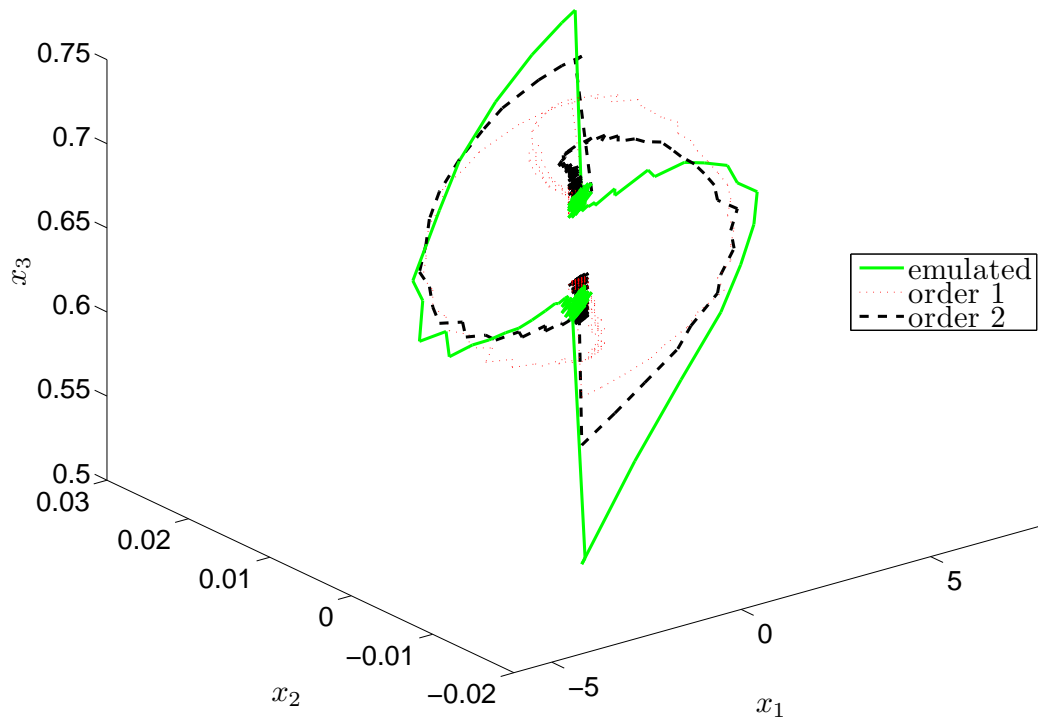

(a) Reduced time trajectories

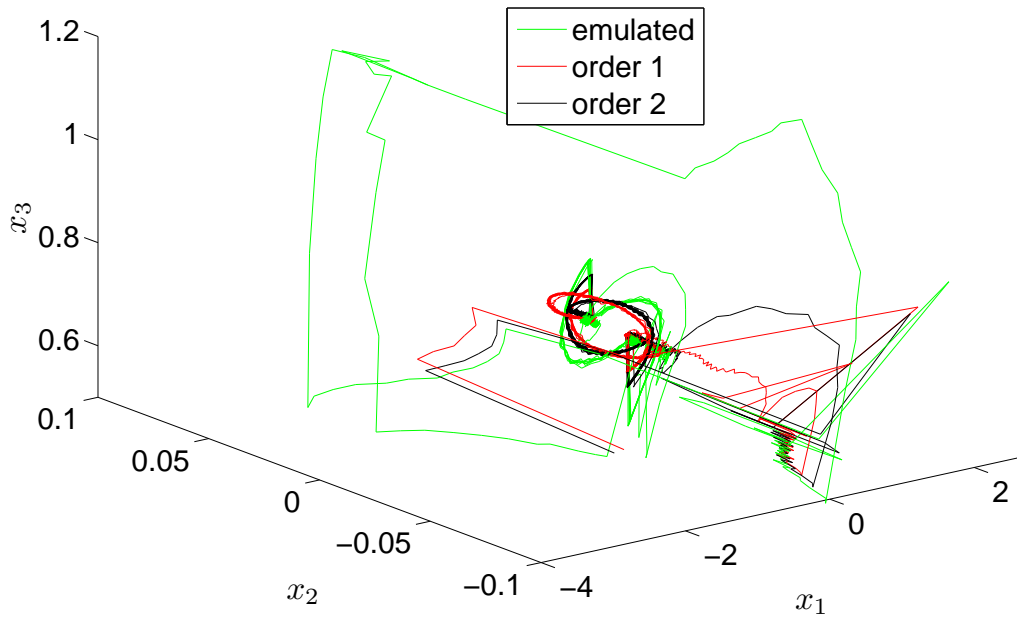

(b) Full time trajectories

Figure 7.10: Trajectories evolutions for the experimental plant, $\delta = 3\text{ms}$

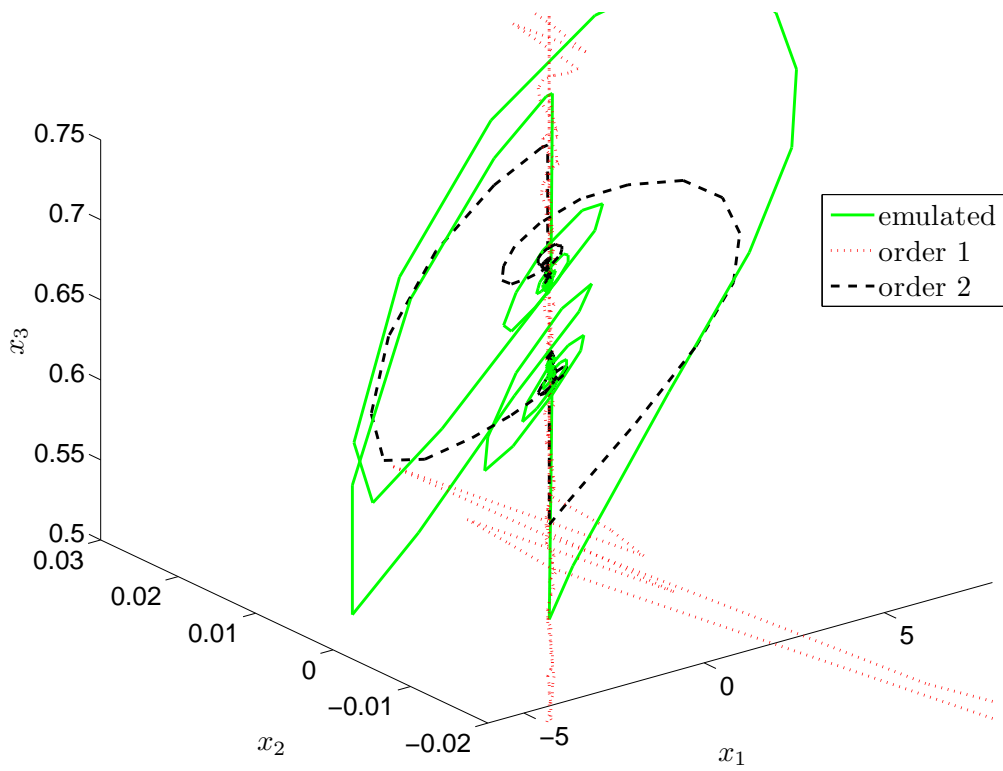

(a) Reduced time trajectories

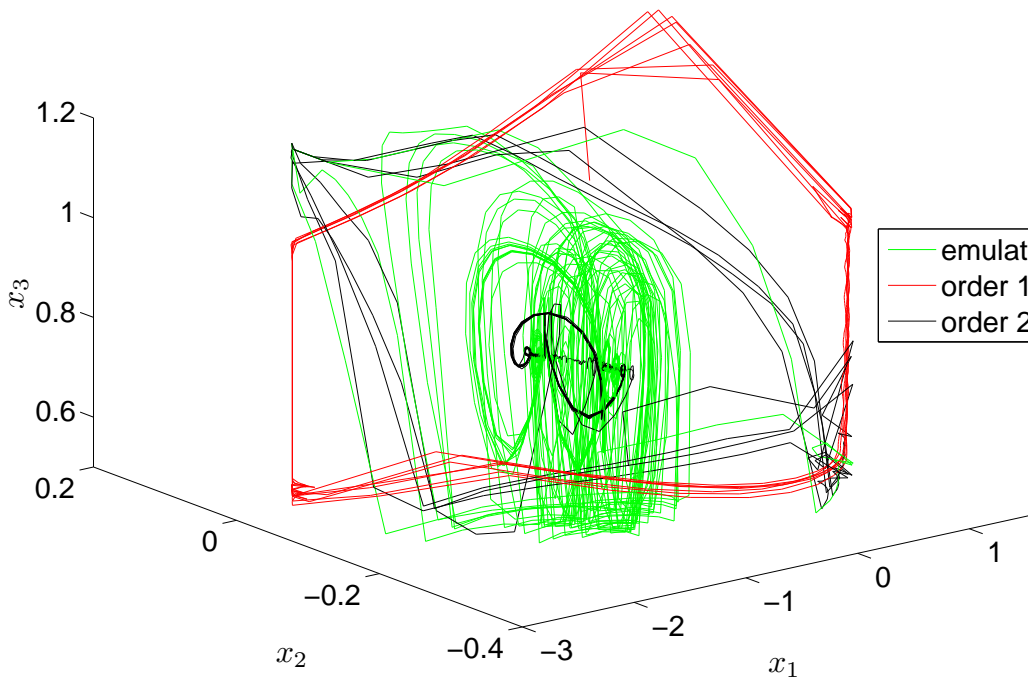

(b) Full time trajectories

Figure 7.11: Trajectories evolutions for the experimental plant, $\delta = 6\text{ms}$

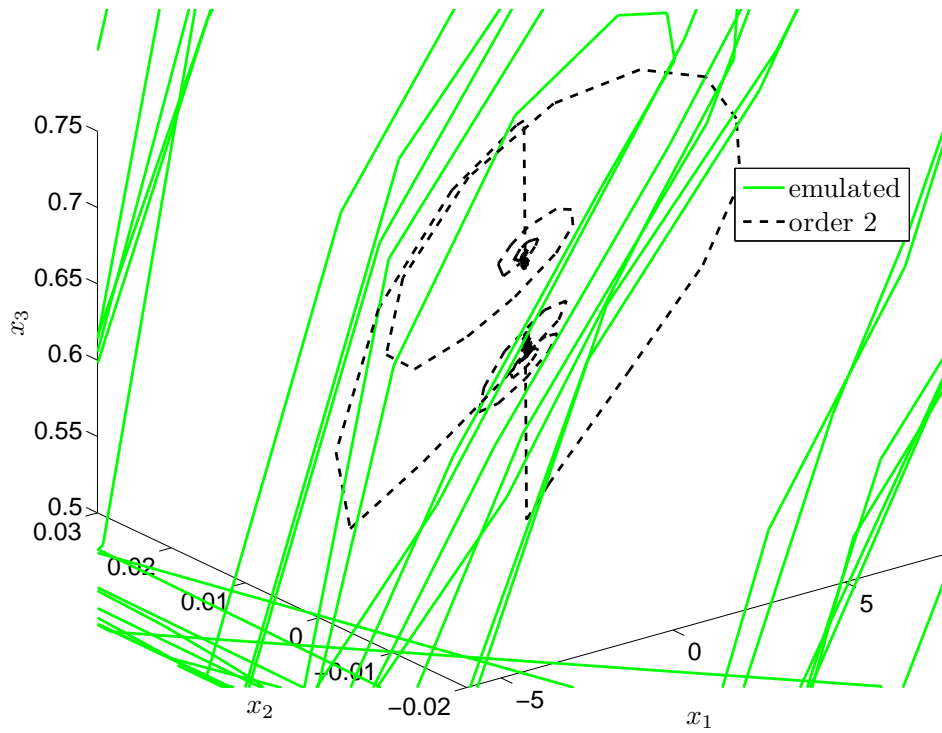

(a) Reduced time trajectories

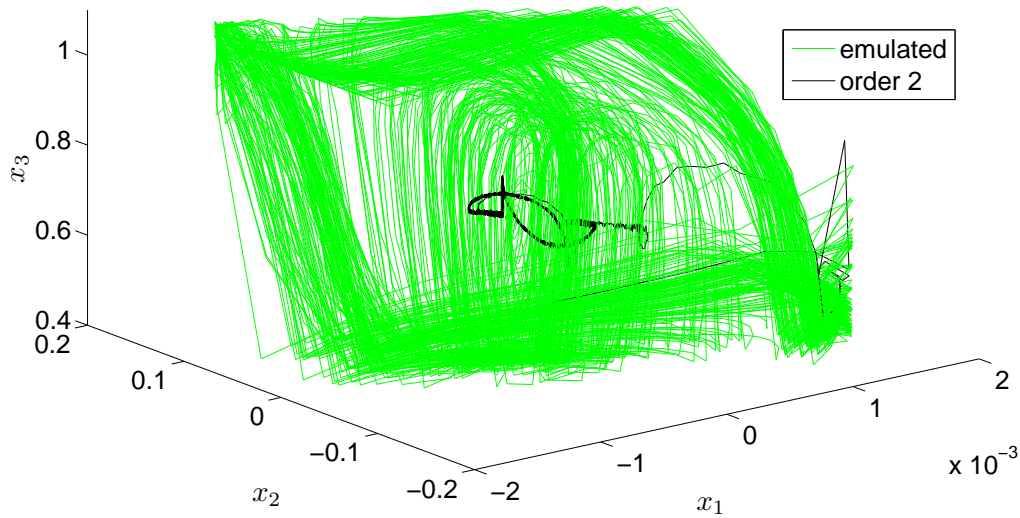

(b) Full time trajectories

Figure 7.12: Trajectories evolutions for the experimental plant, $\delta = 7\text{ms}$

Another interesting result that was obtained, is the time length necessary for the control to stabilize the system. This is the time which is necessary to bring the system from the initial point to a point on the stabilizing trajectory. We see an example in [Figure 7.13](#). In this example we observe that the second order control starts to stabilize after 5 seconds from the beginning of the experiment. In order to highlight the phenomena, 3D state trajectories were computed for each sampling period used ([Figures 7.10-7.12](#)). At the top, the trajectories for a fixed time-period (when the controllers were active) are shown. At the bottom, the same trajectories are plotted but for the full time of the experiment.

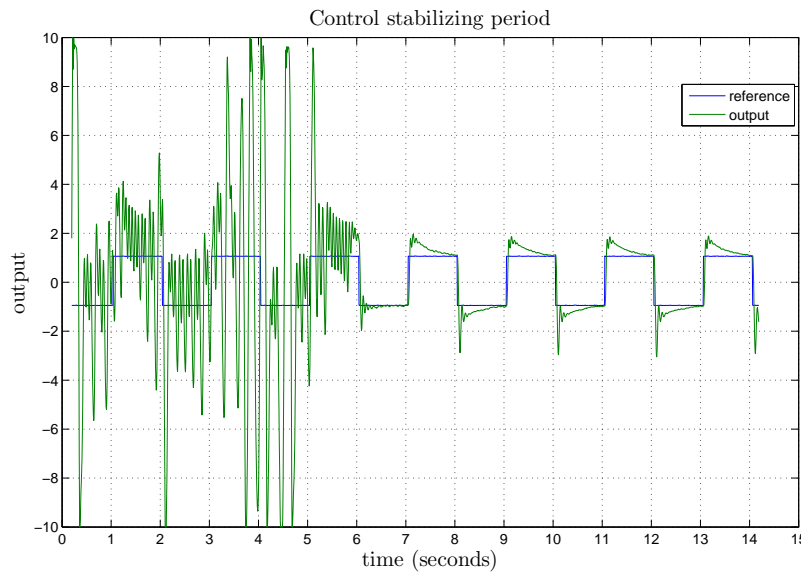

Figure 7.13: Example for 2nd order control with $\delta = 0.007s$

For example for $\delta = 3ms$, all the three controllers stabilize, and the second order offers the shortest path between the equilibrium points. If we look at the full time experiment, we can observe that the emulated control needs a longer path to find the stabilizing trajectories. The time periods the controls need to start to be active are summarized in [Table 7.2](#). For this case, the emulated controller needs 0,336 seconds. By using a controller of higher orders this time is significantly reduced.

When $\delta = 6ms$, the emulated and the second order controls are both stabilizing, but the emulated control needs a longer time. In the same time, the control with one order approximation fails to find the stabilizing trajectory, and it is constrained to a limit cycle.

For $\delta = 7ms$, the second order controller finds the stabilizing trajectory, but the emulated control fails.

In [Table 7.2](#) we summarize the time periods for stabilizing the plant. It is interesting to discuss the improvement of the sampled-data design with respect to the transient time periods which represent the time delay for the control to be active.

NONLINEAR COUPLED-TANK - LEVEL CONTROL

The object of this case study is to highlight, on a physical coupled tanks system, the performance of a digital implementation of a continuous-time passivity based controller. The design considers the sampled-data model of the plant and provides better results compared with the emulations of a given continuous-time controller. A two-state continuous-time nonlinear model is known and used to develop both the continuous-time and digital controllers. The results show good performance of the digital controller when increasing the sampling period or the controllers' gain. The results reported here are included in the paper [C05] from the author's contribution list (page ix).

8.1 THE LEVEL CONTROL PROBLEM

Levels regulation is a basic problem with vast and different applications in process industries. Many applications can be met in the case of steam generators, petrochemical plants, storage tanks in gas/oil production industry, paper making and water industries and many others. In these applications, the liquid is pumped, stored in tanks and then pumped into another tank. The control of the fluid level is always mandatory and could be critical (e.g. the main reason for plant shut-downs in nuclear or conventional power plants [Eborn *et al.* 1999]). Furthermore, depending on the particular applications, the inlet or outlet flows should be also controlled. This fact can be important in the case of cascade of tanks since the first tank outlet flow overshoots can be amplified as it flows down the cascade [Sbarbaro & Ortega 2005].

Various experimental plants were used for testing and designing control strategies such as: coupled tank systems, cascade tanks, three-tank systems [Iplikci 2010], conical tanks [Bhuvaneswari *et al.* 2009], quadruple-tank process [Johansson 2000], state-coupled tanks [Pan *et al.* 2005] and so on. Related to the control strategies used, the majority deals with the design of linear controllers. Among these, the PID control is proved to be the most used with satisfactory performance. As the system is in

fact non-linear many linear strategies have been adapted to handle this situation. In this way many algorithms are still based on PID control where the controller parameters have to be continuously adjusted (e.g. [Iplikci 2010]) by using different strategies. Other strategies involve predictive, optimal and adaptive control [Bhuvanewari *et al.* 2009]. Intelligent control involving fuzzy control, neural network control and genetic algorithms have been also developed for level tanks systems (see references in [Almutairi & Zribi 2006]).

In the context of the exact knowledge of the nonlinear model, only fewer nonlinear control strategies have been implemented, as from our knowledge : sliding mode control [Almutairi & Zribi 2006], [Perruquetti & Barbot 2002], backstepping control [Pan *et al.* 2005], passivity based control [Sbarbaro & Ortega 2005], [Kottenstette *et al.* 2010].

In this case study a passivity based control strategy is used. The passivity concept (firstly introduced by Popov [Popov 1973]) has generated many useful tools in designing a robust controller in a nonlinear context. Today, this approach is very attractive due to its wide range of applicability in the nonlinear control area.

The sampled-data solution that is here developed, was evaluated on a tank level system available at University Politehnica of Bucharest. The solution proposed here is inspired from [Monaco & Normand-Cyrot 2007] and [Monaco *et al.* 2011]. According to this approach, the controller design is carried out in a continuous-time domain and then a digital controller is computed in order to reproduce a specific continuous-time property of the closed loop, at each sampling instant. In this case we are referring to reproducing the passivity property assured by the continuous-time controller. It is a known fact that the passivity is destroyed under sampling [Monaco *et al.* 2011]. This controller has proved to better preserve the passivity property with respect to the emulated solution and thus the stabilizing or damping performance.

8.2 UNDERLYING THEORY

8.2.1 *Passivity based control*

Passive systems are a class of processes that dissipate certain types of physical or virtual energy, described by Lyapunov-like functions [Ortega *et al.* 1998], [Bao & Lee 2007]. The concept is defined as an input output property of a process and it is particularly useful in the analysis of stability. Furthermore, the passivity concept allows us to construct robust control laws even for nonlinear

process. It is shown for instance in [Sepulchre *et al.* 1997] if a feedback controller is designed to add to the system an “excess of passivity”, it can handle important uncertainties of the system parameters.

In the following lines, we recall from [Monaco *et al.* 2010], the main definitions and results that are necessary to design the continuous-time controller in section 8.3.3. Let us consider the input-affine system

$$\begin{aligned}\dot{x}(t) &= f(x(t)) + u_c(t)g(x(t)) \\ y(t) &= h(x(t))\end{aligned}\tag{8.1}$$

P1 - Passivity An input-affine system (8.1) is passive if there exists a positive C^1 function V on \mathbb{R}^n (the storage function) such that $V(0) = 0$ and for all $u \in \mathcal{U}$, $t \geq 0$

$$\dot{V}(x(t)) \leq y^T(t)u(t)\tag{8.2}$$

or its integral equivalent for all $x_0 \in \mathbb{R}^n$

$$V(x(t)) - V(x_0) \leq \int_0^t y^T(\tau)u(\tau)d\tau\tag{8.3}$$

where \mathcal{U} is a set in \mathbb{R} of admissible inputs.

Equivalent definitions state that a system is passive if it is *dissipative* with bilinear supply rate $w(u, y) = y^T u$ [Sepulchre *et al.* 1997]. The interpretation is that the rate of increase of energy is not bigger than the input power.

P2 - zero-state detectability (ZSD) The system (8.1) is locally zero state detectable if no solution of the uncontrolled dynamics $\dot{x} = f(x)$ can stay in the set $Z = \{x \in \mathbb{R}^n, \text{ s.t. } h(x) = 0\}$ other than solutions $x(t)$ converging asymptotically to the zero equilibrium.

The main benefit of the ZSD property is that it gives the condition to connect the stability with passivity. There follows the next result.

P3- negative output feedback gain Under the assumption *P1*, with $V > 0$ and zero-state detectability, then the storage function V qualifies as a Lyapunov function and the controller $u_c(t) = -Ky(t)$ with $K > 0$ asymptotically stabilizes the initial system. Under these conditions, the closed loop dynamics satisfies

$$\dot{V}(t) \leq -Ky^2(t).\tag{8.4}$$

With the increase of the gain K , more negativity is added to \dot{V} compared to the free evolution and thus improving the damping performance.

In conclusion, if we look to stabilize the system (8.1), it becomes a simple task if this system with input u and output y is passive. The property *P3* tell us that we can close the loop with $u = -Ky$, and if the system is ZSD, the equilibrium point is GAS. As a consequence, the system has to be stable

also when $u = 0$. If this condition is not satisfied, then it is necessary to make the following feedback transformation

$$u_c = \alpha(x(t)) + \beta(x(t))v(t, x(t)), \quad (8.5)$$

with $\beta(\cdot)$ invertible, such that the new system is passive. If this feedback can be found to render the system passive, then the original system (8.1) is called *feedback passive*.

Theorem 50. [Sepulchre et al. 1997] Assume that $\frac{\partial h}{\partial x}(0)$ has full rank. Then the system (8.1) is feedback passive with a C^2 positive definite storage function $S(x)$ if and only if it has relative degree one at $x = 0$ and is weakly minimum phase¹.

The feedback transformation (8.5) render the closed loop system passive, and furthermore by taking $v = -Ky$, then under the ZSD assumption the equilibrium point is asymptotically stable.

8.2.2 Digital design

In this section, we recall the steps for the digital design of a PBC controller in the context of preserving under sampling, the stabilizing properties of the continuous-time plant.

Under sampling, the passivity condition (8.3) is rewritten as follows, by assuming $u(t) = u_k$ for $t \in [k\delta, (k+1)\delta)$, with δ the sampling period:

$$V(x_{k+1}) - V(x_k) \leq u_k \int_{k\delta}^{(k+1)\delta} y(\tau) d\tau \quad (8.6)$$

The left side represents the Lyapunov difference of the sampled-data plant for a time period equal to δ .

The basic idea for designing a digital controller u_k is that it has to satisfy the inequality (8.6) for various δ . In this context, two direct digital strategies were proposed in [Monaco et al. 2010], one that renders negative the right hand side (negative sampled-data predictive output feedback) and the other one the left hand side ($L_{G\delta}$ controller) negative of the inequality (8.6). These approaches do not rely on the controller design that was carried out in continuous-time, and allow to specify the performance of the sampled-data controller in discrete-time.

Another solution, that can be applied, relies on the *the input-Lyapunov matching* strategy, which aim is to design a piecewise constant controller that ensures the matching of the sampled data Lyapunov evolution with the continuous-time one at each sampling instant. This procedure is presented in Chapter 3 where the algorithm for computing the controller expressions is given.

¹ A system is *weakly minimum phase* if it is Lyapunov stable and there exists a C^2 positive definite function $W(z)$ such that $L_{f_{zd}} W \leq 0$ in a neighborhood of $z = 0$, with f_{zd} the vector field of the zero dynamics system. More details can be found in [Isidori 1995]

8.3 THE EXPERIMENTAL PLANT MODEL AND CONTROLLER DESIGN

In this section there is provided a short description of the experimental plant and of the controllers design.

8.3.1 *The plant description*

The laboratory platform (ELWE Technick) used to test the proposed algorithms consists of 3 main water tanks and a water reservoir. The flows of the water is assured by means of 6 electro valves and 2 pumps and each liquid level is measured by one of the 3 piezoresistive transducers (VEGABAR 14).

In Figure 8.1 there is presented the scheme of a coupled-tank system that is configured on the laboratory platform. The water is pumped into tank T_1 and from there through a connection pipe (with a section area S_1) into tank T_2 . The water flows into the reservoir through an electro valve (fully open) with a section area S_2 . The values of the plant parameters are described next:

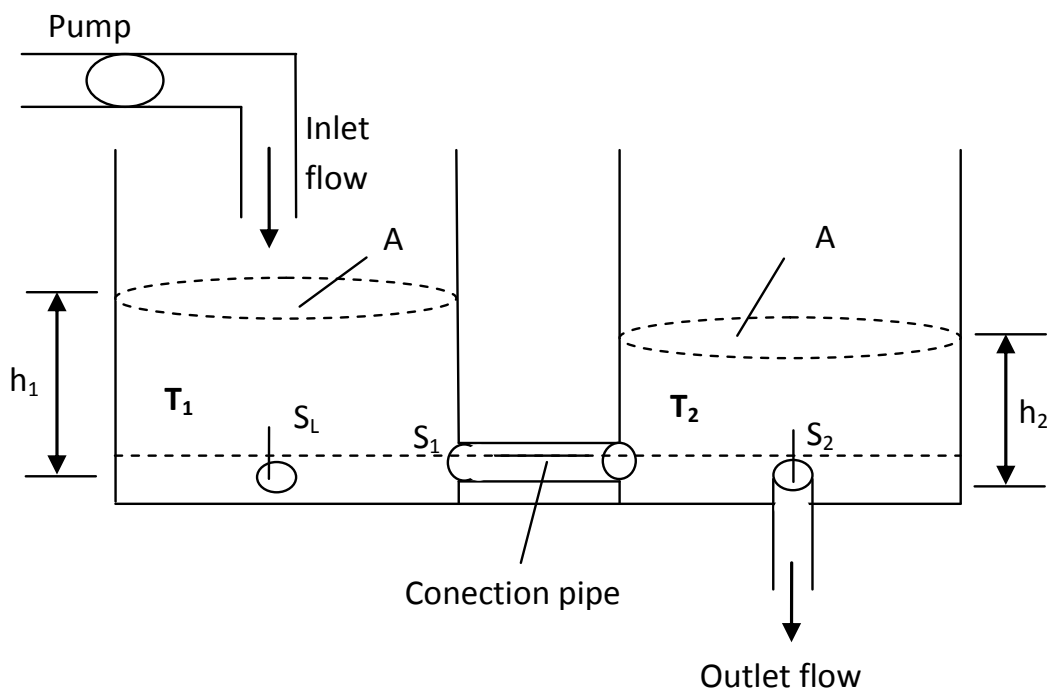

Figure 8.1: Schematic of coupled-tanks

- $A = 0.0154 \text{ m}^2$ - section area of each tank;
- $S_1 = S_2 = 5 \cdot 10^{-5} \text{ m}^2$ - the section area of each pipe corresponding to the electro valves;
- $Q_0 = 10^{-4} \text{ m}^3/\text{s}$, $h_0 = 0.6 \text{ m}$ - the maximal values of the inlet flow and tank level respectively.

The connection of the plant with a PC is assured by 2 acquisition cards : "Humusoft MF624" for Pump 1 and level transducers and "National Instruments PCI-6503" which controls the electro valves. The real-time interface is configured in Simulink.

8.3.2 The dynamics

The dynamics Σ_c of the coupled tanks can be written as

$$\dot{h}_1 = \frac{1}{A} Q_i(t) - \frac{1}{A} c_1 \sqrt{|h_1 - h_2|} \text{sign}(h_1 - h_2) \quad (8.7)$$

$$\dot{h}_2 = \frac{1}{A} c_1 \sqrt{|h_1 - h_2|} \text{sign}(h_1 - h_2) - \frac{1}{A} c_2 \sqrt{h_2} \quad (8.8)$$

with $c_1 = 1.0121 \cdot 10^{-4}$, $c_2 = 1.6854 \cdot 10^{-4}$ experimentally determined. The input is the inlet volumetric flow rate $u(t) = Q_i(t)$, the state variables represents the liquid levels in tank T_1 and T_2 and the output is chosen equal to h_1 . In the case of coupled tanks, the inequality $h_1 \geq h_2$ holds, in every operating point.

Let us consider the storage function S as

$$S(t) = \frac{1}{2} A (h_1^2(t) + h_2^2(t)) \quad (8.9)$$

which represents half of the total energy stored in both tanks. Next proposition holds.

Proposition 51. *The system Σ_c defined by equations (8.7)-(8.8) with output $y = h_1$ and input variable $u(t) = Q_i(t)$ is passive.*

Proof. One computes

$$\begin{aligned} \dot{S}(t) &= A h_1(t) \dot{h}_1(t) + A h_2(t) \dot{h}_2(t) = \\ &= Q_i(t) h_1(t) - c_1 \sqrt{h_1(t) - h_2(t)} (h_1(t) - h_2(t)) - c_2 \sqrt{h_2(t)} h_2(t) \end{aligned} \quad (8.10)$$

with

$$y(t)u(t) = Q_i(t)h_1(t) \quad (8.11)$$

Passivity condition holds ($\frac{dS(t)}{dt} \leq y(t)u(t)$) i.e.

$$Q_i h_1 - c_1 \sqrt{h_1 - h_2} (h_1 - h_2) - c_2 \sqrt{h_2} h_2 \leq Q_i h_1 \quad (8.12)$$

since $\forall h_1 \geq h_2 \in \mathbb{R}_+$. □

At the equilibrium point, a useful relation can be found,

$$h_{1e} = \frac{c_1^2 + c_2^2}{c_1^2} h_{2e} = h_{2e}/d_e, \quad (8.13)$$

with $d_e \cong 0.265$.

8.3.3 Continuous-time controller design

The control objective is to maintain the levels of the coupled-tanks, to the desired values h_{1d} , h_{2d} given by an external reference.

The system (8.7)-(8.8) is passive and also satisfies the ZSD property (it can be easily shown that since $h_1(t) = 0$ and $Q_i(t) = 0$ the dynamics x is converging to 0). According to P3 property, the negative output controller $u(t) = -Ky(t)$ asymptotically stabilizes the origin of the system. This controller brings the system to the equilibrium $h_1 = 0$ and $h_2 = 0$.

To accomplish the level regulation to a nonzero value, a change of coordinates is required in order to construct an error dynamics model and a new storage function V .

Let us consider the following change of coordinates:

$$z_1 = \frac{h_1 - h_{1r}}{h_0}, \quad z_2 = \frac{h_2 - h_{2r}}{h_0}.$$

In this way, $z_1 \in [-d, 1-d]$ and $z_2 \in [-d_e d, d_e - d_e d]$ with $d = h_1/h_0$, $d \in [0, 1]$ and d_e previously defined. The controller transformation is considered as $u(t) = Q_0(u_s + v(t))$ and the error plant dynamics becomes:

$$\dot{z}_1 = \frac{1}{Ah_0} \left((u_s + v(t))Q_0 - c_1 \sqrt{h_0(z_1 - z_2) + h_{1r} - h_{2r}} \right) \quad (8.14)$$

$$\dot{z}_2 = \frac{1}{Ah_0} \left(c_1 \sqrt{h_0(z_1 - z_2) + h_{1r} - h_{2r}} - c_2 \sqrt{h_0 z_2 + h_{2r}} \right) \quad (8.15)$$

with external control $v(t)$ and now the output is chosen as $y = Q_0 z_1$. The u_s component of the controller is designed such that the equilibrium point of the error dynamics be $z_1 = 0$, $z_2 = 0$. In this point the dynamics are:

$$0 = \frac{1}{Ah_0} \left(u_s Q_0 - c_1 \sqrt{h_{1r} - h_{2r}} \right) \quad (8.16)$$

$$0 = \frac{1}{Ah_0} \left(c_1 \sqrt{h_{1r} - h_{2r}} - c_2 \sqrt{h_{2r}} \right) \quad (8.17)$$

and one gets

$$u_s Q_0 = c_1 \sqrt{h_{1r} - h_{2r}} = c_2 \sqrt{h_{2r}}.$$

Now let us give the following results.

Proposition 52. *The system dynamics (8.14)-(8.15) is feedback passive, and the control law $v(t) = -Ky(t)$ asymptotically stabilize the system in the origin.*

Proof. Let us consider the following storage function V :

$$V = \frac{1}{2} Ah_0 (z_1^2 + z_2^2). \quad (8.18)$$

The passivity condition (8.2) is translated to

$$\begin{aligned} z_1 Q_0(u_s + v(t)) - c_1 \sqrt{h_0(z_1 - z_2) + h_{1r} - h_{2r}}(z_1 - z_2) \\ - c_2 \sqrt{h_0 z_2 + h_{2r}} \leq Q_0 z_1 v(t) \end{aligned} \quad (8.19)$$

The upper condition is satisfied, since, after some computations

$$z_1 \sqrt{d(1 - d_e)} - \sqrt{z_1 - z_2 + d(1 - d_e)}(z_1 - z_2) - z_2 \sqrt{\frac{1}{d_e} - 1} \sqrt{z_2 + d_e d} \leq 0$$

holds for every $z_1 \in [-d, 1 - d]$, $z_2 \in [-d_e d, d_e - d_e d]$ and $d \in [0, 1]$, with $z_1 - z_2 + d(1 - d_e) \geq 0$.

When $v = 0$ and $y = Q_0 z_1 = 0$ the solution of the system is converging to 0, so the system is respecting the ZSD property. This can be also seen by the existence of 2 invariant manifolds $z_2 = 0$ and $z_1 - z_2 = 0$.

For the first manifold $z_2 = 0$ the dynamics become:

$$\dot{z}_1 = \frac{c_1}{A h_0} (\sqrt{h_{1r} - h_{2r}} - \sqrt{h_0 z_1 + h_{1r} - h_{2r}}) \quad (8.20)$$

and after some computations:

$$\dot{z}_1 = \frac{c_1}{A h_0} \frac{-h_0 z_1}{\sqrt{h_{1r} - h_{2r}} + \sqrt{h_0 z_1 + h_{1r} - h_{2r}}} \quad (8.21)$$

which shows that z_1 is also converging to 0.

For the second manifold $z_1 - z_2 = 0$ it results that

$$\dot{z}_2 = \frac{1}{A h_0} (c_1 \sqrt{h_{1r} - h_{2r}} - c_2 \sqrt{h_0 z_2 + h_{2r}}) \quad (8.22)$$

and after some computations:

$$\dot{z}_2 = \frac{c_2}{A h_0} \frac{-h_0 z_2}{\sqrt{h_{2r}} + \sqrt{h_0 z_2 + h_{2r}}} \quad (8.23)$$

which shows that z_2 and z_1 are converging to 0.

We conclude now, that the controller $v(t) = -Ky(t)$ asymptotically stabilizes the system to the equilibrium point $z_1 = z_2 = 0$, with $K > 0$. \square

Going back to the initial coordinates, the practical controller $u(t)$ is expressed as:

$$u(t) = c_1 \sqrt{h_{1r} - h_{2r}} - K Q_0 \frac{h_1(t) - h_{1r}}{h_0}, \quad K > 0.$$

The parameter K is chosen according to the admissible values of the overshoot and the speed of the systems output.

8.3.4 *Sampled-data controller design*

For the next developments let us consider the error dynamics written in a compact manner:

$$\dot{z}(t) = f(z(t)) + g(z(t))u_c(t) \quad (8.24)$$

with

$$f(z) = \frac{1}{Ah_0} \begin{bmatrix} u_s Q_0 - c_1 \sqrt{h_0(z_1 - z_2) + h_{1r} - h_{2r}} \\ c_1 \sqrt{h_0(z_1 - z_2) + h_{1r} - h_{2r}} - c_2 \sqrt{h_0 z_2 + h_{2r}} \end{bmatrix}$$

$$g(z) = \frac{Q_0}{Ah_0} \begin{bmatrix} 1 \\ 0 \end{bmatrix}, \quad u_c(t) = -Ky(t)$$

The second order digital controller, according to the design presented in section 8.2.2, has the next structure:

$$u_{da}^2 = u_{d0} + \frac{\delta}{2} u_{d1} + \frac{\delta^2}{6} u_{d2} \quad (8.25)$$

with controller terms according to (3.8)-(3.10):

$$u_{d0} = -Kz_1|_{t=k\delta}$$

$$u_{d1} = \frac{Kc_1(\sqrt{h_{1r} - h_{2r} + h_0(z_1 - z_2)} - \sqrt{h_{1r} - h_{2r}}) + K^2 Q_0 z_1|_{t=k\delta}}{Ah_0}$$

$$u_{d2} = \frac{ud2e}{A^2 h_0^2 z_1 \sqrt{h_{1r} - h_{2r} + h_0(z_1 - z_2)}}|_{t=k\delta}$$

with

$$u_{d2e} = \left(-\frac{K}{4}\right)(3c_1^2 h_0 z_1 \sqrt{h_{1r} - h_{2r} + h_0(z_1 - z_2)} - 4KQ_0 c_1 h_{2r} z_1$$

$$+ c_1^2 h_0 z_2 \sqrt{h_{1r} - h_{2r} + h_0(z_1 - z_2)} - 3KQ_0 c_1 h_0 z_1 z_2$$

$$- c_1^2 h_0 z_1 \sqrt{h_{1r} - h_{2r}} - c_1^2 h_0 z_2 \sqrt{h_{1r} - h_{2r}}$$

$$+ 4K^2 Q_0^2 z_1^2 \sqrt{h_{1r} - h_{2r} + h_0(z_1 - z_2)} + 4KQ_0 c_1 h_{1r} z_1$$

$$- 2c_1 c_2 h_0 z_1 \sqrt{h_{2r} + h_0 z_2} + 5KQ_0 c_1 h_0 z_1^2$$

$$- 4KQ_0 c_1 z_1 \sqrt{h_{1r} - h_{2r}} \sqrt{h_{1r} - h_{2r} + h_0(z_1 - z_2)}).$$

A coordinates change is required to express this controller into the initial physical parameters. A controller containing only the u_{d0} term is called “emulated” and represents the usual digital implementation of the continuous-time controller.

8.4 RESULTS

The results provided in this section are focusing on the benefits of the sampled-data controller compared to the emulations of the continuous-time controller.

8.4.1 Preliminary result

As the sampled-data design concerns the reproduction under sampling of the continuous-time Lyapunov evolution of the closed loop dynamics, some simulations were performed to evaluate the matching error between these evolutions under the action of an emulated or under a second order controller, respectively. These simulations are also necessary to fix the admissible sampling period and the gain of the controller.

The error indicator used here is the same defined in [Section 5.2.4](#).

In [Figure 8.2](#) there are plotted the error criteria values for gain K , of the controller, within the range $[1, 40]$ and for a sampling period between $[0.5, 10]$ seconds. The results confirm that the use of a second order controller reduces the amplitudes of the error and makes available the use of higher sampling periods or of higher gains.

8.4.2 Experimental results

For the practical implementations we have considered a gain $K = 20$, the sampling period was given within the range $[1, 10]$ seconds and the tanks were empty at the start of each experiment.

In [Figures 8.4-8.3](#) there are plotted the evolutions of the tank levels and the control input, for a sampling period equal to 1 second. The reference is given as down staircase signal with values of 70%, 30% and 0% from the maximum height of the tank h_0 . For important changes in the reference points, the control becomes saturated. We have imposed these reference values to show that the controller regulates, with zero static error, any reference given. What we are also interested in, is how the system evolves when increasing the sampling period. In [Figure 8.6](#) there are plotted the same evolutions for a sampling period equal to 10 seconds.

[Figure 8.5b](#)) is an expanded image of [8.5a](#)) which shows that the emulated control becomes unstable, with increasing oscillations. The same observation can be made on the control evolution plot [Figure 8.6d](#)), where the second order controller acts smoother. For sampling periods smaller than 10 s, for

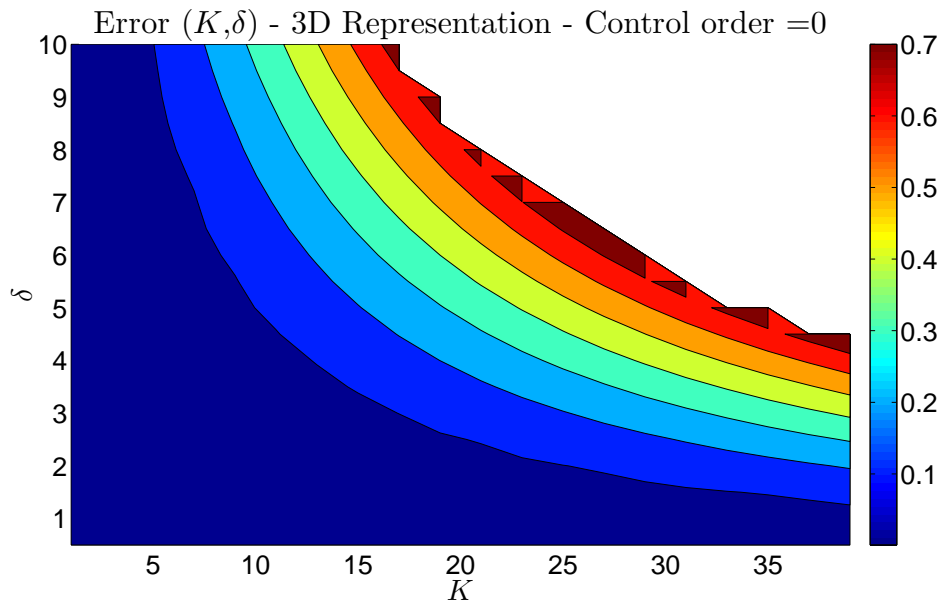

(a) Emulated control

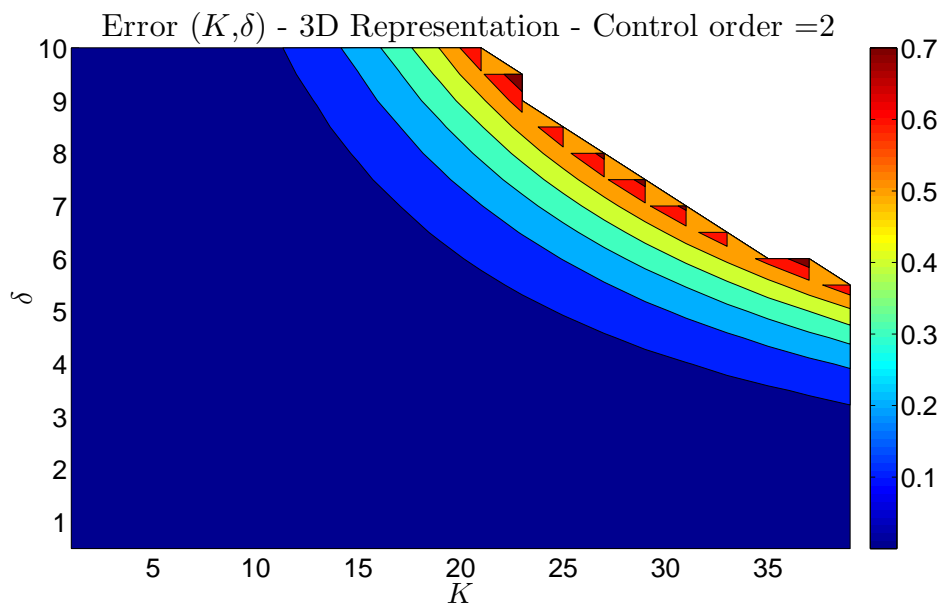

(b) 2nd order control

Figure 8.2: The matching error under sampled-data control

the emulated case the closed loop dynamic is stable but the controller is much more stressed than it is in the case with a second order approximated controller.

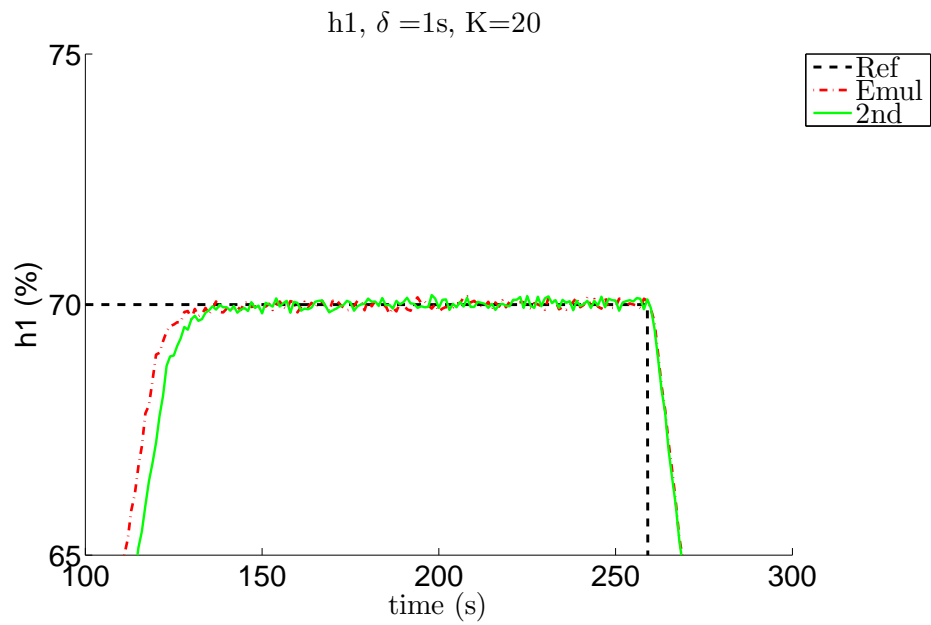
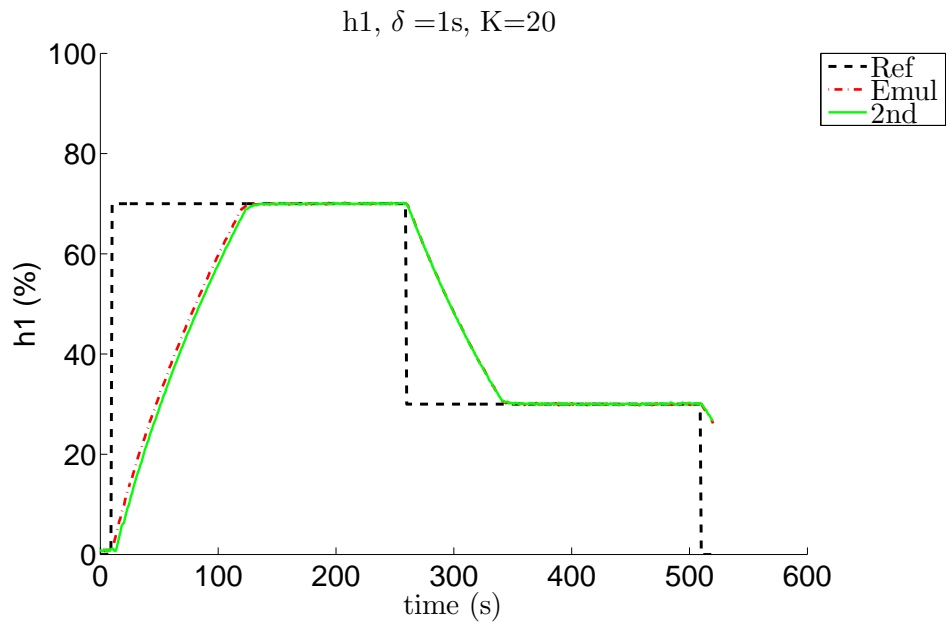
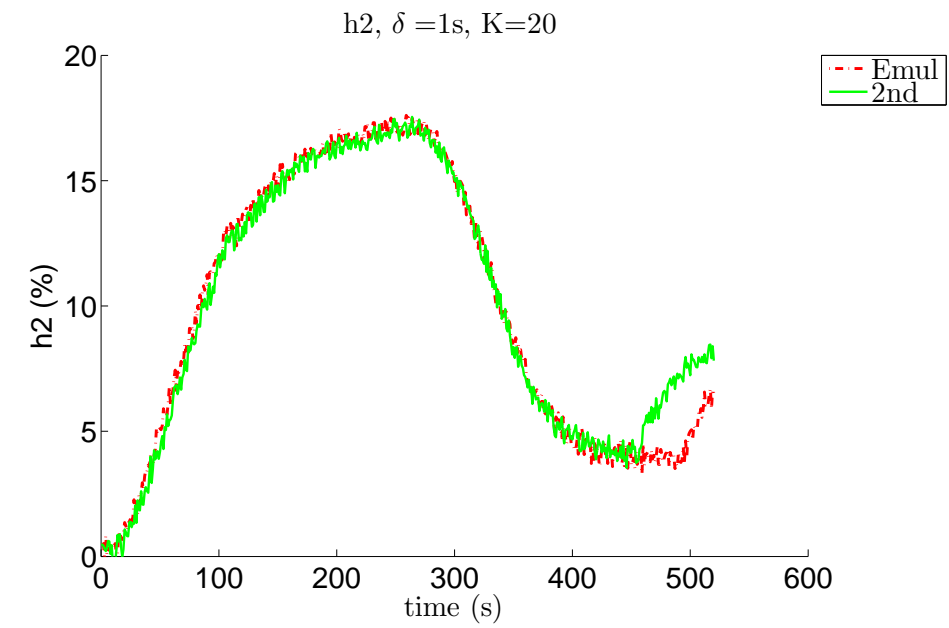
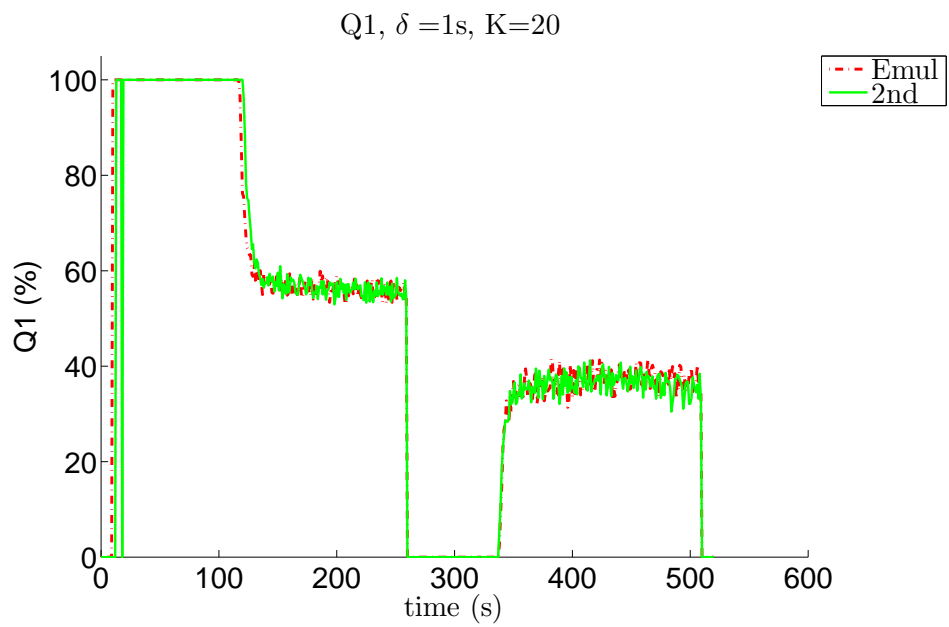
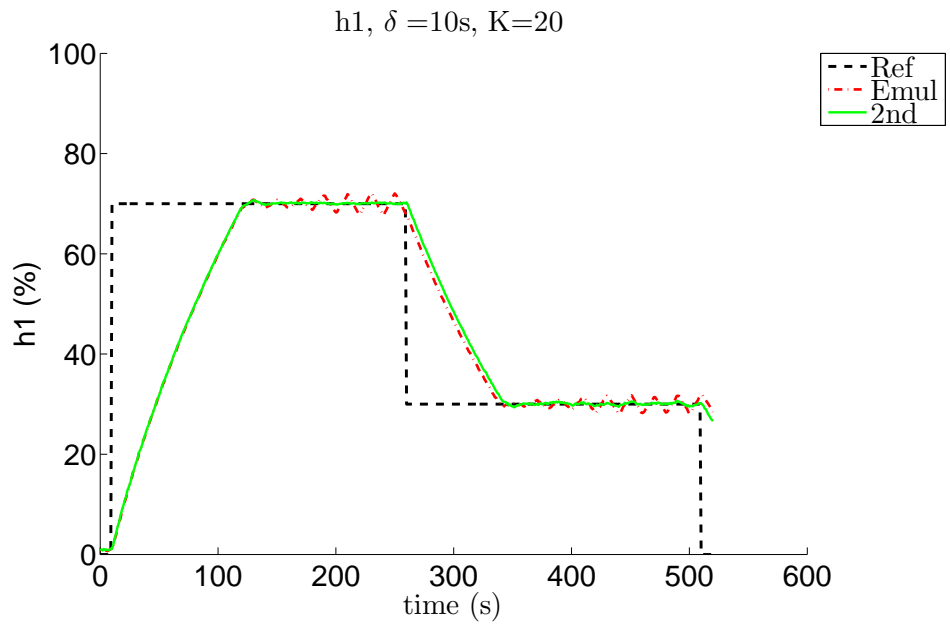
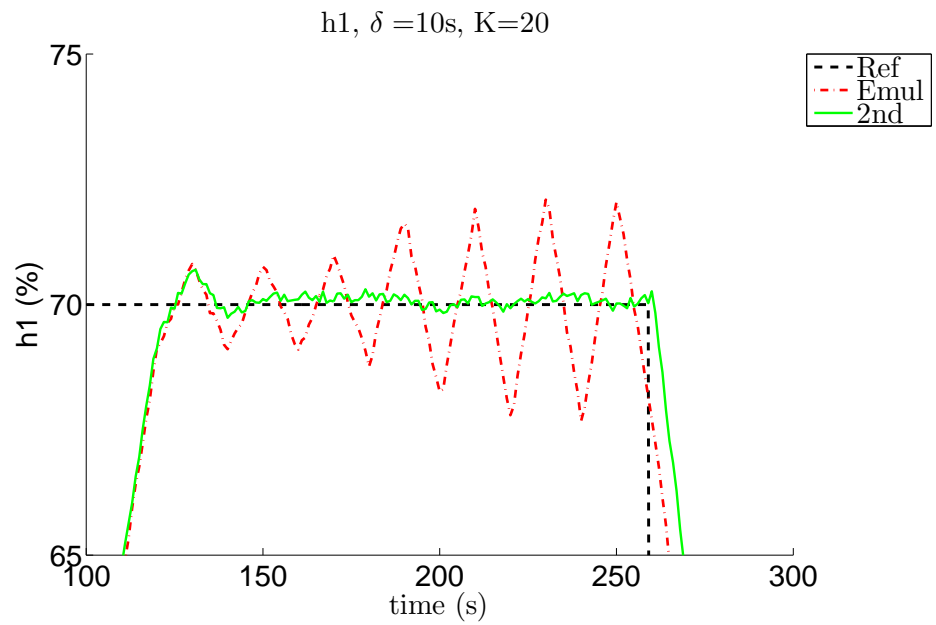

Figure 8.3: Experimental results for $h_1, \delta = 1s$

(a) h_2 (b) Q_1 Figure 8.4: Experimental results for $\delta = 1s$



(a)



(b)

Figure 8.5: Experimental results for h_1 , $\delta = 10s$

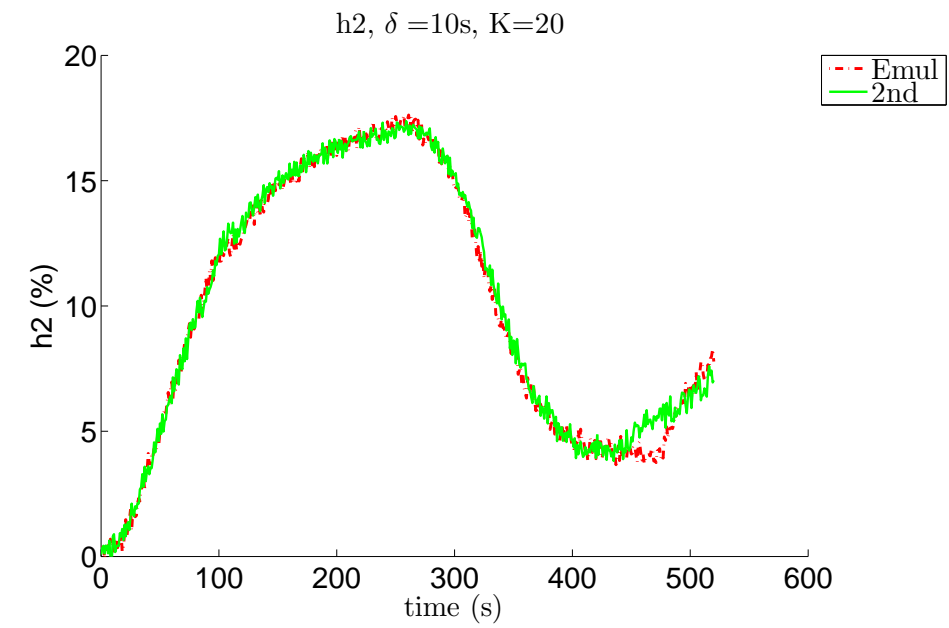
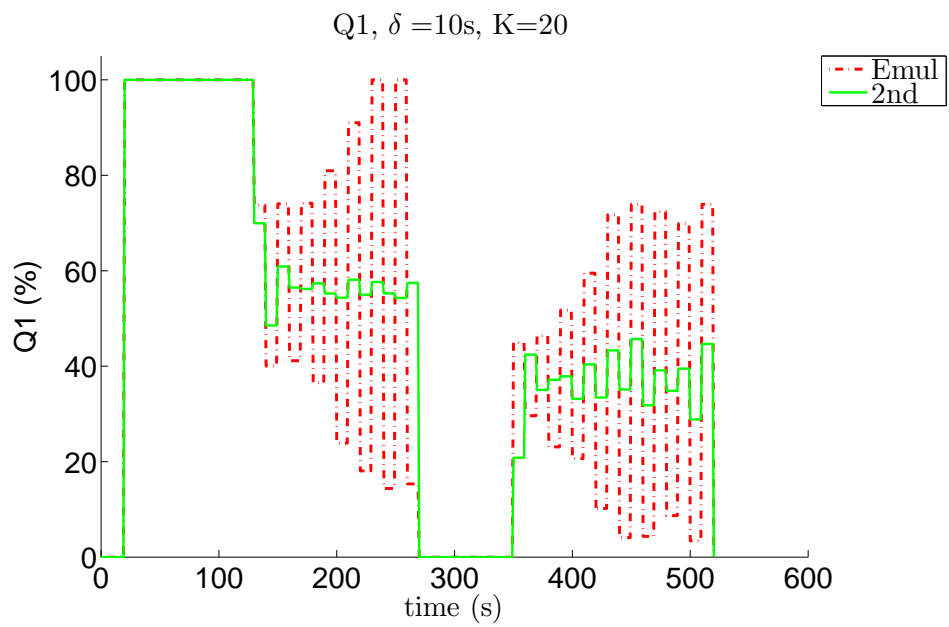
(a) h_2 (b) Q_1 Figure 8.6: Experimental results for $\delta = 10\text{s}$

TWO WHEEL MOBILE ROBOT

The object of this case study is to illustrate on an academic example, subject to communication delays, how discretization makes it possible the design of a prediction based stabilizer. The case of nonlinear dynamics with delayed input admitting finite sampled equivalent models is discussed. The stabilizing strategy with predictor is designed by means of the multi-rate samplings proposed in [Monaco & Normand-Cyrot 1992],[Chelouah *et al.* 1993] or [Di Giamberardino *et al.* 1996b]. Part of the results reported here are included in the papers [P1],[C10] from the author's contribution list (page ix).

9.1 INTRODUCTION

9.1.1 *The two-wheeled mobile robot dynamics*

Let us consider the reduced-order model of the kinematics of a wheeled vehicle with two independent rear motorized wheels, described by the following differential equations:

$$\begin{aligned}\dot{x}(t) &= v(t) \cos(\theta(t)), \\ \dot{y}(t) &= v(t) \sin(\theta(t)), \\ \dot{\theta}(t) &= \omega(t)\end{aligned}\tag{9.1}$$

where v denotes the forward velocity and ω the steering velocity. The kinematics of the mobile robot is considered rolling without slipping on the horizontal plane, which corresponds to the non-holonomic constraint described by [Kojima *et al.* 2010],

$$\dot{x}(t)\sin(\theta(t)) - \dot{y}(t)\cos(\theta(t)) = 0.$$

The velocities v and ω can be expressed in terms of the circular velocities $v_1(t)$, $v_2(t)$ and B the distance between wheels as follows: $v(t) = \frac{v_1(t)+v_2(t)}{2}$, $\omega(t) = \frac{v_2(t)-v_1(t)}{B}$.

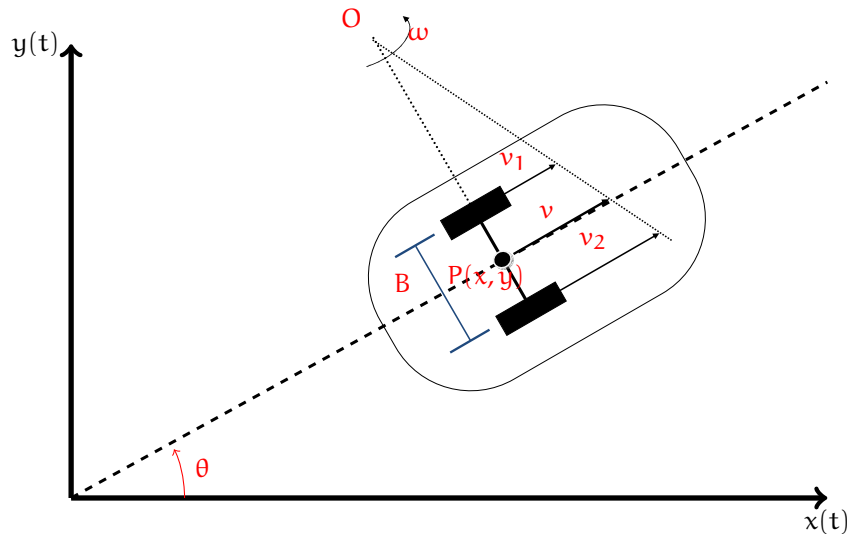

Figure 9.1: Two-wheeled mobile robot

If the presence of a communication delay $\tau = N\delta$, with N positive integer, between the state measurements and the control input, then the kinematics of the mobile robot becomes:

$$\begin{aligned} \dot{x}(t) &= v(t - \tau) \cos(\theta(t)), \\ \dot{y}(t) &= v(t - \tau) \sin(\theta(t)), \\ \dot{\theta}(t) &= \omega(t - \tau) \end{aligned} \tag{9.2}$$

9.1.2 The discretization issue

Let us consider the robot dynamics in the delay free case (9.1). If it is assumed that the control inputs u and v are constant on intervals of length δ , then the sampled equivalent model is described by the next difference equations:

$$\begin{aligned} x_{k+1} &= x_k + \delta v_k \cos(\theta_k) - \frac{\delta^2}{2!} v_k \omega_k \sin(\theta_k) + \dots \\ y_{k+1} &= y_k + \delta v_k \sin(\theta_k) + \frac{\delta^2}{2!} v_k \omega_k \cos(\theta_k) - \dots \\ \theta_{k+1} &= \theta_k + \delta \omega_k \end{aligned} \tag{9.3}$$

which can be rewritten in this particular case as follows:

$$\begin{aligned} x_{k+1} &= x_k + v_k \frac{\sin(\theta_{k+1}) - \sin(\theta_k)}{\omega_k} \\ y_{k+1} &= y_k - v_k \frac{\cos(\theta_{k+1}) - \cos(\theta_k)}{\omega_k} \\ \theta_{k+1} &= \theta_k + \delta \omega_k \end{aligned} \tag{9.4}$$

By looking at the previous equations, it is clear that designing a digital controller is a difficult task since ω_k appears in the trigonometric function argument. As it is shown next, a suitable change of

coordinates allows us to transform this system into the non-holonomic integrator form, which admits an exact sampled-model. Based on the exact sampled-model of finite order in δ , a digital controller can be easily designed to satisfy suitable discrete-time objectives.

9.1.3 *The non-holonomic integrator*

By using the following change of coordinates,

$$\begin{aligned} x_1 &= x \cos(\theta) + y \sin(\theta), \\ x_2 &= x \sin(\theta) - y \cos(\theta), \\ x_3 &= \theta \end{aligned} \tag{9.5}$$

and the input transformation,

$$u_1 = v - x_2 \omega, \quad u_2 = \omega \tag{9.6}$$

the initial system is translated to

$$\begin{aligned} \dot{x}_1(t) &= u_1(t), \\ \dot{x}_2(t) &= u_2(t)x_1(t), \\ \dot{x}_3(t) &= u_2(t). \end{aligned} \tag{9.7}$$

which admits the exact discrete-equivalent of order at most 2 in δ ,

$$\begin{aligned} x_{1\ k+1} &= x_{1\ k} + \delta u_{1\ k}, \\ x_{2\ k+1} &= x_{2\ k} + \delta u_{2\ k} x_{1\ k} + \frac{\delta^2}{2} u_{2\ k} u_{1\ k}, \\ x_{3\ k+1} &= x_{3\ k} + \delta u_{2\ k}. \end{aligned} \tag{9.8}$$

9.2 THE DIGITAL CONTROL DESIGN FOR DELAY FREE CASE

We propose a stabilizing 2-rate digital controller based on the dead-beat design. The controller is designed to bring the system in 2 steps of length $\delta/2$ to a desired point $x_d(k) \in \mathbb{R}^3$. Let us now propose the following multi-rate controller:

- $u_{1\ k} = u_1(t_k)$, for $t_k = [k\delta, (k + \frac{1}{2})\delta[$
- $u_{2\ k} = u_2(t_k)$, for $t_k = [k\delta, (k + 1)\delta[$
- $u_{3\ k} = u_1(t_k)$, for $t_k = [(k + \frac{1}{2})\delta, (k + 1)\delta[$

Then at time $t = (k + 1)\delta$ the discrete-time dynamics are described by:

$$\begin{aligned}x_{1\ k+1} &= x_{1\ k} + \frac{\delta}{2}(u_{1\ k} + u_{3\ k}), \\x_{2\ k+1} &= x_{2\ k} + \delta u_{2\ k} x_{1\ k} + \frac{\delta^2}{8} u_{2\ k} (3u_{1\ k} + u_{3\ k}), \\x_{3\ k+1} &= x_{3\ k} + \delta u_{2\ k}.\end{aligned}\tag{9.9}$$

Given a desired discrete-time point $x_{d\ k} = (x_{1\ d\ k}, x_{2\ d\ k}, x_{3\ d\ k})$, and assuming $x_k = x_{d\ k}$ then the digital control which brings x_k to $x_{d\ k+1}$ is given by

$$\begin{aligned}u_{1\ k} &= \frac{4}{\delta} \frac{x_{2\ d\ k} - x_{2\ k} - x_{1\ k}(x_{3\ d\ k} - x_{3\ k})}{x_{3\ d\ k} - x_{3\ k}} - \frac{x_{1\ d\ k} - x_{1\ k}}{\delta}, \\u_{2\ k} &= \frac{x_{3\ d\ k} - x_{3\ k}}{\delta}, \\u_{3\ k} &= -\frac{4}{\delta} \frac{x_{2\ d\ k} - x_{2\ k} - x_{1\ k}(x_{3\ d\ k} - x_{3\ k})}{x_{3\ d\ k} - x_{3\ k}} + 3 \frac{x_{1\ d\ k} - x_{1\ k}}{\delta}.\end{aligned}\tag{9.10}$$

or under a simplified form $u_k = \gamma^\delta(x_k, x_{d\ k})$.

The controller is well defined for $x_{3\ d\ k} - x_{3\ k}$ is not zero. The case when it is 0, physically corresponds to the situation when the robot has the steering velocity equal to 0, and hence the robot is moving only in the direction defined by x and y , it is not able to move to a position that is parallel with this trajectory (the parallel parking problem [Paromtchik & Laugier 1996],[Di Giamberardino *et al.* 1996a]). To avoid this problem, we impose an asymptotic discrete-time evolution of x_3 dynamics (to the angle of rotation of the robot vehicle) e.g. $x_{3\ d\ k} = x_{30}/k^2$, with k as the sampling instant, and for the other trajectories we can ask the exact tracking with $x_{1\ d\ k} = 0$ and $x_{2\ d\ k} = 0$. As consequence in only 2 steps (one sampling period) the vehicle arrives to the desired position and asymptotically it adapts the desired orientation.

For comparative purposes we use another different dead-beat solution, proposed in [Karafyllis & Krstic 2011] which achieves the stabilization in 3 steps.

9.2.1 Piecewise continuous-time controller

If we go back to the initial coordinates, one gets:

$$\begin{aligned}v(t) &= u_{1\ k} + x_2(t)u_{2\ k}, \quad t \in [k\delta, (k + \frac{1}{2})\delta) \\v(t) &= u_{3\ k} + x_2(t)u_{2\ k}, \quad t \in [(k + \frac{1}{2})\delta, (k + 1)\delta) \\ \omega(t) &= u_{2\ k}, \quad t \in [k, (k + 1)\delta)\end{aligned}\tag{9.11}$$

As a consequence ω is still a discrete-time signal, while v is piecewise continuous because it depends on $x_2(t)$. The state variable $x_2(t)$ can be computed exactly as follows:

$$\begin{aligned} x_2(t) &= x_{2k} + t u_{2k} \left(x_{1k} + \frac{t}{2} u_{1k} \right), \quad t \in [k\delta, (k + \frac{1}{2})\delta) \\ x_2(t) &= x_{2k+\frac{1}{2}} + t u_{2k} \left(x_{1k+\frac{1}{2}} + \frac{t}{2} u_{3k} \right), \quad t \in [(k + \frac{1}{2})\delta, (k + 1)\delta) \end{aligned}$$

with

$$x_1(k + \frac{1}{2}) = x_1(k) + \frac{\delta}{2} u_1(k), \quad (9.12)$$

$$x_2(k + \frac{1}{2}) = x_2(k) + \frac{\delta}{2} u_2(k) x_1(k) + \frac{\delta^2}{8} u_2(k) u_1(k). \quad (9.13)$$

9.2.2 Controllers implementation

If we take into account a practical implementation of the piecewise continuous-time controllers (let us denote this controller by **MRCont**) defined by the equations (9.11) then the discrete-time versions have to be also evaluated.

A first solution **MRHold** is to use an emulated version, where $x_2(t)$ is considered constant over time intervals of length $\delta/2$, then:

$$v_k = u_{1k} + x_{2k} u_{2k}, \quad t \in [0, (k + \frac{1}{2})\delta) \quad (9.14)$$

$$v_k = u_{3k} + x_{2k+\frac{1}{2}} u_{2k}, \quad t \in [(k + \frac{1}{2})\delta, (k + 1)\delta) \quad (9.15)$$

It is a known fact that the use of emulated controllers reduces the stabilizing performances imposed by the continuous-time design.

A second solution **MRCorr** that tries to cancel the effect of holding $x_2(t)$ proposes a correction on computing the discrete value of x_{2k} , such that

$$v_k = u_{1k} + x_{2k}^c u_{2k}, \quad t \in [k\delta, (k + \frac{1}{2})\delta) \quad (9.16)$$

$$v_k = u_{3k} + x_{2k+\frac{1}{2}}^c u_{2k}, \quad t \in [(k + \frac{1}{2})\delta, (k + 1)\delta) \quad (9.17)$$

Let us define next the error expressions:

$$\epsilon_1(t) = x_{2k}^c - x_2(t), \quad t \in [k\delta, (k + \frac{1}{2})\delta) \quad (9.18)$$

$$\epsilon_2(t) = x_{2k+\frac{1}{2}}^c - x_2(t), \quad t \in [(k + \frac{1}{2})\delta, (k + 1)\delta) \quad (9.19)$$

The criterion used to find the proper x_{2k}^c is

$$\int_0^{\delta/2} \epsilon_i(t) dt = 0, \quad i = 1, 2. \quad (9.20)$$

Some computations show starting with (9.12) and (9.18):

$$\begin{aligned} & \int_0^{\delta/2} x_{2k}^c - x_{2k} - t u_{2k} x_{1k} - \frac{t^2}{2} u_{2k} u_{1k} dt \\ &= \frac{\delta}{2} (x_{2k}^c - x_{2k}) - \frac{\delta^2}{8} u_{2k} x_{1k} - \frac{\delta^3}{48} u_{2k} u_{1k} \end{aligned}$$

In same manner for the second interval evolution of $x_2(t)$ one finally gets the solutions of the criteria:

$$x_{2k}^c = x_{2k} + \frac{\delta}{4} u_{2k} x_{1k} + \frac{\delta^2}{24} u_{2k} u_{1k} \quad (9.21)$$

$$x_{2k+\frac{1}{2}}^c = x_{2k}^c + \frac{\delta}{4} u_{2k} x_{1k} + \frac{\delta^2}{24} u_{2k} (u_{1k} + u_{3k}) \quad (9.22)$$

With these last computations we conclude that the **MRCorr** controller defined by equations (9.16)-(9.17) and (9.21)-(9.22) represents the control solution when dealing with the implementation of the continuous-time version, when using holding devices on control inputs u_1, u_2 .

9.3 THE DIGITAL CONTROL WITH DELAY PREDICTOR

In the presence of inputs delay the controller proposed in the delay free case $u_k = \gamma^\delta(x_k, x_{dk})$ has to be use with a state predictor z_k .

In the case of a delay $\tau = N\delta$ on the inputs v and ω the input transformation has the following form

$$u_1(t - \tau) = v(t - \tau) - x_2(t)\omega(t - \tau), \quad u_2(t - \tau) = \omega(t - \tau) \quad (9.23)$$

which translates the initial system into (9.2). The problem is to build an N step predictor, by making use of the finite discretization equivalent of the system (9.7). When a control is delayed with N steps, this means that the controller computes a digital value u_k at instant $k\delta$ which is applied to the system at instant $(k + N)\delta$. As consequence the controller action defined in the past is not suitable since the states have evolved to other values. So at the instant $k\delta$ one must compute the state values at instant $(k + N)\delta$.

The N step predictor can be easily computed from (9.8) by successive iterations, so getting:

$$\begin{aligned} z_{1k+N} &= z_{1k} + \delta \sum_{i=0}^{N-1} u_{1k-i}, \\ z_{2k+N} &= z_{2k} + \delta z_{1k} \sum_{i=0}^{N-1} u_{2k-i} \\ &+ \frac{\delta^2}{2} \left(\sum_{i=0}^{N-1} u_{1k-i} u_{2k-i} + 2u_{2k-i} \sum_{j=i+1}^N u_{1k-j} \right), \\ z_{3k+N} &= z_{3k} + \delta \sum_{i=0}^{N-1} u_{2k-i} \end{aligned} \quad (9.24)$$

with $z_{ik} = x_{ik}$, $i = 1, 2, 3$.

It is clear from the above, the last N control inputs are required to compute the states at the instant $(k + N)\delta$. In the case of a 2-rate sampling scheme, the predictor is computed as follows:

$$\begin{aligned}
 z_{1k+N} &= z_{1k} + \frac{\delta}{2} \sum_{i=0}^{N-1} (u_{1k-i} + u_{3k-i}), \\
 z_{2k+N} &= z_{2k} + \delta z_{1k} \sum_{i=0}^{N-1} u_{2k-i} \\
 &\quad + \frac{\delta^2}{8} \left(\sum_{i=0}^{N-1} (u_{2k-i} (3u_{1k-i} + u_{3k-i})) \right. \\
 &\quad \left. + 4u_{2k-i} \sum_{j=i+1}^{N-1} (u_{1k-j} + u_{3k-j}) \right), \\
 z_{3k+N} &= z_{3k} + \delta \sum_{i=0}^{N-1} u_{2k-i}
 \end{aligned} \tag{9.25}$$

The initial conditions of this predictor are represented by the state measurements $z_{ik} = x_{ik}$.

The predictor is used to set the controller $u_{dpk} = \gamma^\delta(z_{k+N})$ that stabilizes the system (9.7) for a delay $\tau = N\delta$, for any $N > 0$. Translating now into initial coordinates, the digital controller with predictor becomes:

$$\begin{aligned}
 v(t) &= u_{1dpk} + x_2(t)u_{2dpk}, \quad \omega(k) = u_{2dpk}, \\
 &\quad t \in [k\delta, (k + \frac{1}{2})\delta)
 \end{aligned} \tag{9.26}$$

$$\begin{aligned}
 v(t) &= u_{3dpk} + x_2(t)u_{2dpk}, \quad \omega(k) = u_{2dpk}, \\
 &\quad t \in [(k + \frac{1}{2})\delta, (k + 1)\delta)
 \end{aligned} \tag{9.27}$$

This solution assures the stabilization in 2 steps of time length $\delta/2$ of the dynamics (9.7), in the presence of inputs delays.

When considering ZOH blocks on v and w it is clear that the predictor given in (9.24) becomes inexact due to the fact that $x_2(t)$ is hold constant. To correct the control solution the same corrections on v_k (9.21)-(9.21) have to be considered:

$$v_k = u_{1dpk} + z_{2k}^c u_{2dpk} \tag{9.28}$$

$$v_k = u_{3dpk} + z_{2k+\frac{1}{2}}^c u_{2dpk} \tag{9.29}$$

with

$$z_{2k}^c = z_{2k} + \frac{\delta}{4} u_{2k} z_{1k} + \frac{\delta^2}{24} u_{2k} u_{1k} \tag{9.30}$$

$$z_{2k+\frac{1}{2}}^c = z_{2k}^c + \frac{\delta}{4} u_{2k} z_{1k} + \frac{\delta^2}{24} u_{2k} (u_{1k} + u_{3k}) \tag{9.31}$$

By taking into account that v and ω are constant then another predictor can be designed from the discrete-time equivalent (9.4). In a multi-rate context, previously defined, it takes the following form:

$$\begin{aligned}
 X_{k+N} &= X_k + \sum_{i=0}^{N-1} v_{k+i} \frac{\sin(\Theta_{k+i+\frac{1}{2}}) - \sin(\Theta_{k+i})}{\omega_{k+i}} \\
 &+ \sum_{i=0}^{N-1} v_{k+i+\frac{1}{2}} \frac{\sin(\Theta_{k+i+1}) - \sin(\Theta_{k+i+\frac{1}{2}})}{\omega_{k+i+\frac{1}{2}}} \\
 Y_{k+N} &= Y_k - \sum_{i=0}^{N-1} v_{k+i} \frac{\cos(\Theta_{k+i+\frac{1}{2}}) - \cos(\Theta_{k+i})}{\omega_{k+i}} \\
 &- \sum_{i=0}^{N-1} v_{k+i+\frac{1}{2}} \frac{\cos(\Theta_{k+i+1}) - \cos(\Theta_{k+i+\frac{1}{2}})}{\omega_{k+i+\frac{1}{2}}} \\
 \Theta_{k+N} &= \Theta_k + \delta \sum_{i=0}^{N-1} \omega_{k+i}
 \end{aligned} \tag{9.32}$$

The previous predictor proposed in [Karafyllis & Krstic 2011] offers the exact estimations of the state variables when using a ZOH block on v .

9.3.1 Simulation results

The simulations are provided considering a sampled-data scheme with the continuous-time model of the robots kinematics (9.1) with digital control inputs passed through a ZOH block. The state measures are delayed with $\tau = 3\delta$ ($N=3$) and measured with a sampling rate $\delta = 1$ second. The analysis of the simulation results plotted in figures Figure 9.2 and Figure 9.3 is given next.

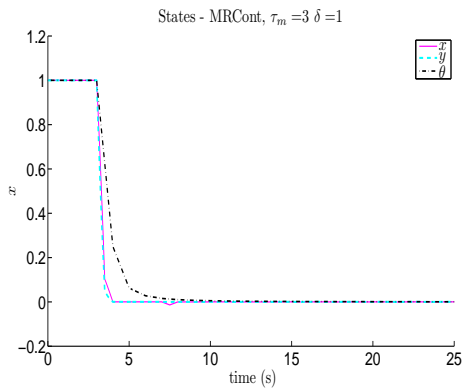

(a) MRCont

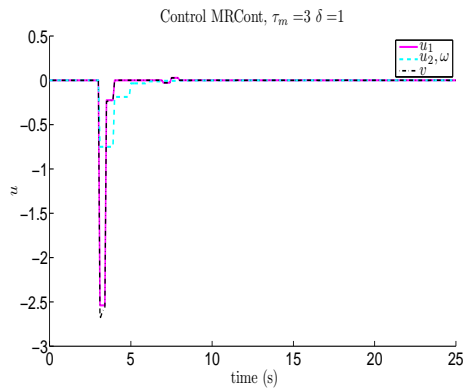

(b) MRCont

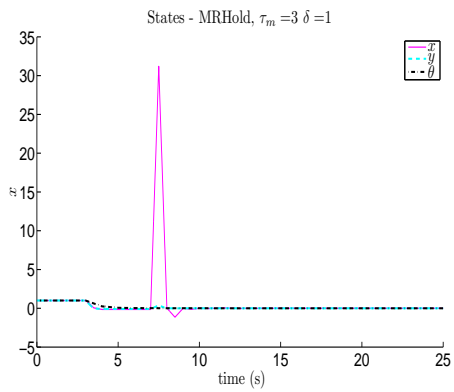

(c) MRHold

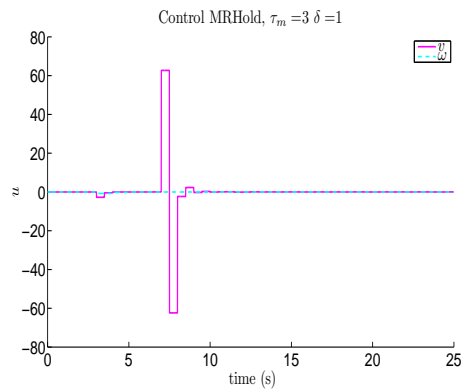

(d) MRHold

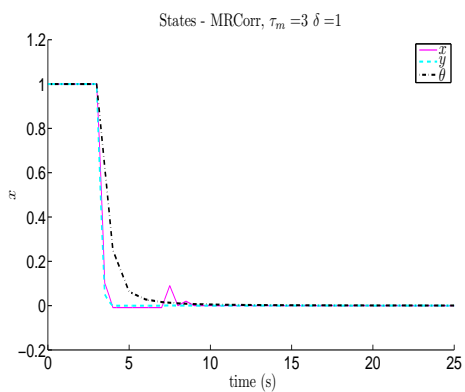

(e) MRCorr

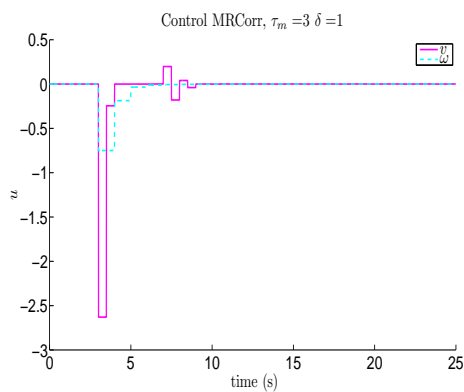

(f) MRCorr

Figure 9.2: State evolutions, for $\delta = 1$ s, $\tau = 3$

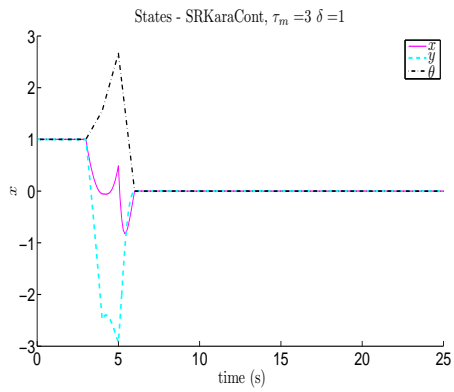

(a) SRKara Cont

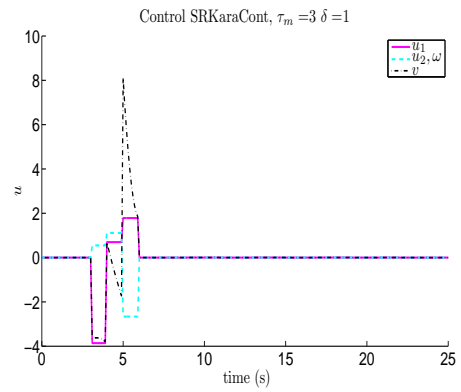

(b) SRKara Cont

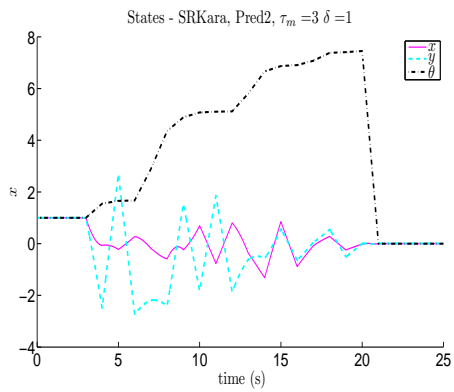

(c) SRKara Hold

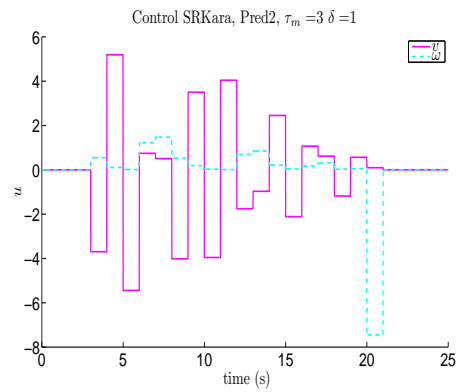

(d) SRKara Hold

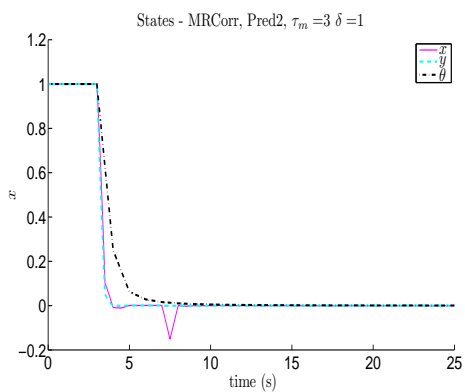

(e) MRCorr Pred2

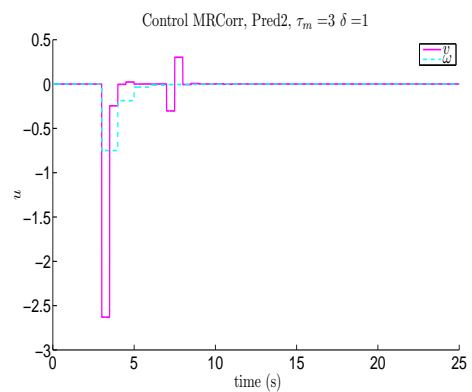

(f) MRCorr Pred2

Figure 9.3: State evolutions, for $\delta = 1s, \tau = 3$

- MRCont** This solution uses the continuous-time controller $v(t)$ (no ZOH block used are used on v). This case, which is an ideal one, cannot be practically implemented. This controller is used in connection with the predictor (9.25). The stabilization for x , y is achieved in 2 steps, in other words in one sampling time. Simulation results are plotted in Figure 9.2a), b). Small peaks can be observed this due to the integration errors of the continuous time dynamics.
- MRHold** This solution is obtained by holding the continuous-time controller $v(t)$ constant on $\delta/2$ intervals in connection with the predictor (9.25). Simulation results are plotted in Figure 9.2c), d). This solution presents some undesirable peaks at instants $(N + 1 + i/2)\delta$ with $i = 1, 2, \dots$. This is due to the inexact nature of the predictor resulted by holding $v(t)$ constant over the sampling intervals.
- MRCorr** This solution, similar with MRHold, has included the corrections (9.28)- (9.29) on the controller v . The peaks obtained, when using this control, are significantly reduced. The amplitude of these peaks is due to the integration errors of the continuous-time dynamics. This depends also on the amplitude of the delay. The results are reported in Figure 9.2e), f). For comparative purposes in Figure 9.3e), f) the same controller is used with the predictor (9.32), proposed in [Karafyllis & Krstic 2011]. The results are similar with bigger peaks.
- SRKaraCont** This solution uses a single-rate, dead beat controller proposed in [Karafyllis & Krstic 2011], in conjunction with the exact predictor (9.24) (the single-rate version). Here is reported the “continuous” version which means that $v(t)$ is not passed through a ZOH block. Simulation results are plotted in Figure 9.3a), b). The solution is stabilizing in 3 sampling steps. The y steady-state value has a bias error, which depends on the choice of the error size in the controller algorithm.
- SRKara** This solution is similar with SRKaraCont with the difference that $v(t)$ is passed through a ZOH block. In Figure 9.3c), d) the results are obtained in conjunction with the exact predictor (9.32) (the single-rate version). In this case the controller solution take greater time to stabilize. The y steady-state value has also a bias error, which depends on the choice of the error size in the controller algorithm.

In conclusion, the control strategy and the exact delay predictor proposed performs better and achieves the stabilization of the dynamics of the mobile robot, in a sampled-data context with delayed communications. The construction of the delay predictor is possible due to the exact discrete-time equivalent of the non-holonomic integrator. The delay predictor proposed here is a better version to be used compared with the one proposed in [Karafyllis & Krstic 2011]. The delay predictor is also computed for second-rate controllers.

FUEL CELL/SUPER-CAPACITOR - ENERGETIC MANAGEMENT

The object of this case study is to design sampled-data versions of two different nonlinear control strategies that concern the energy management of a fuel cell system: one strategy is relying on passivity based control IDA -PBC and the second one relying on the theory of singular perturbations. The performances of the digital controllers are tested in simulations and evaluated on an experimental setup available at the LGEP¹. Part of the results reported here are included in the papers [Co6],[Co8] from the author's contribution list (page ix).

10.1 INTRODUCTION

One of the most demanding action nowadays concerns the development of alternative energy sources, taking into account pollution aspects and the limited available resources. In this battle, the automotive industry showed, in the last decades, an increased interest in developing environmentally friendly - electrical vehicles. More precisely, the interest is to develop a cheap and efficient energy source and storage system, capable to respond to large power demands and to assure as much as possible a great vehicle's autonomy.

In this context, a solution, that concern many researches, is based on the development of fuel cell systems having a proton exchange membrane as main source of energy. Besides it has important advantages such as: reduced pollution and noise, modularity or high efficiency; the obstacles do exist such as: cost, reliability and durability. In order to assure a good state of health of the fuel cell system it is required that the current delivered by FC should not fluctuate more than 10 A during each second for a system with 20kW/48V as the one available at the LGEP.

To comply with the problem of higher power demands in short time, the FC can be associated with auxiliary sources such as batteries or super capacitors (SCs) [Ghanes *et al.* 2011].

¹ Laboratoire de Génie Electrique de Paris, UMR 8507, 11 Rue Joliot Curie, Gif-sur-Yvette

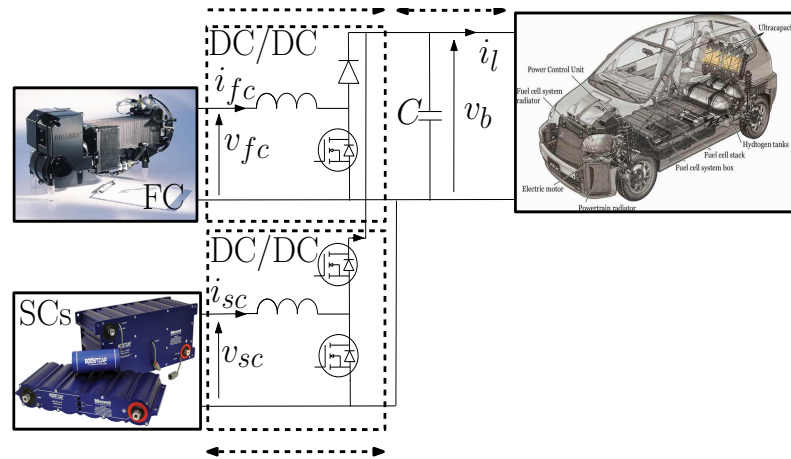

Figure 10.1: System architecture [Ghanes *et al.* 2011]

In this case study an FC system with SCs is studied in connexion with double converters in a parallel structure, see Figure 10.1. Using a double converter allows better control capabilities but increases energetic losses. As discussed in [Tiefensee *et al.* 2010a], the FC converter permits a one-way power flow with two goals: to supply the load power demands first and then to charge the SC. On the other hand the SC's converter permits two-way power flow which allows to supply the load (the SC recharge) which can be done either by the FC or by the vehicle regenerative braking system.

The energetic management of such system can be realized by a controller that has to ensure three major objectives:

- to comply with the FC dynamics (the limitations of the currents and of the sudden variations);
- to control the charge of the storage devices (SCs);
- to control the power response (either positive or negative) required by the electrical load.

Several linear and nonlinear control strategies have been proposed to pilot each converter, to control the DC bus voltage and the SC's charge respectively. A more detailed survey about these strategies can be found in [Azib *et al.* 2011]. This chapter concerns mainly two non-linear approaches that were developed in the continuous-time context. The first one **IDA-PBC** was first proposed by [Ortega *et al.* 2002] and adapted to a fuel cell system with SCs in the papers of [Becherif *et al.* 2006], [Hilairet *et al.* 2010]. This novel method is very efficient to design stabilizing controllers for electro-mechanical systems which can be energetically shaped. It relies on specific state space structures like Hamiltonian ones.

The second approach, of the **Singular Perturbation Theory (SPT)**, [Kokotovic *et al.* 1986] is suitable for systems which admit multiple time-scales dynamics. The problem at hand can be divided into 3 time-scales : the current loops which are the fastest ones, the SC's current which is slower

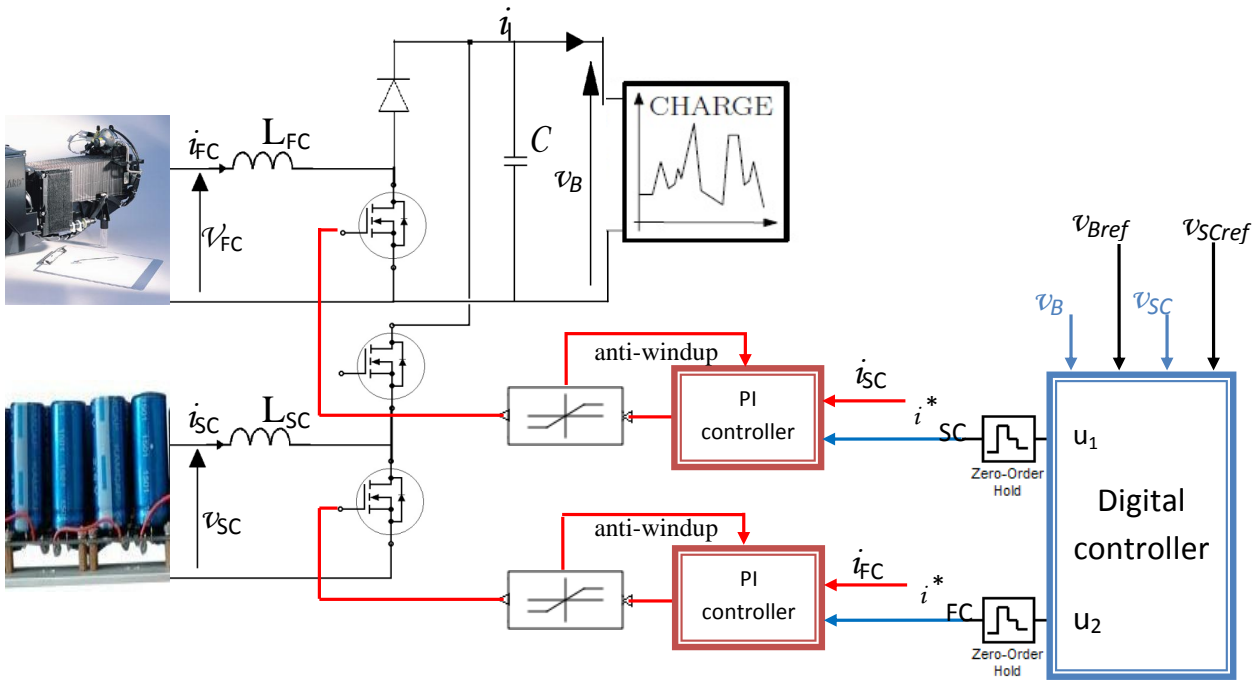

Figure 10.2: Control scheme

and the FC current that must have the slowest variation. Previous works have been performed in [Ghanes *et al.* 2011] or [Ghanes *et al.* 2012].

By taking into account the practical implementations, the design is set in a sampled-data context. The emulation procedure does not always give satisfactory results. The object of this study is to analyze, from the point of the view of these two nonlinear strategies proposed, how the emulation is affected and when it is unavoidable to propose specific digital versions of such controllers.

10.2 SYSTEM ARCHITECTURE

The control structure scheme of the system FC/SCs is depicted in Figure 10.2. It consists in a cascade hybrid control structure, which was proposed in [Cacciato *et al.* 2004, Thounthong *et al.* 2005]. Power requirements, speed variations, various frictions, are reported on the electric charge. The proposed architecture allows a decoupling frequency of the load demand. The bus capacitor C filters high frequencies, the boost converter of the SCs medium frequencies, and the associated converter of the FC, low frequencies.

The objective of the control scheme is to maintain the bus voltage to a constant reference value v_B^* and to ensure that the evolutions of the currents i_{FC} and i_{SC} are bounded in order to protect sources and converters of load variations. The scheme provides two internal loops of current (proportional

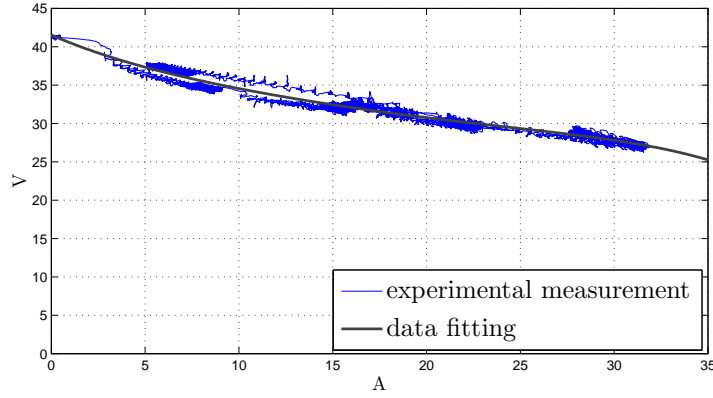

Figure 10.3: Static characteristic of the FC

integral PI) ensuring a rapid convergence to the respective references i_{FC}^* and i_{SC}^* . The control design objective is to provide these current references for the digital controller.

The model used hereafter, is the same as the one provided in the work of the principal collaborators, e.g. [Hilaret *et al.* 2010, Tiefensee *et al.* 2010a].

10.2.1 The FC model

Static modeling was used to calculate the voltage v_{FC} according to the fuel cell current i_{FC} thus resulting in a polynomial function of 5th order. This was determined by data-fitting of the measured experimental data and it is represented in Figure 10.3.

10.2.2 FC boost converter

As the FC voltage v_{FC} is always inferior to the bus voltage reference v_B^* , the converter should increase the FC voltage to maintain a constant bus voltage for any current i_{FC} . The converter input is given by a binary function and α_1 is its duty cycle. If we consider ideal switches and the FC current, provided by the fast loop PI, piecewise constant, then on each sampling interval, the average dynamics of the converter can be described as follows :

$$\begin{aligned} \frac{di_{FC}(t)}{dt} &= \frac{1}{L_{FC}} (-(1 - \alpha_1)v_B(t) + v_{FC}) \\ \frac{dv_B}{dt} &= \frac{1}{C} ((1 - \alpha_1)i_{FC} - i_L) \end{aligned} \quad (10.1)$$

with i_L the load current.

10.2.3 SCs boost converter

The super capacitors used have a constant capacity C_{SC} and losses are negligible. It is associated with an inductance L_{SC} and an elementary switching cell which allows current to flow into both directions. There are thus two types of operations: an operation load when the SC receives energy from the DC bus operation and a discharge operation respectively, when the SC provides power to the bus. As before, the control of the converter is given by a binary function with α_2 as its duty cycle. If there are considered ideal switches and the FC current, provided by the fast loop PI, is piecewise constant, then for each sampling interval, one can describe the average dynamics of the converter as follows:

$$\begin{aligned}\frac{di_{SC}(t)}{dt} &= \frac{1}{L_{SC}} (-(1 - \alpha_2)v_B(t) + v_{SC}) \\ \frac{dv_{SC}}{dt} &= -\frac{i_{SC}}{C_{SC}}\end{aligned}\quad (10.2)$$

10.2.4 DC bus and the load model

The load is modeled by a circuit series R_L, L_l with R_L depending on the power demanded by the load. More accurately, the following dynamics describes the average model of the load and of the DC bus:

$$\begin{aligned}\dot{v}_B(t) &= \frac{1}{C} ((1 - \alpha_1)i_{FC}(t) + (1 - \alpha_2)i_{SC}(t) - i_l(t)) \\ \dot{i}_l(t) &= \frac{-R_l i_l(t) + v_B(t)}{L_l}\end{aligned}\quad (10.3)$$

10.2.5 The complete model

Setting $x = [x_1, x_2, x_3, x_4, x_5] = [v_B, v_{SC}, i_L, i_{FC}, i_{SC}]$, the complete model is given by:

$$\begin{aligned}\dot{x}_1(t) &= \frac{1}{C} ((1 - \alpha_1)x_4 + (1 - \alpha_2)x_5 - x_3(t)) \\ \dot{x}_2(t) &= -\frac{x_6(t)}{C_{sc}} \\ \dot{x}_3(t) &= \frac{-R_l x_3(t) + x_1(t)}{L_l} \\ \frac{dx_4(t)}{dt} &= \frac{1}{L_{FC}} (-(1 - \alpha_1)x_1(t) + v_{FC}) \\ \frac{dx_5(t)}{dt} &= \frac{1}{L_{SC}} (-(1 - \alpha_1)x_1(t) + x_2)\end{aligned}\quad (10.4)$$

The resulting model has a linear free dynamics and the nonlinearities of the forced terms have to be noticed. Nonlinear techniques allow global asymptotic stabilization of the FC-SCs system. Another important remark to be noticed when designing a controller is that this system has a 2 time-scale behavior: fast for the current loops, and slow for the voltage dynamics.

When one also considers the electrical losses of the converters, a current i_d can be added to the bus voltage dynamics e.g.

$$\dot{x}_1(t) = \frac{1}{C} ((1 - \alpha_1)x_4 + (1 - \alpha_2)x_5 - x_3(t) - i_d(t)) \quad (10.5)$$

where i_d has 2 components, each one corresponding to the converter, such that:

$$i_d = i_{d1} + i_{d2} = \frac{(V_0 + R_0 x_4)x_4}{x_2} + \frac{(V_0 + T_0 x_5)x_5}{v_{FC}} \quad (10.6)$$

The voltage and the internal resistance V_0 , R_0 characterize the power switches [Ghanes *et al.* 2012].

10.2.6 Reduced order model

The control structure comprises 2 fast PI controllers which control the FET transistors to bring the converter currents to desired values:

$$\alpha_{u1} = K_{i_{FC}} \int_0^t (i_{FC}^* - i_{FC}) dt + K_{p_{FC}} (i_{FC}^* - i_{FC}) \quad (10.7)$$

$$\alpha_{u2} = K_{i_{SC}} \int_0^t (i_{SC}^* - i_{SC}) dt + K_{p_{SC}} (i_{SC}^* - i_{SC}) \quad (10.8)$$

The controllers α_{u1}, α_{u2} are acting as high-gain feedback controllers, and during experimental implementation they are equipped with anti-windup schemes.

For the outer loop control model (for the slow dynamics) the controller references are considered as control variables. Setting $u_1 = i_{FC}^*$, $u_2 = i_{SC}^*$ and the reduced model has the following form:

$$\begin{aligned} \dot{x}_1(t) &= \frac{1}{C} \left(\frac{v_{FC}}{x_1(t)} u_1(t) + \frac{x_2(t)}{x_1(t)} u_2(t) - x_3(t) \right) \\ \dot{x}_2(t) &= -\frac{u_2(t)}{C_{sc}} \\ \dot{x}_3(t) &= \frac{-R_1 x_3(t) + x_1(t)}{L_1} \end{aligned} \quad (10.9)$$

In the next developments, the reduced model (10.9) is used for designing the control laws. For having good convergence properties and to ensure the stability, the dynamics of the outer loop must be slow compared with the PI loops.

10.3 CONTINUOUS-TIME CONTROLLER DESIGN

In this section two continuous-time controller designs, one based on the method of IDA-PBC and the other one on the theory of Singular Perturbation for a FC/SC system are recalled. The conception in continuous-time of such controllers is not the object of this work, but these are of great importance since the digital designs, that are next proposed, rely on the performance of the control objec-

tives imposed in continuous time. The digital designs are based on the idea of preservation of the continuous-time properties under sampling.

10.3.1 IDA-PBC design

The method of Interconnection and Damping Assignment - Passivity Based Controller (IDA-PBC) designed in continuous time in [Ortega *et al.* 2002] exploits the energy property of passivity [Ortega & Spong 1989]. This method consists in shaping a desired internal structure for imposing the dynamics to move to a desired equilibrium point and to inject the required damping. By denoting \mathcal{H} the system energy

$$\mathcal{H}(x_c) = \frac{1}{2}x_c^T Q x_c; \quad Q = \begin{bmatrix} C & 0 & 0 \\ 0 & C_{SC} & 0 \\ 0 & 0 & L_l \end{bmatrix}$$

the dynamics of the reduced model (10.9) can be written in the following *Port Hamiltonian Control - PCH* form :

$$\dot{x}(t) = (\mathcal{J} - \mathcal{R})\nabla\mathcal{H} + g_1(x(t))u_1(t) + g_2(x(t))u_2(t) \quad (10.10)$$

where the interconnection and damping matrices are described by:

$$\mathcal{J} = \begin{bmatrix} 0 & 0 & -\frac{1}{L_l \cdot C} \\ 0 & 0 & 0 \\ \frac{1}{L_l \cdot C} & 0 & 0 \end{bmatrix}, \quad \mathcal{R} = \begin{bmatrix} 0 & 0 & 0 \\ 0 & 0 & 0 \\ 0 & 0 & \frac{R_l}{L_l^2} \end{bmatrix}$$

and the forced terms that are described by the vector fields:

$$g_1 = \begin{bmatrix} \frac{v_{FC}}{C \cdot v_B} \\ 0 \\ 0 \end{bmatrix}, \quad g_2 = \begin{bmatrix} \frac{v_{SC}}{C \cdot v_B} \\ -\frac{1}{C_{SC}} \\ 0 \end{bmatrix}.$$

The continuous-time control laws specified to this case study are:

$$u_{c1}(t) = \frac{v_B(t)}{v_{FC}} \left(\frac{\bar{v}_B}{R_l} + (K_1 \frac{v_{SC}(t)}{v_B(t)} - K_2) \tilde{v}_B(t) - K_1 \tilde{v}_{SC}(t) \right) \quad (10.11)$$

$$u_{c2}(t) = -K_1 \tilde{v}_B(t) \quad (10.12)$$

$$(10.13)$$

with $\tilde{v}(t) = v(t) - \bar{v}$ as the regulation error. The positive gains K_1 et K_2 are chosen in such a way to comply with the desired speed of the system's response.

In this case the PCH system, in closed loop, has the following form :

$$\dot{x}(t) = (\mathcal{J}_d - \mathcal{R}_d)\nabla\mathcal{H}_d(x(t)) \quad (10.14)$$

where the desired energy function $\mathcal{H}_d(\tilde{x}) = (x - \bar{x})^T Q(x - \bar{x})$ has a minimum in the equilibrium point \bar{x} . The new interconnection and damping matrices \mathcal{J}_d respectively \mathcal{R}_d are given by :

$$\mathcal{J}_d = \begin{bmatrix} 0 & -\frac{K_1}{C_{SC} \cdot C} & -\frac{1}{L_1 \cdot C} \\ \frac{K_1}{C_{SC} \cdot C} & 0 & 0 \\ \frac{1}{L_1 \cdot C} & 0 & 0 \end{bmatrix}, \mathcal{R}_d = \begin{bmatrix} \frac{K_2}{C_{bus}^2} & 0 & 0 \\ 0 & 0 & 0 \\ 0 & 0 & \frac{R_1}{L_1^2} \end{bmatrix}.$$

The proof of the asymptotic stability of the solution is given by analyzing the derivative of \mathcal{H}_d :

$$\dot{\mathcal{H}}_d(\tilde{x}) = -(\nabla\mathcal{H}_d(\tilde{x}))^T \mathcal{R} \nabla\mathcal{H}_d(\tilde{x}) \leq 0, \forall x \neq \bar{x} \quad (10.15)$$

and also by applying the invariance LaSalle principle, with $\mathcal{H}_d(\bar{x}) = \dot{\mathcal{H}}_d(\bar{x}) = 0$ (see further details in [Hilairet *et al.* 2010]).

10.3.2 Singular Perturbation design

The Singular Perturbation theory [Khalil 1996], [Barbot *et al.* 1996], [Djemai *et al.* 1999] is suitable for systems which exhibit multiple time-scales dynamics which means that parts of its dynamics are slow and the other ones are fast. One has to take into account that the control objectives, for the FC/SCs system, require that the fast energy demands should be quickly delivered by the SCs; after that the FC will slowly satisfy the demands requirements. This means that fast dynamics should be designed to cope with the SCs source, and a slower one to cope with the FC current source. In this case a solution based on the singular perturbation approach seems to be promising.

The solution was firstly designed for the FC/SCs system, in continuous-time, for the case of lossless converters in [Ghanes *et al.* 2011], and this work follows this result. Details about this approach can be found in [Khalil 1996],[Kokotovic *et al.* 1986].

The objective of the continuous-time controller is to impose faster dynamics for the i_{SC} current loop and slower ones for the i_{FC} current. In the same time, the constraints on the amplitude and speed variation of the fuel cell current should be respected.

In this context, the controller u_1 is designed as follows:

$$u_1(t) = \frac{v_B(t)}{v_{FC}} I_{lm} - \frac{C_{SC}}{T_{lent}} \tilde{v}_{sc}(t) \quad (10.16)$$

where I_{lm} is the load current filtered by a low-pas filter and $\tilde{v} = v - \bar{v}$ represents the variation around the reference point. The choice of the time value T_{lent} for which the current loop is sufficiently slow is important.

For designing the u_2 controller, one imposes to these dynamics be faster than the ones of u_1 but slower than the dynamics of the PI controllers of the converters. The u_2 controller's expression is:

$$u_2(t) = \frac{v_B(t)}{v_{SC}(t)} \left[-\frac{C}{T_{rapide}} \tilde{v}_B(t) - \frac{v_{FC}}{v_B(t)} \left(\frac{v_B(t)}{v_{FC}} I_{lm} - \frac{C_{SC}}{T_{lent}} \tilde{v}_{SC}(t) \right) + I_L(t) \right] \quad (10.17)$$

For analyzing the stability property of such controllers one has to define the Lyapunov functions. In this case one sets the following Lyapunov function: $V = V_1 + V_2 + V_3$, with $V_1 = \tilde{i}^2/2$, $V_2 = \tilde{v}_B^2/2$, and $V_3 = \tilde{v}_{SC}^2/2$ where $\tilde{i} = i_L - \bar{i}_L$ with $\bar{i}_L = v_B^*/R_L(t)$. Its derivative is given by:

$$\dot{V}(t) = \tilde{i}_L(t) \frac{-R_L \tilde{i}_L(t) + \tilde{v}_B(t)}{L} - \frac{\tilde{v}_B^2(t)}{T_{rapide}} \quad (10.18)$$

$$- \frac{\tilde{v}_{SC}(t)}{C_{SC}} \frac{v_B(t)}{v_{SC}(t)} \left[\frac{C}{T_{rapide}} \tilde{v}_B(t) - \frac{v_{FC}}{v_{SC}(t)} \left(\frac{v_B(t)}{v_{FC}} I_{lm} - \frac{C_{SC}}{T_{lent}} \tilde{v}_{SC}(t) \right) + i_L(t) \right] \quad (10.19)$$

By imposing $T_{rapide} \ll 1$ then \tilde{v}_B goes to 0 in an independent way of \tilde{i}_L and \tilde{i}_L exponentially converges to 0 and:

$$\dot{V}(t) = -\frac{R_L}{L} \tilde{i}_L^2(t) - \frac{v_{FC}}{T_{lent} v_{SC}(t)} \tilde{v}_{SC}(t). \quad (10.20)$$

The last equation shows that the system is locally exponentially stable for $v_{SC} > 0$.

10.4 SAMPLED-DATA DESIGNS

10.4.1 IDA-PBC design

In a sampled-data context, it is a fact mentioned in the literature that the passivity properties are lost. In this context a direct design approach was proposed in [Tiefensee *et al.* 2010b, Monaco *et al.* 2011]. In this study, the digital controller is designed by starting from the continuous-time version of IDA-PBC. The resulting controller, piecewise constant over time intervals of length δ , allows to reproduce the energetic objectives, imposed in continuous-time, at each sampling instant. In this context the continuous-time controller is also referred to as the 'ideal' command.

Preliminary results are given in [Hilairet *et al.* 2010] (referring to continuous-time design) and [Tiefensee *et al.* 2010a] (referring to the digital version).

The digital design should preserve the energetic transfers obtained in continuous-time set-up, under sampling and the maintaining of the objectives at each sampling instant. One denotes by $u_k = [u_{1k} \ u_{2k}]$ the digital controllers, and by δ the sampling period used. In order to compute this controller, which reproduces the energetic behavior, the next algebraic equality has to be solved for the initial conditions $x_k = x_c(t = k\delta)$:

$$\mathcal{H}_d(x_{k+1}) - \mathcal{H}_d(x_k) = \int_{k\delta}^{(k+1)\delta} \dot{\mathcal{H}}_d(x_c(\tau)) d\tau \quad (10.21)$$

The left-hand side of the equation regards the sampled-data evolution and the right-hand side the continuous-time one. The solution of this equation can be view also as the solution of an input/Energy matching problem. The function $\mathcal{H}_d(x_{k+1})$ can be computed from $\mathcal{H}_d(x_k)$ as follows:

$$\mathcal{H}_d(x_{k+1}) = e^{\delta((\mathcal{J}-\mathcal{R})\nabla\mathcal{H}(\cdot)+g(\cdot)u_k)}\mathcal{H}_d(x)|_{t=k\delta} \quad (10.22)$$

with the known notations.

The digital controller u_k is computed from the equation (10.21) and the solution is described by a series in terms of δ around the emulated controller $u_{d0} = u_c|_{t=k\delta}$ as follows $u_k = u_{d0} + \sum_{i \geq 1} \frac{\delta}{(i+1)!} u_{di}$. The exact solution corresponds to the asymptotic development. For practical reasons approximated solutions of order 1 or 2 are used with satisfactory performance. The solution that is proposed, is given for a 1st order approximation with an error $O(\delta^2)$:

$$u_{k1}^\delta = \frac{v_B(t)}{v_{FC}} \left(\frac{\bar{v}_B}{R_l} + (K_1 \frac{v_{SC}(t)}{v_B(t)} - K_2) \tilde{v}_B(t) - K_1 \tilde{v}_{SC}(t) \right) |_{t=k\delta} + \frac{\delta}{2!} u_{d11}(t) |_{t=k\delta} \quad (10.23)$$

$$u_{k2}^\delta = -K_1 \tilde{v}_B(t) |_{t=k\delta} - \frac{\delta}{2!} K_1 \dot{v}_B(t) |_{t=k\delta} \quad (10.24)$$

with

$$u_{d11}(t) = \dot{v}_B(t) \left(\frac{u_{c1}(t)}{v_B(t)} - K_1 \frac{v_{SC}(t)\bar{v}_B}{v_{FC}v_B(t)} - K_2 \frac{v_B(t)}{v_{FC}} \right) - K_1^2 \frac{\bar{v}_B \tilde{v}_B(t)}{C_{SC}v_{FC}}$$

where $\dot{v}_B(t) = -(\tilde{i}_L(t) + K_2 \tilde{v}_B(t) + K_1 \tilde{v}_{SC}(t))/C$

The proposed solution, of first order approximation, assures the equality (10.21) with an error in $O(\delta^2)$. This means that the control solution reproduces the energetic behavior of the continuous-time scheme with an error in $O(\delta^2)$.

10.4.1.1 Simulation Results

Before experimental implementation, a close attention is given to the simulations and the analysis of these results. In this study the object of these simulations is to evaluate how the sampling period affects the systems performances and secondly how the new digital controller improves the performances of the emulated controller (implemented with ZOH block). This simulation does not focus on the continuous-time results which are discussed in the referred papers.

The parameters and the constraints of the model used in the Simulink scheme are identified from the physical system available at the LGEP.

A problem that arises, when implementing the proposed controllers, is due to the fact that the R_l (load resistor) is unknown. Previous studies [Ghanes *et al.* 2011],[Tiefensee *et al.* 2010a] showed that when considering a constant value for the load resistance, when increasing the load, during the experiment's run-time, the SCs voltage is not regulated to its reference value. In such a situation, SCs

provide more energy that is needed, during the power transition, and SCs leading is uncertain. But on the other hand the regulation of the v_b is achieved.

To solve this situation, two solutions have been proposed: the first one is based on the estimation of the R_l and the second one adds an integrator to the command $u_1 = i_{fc}^*$.

THE CASE OF CHARGE ESTIMATOR In this paragraph a load estimator is described and represents a way to deal with this problem. The impedance ($Y_k = 1/R_{lk}$) of the load is estimated as follows:

$$Y_k = e^{-K_{Rl}\delta} Y_{k-1} + (1 - e^{-K_{Rl}\delta}) \frac{i_{lk}}{v_{bk}} \quad (10.25)$$

where the tuning parameter K_{Rl} imposes the speed of the convergence of the estimator. The sampling period δ is used for the digital implementation. To guarantee that the fuel cell current has a slow variation one imposes constraints on the K_{Rl} parameter. In the following simulations, the value selected for K_{Rl} gives a slow time response, so that the FC current reference react smoothly.

THE CASE OF THE INTEGRAL ACTION When designing the control laws, some physical elements have not been taken into account (for example the fuel cell voltage dependency on the temperature). In practice, such elements, and other non-modeled dynamics can influence the controllers' performance. So a integral action needs to be added to the passivity controller in order to ensure zero SCs voltage error at steady state. The extended controller is given next:

$$\dot{u}_i = \gamma \tilde{v}_{SC}; \gamma > 0 \quad (10.26)$$

$$u_{c1}(t) = \frac{v_B(t)}{v_{FC}} \left(\frac{\bar{v}_B}{R_l} + (K_1 \frac{v_{SC}(t)}{v_B(t)} - K_2) \tilde{v}_B(t) - K_1 \tilde{v}_{SC}(t) + C u_i \right) \quad (10.27)$$

$$u_{c2}(t) = -K_1 \tilde{v}_B(t) \quad (10.28)$$

The tuning parameter γ is chosen so that the evolution of the FC current be smooth.

The tuning parameters of the controller can be adequately chosen by means of simulations (try and error loops) since theoretical analysis is too tedious to be carried out.

The next simulations are considered for the power load as given in [Figure 10.4](#). The R_l value is adjusted continuously by using the estimator recalled in paragraph [10.4.1.1](#).

In [Figure 10.5](#) are depicted the evolution of the specific variables of the FC/SCs system. The controller gains are chosen as follows: $K_1 = 4$ et $K_2 = K_1 \frac{v_{SC}}{v_B}$, according to the imposed objectives.

The regulation of the bus and SC's tensions are achieved with zero steady state error.

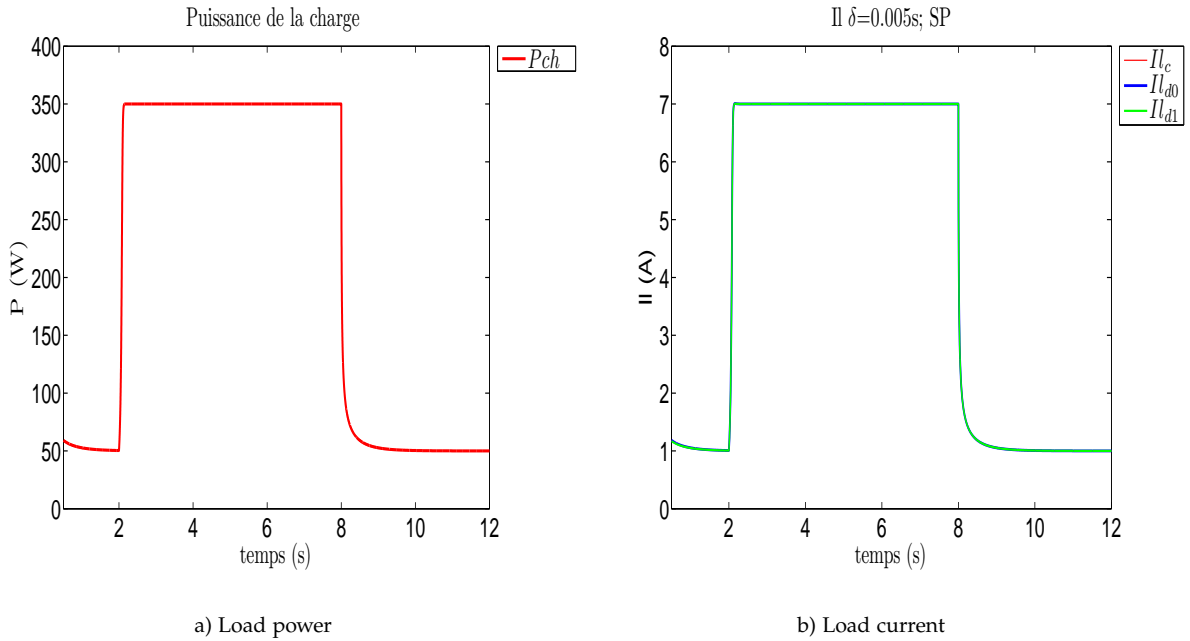

Figure 10.4: The load profile used

For small sampling periods (up to 1 ms) the approximated and the emulated controllers have similar evolutions. The results are depicted for a bigger δ when the differences can be noticed.

In red color the continuous-time evolution is plotted, the emulated controller with blue and the approximated controller with green. It can be noticed that the digital versions offer larger overshoots than the ones obtained for the continuous-time evolution. This degraded performance is most visible for the emulated controller when the overshoot of v_B is 0.2V larger than the one in continuous-time and respectively for i_{SC} with 1.2A. For the FC current and for SC tension the solutions are similar with the continuous ones. The approximated controller offers a good improvement especially for the SCs current (a diminution of the currents amplitude with 0.3A). The tensions evolutions are not significantly improved, by this controller.

10.4.1.2 Experimental Results

The digital controllers have been experimentally validated on a hybrid test benchmark composed of a 46A/1200W Nexa Ballard fuel cell. The transient auxiliary source consists of two Maxwell SC modules associated in series: each module consists of six individual elements interconnected in series [2.7V, 1500F]. This SCs device is interconnected to the DC bus by means of a built in chopper, with standard MOS modules and a switching frequency of the PWM set to 20kHz.

The hybrid power source is connected to a programmable electronic load (Hcherl and Hackl, model ZS1806), which has a rated power of 1800W ($I_{max}=150A/V_{max}=60V$). This load emulates vehicle power consumption, and is directly monitored by the dSPACE DS1103 real-time board. The inner

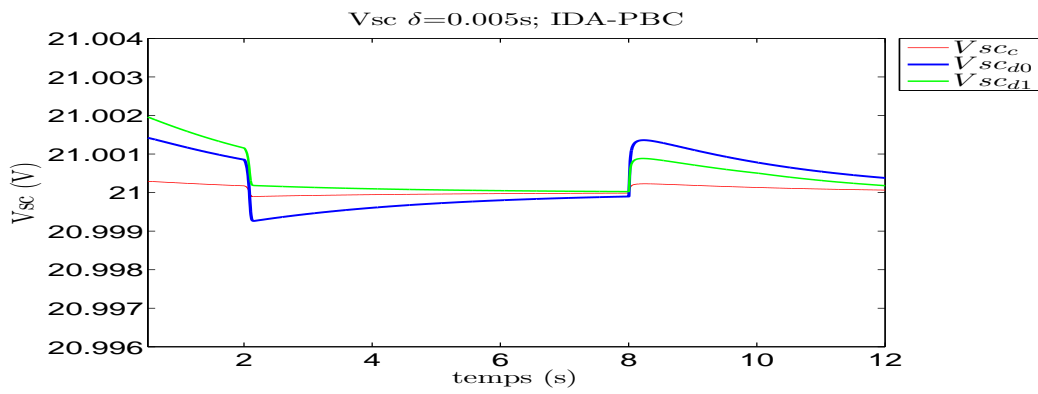

(a) VSC

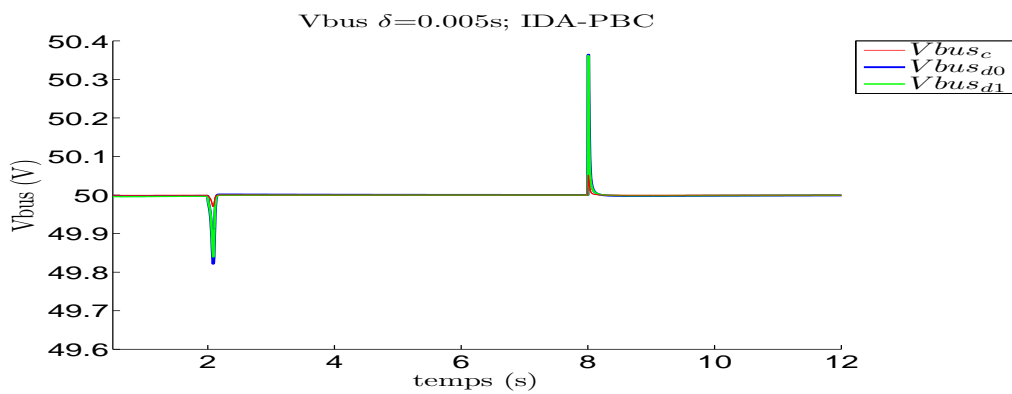

(b) Vbus

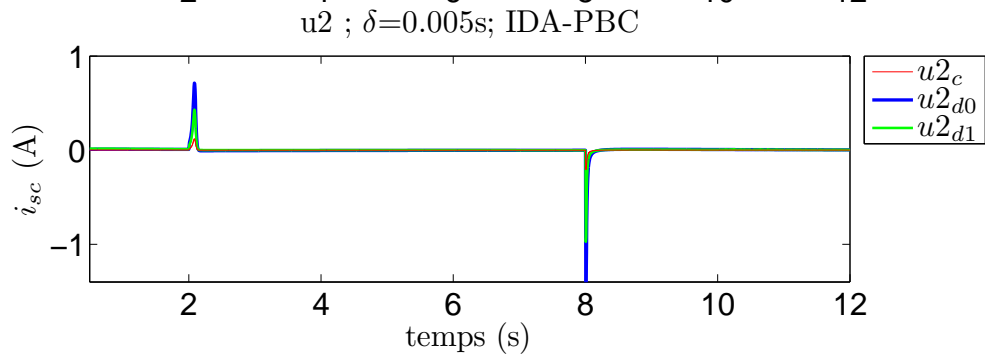
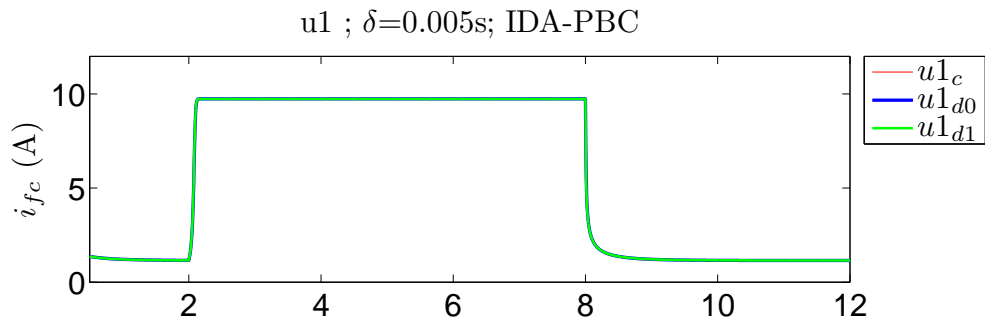

(c) Ifc ; Isc

Figure 10.5: Simulation results for IDA-PBC, $\delta = 5\text{ms}$

currents, which are generated in function of the duty cycle value, are adapted by means of two digital PI controllers updated at 20kHz. In the appendix, [Chapter 15](#), in [Table 15.1](#) there are summarized the electric characteristics of the FC/SCs system.

In the following figures, 3 controllers are plotted:

- with **red** there is depicted the emulated controller with $\delta = 500\mu\text{s}$; It is referred to as 'continuous' controller in the referred papers;
- with **blue** there is depicted the emulated controller with $\delta = 1$ or 3 ms.
- with **green** there is depicted the approximated controller with $\delta = 1$ or 3 ms.

The reference DC bus voltage is set equal to 50V, and the load current varies between 0 and 15A. Note that the DC bus and SC voltages are well regulated in spite of the very fast dynamics of power demand. Each time the power load varies, the SC current is positive (respectively negative) during an increase (respectively decrease) of the power load. In such situation, the SC voltage continuously fluctuates around its constant reference value V_{SC}^* set to 21V. Compared to the results obtained in simulation, here we can note that the SC voltage is not equal to its reference at steady state. This is due to the FC converter losses. The gain of the controllers are taken as follows: $K_1 = 10$ and $K_2 = K_1 \frac{V_{SC}}{V_B}$.

In [Figure 10.6](#) the results are obtained when using an estimator for R_L with $K_{R_L} = 0.5$ for a sampling rate equal to 1ms. In [Figure 10.8](#) the results depicted are obtained under the same conditions, but for a sampling period equal to 3ms. In [Figures 10.7](#) respectively [10.9](#) there are plotted the same variables, but when adding an integrator to the controller (in the place of the estimator).

In each figure, there are given the evolutions of the load current (a), the tension of the SCs (b), the load impedance (c), the tension of the bus (d), the fuel cell tension (e) and the currents of fuel cell and of the SCs (f). The same conclusions drawn in the simulation case can also be stated for the experimental results: the emulated controller offers a degradation of the continuous-time controller, in terms of bigger amplitudes of the principal variables: bus voltage and SCs current. Secondly, the first order approximated controller offers small contraction of these amplitudes especially for the SCs current. For the bus voltage, this controller does not give improvements. These aspects can be observed for both cases, either by using an estimation for R_L or either by using an integral action. For $\delta = 3\text{ms}$ it can be observed that the bus tension is degraded when using the first order controller. This can be explained by the fact that, in this case, the controller amplifies the noise that is captured from the measures (due to the fact that this controller has a derivative component).

Also it must be taken into account the fact that the performances of the sampled-data controllers depends on the gains of the continuous-time controller (as shown in the first part of the thesis). In this setting, the gains which are chosen are not too large, in order to induce a slow variation for i_{FC} , and

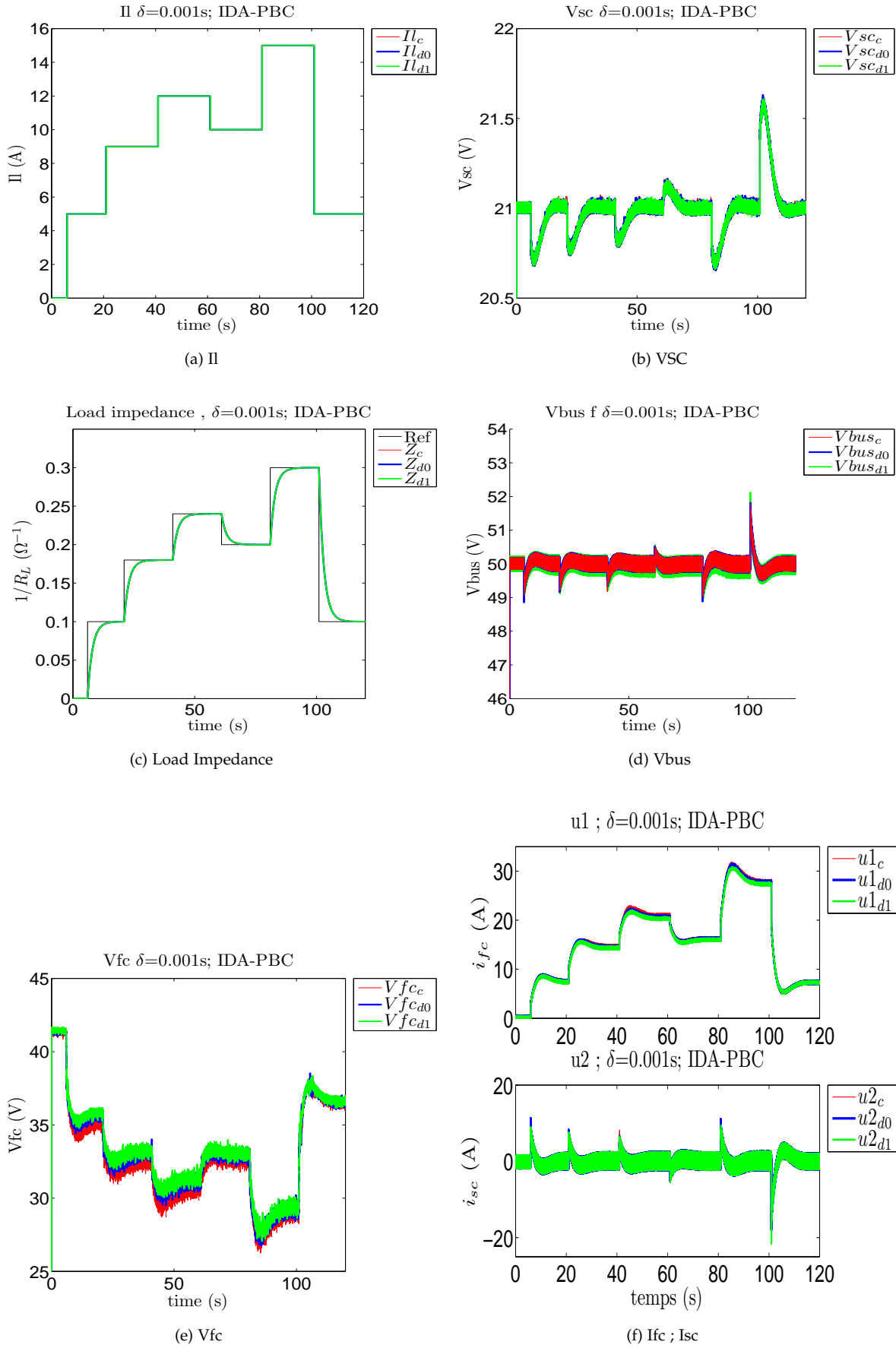

Figure 10.6: Experimental results for IDA-PBC, $\delta = 1ms$, with integral action

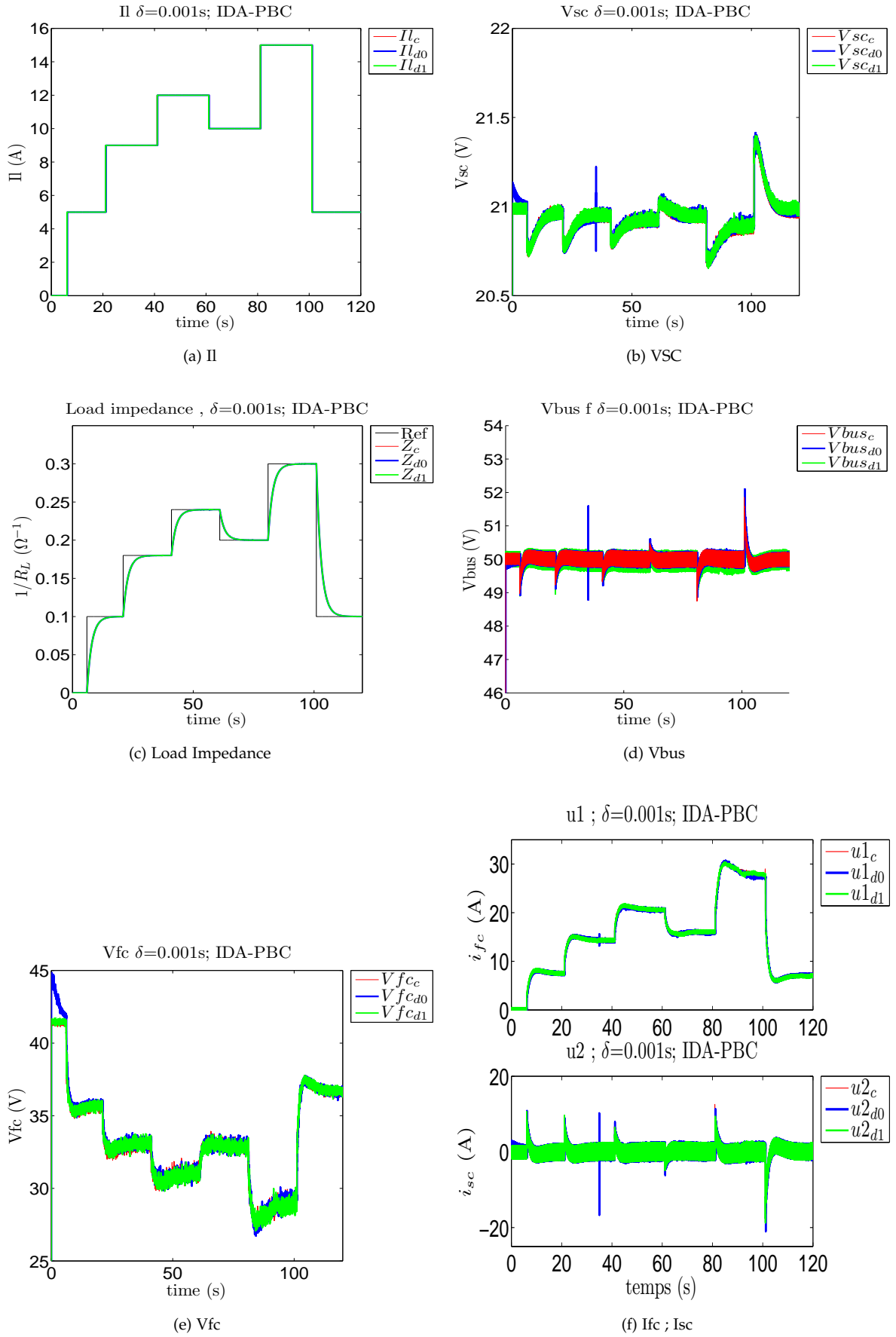

Figure 10.7: Experimental results for IDA-PBC, $\delta = 1\text{ms}$, with estimator

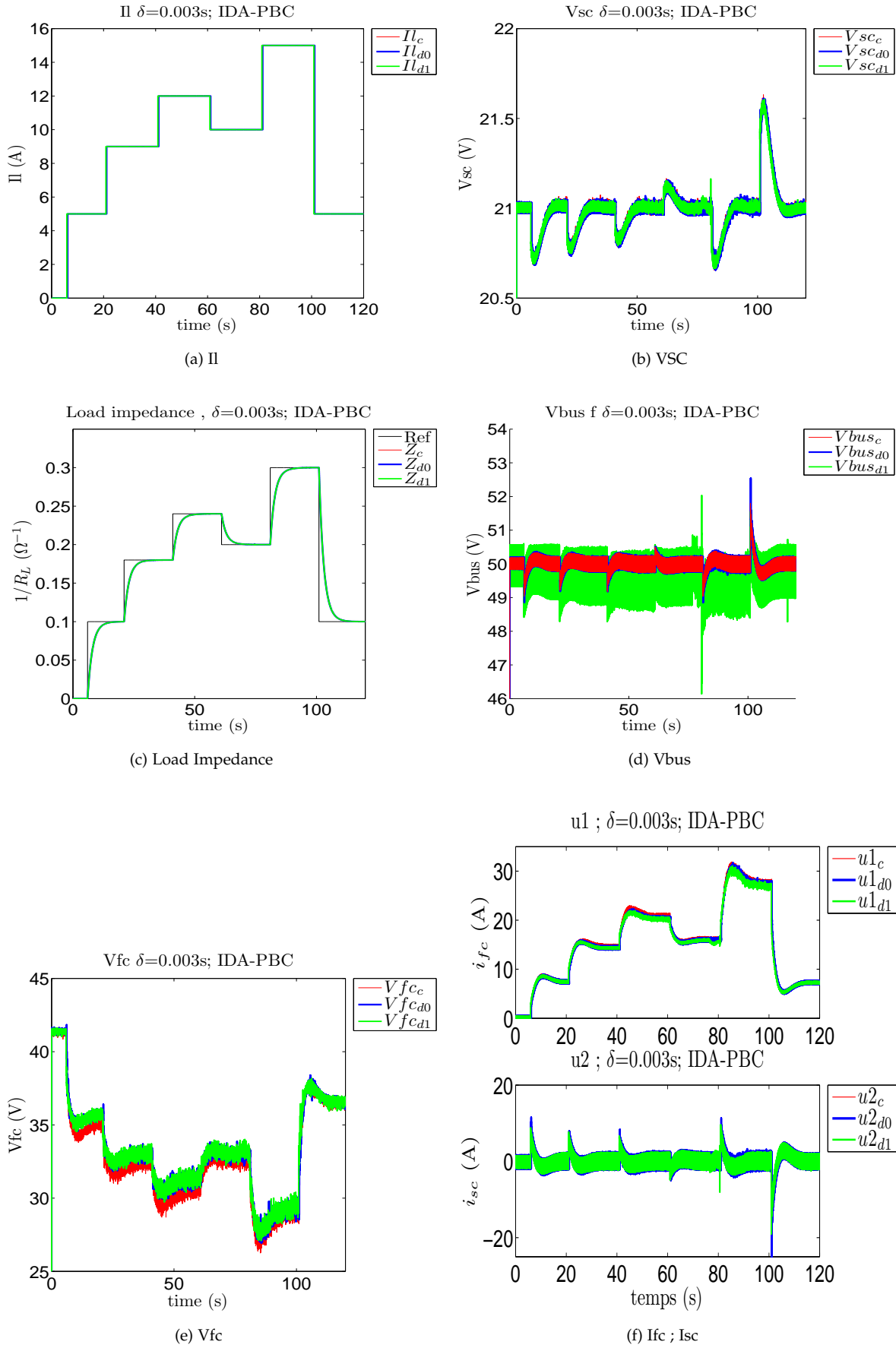

Figure 10.8: Experimental results for IDA-PBC, $\delta = 3ms$, with estimator

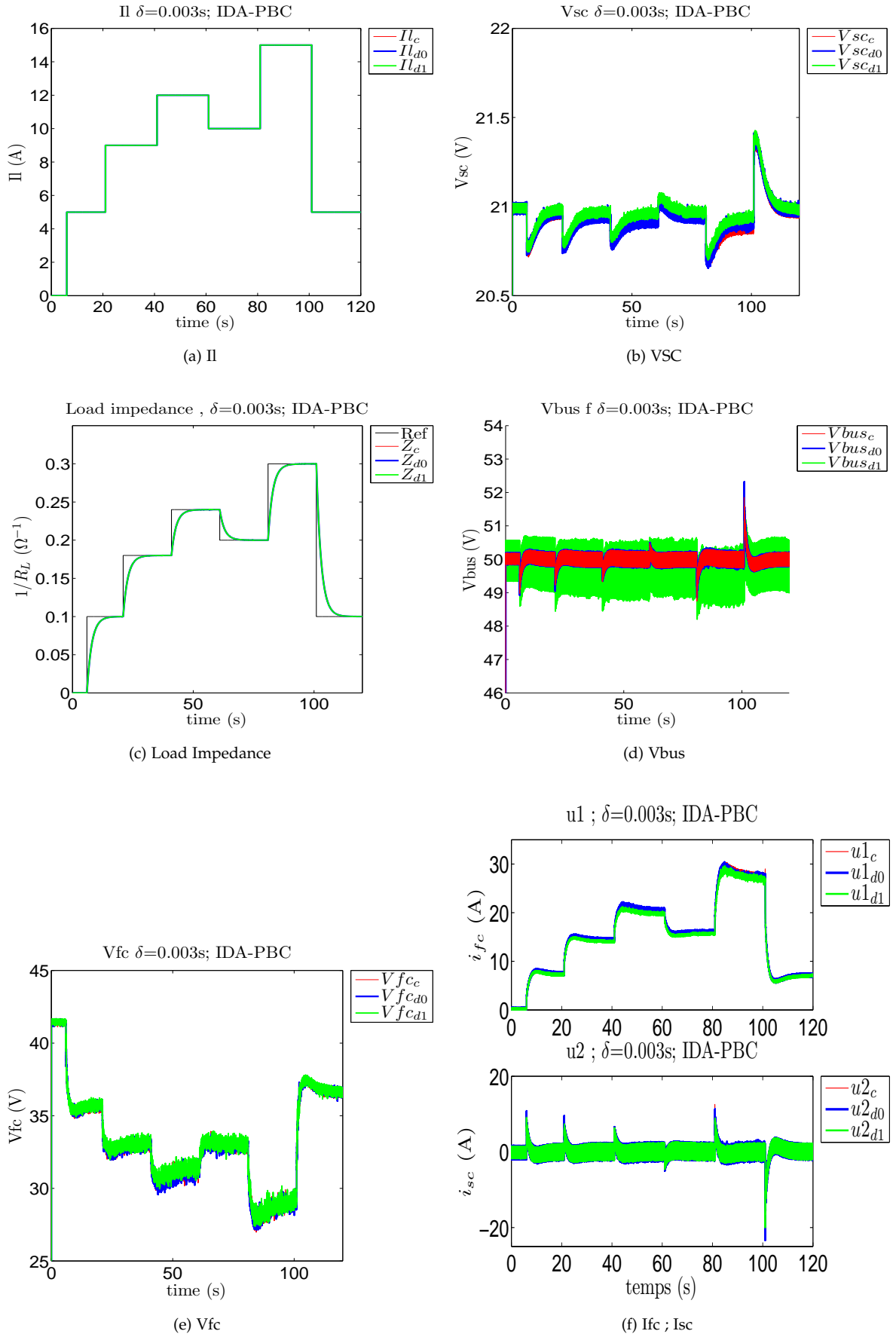

Figure 10.9: Experimental results for IDA-PBC, $\delta = 3\text{ms}$, with estimator

this permits having a certain maximum sampling period of the order of milliseconds. If the gain of this controller is larger, then the maximum sampling period for implementing the digital controllers is reducing (below 1 millisecond).

10.4.2 Singular Perturbation design

In this context the design of the digital controller is accomplished by making reference to the concept already detailed in the previous chapters - the input/Lyapunov matching. This means that the designed controller will preserve the stabilization properties established by the continuous-time controller.

By preserving the same notations as in [Section 10.4.1](#), the aim of the digital controller is to reproduce the evolution of the continuous-time Lyapunov function, at each sampling instant, i.e. the digital controller u_k must satisfy:

$$V(x_{k+1}) - V(x_k) = \int_{k\delta}^{(k+1)\delta} \dot{V}(x_c(\tau)) d\tau. \quad (10.29)$$

In the same manner, the term $V(x_{k+1})$ can be computed from $V(x_k)$ as:

$$V(x_{k+1}) = e^{\delta(f(\cdot)+g(\cdot)u_k)} V(x)|_{t=k\delta} \quad (10.30)$$

where $f := \left[-\frac{x_3}{C}, 0, -\frac{R_1 x_3 + x_1}{L_1} \right]^T$ is the vector field of the autonomous evolution of the system and

$g := \begin{bmatrix} \frac{v_{FC}}{x_1 C} & \frac{x_2}{x_1 C} \\ 0 & -\frac{1}{C_{SC}} \end{bmatrix}$ the one corresponding to the forced evolution.

The digital controller u_k is computed from equation (10.29) and the solution is described by a series in terms of δ around the emulated controller $u_{d0} = u_c|_{t=k\delta}$ as follows $u_k = u_{d0} + \sum_{i \geq 1} \frac{\delta}{(i+1)!} u_{di}$. The exact solution corresponds to the asymptotic development. For practical reasons approximated solutions of order 1 or 2 are used with satisfactory performance. The solution that is proposed, is given for a 1st order approximation with an error $O(\delta^2)$:

$$u_{k1}^\delta = \left(\frac{v_B(t)}{v_{FC}} I_{lm} - \frac{C_{SC}}{T_{lent}} \tilde{v}_{sc}(t) \right) |_{t=k\delta} + \frac{\delta}{2} u_{d11} \quad (10.31)$$

$$u_{k2}^\delta = \frac{v_B(t)}{v_{SC}(t)} \left[-\frac{C \tilde{v}_B(t)}{T_{rapide}} - \frac{v_{FC}}{v_B(t)} \left(\frac{v_B(t)}{v_{FC}} I_{lm} - \frac{C_{SC}}{T_{lent}} \tilde{v}_{SC}(t) \right) + I_L(t) \right] |_{t=k\delta} + \frac{\delta}{2} u_{d21} \quad (10.32)$$

with

$$\begin{aligned} u_{d11} &= \left(\frac{u_2}{T_{lent}} - \frac{I_{lm}}{v_{FC}} \frac{\tilde{v}_B(t)}{T_{rapide}} \right) |_{t=k\delta} \\ u_{d21} &= u_2 \left(\frac{u_2}{v_{SC}(t) C_{SC}} - \frac{\tilde{v}_B}{v_B(t) T_{rapide}} \right) |_{t=k\delta} + \\ &+ \frac{v_B(t)}{v_{SC}(t)} \left(-\frac{\tilde{v}_B(t)}{T_{rapide}} \left(\frac{v_{FC}(t) u_1(t)}{v_B^2(t)} - \frac{C}{T_{rapide}} \right) - \frac{v_{FC} u_{d11}}{v_B(t)} \right) |_{t=k\delta} \end{aligned}$$

The proposed solution assures the equality (10.29) with an error in $O(\delta^2)$. This means that the control solution reproduces the stabilizing properties of the continuous-time scheme with an error in $O(\delta^2)$.

10.4.2.1 Simulation Results

The same setup used for the simulations of the IDA-PBC controllers (as in section 10.4.1.1) is used in the case of SP controllers. The load demanded is pictured in Figure 10.4, and the time parameters of the controllers are $T_{\text{rapide}} = 0.05$ and $T_{\text{lent}} = 2$, chosen in such a way that the dynamics of FC/SCs system be close to the one obtained when applying the IDA-PBC strategy.

The evolutions of the principal variables are plotted in Figure 10.10.

The results show that the sampling reduces the performance of the continuous-time controller. The first order controller, designed to correct this situation, brings in this case an important improvement especially for the bus voltage regulation. The improvements for the SCs current are not significant. It is interesting to note that this approach is complementary in some sense with to IDA-PBC. The first order controller does not contribute to reducing the peaks of the i_{SC} (as the IDA-PBC), but notably reduces the peaks of the v_B .

10.5 CONCLUSIONS

In this chapter the problem of energy management of a FC/SCs system was tackled in the context of sampled-data controllers. The sampled-data design, proposed here, is based on the objective of preserving the continuous-time properties under sampling. Hence, the sampled-data controllers are designed starting from the continuous-time solutions previously proposed in the literature. The performances of the sampled-data controllers are compared with the emulation solution (which is implemented with ZOH devices). For the IDA-PBC version, experimental results were obtained and analyzed in this chapter. For the SP version the experimental evaluation is planned.

The conclusions can be summarized as follows:

- when increasing δ or the gain of the controller, the performance of the emulated controller is reducing;
- the first order controller approximation has proven to offer important amelioration compared to the emulated controller, in terms of reducing the peaks of the principal variables : v_B (in the case of SP) and i_{SC} in the case of IDA-PBC;

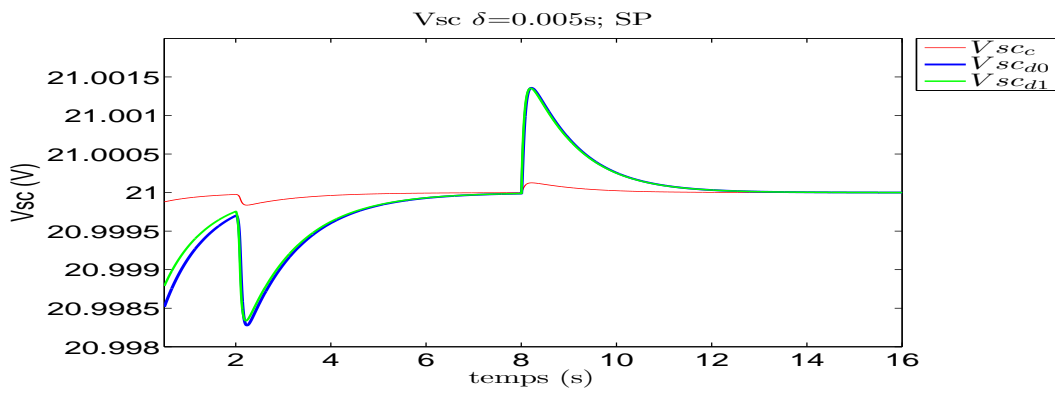

(a) VSC

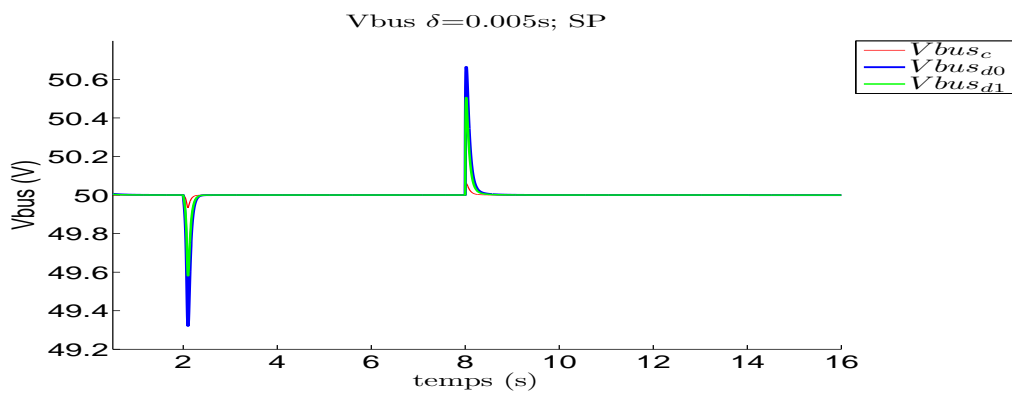

(b) Vbus

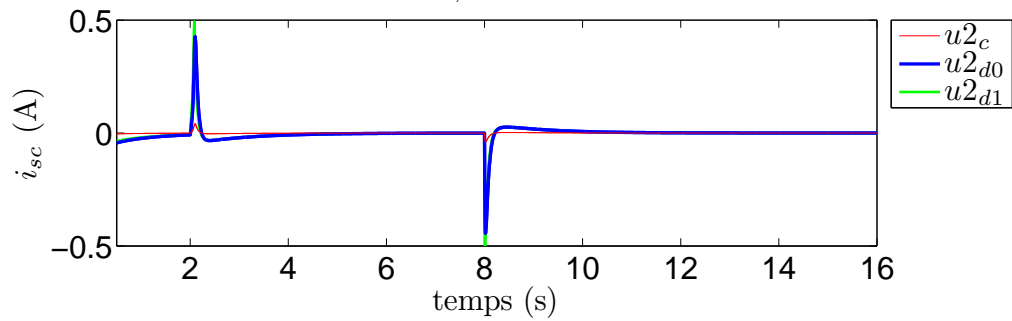
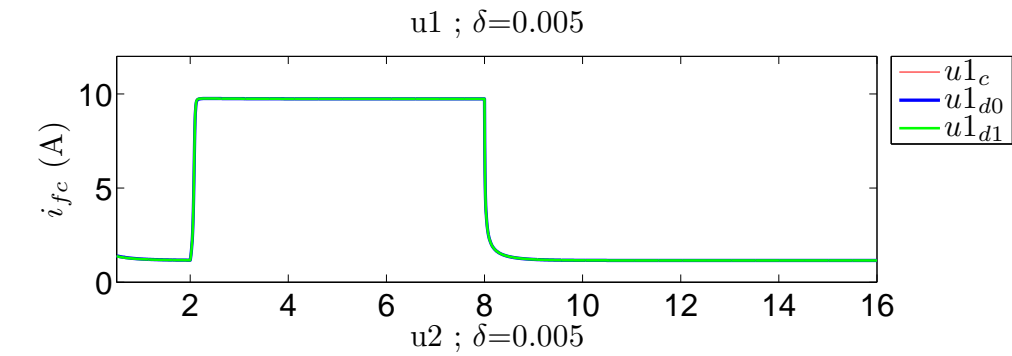

(c) Ifc ; Isc

Figure 10.10: Simulation results for IDA-PBC, $\delta = 5\text{ms}$

- the experimental results are consistent with the ones obtained in simulations; close attention should be paid to the noise measurement;
- the experimental setup permits, by means of the acquisition card, lower sampling periods, for which the emulated solutions are satisfactory;
- the a first order controller sensitivity to the noise measurements was noticed, especially when the sampling period increases;
- the sampled-data controller performances also depends on the settings made in continuous-time; a fast controller designed in continuous-time, will reduce the performance of the digital controllers;

The work is still in progress, in the direction of finding new digital design for such systems. The idea is to improve the performance of the proposed controllers by taking into account the following facts:

- the multiple time-scale characteristic of the FC/SCs system;
- the presence of the noise in the measures;
- the fact that the converters are not ideal and the energetic loss is affecting the V_{SC} regulation;

QUANTIZATIONS EFFECTS ON DIGITAL BACKSTEPPING CONTROL

This chapter deals with the problem of evaluating the effects of quantization on a nonlinear sampled-data control system. The control strategy relies on the digital backstepping design proposed in [Chapter 4](#). The control solution comprises heavily nonlinear expressions and to study the effects of quantizations is mandatory. This analysis captures the contributions of the controllers gain, of the sampling period, of the degree of the controllers approximations and of the numerical precision in the performance of the sampled-data controller. It represents a first attempt and opens a series of discussions for further analysis.

The chapter is organized as follows: section [11.1](#) introduces the problem of quantization in digital control systems; an analysis of quantization errors based on the literature survey for linear and nonlinear systems is given in [Section 11.2](#); in [Section 11.3](#) an academic example is discussed; simulations results are given in [Section 11.3.1](#). Part of the results reported here are included in the paper [S2] from the author's contribution list (page [ix](#)).

11.1 NUMERICAL ISSUES IN DIGITAL CONTROL

When implementing a digital controller on a physical device, the finite number representation is a source of errors that may be critical. The finite representation determines that for each real number a rational number (with a finite number of bits) to be assigned. The number of bits that a device offers for the numerical representation is called *precision* and the operation of assigning the approximated values is called *quantization*. In digital control structures, micro-controllers or microprocessors with 8, 16, 32 or 64 bits precision are usually met. In a software program there can be defined the floating numbers with a single or double precision (8 or 16 bits). On other platforms, especially scientific, the single and double precisions are implemented on 16 respectively 32 bits.

The sources of the quantization errors are mainly the consequence of three factors:

- the analog-to-digital (A/D) converter - where the continuous-time values of the process measures are quantized. The quantization error is lower than 2^{-C} , with C the precision of the converter;
- the controller device - where the coefficients of the control law expressions have also to be quantized;
- when performing the arithmetic operations on quantized signals and coefficients.

Related to the arithmetic used for implementing these digital control laws, the most used are the binary *fixed-point* and *floating-point* arithmetic. Other representations are possible such as logarithmic or residue representations [Hanselmann 1987]. The fixed-point representations, widely adopted in the case of FPGA devices and in some cases of micro-controllers, allow a fixed range of numbers but have the advantage that the quantization errors are introduced only in multiplications and not in addition [Santina & Stubberud 2005].

For floating-point arithmetic, larger range of numbers are possible, with the same number of bits. In this case the quantization errors can be generated both in addition and in multiplication.

Another important aspect is given by the way the numbers are quantized. There are two ways to obtain the quantized number. The first option is to truncate the real number, ignoring the last less significant bits - *truncation error* or round the number to the nearest numeric value that can be represented on n bits - *roundoff error*. The maximum amplitude of the truncation error is double than the amplitude of the roundoff error, and for this reason, the second solution is widely implemented in the digital control. In our analysis the roundoff error will be considered further on.

The representation error can be defined as an absolute error : $\epsilon_a = |x - x_q|$, where x is the real number and x_q is the quantized number. For the case of the roundoff error one gets $\epsilon_a \leq q/2$, where q is the *quantum* or the *resolution*. Also the relative error can be defined as $\epsilon_r = \epsilon_a/|x|$.

11.2 ANALYSIS OF QUANTIZATION ERRORS IN DIGITAL CONTROL

A significant number of papers deal with the problem of evaluating the contributions of the quantization errors in digital linear systems and fewer dedicate this problem to the nonlinear case. In the next lines some conclusions about quantizations on linear controllers are drawn, based on the literature survey.

11.2.1 The linear system case

Earlier studies on quantizations of linear sampled-data systems are given in [Bertram 1958], [Tou 1959], [Monroe 1962], [Widrow 1960] or [Slaughter 1964]. Based on these works, in [Franklin *et al.* 1998] there are summarized 3 models that can be used to analyze the effects of the roundoff error. The first one, which is due to Bertram [Bertram 1958] is known as *the worst-case error bound*. In this analysis, the most pessimistic case is considered when the roundoff errors occur in a way to cause maximum harm. The Bertram's worst-case bound can be used to state that the output error will not grow beyond this bound. Another conclusion that is depicted, is that if the linear system is stable then also the system with quantization is also stable.

Another model used is the *steady-state worst case* proposed in [Slaughter 1964]. In this approach the analysis is carried out when the system is in steady state. This approach evaluates how large the errors of the steady-states are as a result of the roundoff. An interesting observation in this case is that the output error bound is depending on $q/2$ multiplied by the static gain of the linear system.

However, the previous models give simpler forms but are often excessively pessimistic. A third solution is to employ a stochastic analysis. The basic idea is that the quantization error is a signal that can be modeled as a white random signal with a probability function uniformly distributed over the range of quantization. Then by applying the stochastic procedure, some estimates of the errors on a linear system can be expressed.

Another aspect studied, is the contribution of the quantization of the controller parameters in the digital devices. The usual approach that can be used here for analyzing the effects of coefficient quantization is referred to as the *coefficient sensitivity analysis*. The main idea is to compare the response differences (called *variations*) of the ideal system with the one with quantized coefficients. The evaluations of these responses becomes difficult for higher order linear controllers and the only solution is the use of simulation tools.

In the last decade the interest for sampled-data systems with quantizers has been renewed due to the success of networked control systems (see [Antsaklis & Baillieul 2004]). But all these works still consider the linear time characterization of the plants. In this context, new solutions have been proposed by employing quantizers with variable precision which are adapted accordingly to the quantized measurements. In this way better stabilization properties can be achieved.

In the end of this paragraph there are summarized some results about quantization effects on linear digital controllers.

- The amount of the error introduced by quantization may depend on the choice of the sampling rate (especially when discretizing continuous-time controllers) [Santina & Stubberud 2005], [Franklin *et al.* 1998], on the type of the system, and on the complexity of the controller considered [Whidborne *et al.* 2006];
- Due to finite word length in the controller may appear *limit cycles* (sustained oscillations) even in the absence of any applied input [Santina & Stubberud 2005]; These limit cycles exist in fixed-point digital controllers but can be ignored in floating-point architectures¹. To alleviate this effect a solution is to add to the input a low amplitude oscillation known as *dither*[Franklin *et al.* 1998].

11.2.2 The nonlinear case

When considering a nonlinear input-affine system with a nonlinear state-feedback controller it is clear that most of the methods recalled for the linear case are not suitable to be used since the superposition principle does not apply.

A qualitative work concerning the stability of nonlinear sampled-data systems with fixed quantizations is conducted in [Hou *et al.* 1997] and for the multi-rate digital control in [Hu & Michel 1999]. Instead of the fact that the nonlinear model is a simpler version of the standard input-affine case and also the fact that a linear controller is considered, this represents a first attempt concerning the stabilization properties of such systems. The results obtained there state that if the linear version of the sampled-data system, without quantization, is asymptotically stable then the nonlinear sampled-data system with quantization is uniformly ultimately bounded. The bound of the solutions can be made as small as desired by making the quantization size sufficiently small.

An idea to handle with the problem at hand is to consider that the quantizations act as a perturbation on the measurements used in the controller computations. In this case we can refer to stochastic analysis.

If one considers the case of a state-feedback controller, constant on time-intervals of length δ , then the perturbed controller can be also expressed as a series expansion around the real state measurements as:

$$u(x_k + \epsilon_k) = u(x_k) + \epsilon_k D_u(x) + \frac{1}{2} \epsilon_k H_u(x_k) \epsilon_k^T + \dots \quad (11.1)$$

where $D_u(x_k) = \left[\frac{\partial u}{\partial x_1} \dots \frac{\partial u}{\partial x_n} \right] |_{t=k\delta}$ is the gradient of the u along the state directions, and $H_u(x)$ is the Hessian matrix of u . It is clear that when dealing with linear state feedback controllers the

¹ It is shown in [Sandberg 1967] that under suitable conditions of the filter coefficients with floating point arithmetics the stability can be ensured in the presence of round-off error, and thus rules out the occurrence of limit-cycle response

$D_u(x_k)$ is a constant which amplifies the quantization error ϵ_k . In the case of nonlinear controllers the series expression order (11.1) is equal to the highest power of the states and a discussion about the quantization becomes an impossible task. As it is often the case in a nonlinear context, some analysis can be done by means of Euler approximations, in this case the *control absolute error* in the presence of quantization can be Euler type approximated as:

$$\epsilon_u = |u(x_k) - u(x_k + \epsilon_k)| = |\epsilon_k D_u(x)| \quad (11.2)$$

It is clear that if one considers the quantization error as a perturbation, the difficult part is to estimate its bound since it depends on the state variables. In the case of perturbed nonlinear systems, many results do exist for continuous or discrete-time systems which underlie on the level sets of suitable Lyapunov functions or in the case of sampling and hold devices, the robustness of the perturbed controller is often analyzed with the help of the notion of input-to-state stability. When the perturbation acts in the inputs measurements a general result is more tedious to be stated. A complete work that handles this problem is [Ledyeva & Sontag 1999]. Anyway these results have not been linked with the quantizations errors due to the fact that in this case the perturbations bound also depends on the state variable.

Other studies have been driven by the idea proposed by Liberzon in [Liberzon 2001] that to attained the equilibrium point a reduction of the quantized error has to be employed. So he has proposed adaptive quantizers and a control solution that comprises also an up-dating policy of the quantizer. This quantizer can be applied only with discontinuous controllers, a continuous-time switching policy is not attainable.

Related to the coefficient sensitivity a study has been performed for the backstepping type controllers in [Poza *et al.* 2008]. In this article the digital controller is designed by using a different methodology based on the adaptive approach. The important conclusion that is drawn there is that the design parameter should be chosen according to the level of precision desired.

In the context of this work, the heavily nonlinear nature of the digital controller and the lack of specific results in the literature make difficult any theoretical analysis of the effects of the quantizations. As the digital controllers are build to satisfy specific stability properties the aim is to estimate the effects of the quantization on the stabilization. In the next sections this analysis is performed by means of simulations tools. The following questions need to be clarified:

- in the presence of quantization errors, how the stabilitz is affected bz:
 - the order of the approximation of the controller
 - the gain of the controller

– the sampling period

- is it possible that quantization drives the system to instability ?

11.3 ACADEMIC EXAMPLE

Let us consider the 2-state system already considered in sections 4.2.1 and 4.5:

$$\dot{x}_1 = x_1^2 + x_2 \quad (11.3)$$

$$\dot{x}_2 = u \quad (11.4)$$

with the state feedback controller

$$u = -2(x_1 + x_2 + x_1x_2 + x_1^2 + x_1^3).$$

The expressions of the controllers for the single-rate and for multi-rate case are already defined in section 4.5.

Let there be considered next, that the states measures x_1 , x_2 are affected by a quantization error ϵ_1 respectively ϵ_2 , with the remark that these values may change at each sampling instants. By using the estimates (11.2) then the error of the emulated controller $u_k^{\delta 0} = u_{d0}$ under the assumptions that $K := K_\phi = K_y$ and $\epsilon := \epsilon_1 = \epsilon_2$, can be expressed as:

$$\epsilon_{u_k^{\delta 0}} = \epsilon|(4K + 2)x_1 + 6x_1^2 + 2x_2 + (K + 1)^2| \quad (11.5)$$

Under the same conditions the first order controller $u_k^{\delta 1} = u_{d0} + \frac{\delta}{2}u_{d1}$ has the error expression:

$$\begin{aligned} \epsilon_{u_k^{\delta 1}} &= \epsilon|(4K + 2)x_1 + 6x_1^2 + 2x_2 + (K + 1)^2 + \frac{\delta}{2}(4(K - 1)x_2 + x_1^2(12K - 4) \\ &+ x_1(10K^2 + 4K - 8x_2 + 2) - 8x_1^3 + 2K^3 + 3K^2 + 2K - 1)| \end{aligned} \quad (11.6)$$

It is clear that by increasing the order of the approximated controller the bound of the control error depends on the powers of the controllers gains and also on the sampling periods. The question is how the stabilization property is affected, i.e. relations (3.15) and (4.68) for the single-rate and multi-rate case respectively, with p the order of the controller approximation, in presence of quantization. After some computations the Lyapunov difference in the presence of quantization is given by

$$V_q(x_{k+1}) - V_q(x_k) \leq \delta\alpha_3(\|x_k\|) + \delta(u_k^q - u_k)L_{g_c}V(x_k) + O_q(\delta^2) + O(\delta^p) \quad (11.7)$$

respectively for the multi-rate case:

$$\begin{aligned} V(z_{k+1}, y_{k+1}) - V(z_k, y_k) &\leq \frac{1}{2} \left(-\delta(\rho_W(|z_k|) + \rho_y(|y_k|) + \rho_V(|z_k|, |y_k|)) + \delta(u_k^q - u_k)L_{g_c}V(x_k) \right. \\ &+ \left. O_q(\delta^2) + O_W(\delta^{p+2}) + O_y(\delta^{p+1}) + O_V(\delta^{p+1}) \right) \end{aligned} \quad (11.8)$$

It is thus clear that the stabilizing performance can be affected by the presence of the quantization errors. The previous observations suggest that in presence of quantizations, the expected stabilizing property will refer to practical stability (see [Section 2.1.1.1](#) and [definition 26](#)). This means that the states ultimately enter a ball with a specific radius that could not be estimated. By increasing the precision this ball can be reduced to lower radius.

11.3.1 Simulation results

As it was mentioned before, the theoretical methods do not easily give precise estimations of the quantization effects on a sampled-data system. From the previous expansions it is not clear if by increasing the order of the approximated controller the errors will increase and as consequence will destabilize the system. Also, as it was pointed out in the referred papers, by increasing the gains of the controller there will be introduced more errors into the system. This was clear the case for linear systems, but in the non-linear case the quantization error is multiplied not only by the gains but also by the state variables, which should converge to 0. For these reasons the aspects that were evaluated by means of simulation are:

- the effects of increasing the gain of the controller $K := K_\phi = K_y$;
- the effects of the sampling rate;
- the effects of increasing the order of the controller approximation;

All these effects are evaluated from the Lyapunov matching point of view, by using the same error criteria as in [Chapter 5](#), which count for all the absolute mismatches between the sampled-data and the continuous-time evolutions of the Lyapunov function at each sampling instant, for a fixed time length simulation.

sampling period	initial conditions	gains	simulation time length	Figure labels
$\delta \in [0.01, \dots, 0.3] \text{ s}$	$x_0 = [0.5 \ 0.5]$	$K \in [0.1, \dots, 10]$	$t_f = 10 \text{ s}$	Figure 11.1 , 11.2 , 11.3

Table 11.1: Numerical values of the simulation parameters- Example 2 with quantization

The simulation parameters are given in [Table 11.1](#). The quantization error has been introduced in the simulation by considering that the state measures are quantized by rounding to a fixed point representations having the word length 8 bits and the fraction length equal to 5 bits. In the controller

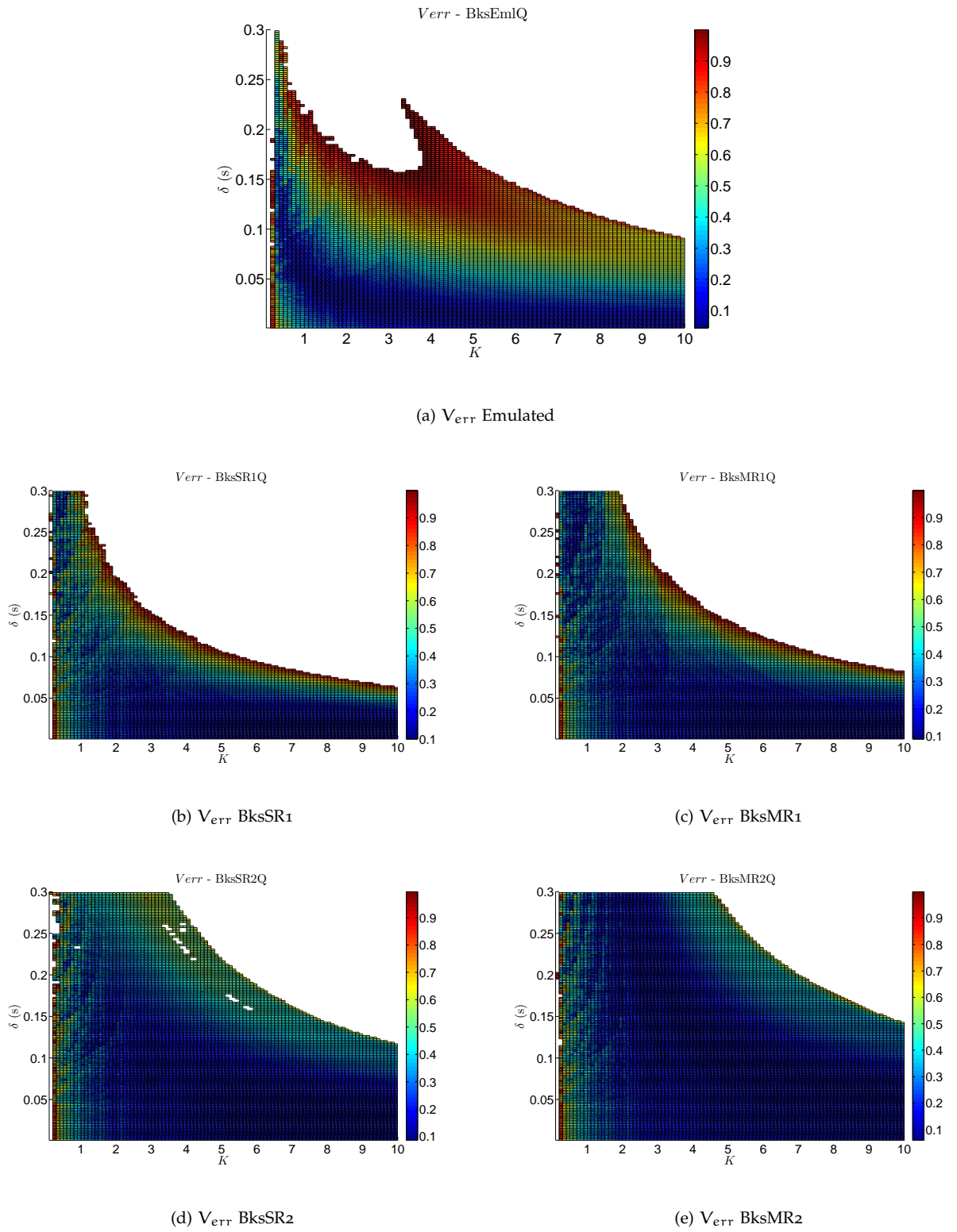
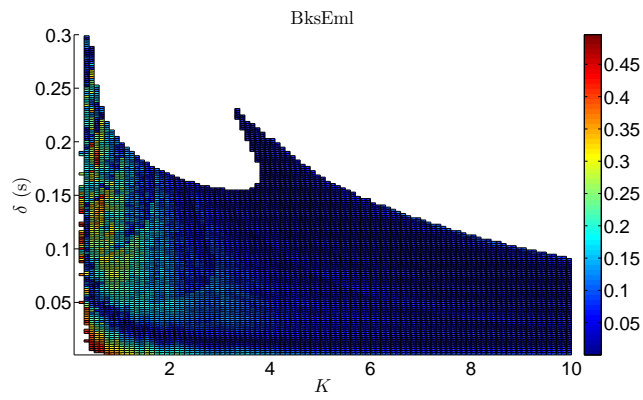
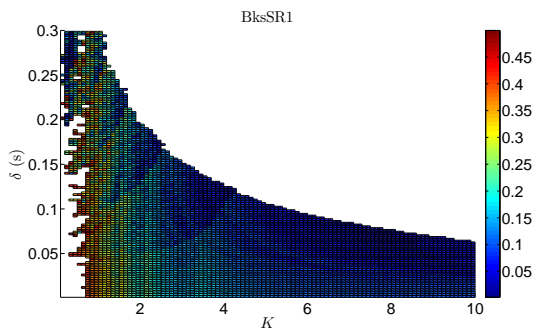

Figure 11.1: Lyapunov matching error with quantized controller



(a) V_{err} Emulated



(b) V_{err} BksSR1

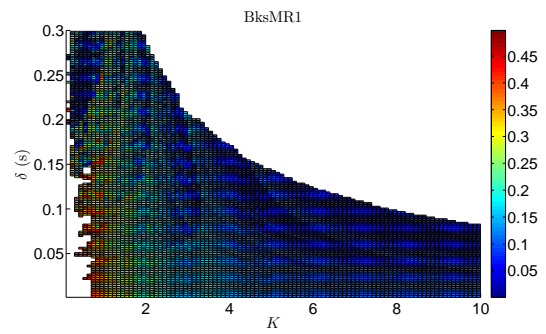

(c) V_{err} BksMR1

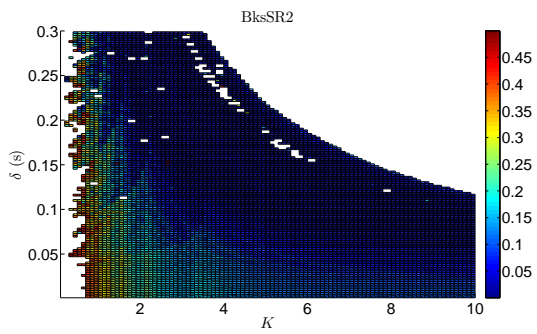

(d) V_{err} BksSR2

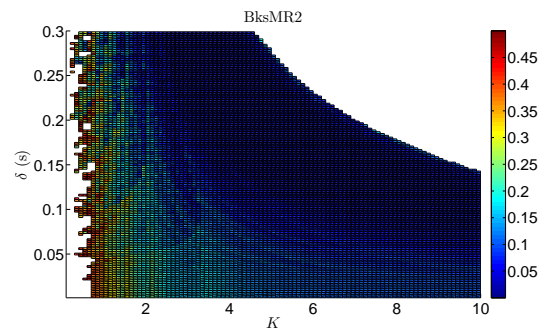

(e) V_{err} BksMR2

Figure 11.2: Lyapunov matching error difference between the ideal and quantized controller

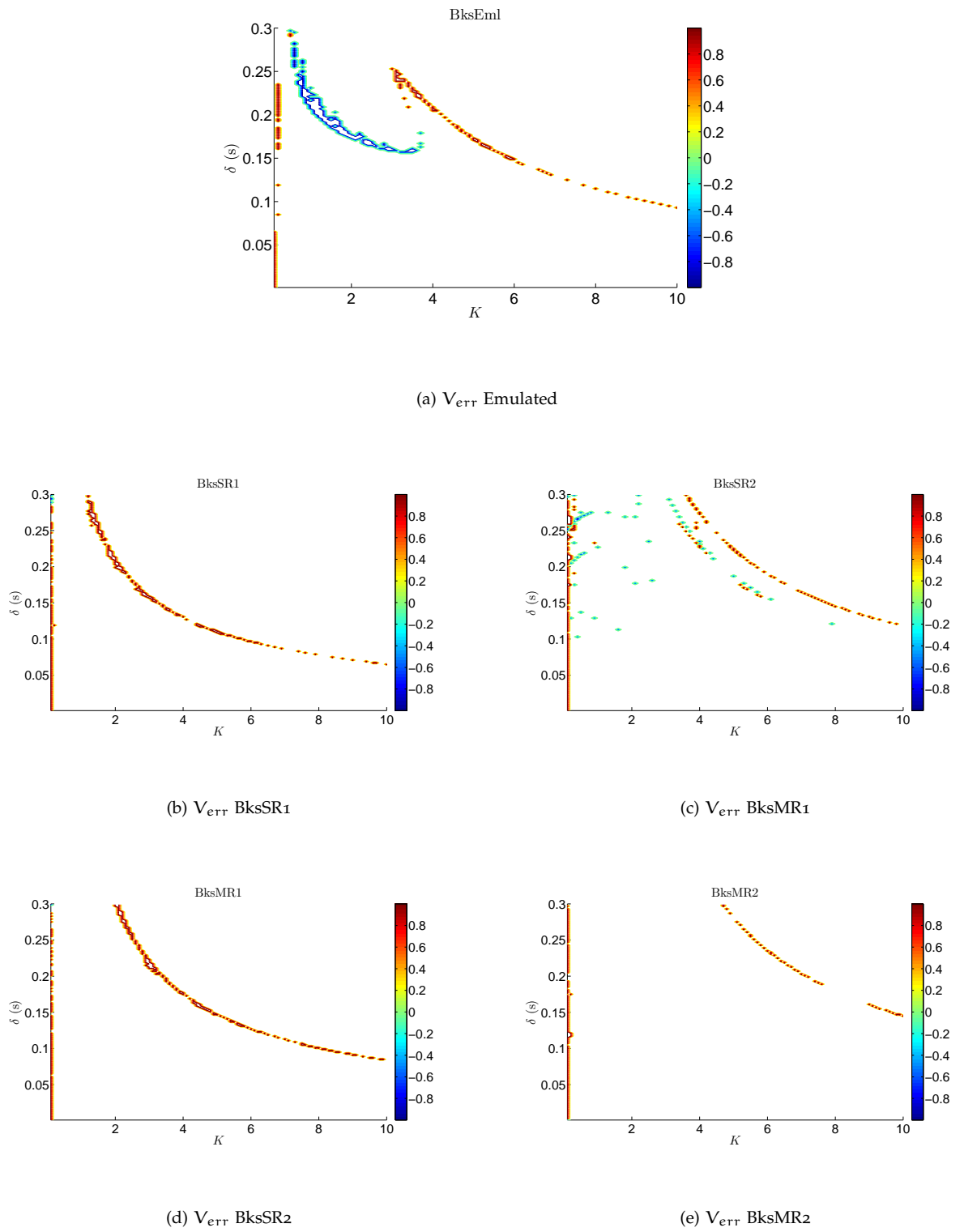

Figure 11.3: Lyapunov matching error difference between the ideal and quantized controller

Case	Criteria	BksEml	BksSR1	BksSR2	BksMR1	BksMR2
1	Err_M	519.02	948.59	840.54	1125.1	1080.5
1	S_{err}	7744	6577	10608	8352	11911
1	R_{err1}	0.067	0.144	0.079	0.135	0.091
2	Err_M	586.90	997.07	879.01	1198.7	1104.3
2	S_{err}	7665	6348	10424	8166	11682
2	R_{err1}	0.076	0.157	0.084	0.147	0.095

Table 11.2: Errors criteria

device the computations are performed with double and floating point precision. In this way the study is performed in order to quantify only the effects of the quantization that is due to the A/D converter. A second case study is made, by considering that some parameters of the controllers are also quantized with the same precision - labeled "Case 2" in Table 11.2.

The simulation results, by considering only the converter's quantization are illustrated in Figure 11.1. In Figure 11.1 there is evaluated the error criterion (5.1) for the given ranges for K and δ in the presence of quantizations. For each controller tested : the emulated version "BksEml", the first and second order approximated controller "BksSR1" and "BksSR2", respectively for the multi-rate versions "BksMR1" and "BksMR2"- the reduced errors levels (blue) mean that the stabilization property is close to the one of the continuous-time. Increased values mean that stabilization is degraded. These results show that the digital design, especially, the second order controller improves significantly the stability performance that was obtained by means of the emulated controller. When increasing the gain of the controller, the system's response is faster and the maximum admissible sampling period is reducing. From these simulations it is clear that the effects of quantization are not negligible. The same simulations have been conducted in the case of free quantizations in Section 4.5, Figure 4.6. To show better the differences between these cases, in Figure 11.2 there are depicted the Lyapunov error differences between the ideal and quantized scheme. Another interesting result is given in Figure 11.2 which offers some responses to the following questions:

- i) Are there situations when the ideal control system is stable and the quantization destroys this property ?
- ii) Are there situations when the ideal controller is unstable but the quantization renders it stable ?

The situations that answer to the first question are depicted in the indicated subfigures by the red colored regions, and for the second question the blue colored regions. The analysis of these plots indicates that these situations occur especially in border regions, where the sampling period or the gains are at their maximum admissible values.

In [Table 11.2](#) there are quantified the errors due to quantization by using the following formulas:

- $\text{Err}_M := \sum |\Delta V_{SQ}|$ - is the cumulative sum error of the Lyapunov ideal vs the quantized - difference depicted in [figure 11.2](#);
- S_{err} counts for the area of the surface $K\delta$;
- $R_{\text{err}} = \text{Err}_M / S_{\text{err}}$ is the relative error;

By analyzing these values (see [Table 11.2](#)) it can be observed that the emulated control offers the slowest level of quantization errors. By increasing the order of the controller, which leads to large expressions, this does not necessarily increase the quantization error level, as intuition suggests. In fact, the simulations show that, the first order controller is more sensitive to quantizations while the second-order controller has a better robustness. The multi-rate versions offer larger stability areas and consequently the quantization cumulative error is increasing.

By analyzing the second case from [Table 11.2](#) where the quantization errors on the controller coefficients are also taken into account, the levels of errors are greater. The second source of errors, the quantization of the controller coefficients, amplifies the contribution given by the A/D converter quantizations.

11.4 CONCLUSIONS

In this study the quantizations effects have been highlighted and discussed on the digital backstepping design that was proposed in [Chapter 4](#). A survey on the actual realizations on this topic has been done here and the conclusion is that in the case of nonlinear controllers theoretical results cannot be provided to state precisely how the quantization can affect the stabilization of the sampled-data controlled systems. A suggestion is to consider the quantization as a perturbation input to the system, but the problem that remains to be solved is how to handle such a perturbation when the bounds cannot be computed explicitly and also the model of the perturbation is difficult to be derived.

Complex and multiple simulations have been conducted to evaluate practically the influence of the quantization on the control strategy proposed. The conclusions that can be drawn are:

- The simulations show that for small δ , the controllers are more sensitive to quantization errors (which is coherent with the results from the linear case). This aspect is in favor of the controller proposed in [Chapter 4](#) which are developed for admitting larger sampling periods.
- The second conclusion concerns the sensibility of the higher order controllers (single or multi-rate) to quantization errors. As intuition suggests, the computations of more complex control expressions make the control solution more sensitive. However, as reported in [Table 11.2](#) we notice that the relative error R_{err1} computed for the second order controller (single or multi-rate) is still admissible and comparable with the error obtained for the emulated case. It results that the proposed controller perform better with respect to stabilization and keep admissible robustness with respect to quantization error.
- Some situations have been highlighted where the quantization can improve the stabilization property or on the contrary can destroy it. This happens especially on border regions, where the ideal controller enters instability.
- The simulations also show, when increasing the gain K of the controller, it does not necessarily imply that the quantizations errors increase as it is for linear controllers.

For such complex systems it is clear that the means of simulations tools are of great importance in establishing the proper values for the design parameters of the control laws. Other analysis that was not done in this paper is the analysis of quantization when the controllers are implemented in fixed-point representation, as is the case of FPGA controllers. In this case more degradation of the controller performance is expected but in the same lines as pointed here. The ending remark is that the proposed digital design is “robust” in the presence of quantizations errors that occur in the measurements of the state variables or when considering coefficients quantizations.

CONCLUSIONS AND FUTURE WORK

CONCLUSIONS AND FUTURE WORK

12.1 CONCLUSIONS

The thesis brings important contributions in the field of sampled-data nonlinear systems. One of the main objective of this work is to migrate the 'ideal' controller solutions - designed in continuous-time and with rigorous theory in the back - to practical implementations. The theoretical advancements, that have been done in this thesis, have contributed to a series of practical implementations of these strategies. The results obtained in these applications, showed that a suitable sampled-data design can recover the performance of the ideal control structures proposed in the continuous-time domain, and which were degraded through sampling. A vital role in designing such controllers is to understand what is happening in the continuous-time behavior of the system, and how the nonlinear control strategy employed can be suitably adapted in a sampled-data context. In this work, nonlinear strategies such as backstepping, Lyapunov design, IDA-PBC, Singular Perturbation have been discussed and adapted for sampled-data systems. In the same time, a concern was to develop symbolic algorithms in order to assist in the automatic computation of such controllers and to make easier the real-time implementation.

More specific conclusions are split in three parts, in the same way as the structure of the thesis. Each part corresponds to a complementary direction on which this thesis brings important advancements.

12.1.1 *Theoretical developments*

The thesis has mainly discussed the performance of the input/output and input/Lyapunov matching strategies in the context of backstepping stabilization method and passivity based control. The thesis has paid close attention to the systems in strict-feedback form and consequently to the method of backstepping design. In this direction two novel control strategies were designed and developed in two versions: a single rate and a multi-rate approach. It has been shown that the methodologies are superior, in terms of stabilizing properties, to the usual emulation of the continuous-time backstep-

ping controllers. The multi-rate version, is proved to impose better stability performance compared with the single-rate design. The multi-rate approach allowed us to extend the number of controlled objectives to be imposed. The performance of such digital controllers have been compared with similar procedures that were found in the literature. The multi-rate version has been proved to be the best method in terms of stability performances, when increasing the gains of the controller and/or the sampling period.

12.1.2 *The SimNLSys Toolbox*

Another important direction is represented by the **CADC** software application. This work is still in progress and it relies especially on the symbolic tools provided by the Matlab environment. There have been explained the benefits of using symbolic tools and also their limits when referring to the **SimNLSys** application. Another aspect mentioned here is that the software designer for the control systems encompasses symbolic and numerical algorithms, graphical and text/code manipulations. The time of the computation of such solutions is not critical since it is an “off-line” task. However the increased complexity of the controller expressions give some problems related to the computations memory which is available.

This application is developed as a self contained software package which is intended to be provided to all those members of the control community interested in digital control of nonlinear systems.

12.1.3 *Applications*

An important direction of the thesis is represented by the examples (academic or experimental) that were employed to illustrate the performances of the proposed strategies. Let us consider each case.

The single-rate backstepping version is evaluated on the experimental plant of an electro-magnetic suspension (available at Control Department of Supelec, Gif-sur-Yvette campus) in [Chapter 7](#). The simulation results were confirmed by the experimental tests. This case study represents a real example where the digital design actually provides higher performance compared with the emulated versions. An important fact that was also revealed is the controller stabilizing time value, that appears to be improved by using the proposed sampled-data controller.

The second case study, uses the same criteria of input/Lyapunov matching in the design of a digital version of an L_gV controller, in [Chapter 8](#). The context of this study is characterized by the passivity properties and how these can be preserved under sampling. The experimental plant is available at the University Politehnica Bucharest.

The case study presented in [Chapter 9](#) concerns two distinct problems. One is about a direct digital design, when a finite discrete-time representation of the system exists. And the other one, concerns

the problems involving communications delays. In this study a stabilizing controller was proposed, and also a state predictor was developed in order to handle with the delays.

The fourth case study (Chapter 10) concerns the electric management of a fuel cell and supercapacitors system with direct applications in the automotive industry. The sampled-data designs proposed, starting from two different nonlinear continuous-time strategies, bring specific improvements. This study is performed in the frame of the project PEPS "Automatique" - GESE - Gestion Echantillonnée des Systèmes Energétiques, project supported by the CNRS-INSIS institute.

The last case study is dedicated to the study of quantization effects in sampled-data systems. Complex simulations were performed, for both the digital designs proposed in Chapter 4, to evaluate how the stabilization is preserved. The stability is affected by quantizations with a reduced error level which is depending on the size of the quantization error.

All the control expression computations, provided in these case studies, were possible by means of the **SimNLSys** application.

GENERAL CONCLUSION An important conclusion related to the sampled-data controller design here proposed is the following: *The approximated digital controller, designed under the criteria of input/Lyapunov matching, offers theoretically an asymptotic stabilization of the nonlinear dynamics of the concerned system, and a practical stabilization when it is implemented on real systems. This design allows to increase (under some conditions) the gains of the controllers and also the amplitude of the sampling period, over the limits obtained for an emulated controller. When increasing the order of the approximated controller better performance can be expected, but the drawback is that the complexity of the controller expressions increases exponentially making real implementation more difficult.*

In spite of the fact that a smaller value for δ gives satisfactory results for the emulated control, there are situations when this value could not be acceptable for the hardware equipment (as in the case of the magnetic suspension). In our case, although the sampling periods are small, these are sufficiently large to allow all the controls computation and the communications with the plant.

12.2 FUTURE WORK

The future work concerns the implementation and evaluation of new digital strategies on certain experimental plants.

The multi-rate version of the backstepping controller, is planned to be tested soon. As the simulation results showed high performance, one has the same expectations for the practical evaluations.

However, as backstepping strongly relies on passivity properties and passivation under state feedback, a direct digital scheme that exploits these properties could also be considered. The work is progressing in this direction.

Three main directions for the future work can be launched.

12.2.1 *Theoretical developments*

The main idea is to continue the development of new digital designs issued from nonlinear continuous-time strategies, in order to migrate the theoretical available results to a more practical use. In the same time, rigorous analysis of the effects of the sampling length and of the design parameters is mandatory in order to provide a clear performance characterization of a sampled-data controller.

FURTHER SAMPLED-DATA DESIGNS FOR STRICT-FEEDBACK SYSTEMS Based on the digital designs proposed for the strict-feedback systems there are some ideas that can offer new digital solutions. Some ideas involve:

- developpements of specific criteria to allow a better qualitative performance analysis of the sampled-data controllers in conjunction with the sampling period, convergence speed, quantization errors or perturbations.
- a new sampled-data design based on semiglobal continuous-time designs such as: semiglobal backstepping or high gain control. These solutions are not so restrictive as the backstepping solution and can be used when one considers the case of multiple cascade connections. These procedures can lead to simpler expressions of the continuous-time controller and hence of the digital controller's terms.
- other sampled-data solution which can be based on modified Lyapunov function under digital feedback instead of reproducing the continuous time Lyapunov evolution.

PASSIVITY AND OPTIMALITY As direct and inverse optimal control strategies also rely on passivity properties, some extensions can also be done in this context. A first attempt is discussed in papers [Monaco & Normand-Cyrot 2012] and [Tanasa *et al.* 2012]. The sampled-data solution discussed aims to preserve the optimal stabilizing properties with the same V and with a modified cost. An idea that has to be investigated is how to modify the Lyapunov function V under sampling in order to obtain better stabilizing reproduction of the continuous-time case.

SINGLE PERTURBATION THEORY The author also considers that interesting solutions can be proposed for problems involving singularly perturbed systems. This type of systems is characterized by multiple time-scales, and a multi-rate controller strategy seems to be the most suitable way for this context. The solutions already obtained for the dynamics of a strict-feedback systems should be adapted to the new context. A first practical application is the digital energy management of a fuel cell system [Hilairet *et al.* 2012].

DELAY AND OBSERVER DESIGN Another problem that is important for practical implementations is the need of observer schemes. As the controller solutions are based on the state measurements, suitable observers should be designed. Further work should investigate how different observer designs can ameliorate or not the stabilizing properties of the digital solutions considered. A first attempt has been done for systems with delays, where states predictor have been computed when considering the particular case of a feed-forward system [Monaco *et al.* 2012].

12.2.2 Software development

In the same time with the theoretical advancements, new modules of the **SimNLSys** CAD software can be implemented. For example, making reference to the passivity concepts introduced in [Monaco *et al.* 2011] certain strategies proposed in [Tiefensee *et al.* 2010a] can be added to the toolbox.

Another concern should be the improvement of the symbolic algorithms by using new available techniques regarding the expressions simplifiers (for example for radical terms). Also an efficient compromise mechanism between the speed of computation and expression simplification should be proposed. To reduce the time of computation, a new solution may consist in parallelizing the existing algorithms.

Related to simulation tools, specific modules have to be considered to for evaluating 'off-line' the performance if the sampled-data controller computed.

Another objective is to adapt the software to a wider use. In this case, improving the conviviality of the interface is required. Another concern from the point of view of the costs should be the migration to a free software development tool such as Scilab.

12.2.3 *Applications*

The new digital designs that are expected to be proposed, and also the multi-rate backstepping version (already proposed in this work) are expected to be also evaluated on practical setups. For example the multi-rate backstepping strategy can easily be tested on systems such as the magnetic pendulum or coupled-tanks, already studied in this thesis.

The energetic management of the fuel cell system is open for many opportunities. A new digital design that can be implemented makes reference to the multiple scale-time problem. It is expected that a multi-rate solution should be employed either on the reduced model (3 state model), or on the complete model (5 state model). Maybe the solution proposed here will also solve the problem of the singular perturbation theory under a sampled-data context. Other problems that can be taken into account are the compensation of the electrical losses of the converters and the presence of the noise in the measures.

There is an important number of actual control problems that can be addressed in a sampled-data context. Actual popular topics are addressing problems dealing with communication delays, energetic management, optimal and passivity based control and others. The topics proposed in this thesis represent a good start to handle such problems.

Part IV

APPENDIX

13

MIMO COMPUTATIONS USED IN CHAPTER 3

The first Lie derivatives terms, that appear in the computation of a second order approximated controller, are computed as follows,

$$L_f \bar{V} = \begin{bmatrix} L_f V_1 \\ \vdots \\ L_f V_p \end{bmatrix} \in \mathbb{R}^{p \times 1} \quad L_{\bar{g}} \bar{V} = \begin{bmatrix} L_{g_1} V_1 & L_{g_2} V_1 & \cdots & L_{g_m} V_1 \\ L_{g_1} V_2 & L_{g_2} V_2 & \cdots & L_{g_m} V_2 \\ \vdots & \vdots & \ddots & \vdots \\ L_{g_1} V_p & L_{g_2} V_p & \cdots & L_{g_m} V_p \end{bmatrix} \in \mathbb{R}^{p \times m}$$

$$L_f^2 \bar{V} = \begin{bmatrix} L_f^2 V_1 \\ \vdots \\ L_f^2 V_p \end{bmatrix} \in \mathbb{R}^{p \times 1}$$

$$L_{\bar{g}} L_f \bar{V} = \begin{bmatrix} L_{g_1} L_f V_1 & L_{g_2} L_f V_1 & \cdots & L_{g_m} L_f V_1 \\ L_{g_1} L_f V_2 & L_{g_2} L_f V_2 & \cdots & L_{g_m} L_f V_2 \\ \vdots & \vdots & \ddots & \vdots \\ L_{g_1} L_f V_p & L_{g_2} L_f V_p & \cdots & L_{g_m} L_f V_p \end{bmatrix} \in \mathbb{R}^{p \times m}$$

$$L_f L_{\bar{g}} \bar{V} = \begin{bmatrix} L_f L_{g_1} V_1 & L_f L_{g_2} V_1 & \cdots & L_f L_{g_m} V_1 \\ L_f L_{g_1} V_2 & L_f L_{g_2} V_2 & \cdots & L_f L_{g_m} V_2 \\ \vdots & \vdots & \ddots & \vdots \\ L_f L_{g_1} V_p & L_f L_{g_2} V_p & \cdots & L_f L_{g_m} V_p \end{bmatrix} \in \mathbb{R}^{p \times m}$$

$$L_{g_1}^2 \bar{V} = \begin{bmatrix} \left[\begin{array}{ccc} L_{g_1}^2 V_1 & \cdots & L_{g_1} L_{g_m} V_1 \\ L_{g_1}^2 V_2 & \cdots & L_{g_1} L_{g_m} V_2 \\ \vdots & \ddots & \vdots \\ L_{g_1}^2 V_p & \cdots & L_{g_1} L_{g_m} V_p \end{array} \right] & \cdots & \left[\begin{array}{ccc} L_{g_m} L_{g_1} V_1 & \cdots & L_{g_m}^2 V_1 \\ L_{g_m} L_{g_1} V_2 & \cdots & L_{g_m}^2 V_2 \\ \vdots & \ddots & \vdots \\ L_{g_m} L_{g_1} V_p & \cdots & L_{g_m}^2 V_p \end{array} \right] \end{bmatrix} \in \mathbb{R}^{p \times m^2}$$

$$\text{or } L_{g_1}^2 \bar{V} = \begin{bmatrix} L_{g_1} L_{g_i} V_1 & \cdots & L_{g_m} L_{g_i} V_1 \\ L_{g_1} L_{g_i} V_2 & \cdots & L_{g_m} L_{g_i} V_2 \\ \vdots & \ddots & \vdots \\ L_{g_1} L_{g_i} V_p & \cdots & L_{g_m} L_{g_i} V_p \end{bmatrix} \in \mathbb{R}^{l \times m^2}$$

where $L_{g_j} L_{g_i} V_k = [L_{g_j} L_{g_1} V_k \cdots L_{g_j} L_{g_m} V_k]$ is a structure with m vectors, for $\forall j \in [1, m]$ and $\forall k \in [1, l]$

Now it is necessary to introduce the ' \odot ' product that will be useful in the computation of the sampled-data control.

Definition 53. Given $M \in \mathbb{R}^{(l, m^2)}$ with following representation,

$$M = \begin{bmatrix} M_{11}^i & \cdots & M_{1m}^i \\ M_{21}^i & \cdots & M_{2m}^i \\ \vdots & \ddots & \vdots \\ M_{p1}^i & \cdots & M_{pm}^i \end{bmatrix} \in \mathbb{R}^{l \times m^2} \tag{13.1}$$

where $M_{jk}^i = [M_{jk1} M_{jk2} \cdots M_{jkm}]$ for $\forall j \in [1, m]$ and $\forall k \in [1, l]$ and vector $v \in \mathbb{R}^m$, then the product $M \odot v$ is equal with:

$$M \odot v = \begin{bmatrix} M_{11}^i v & \cdots & M_{1m}^i v \\ M_{21}^i v & \cdots & M_{2m}^i v \\ \vdots & \ddots & \vdots \\ M_{p1}^i v & \cdots & M_{pm}^i v \end{bmatrix} \in \mathbb{R}^{l \times m} \tag{13.2}$$

SINGLE AND MULTI-RATE CONTROLLER TERMS COMPUTATIONS

14.1 SINGLE-RATE CONTROLLER DESIGN

The controller is designed such that next equality holds for every δ

$$V(x_{k+1}) - V(x_k) = \int_{k\delta}^{(k+1)\delta} \dot{V}(x_c(\tau)) d\tau. \quad (14.1)$$

where

$$x_{k+1} = F^\delta(x_k, u_k) = e^{(f_c + u_k g_c)} Id \quad (14.2)$$

with Id as the identity function. Starting from this expansion one can compute the next Lyapunov difference as follows

$$V(x_{k+1}) - V(x_k) = \delta(L_{f_c} + u_k L_{g_c})V(x) + \frac{\delta^2}{2!} \delta(L_{f_c} + u_k L_{g_c})^2 V(x) + O(\delta^3)|_{t=k\delta} \quad (14.3)$$

The same expansion is performed for the continuous-time evolution of V , one gets

$$\begin{aligned} V(x_c(k + 1\delta)) &= \left(1 + \delta(L_{f_c} + u_c L_{g_c}) + \frac{\delta^2}{2!} \left((L_{f_c} + u_c L_{g_c})^2 + \dot{u}_c L_{g_c}\right)\right. \\ &+ \frac{\delta^3}{3!} \left((L_{f_c} + u_c L_{g_c})^3 + 2\dot{u}_c(L_{f_c} + u_c L_{g_c})L_{g_c} + \ddot{u}_c L_{g_c}(L_{f_c} + u_c L_{g_c}) + \ddot{u}_c L_{g_c}\right) \\ &+ \dots \left.) V|_{x_c(k\delta)} \right) \end{aligned} \quad (14.4)$$

By imposing the controller expression as

$$u_k = u_{d0} + \frac{\delta}{2} u_{d1} + \frac{\delta^2}{2!} u_{d2} + \dots \quad (14.5)$$

To compute the terms of the controller (14.5), then by replacing u_k in (14.3) with (14.5), and by imposing the equality $V(x_c((k+1)\delta)) = V(x_{k+1})$ one gets:

$$u_{d0}(x_k) = u_c|_{x_k} \quad (14.6)$$

$$u_{d1}(x_k) = \dot{u}_c|_{x_k} \quad (14.7)$$

$$u_{d2}(x_k) = \ddot{u}_c + \frac{u_{d1}}{2} \text{ad}_{[f_c, g_c]} V(L_g V)^{-1}|_{x_k}. \quad (14.8)$$

$$\begin{aligned} u_{d3}(x_k) &= \ddot{u}_c + \frac{\ddot{u}_c}{L_g V} \text{ad}_{[f, g]} V|_{x_k} \\ &+ \frac{\dot{u}_c}{L_g V} (-\text{ad}_f^2 g + u_c \text{ad}_f g L_g + 2L_f^2 L_g - 3L_f L_g L_f) V|_{x_k} \\ &- \frac{\dot{u}_c}{L_g V} ((L_f L_g + L_g L_f + 2u_c L_g^2) V \text{ad}_f g) V|_{x_k}. \end{aligned} \quad (14.9)$$

14.2 MULTI-RATE OF CONTROLLER TERMS COMPUTATIONS

Next there are provided the computations for the 2-rate controller. Let us start with the first matching condition imposed on V , previously given in (14.1), with the difference that

$$x_{k+1} = F^\delta(x_k, u_{1k}, u_{2k}) = e^{\text{BCH}^2\left(\frac{\delta}{2}(f_c + u_{1k}g_c), \frac{\delta}{2}(f_c + u_{2k}g_c)\right)} \quad (14.10)$$

where BCH^2 is the 2nd order Baker-Campbell Hausdorff exponent. Let us compute first the Lyapunov V at instant $(k+1)\delta$ starting from the expansion (14.10).

$$V(x_{k+1}) = e^{\frac{\delta}{2}(f_c + u_{1k}g_c)} \circ e^{\frac{\delta}{2}(f_c + u_{2k}g_c)} V|_{x_k} \quad (14.11)$$

$$\begin{aligned} V(x_{k+1}) &= \left(1 + \frac{\delta}{2}(L_{f_c} + u_{1k}L_{g_c}) + \frac{\delta^2}{8}(L_{f_c} + u_{1k}L_{g_c})^2 + \dots\right) \\ &\quad \circ \left(1 + \frac{\delta}{2}(L_{f_c} + u_{2k}L_{g_c}) + \frac{\delta^2}{8}(L_{f_c} + u_{2k}L_{g_c})^2 + \dots\right) V|_{x_k} \\ V(x_{k+1}) &= \left(1 + \frac{\delta}{2}(2L_{f_c} + (u_{1k} + u_{2k})L_{g_c}) + \frac{\delta^2}{4 \cdot 2!}(4L_{f_c}^2 + (2u_{1k}u_{2k} + u_{1k}^2 + u_{2k}^2)L_{g_c}^2 \right. \\ &\quad \left. + (u_{1k} + 3u_{2k})L_{f_c}L_{g_c} + (u_{2k} + 3u_{1k})L_{g_c}L_{f_c}\right) V|_{x_k} + \frac{\delta^3}{2^3 \cdot 3!} \left((L_{f_c} + u_{1k}L_{g_c})^3 \right. \\ &\quad \left. + (L_{f_c} + u_{2k}L_{g_c})^3 + 3\left((L_{f_c} + u_{1k}L_{g_c})(L_{f_c} + u_{2k}L_{g_c})^2 \right. \right. \\ &\quad \left. \left. + (L_{f_c} + u_{1k}L_{g_c})^2(L_{f_c} + u_{2k}L_{g_c}) \right) \right) V|_{x_k} + \dots \end{aligned}$$

Now the series expansions of u_{1k} and u_{2k} , are given by:

$$u_{1k} = u_{d10} + \frac{\delta}{2 \cdot 2!} u_{d11} + \frac{\delta^2}{4 \cdot 3!} u_{d12} \quad (14.12)$$

$$u_{2k} = u_{d20} + \frac{\delta}{2 \cdot 2!} u_{d21} + \frac{\delta^2}{4 \cdot 3!} u_{d22} \quad (14.13)$$

By replacing in (14.11), then:

$$\begin{aligned} V(x_{k+1}) &= \left(1 + \frac{\delta}{2}(2L_{f_c} + (u_{d10} + u_{d20})L_{g_c}) \right. \\ &\quad \left. + \frac{\delta^2}{4 \cdot 2!}(4L_{f_c}^2 + (2u_{d10}u_{d20} + u_{d10}^2 + u_{d20}^2)L_{g_c}^2 + (u_{d10} + 3u_{d20})L_{f_c}L_{g_c} \right. \\ &\quad \left. + (u_{d20} + 3u_{d10})L_{g_c}L_{f_c} + (u_{d11} + u_{d21})L_{g_c}\right) + \frac{\delta^3}{2^3 \cdot 3!} \left[(L_{f_c} + u_{d10}L_{g_c})^3 \right. \\ &\quad \left. + (L_{f_c} + u_{d20}L_{g_c})^3 + 3\left((L_{f_c} + u_{d10}L_{g_c})(L_{f_c} + u_{d20}L_{g_c})^2 \right. \right. \\ &\quad \left. \left. + (L_{f_c} + u_{d10}L_{g_c})^2(L_{f_c} + u_{d20}L_{g_c}) \right) \right] + \frac{3}{2} \left((u_{d11} + 3u_{d21})L_{f_c}L_{g_c} + (u_{d21} \right. \\ &\quad \left. + 3u_{d11})L_{g_c}L_{f_c} + 3(u_{d10}u_{d21} + u_{d11}u_{d20})L_{g_c}^2 + (u_{d21} + u_{d22})L_{g_c} \right] + \dots \Big) V|_{x_k} \quad (14.14) \end{aligned}$$

Now the expansion for the continuous-time evolution $V(x_c((k+1)\delta))$ is given in (14.4). The condition for finding the controller components is now: $V(x_{k+1}) = V(x_c((k+1)\delta))$, for all δ . Then it results,

$$\begin{aligned}
 u_{d10} + u_{d20} &= 2u_c \\
 u_{d11} + u_{d21} &= 4\dot{u}_c \\
 u_{d12} + u_{d22} &= 8\ddot{u}_c + \left[\dot{u}_c(10L_{f_c}L_{g_c} + 2L_{g_c}L_{f_c} + 12u_cL_{g_c}^2) - 3u_{d21}L_{f_c}L_{g_c} \right. \\
 &\quad \left. - 3u_{d11}L_{g_c}L_{f_c} \right] V/L_{g_c}V
 \end{aligned} \tag{14.15}$$

The same computations need to be done for the second objective:

$$W(x_{k+1}) - W(x_k) = \int_{k\delta}^{(k+1)\delta} \dot{W}(x_c(\tau)) d\tau. \tag{14.16}$$

By looking to equations (14.14),(14.4) and taking into account that $L_{g_c}^i W = 0$, for $i \geq 1$ and $L_{g_c}L_{f_c}W \neq 0$, then:

$$\begin{aligned}
 W(x_{k+1}) &= \left(1 + \frac{\delta}{2}[2L_{f_c}] + \frac{\delta^2}{4 \cdot 2!} [4L_{f_c}^2 + (u_{d20} + 3u_{d10})L_{g_c}L_{f_c}] + \frac{\delta^3}{2^3 \cdot 3!} \left[\underbrace{\dots}_{\equiv (L_{f_c} + u_c L_{g_c})^3} \right. \right. \\
 &\quad \left. \left. + \frac{3}{2} ((u_{d21} + 3u_{d11})L_{g_c}L_{f_c}) \right] + \frac{\delta^4}{2^4 \cdot 4!} \left[\underbrace{\dots}_{\equiv (L_{f_c} + u_c L_{g_c})^4} + 2(u_{d11}(3L_{g_c}L_{f_c}^2 + 2L_{f_c}L_{g_c}L_{f_c}) \right. \right. \\
 &\quad \left. \left. + u_{d21}(L_{g_c}L_{f_c}^2 + 2L_{f_c}L_{g_c}L_{f_c}) + (u_{d10}u_{d21} + u_{d11}u_{d20})L_{g_c}^2L_{f_c} \right. \right. \\
 &\quad \left. \left. + (u_{d22} + 3u_{d12})L_{g_c}L_{f_c} \right] \dots \right) W|_{x_k}
 \end{aligned} \tag{14.17}$$

Now the expansion for $W(x_c((k+1)\delta))$ for the continuous-time case is given by,

$$\begin{aligned}
 W(x_c((k+1)\delta)) &= \left(1 + \delta L_{f_c} + \frac{\delta^2}{2!} (L_{f_c}^2 + u_c L_{g_c}L_{f_c}) + \frac{\delta^3}{3!} ((L_{f_c} + u_c L_{g_c})^3 + \dot{u}_c L_{g_c}L_{f_c}) \right. \\
 &\quad \left. + \frac{\delta^4}{4!} [(L_{f_c} + u_c L_{g_c})^4 + \dot{u}_c(L_{f_c}L_{g_c}L_{f_c} + L_{g_c}L_{f_c}^2 + 2u_cL_{g_c}^2L_{f_c}) + \ddot{u}_c L_{g_c}L_{f_c}] \dots \right) W|_{t=k\delta}
 \end{aligned} \tag{14.18}$$

Now, by imposing again the condition : $W(x_{k+1}) = W(x_c((k+1)\delta))$, for all δ . Then it results,

$$\begin{aligned}
 u_{d20} + 3u_{d10} &= 4u_c \\
 u_{d21} + 3u_{d11} &= \frac{16}{3}\dot{u}_c \\
 u_{d22} + 3u_{d12} &= 8\ddot{u}_c + \left[8\dot{u}_c(L_{f_c}L_{g_c}L_{f_c} + L_{g_c}L_{f_c}^2 + 2u_cL_{g_c}^2L_{f_c}) - u_{d11}(2L_{f_c}L_{g_c}L_{f_c} + 3L_{g_c}L_{f_c}^2) \right. \\
 &\quad \left. - u_{d21}(2L_{f_c}L_{g_c}L_{f_c} + L_{g_c}^2L_{f_c}) - (u_{d11} + u_{d21})u_cL_{g_c}^2L_{f_c} \right] W/L_{g_c}L_{f_c}W
 \end{aligned} \tag{14.19}$$

The unique solution can be found by solving the linear system (14.15)-(14.19).

15

ELECTRICAL AND PHYSICAL PARAMETERS OF THE FC/SCS SYSTEM

Table 15.1: Electric characteristics of the hybrid system.

Fuel cell parameters	Value
Open circuit voltage E	45 V
Rated voltage	26 V
Rated current	46 A
Supercapacitors parameters	
Capacitance	26 F
Rated voltage	30 V
Rated current	200 A
Optimal voltage (v_{sc}^*)	21 V
Electric load parameters	
Rated power	1800 W
Rated voltage	60 V
Rated current	150 A
Inductance and capacitive parameters	
L_{fc} inductance	200 μ H
L_{sc} inductance	100 μ H
Rated current L_{fc}	100 A
Rated current L_{sc}	150 A
Capacities C	9 mF
Optimal DC bus voltage (v_b^*)	50 V

BIBLIOGRAPHY

- [Ahmad *et al.* 1992] S. Ahmad, L.H. Keel and S.P. Bhattacharyya. *Computer aided robust control design for interval control systems*. In *Computer-Aided Control System Design, 1992. (CACSD), 1992 IEEE Symposium on*, pages 82 –89, mar 1992.
- [Akhrif & Blankenship 1988] O. Akhrif and G.L. Blankenship. *Design of nonlinear control systems using CONDENS*. In *Proc. of IEEE National Aerospace and Electronics Conf.*, volume 2, pages 372 – 379, 1988.
- [Almutairi & Zribi 2006] N.B. Almutairi and M. Zribi. *Sliding mode control of coupled tanks*. *Mechatronics*, vol. 16, no. 7, pages 427 – 441, 2006.
- [Antsaklis & Baillieul 2004] P. Antsaklis and J. Baillieul. *Guest Editorial Special Issue on Networked Control Systems*. *Automatic Control, IEEE Transactions on*, vol. 49, no. 9, pages 1421 – 1423, sept. 2004.
- [Artstein 1983] Z. Artstein. *Stabilization with relaxed controls*. *Nonlinear Analysis*, vol. 7, pages 1163–1173, 1983.
- [Astrom & Wittenmark 2011] K.A. Astrom and B. Wittenmark. *Computer-controlled systems: Theory and design*, third edition. *Dover Books on Electrical Engineering Series*. Dover Publications, 2011.
- [Aström *et al.* 1984] K.J. Aström, P. Hagander and J. Sternby. *Zeros of sampled systems*. *Automatica*, vol. 20, no. 1, pages 31 – 38, 1984.
- [Azib *et al.* 2011] T. Azib, M. Hilairet, O. Bethoux and Talj R. *Experimental validation of a passivity-based controller for coordination of converters in a fuel cell System*. In *Fundamentals and Developments of Fuel Cells; Fundamentals and Developments of Fuel Cells - FDFC*, 2011.
- [Bao & Lee 2007] J. Bao and P.L. Lee. *Process control. the passive systems approach*. Springer, 2007.
- [Barbot *et al.* 1996] J.P. Barbot, M. Djemai, S. Monaco and D. Normand-Cyrot. *Analysis and control of nonlinear singularly perturbed systems under sampling*. In Cornelius T. Leondes, editeur, *Digital Control Systems Implementation and Computational Techniques*, volume 79 of *Control and Dynamic Systems*, pages 203 – 246. Academic Press, 1996.

- [Bazanella *et al.* 1999] A.S. Bazanella, P.V. Kokotovic and A.S. e Silva. *A dynamic extension for LgV controllers*. Automatic Control, IEEE Transactions on, vol. 44, no. 3, pages 588–592, mar 1999.
- [Becherif *et al.* 2006] M. Becherif, M.Y. Ayad and A. Miraoui. *Modeling and Passivity-Based Control of Hybrid Sources: Fuel Cell and Supercapacitors*. In Industry Applications Conference, 2006. 41st IAS Annual Meeting. Conference Record of the 2006 IEEE, volume 3, pages 1134–1139, oct. 2006.
- [Bemporad *et al.* 2010] A. Bemporad, M. Heemels and M. Johansson. *Networked control systems*. Lecture Notes in Control and Information Sciences. Springer, 2010.
- [Bertram 1958] J. E. Bertram. *The effect of quantization in sampled-feedback systems*. Trans. Amer. Inst. Elec. Engrs., vol. 2, pages 177–182, 1958.
- [Besançon & Bornard 1997] G. Besançon and G. Bornard. *Symbolic computation in nonlinear control systems analysis: The example of bilinearization*. Mathematics and Computers in Simulation, vol. 44, pages 11–27, 1997.
- [Bhuvaneswari *et al.* 2009] N.S. Bhuvaneswari, G. Uma and T.R. Rangaswamy. *Adaptive and optimal control of a non-linear process using intelligent controllers*. Applied Soft Computing, vol. 9, no. 1, pages 182–190, 2009.
- [Boucher & Dumur 2006] P. Boucher and D. Dumur. *La commande prédictive: avancées et perspectives*. IC2: Série Systèmes automatisés. Hermes Science Publications, 2006.
- [Burlion *et al.* 2006] L. Burlion, T. Ahmed-Ali and F. Lamnabhi-Lagarrigue. *On the stabilization of sampled-data non-linear systems by using backstepping on the higher order approximate models*. International Journal of Control, vol. 79, pages 1087–1095, 2006.
- [Cacciato *et al.* 2004] M. Cacciato, F. Caricchi, F. Giulii and E. Santini. *A critical evaluation and design of bi-directional DC/DC converters for supercapacitors interfacing in fuel cell applications*. In Proc. IEEE IAS'04, volume 2, pages 1127–1133, 2004.
- [Celentano 2012] L. Celentano. *New results on practical stability for linear and nonlinear uncertain systems*. Nuova Cultura, 2012.
- [Chelouah *et al.* 1993] A. Chelouah, P. Di Giamberardino, S. Monaco and D. Normand-Cyrot. *Digital control of nonholonomic systems two case studies*. In Decision and Control, 1993., Proceedings of the 32nd IEEE Conference on, pages 2664–2669 vol.3, dec 1993.

- [Chen & Francis 1995] T. Chen and B. A. Francis. *Optimal sampled-data control systems*. Springer-Verlag, London, 1995.
- [Chen 2004] Guanrong Chen. *Encyclopedia of rf and microwave engineering, chapitre Stability of Nonlinear Systems*, pages 4881–4896. Wiley, New York, 2004.
- [Clarke *et al.* 1997] F.H. Clarke, Y.S. Ledyaev, E.D. Sontag and A.I. Subbotin. *Asymptotic controllability implies feedback stabilization*. *Automatic Control, IEEE Transactions on*, vol. 42, no. 10, pages 1394–1407, oct 1997.
- [Comeau & Hori 1998] A.R. Comeau and N. Hori. *State-space forms for higher-order discrete-time models*. *Systems & Control Letters*, vol. 34, no. 1-2, pages 23–31, 1998.
- [de Jager 1995] Bram de Jager. *The Use of Symbolic Computation in Nonlinear Control: Is It Viable ?* *IEEE Transactions on Automatic Control*, vol. 40, pages 84–89, 1995.
- [De Persis 2005] C. De Persis. *On feedback stabilization of nonlinear systems under quantization*. In *Decision and Control, 2005 and 2005 European Control Conference. CDC-ECC '05. 44th IEEE Conference on*, pages 7698–7703, dec. 2005.
- [Di Giamberardino *et al.* 1996a] P. Di Giamberardino, F. Grassini, S. Monaco and D. Normand-Cyrot. *Piecewise continuous control for a car-like robot: implementation and experimental results*. In *Decision and Control, 1996., Proceedings of the 35th IEEE, volume 3*, pages 3564–3569 vol.3, dec 1996.
- [Di Giamberardino *et al.* 1996b] P. Di Giamberardino, F. Grassini, S. Monaco and D. Normand-Cyrot. *Piecewise continuous control for a car-like robot: implementation and experimental results*. In *Decision and Control, 1996., Proceedings of the 35th IEEE, volume 3*, pages 3564–3569 vol.3, dec 1996.
- [Di Giamberardino *et al.* 2002] P. Di Giamberardino, S. Monaco and D. Normand-Cyrot. *Why multirate sampling is instrumental for control design purpose: the example of the one-leg hopping robot*. In *Decision and Control, 2002, Proceedings of the 41st IEEE Conference on*, volume 3, pages 3249–3254 vol.3, dec. 2002.
- [Djemai *et al.* 1999] M. Djemai, J.-P. Barbot and H. Khalil. *Digital Multi-rate control for a class of nonlinear singularly perturbed systems*. *Int. Journal of Control*, vol. 72, no. 10, pages 851–865, 1999.
- [Dormand & P.J.Prince 1980] J.R. Dormand and P.J.Prince. *A family of embedded Runge-Kutta formulae*. *Journal of Computational and Applied Mathematics*, vol. 6(1), pages 19–26, 1980.
- [Eborn *et al.* 1999] J. Eborn, H. Panagopoulos and K.J. Aström. *Robust PID Control of Steam Generator Water Level*. *Preprints 14th IFAC World Congress July 59 1999 Beijing China*, no. G-2e-18-2, pages 461–464, 1999.

- [Eldeib & Tsai 1988] Hany K. Eldeib and Sean Tsai. *Applications of symbolic manipulation in control system analysis and design*. In Proc. IEEE Intern. Symposium on Intelligent Control, pages 269–274, 1988.
- [France 1921] A. France. *Le jardin d'épicure*. Collection nouvelle. Calmann-Lévy, 1921.
- [Franklin *et al.* 1998] G.F. Franklin, J.D. Powell and M.L. Workman. *Digital control of dynamic systems*. Addison-Wesley world student series. Addison-Wesley, 1998.
- [Fromion *et al.* 1996] V. Fromion, S. Monaco and D. Normand-Cyrot. *A link between input-output stability and Lyapunov stability*. Syst. and Contr. Lett., vol. 27, pages 243–248, 1996.
- [Fujioka *et al.* 1999] H. Fujioka, Y. Yamamoto and S. Hara. *Sampled-Data Control Toolbox: A Software Package via Object-Oriented Programming*. In Proc. of the 1999 IEEE ISACSD, 1999. Kohala Coast-Island of Hawaii.
- [Gasparyan 2006] O.N. Gasparyan. *Computer-aided analysis and design of linear and nonlinear multivariable control systems: A classical approach*. In Computer Aided Control System Design, 2006 IEEE International Conference on Control Applications, 2006 IEEE International Symposium on Intelligent Control, 2006 IEEE, pages 1958–1963, oct. 2006.
- [Gennaro 2002] S. Di Gennaro. *Output attitude tracking for flexible spacecraft*. Automatica, vol. 38, no. 10, pages 1719 – 1726, 2002.
- [Ghanes *et al.* 2011] M. Ghanes, M. Hilairet, J.-P. Barbot and O. Bethoux. *Singular perturbation control for coordination of converters in a fuel cell system*. In Proc. Electrimacs, 2011.
- [Ghanes *et al.* 2012] M. Ghanes, O. Bethoux, M. Hilairet and J.-P. Barbot. *Validation Expérimentale D'une Commande Aux Perturbations Singulières D'un Système Pile à Combustible/super Capacités*. In Proc. CIFA, 2012.
- [Goodwin *et al.* 2010] G.C. Goodwin, J.I. Yuz, J.C. Agüero and M. Cea. *Sampling and sampled-data models*. In Proc. ACC, Baltimore, 2010.
- [Grobner & Knapp 1967] W. Grobner and H. Knapp. *Contributions to the method of lie series*. Bibliographisches Institut, 1967.
- [Halanay & Rasvan 2000] A. Halanay and V. Rasvan. *Stability and stable oscillations in discrete time systems*. Advances in discrete mathematics and applications. Taylor & Francis, 2000.
- [Halanay & Răsvan 1977] A. Halanay and Vl. Răsvan. *General theory of linear hybrid control*. Int. Journal of Control, vol. 26, no. 4, pages 621–634, 1977.

- [Hanselmann 1987] H Hanselmann. *Implementation of digital controllers -a survey*. Automatica, vol. 23, no. 1, pages 7–32, jan 1987.
- [Hilairet et al. 2010] M. Hilairet, O. Bethoux, T. Azib and R. Talj. *Commande non-linéaire d'un système pile à combustible / supercondensateur*. In Proc. CIFA 2010, Nancy, 2010.
- [Hilairet et al. 2012] M. Hilairet, V. Tanasa, O. Bethoux and D. Normand-Cyrot. *A passivity-based controller with charge estimation for coordination of converters in a fuel cell System*. In 8th PP&PSC (Power Plant and Power System Control) Symposium, Toulouse, France., 2-5 September 2012.
- [Hou et al. 1997] Ling Hou, A.N. Michel and Hui Ye. *Some qualitative properties of sampled-data control systems*. IEEE Trans. Automatic Control, vol. 42, no. 12, pages 1721–1725, dec 1997.
- [Hu & Michel 1999] Bo Hu and A.N. Michel. *Some qualitative properties of multirate digital control systems*. Automatic Control, IEEE Transactions on, vol. 44, no. 4, pages 765 –770, apr 1999.
- [Ieko et al. 1996] T. Ieko, Y. Ochi, K. Kanai, Hori N. and Okamoto K.I. *Digital redesign methods based on plant input mapping and a new discrete-time model*. In Decision and Control, 1996., Proceedings of the 35th IEEE, volume 2, pages 1569 –1574 vol.2, dec 1996.
- [Iplikci 2010] S. Iplikci. *A support vector machine based control application to the experimental three-tank system*. ISA Transactions, vol. 49, no. 3, pages 376–386, 2010.
- [Isidori 1995] A. Isidori. *Nonlinear control systems*. Springer-Verlag, 1995.
- [Jirstrand 1997] M. Jirstrand. *Nonlinear Control System Design by Quantifier Elimination*. Journal of Symbolic Computation, vol. 24, pages 137–152, 1997.
- [Johansson 2000] K.H. Johansson. *The quadruple-tank process: a multivariable laboratory process with an adjustable zero*. IEEE Transactions on Control Systems Technology, vol. 8, no. 3, pages 456–465, 2000.
- [Kameneva & Nešić 2010] T Kameneva and D. Nešić. *Robustness of nonlinear control systems with quantized feedback*. Nonlinear Analysis: Hybrid Systems, vol. 4, no. 2, pages 306–318, 2010.
- [Karafyllis & Krstic 2011] I. Karafyllis and M. Krstic. *Nonlinear Stabilization under Sampled and Delayed Measurements, and with Inputs Subject to Delay and Zero-Order Hold*. Automatic Control, IEEE Transactions on, vol. PP, no. 99, page 1, 2011.
- [Keller & Anderson 1992] J.P. Keller and B.D.O. Anderson. *A new approach to the discretization of continuous-time controllers*. Automatic Control, IEEE Transactions on, vol. 37, pages 214 – 223, 1992.

- [Khalil 1996] H.K. Khalil. *Nonlinear systems*. Prentice-Hall, Englewood Cliffs, NJ., 1996.
- [Khalil 2004] H.K. Khalil. *Performance recovery under output-feedback sampled-data stabilization of a class of nonlinear systems*. IEEE Transactions on Automatic Control, vol. 49, pages 2173–2184, 2004.
- [Kojima *et al.* 2010] K. Kojima, T. Oguchi, A. Alvarez-Aguirre and H. Nijmeijer. *Predictor-Based Tracking Control of a Mobile Robot with Time-Delays*. In 8th IFAC Symposium on Nonlinear Control Systems, Bologna, Italy, September 1-3, 2010.
- [Kokotovic *et al.* 1986] P.V. Kokotovic, H.K. Khalil and J. O' Reilly. *Singular perturbation methods in control: Analysis and design*. Academic Press, New York, 1986.
- [Kottenstette *et al.* 2010] N. Kottenstette, J. Porter, G. Karsai and J. Sztipanovits. *Discrete-time IDA-passivity based control of coupled tank processes subject to actuator saturation*. In Resilient Control Systems (ISRCS), 2010 3rd International Symposium on, pages 115 –120, aug. 2010.
- [Krstic *et al.* 1992] M. Krstic, I. Kanellakopoulos and P.V. Kokotović. *Nonlinear Design of Adaptive Controllers for Linear Systems*. IEEE Trans. Automatic Control, vol. 39, pages 738–752, 1992.
- [LaSalle & Lefschetz 1961] J.P. LaSalle and S. Lefschetz. *Stability by liapunov's direct method: with applications*. Mathematics in science and engineering. Academic Press, 1961.
- [Ledyeva & Sontag 1999] Y. S. Ledyeva and E. D. Sontag. *A Lyapunov characterization of robust stabilization*. Nonlinear analysis, vol. 37, pages 813–840, 1999.
- [Lee 2006] J. Lee. *Introduction to smooth manifolds*. graduate texts in mathematics. Springer-Verlag, Berlin, Germany, 2006.
- [Liberzon 2001] D. Liberzon. *A hybrid control framework for systems with quantization*. In Decision and Control, 2001. Proceedings of the 40th IEEE Conference on, volume 2, pages 1217 –1222 vol.2, 2001.
- [Liberzon 2006] D. Liberzon. *Quantization, time delays, and nonlinear stabilization*. Automatic Control, IEEE Transactions on, vol. 51, no. 7, pages 1190 – 1195, july 2006.
- [Malisoff & Mazenc 2009] M. Malisoff and F. Mazenc. *Constructions of strict lyapunov functions*. Communications and Control Engineering. Springer, 2009.
- [Mattei & Monaco 2012] G. Mattei and S. Monaco. *Robust Backstepping Control of Missile Lateral and Rolling Motions in the Presence of Unmatched Uncertainties*. In Proceedings of 51th Conference on Decision and Control, Maui, Hawaii, 2012.

- [Monaco & Normand-Cyrot 1983] S. Monaco and D. Normand-Cyrot. *Formal power series and input output linearization of nonlinear discrete time systems*. In Proc. 22nd IEEE-CDC, San Antonio, pages 665–670, 1983.
- [Monaco & Normand-Cyrot 1984a] S. Monaco and D. Normand-Cyrot. *Input-Output Maps of Nonlinear Discrete-Time Systems*. Encyclopedia of Systems and Control, 1984.
- [Monaco & Normand-Cyrot 1984b] S. Monaco and D. Normand-Cyrot. *Invariant distributions for nonlinear discrete time systems*. Syst. and Contr. Lett., vol. 5, pages 191–196, 1984.
- [Monaco & Normand-Cyrot 1984c] S. Monaco and D. Normand-Cyrot. *On the realization of nonlinear discrete time systems*. Syst. and Contr. Lett., vol. 5, pages 145–152, 1984.
- [Monaco & Normand-Cyrot 1986] S. Monaco and D. Normand-Cyrot. *Approximation entrée sortie d'un système non linéaire continu par un système discret*. Lect. Notes in Cont. and Info. Sciences (A.Bensoussan et J.L.Lions, Eds.), pages 354–364, 1986.
- [Monaco & Normand-Cyrot 1992] S. Monaco and D. Normand-Cyrot. *An introduction to motion planning under multirate digital control*. In Decision and Control, 1992., Proceedings of the 31st IEEE Conference on, pages 1780–1785 vol.2, 1992.
- [Monaco & Normand-Cyrot 2001] S. Monaco and D. Normand-Cyrot. *Issues on nonlinear digital systems*. Semi-Plenary Conference, ECC-01, Porto, Invited Paper, 2001. Special Issue , European Journal of Control, 7-2,3 : 170-178, Hermès Sciences, Paris.
- [Monaco & Normand-Cyrot 2006] S. Monaco and D. Normand-Cyrot. *Input-state matching under digital control*. In Decision and Control, 45th IEEE Conference on, pages 1806–1811, dec. 2006.
- [Monaco & Normand-Cyrot 2007] S. Monaco and D. Normand-Cyrot. *Advanced Tools for Nonlinear Sampled-Data Systems, Analysis and Control, Mini-Tutorial*. ECC-07, Kos, Invited Paper, 2007. Special Issue "Fundamental Issues in Control", European Journal of Control, 13-2,3 : 221-241, Hermès Sciences, Paris.
- [Monaco & Normand-Cyrot 2009] S. Monaco and D. Normand-Cyrot. *Méthodologies d'Analyse et de Synthèse pour le Systèmes Echantillonnés*. Automatique Avancée et Informatique Appliquée (P. Borne, M. Benrejeb, F. Filip, D. Popescu Eds) Editions de l'Académie Roumaine, pages 33–48, 2009.
- [Monaco & Normand-Cyrot 2012] S. Monaco and D. Normand-Cyrot. *Nonlinear optimal stabilizing control in discrete-time*. In Proc. ACC, Montreal, Canada, 2012.

- [Monaco *et al.* 1986] S. Monaco, D. Normand-Cyrot and S. Stornelli. *On the linearizing feedback in nonlinear sampled data control schemes*. In Proc. 25th IEEE-CDC, Athens, pages 2056–2060, 1986.
- [Monaco *et al.* 2007] S. Monaco, C. Normand-Cyrot and C. Califano. *From Chronological Calculus to Exponential Representations of Continuous and Discrete-Time Dynamics: A Lie-Algebraic Approach*. Automatic Control, IEEE Transactions on, vol. 52, no. 12, pages 2227–2241, 2007.
- [Monaco *et al.* 2009] S. Monaco, D. Normand-Cyrot and F. Tiefensee. *Nonlinear port controlled hamiltonian systems under sampling*. In Proc. 48th IEEE CDC, pages 1782–1787, Shanghai, 2009.
- [Monaco *et al.* 2010] S. Monaco, D. Normand-Cyrot and F. Tiefensee. *Sampled-data redesign of stabilizing feedback*. In Proc. ACC, Baltimore, pages 1805–1810, 2010.
- [Monaco *et al.* 2011] S. Monaco, D. Normand-Cyrot and F. Tiefensee. *Sampled-Data Stabilization; A PBC Approach*. IEEE Trans. Automatic Control, vol. 56, pages 907–912, 2011.
- [Monaco *et al.* 2012] S. Monaco, C. Normand-Cyrot and V. Tanasa. *Digital stabilization of delayed-input strict-feedforward dynamics*. In 51th Conference on Decision and Control (CDC), Maui, Hawaii, December, 10-13 2012.
- [Monroe 1962] A.J. Monroe. *Digital processes for sampled data systems*. Wiley, 1962.
- [Nešić & Grüne 2005] D. Nešić and L. Grüne. *Lyapunov based continuous-time controller redesign for sampled-data implementation*. Automatica, vol. 41, pages 1143–1156, 2005.
- [Nešić *et al.* 1999] D. Nešić, A.R. Teel and P.V. Kokotović. *Sufficient conditions for stabilization of sampled-data nonlinear systems via discrete-time approximations*. Syst. Control Letters, vol. 38, pages 259–270, 1999.
- [Nešić & Teel 2001] D. Nešić and A.R. Teel. *Backstepping on the Euler approximate model for stabilization of sampled-data nonlinear systems*. In Decision and Control, 2001. Proceedings of the 40th IEEE Conference on, volume 2, pages 1737–1742 vol.2, 2001.
- [Nešić & Teel 2004a] D. Nešić and A.R. Teel. *A framework for stabilization of nonlinear sampled-data systems based on their approximate discrete-time models*. IEEE Transactions on Automatic Control, vol. 49, pages 1103–1122, 2004.
- [Nešić & Teel 2004b] D. Nešić and A.R. Teel. *Input-output stability properties of networked control systems*. Automatic Control, IEEE Transactions on, vol. 49, no. 10, pages 1650–1667, oct. 2004.
- [Nešić & Teel 2006] D. Nešić and AR Teel. *Stabilization of sampled-data nonlinear systems via backstepping on their Euler approximate model*. Automatica, vol. 42, pages 1801–1808, 2006.

- [Nešić *et al.* 2009] D. Nešić, A.R. Teel and D. Carnavalle. *Explicit computation of the sampling period in emulations of controllers for nonlinear sampled-data systems*. IEEE Transactions on Automatic Control, vol. 54, pages 619–624, 2009.
- [Niculescu & Gu 2004] S.I. Niculescu and K. Gu. *Advances in time-delay systems*. Lecture Notes in Computational Science and Engineering. Springer-Verlag, 2004.
- [Normand-Cyrot 1982] D. Normand-Cyrot. *An algebraic approach to the input-output description of nonlinear discrete time systems*. In Proc. of American Control Conference, pages 466–471, 1982.
- [Ohtani *et al.* 1994] T. Ohtani, M. Fukuzawa and Masubuchi M. *A CAD system for nonlinear control system design using "Mathematica"*. In IEEE/IFAC Joint Symp. on CACSD, pages 197–204, 1994.
- [Ortega & Spong 1989] R. Ortega and M. Spong. *Adaptive motion control of rigid robots : A tutorial*. Automatica, vol. 25(6), pages 877–888, 1989.
- [Ortega *et al.* 1998] R. Ortega, A. Loria, P. J. Nicklasson and H. Sira-Ramírez. *Passivity-based Control of Euler-Lagrange Systems: Mechanical, Electrical and Electromechanical Applications*. Series Communications and Control Engineering, 1998.
- [Ortega *et al.* 2002] R. Ortega, A. van der Schaft, B. Maschke and G. Escobar. *Interconnection and damping assignment passivity-based control of port-controlled Hamiltonian systems*. Automatica, vol. 38(4), pages 585–596, 2002.
- [Oshima *et al.* 1991] M. Oshima, S. Hara and G. Yamamoto. *A Cad System for Sampled-Data Control Systems Based on Hybrid State-Space Model*. In Proc. KACC '91, pages 1377–1382, 1991.
- [Owen *et al.* 1990] D. H. Owen, Y. Zheng and S. A. Billings. *Fast sampling and stability of nonlinear sampled-data systems: Part 1. existence theorems*. IMA J. Math. Inform., vol. 7, pages 1–11, 1990.
- [Pan *et al.* 2005] Haizhou Pan, Hong Wong, Vikram Kapila and S. de Queiroz Marcio. *Experimental validation of a nonlinear backstepping liquid level controller for a state coupled two tank system*. Control Engineering Practice, vol. 13, no. 1, pages 27 – 40, 2005.
- [Paromtchik & Laugier 1996] I.E. Paromtchik and C. Laugier. *Autonomous parallel parking of a nonholonomic vehicle*. In Intelligent Vehicles Symposium, 1996., Proceedings of the 1996 IEEE, pages 13 –18, sep 1996.
- [Perruquetti & Barbot 2002] W. Perruquetti and J.P. Barbot. *Sliding mode control in engineering*. Control engineering. Taylor & Francis, 2002.

- [Polyakov *et al.* 2006] K. Polyakov, E. Rosenwasser and Lampe B. *DIRECTSD 3.0 toolbox for MATLAB: further progress in polynomial design of sampled-data systems*. In Proc. of the 2006 IEEE Conference on CACSD, pages 1946–1951, 2006.
- [Popov 1973] V. M. Popov. *Hyperstability of control systems*. Springer-Verlag, Berlin, 1973.
- [Postoyan 2009] R. Postoyan. *Commande et construction d'observateurs pour les systèmes non linéaires incertains à données échantillonnées et en réseau*. PhD thesis, Université Paris-Sud, LSS-CNRS, SUPELEC, France, 2009.
- [Poza *et al.* 2008] Francesc Pozo, Fayçal Ikhouane and José Rodellar. *Numerical issues in backstepping control: Sensitivity and parameter tuning*. Journal of the Franklin Institute, vol. 345, no. 8, pages 891 – 905, 2008.
- [Praly *et al.* 1991] L. Praly, B. Andrea-Novel and J.-M. Coron. *Lyapunov design of stabilizing controllers for cascaded systems*. Automatic Control, IEEE Transactions on, vol. 36, no. 10, pages 1177 –1181, oct 1991.
- [Rasvan & Stefan 2007] V. Rasvan and R. Stefan. *Systèmes non linéaires: théorie et applications*. Collection Automatique de base. Hermès Science Publications, 2007.
- [Rodrigues-Millan *et al.* 1997] J. Rodrigues-Millan, Y. Alzuru, J. Cardillo and J. Yepez. *NLFeedback 2.0: a symbolic computation tool for the design of extended controllers and observers for nonlinear control systems with stabilizable and detectable linearization*. In Proc. of the American Control Conference, 1997.
- [Samaan *et al.* 1989] M. Samaan, I.D. Landau, M. M'Saad and B. Manguin. *EXPERT-AD: an environment for off-line and real time computer aided control design*. In Computer-Aided Control System Design, 1989., IEEE Control Systems Society Workshop on, pages 138 –142, dec 1989.
- [Sandberg 1967] I.W. Sandberg. *Floating-Point Round-off Accumulation in Digital Filter Realization*. Bell Syst. Tech. J., vol. 46, pages 1775–1791, 1967.
- [Santina & Stubberud 2005] Mohammed S. Santina and Allen R. Stubberud. *Basics of Sampling and Quantization*. In Dimitrios Hristu-Varsakelis, William S. Levine and William S. Levine, editeurs, Handbook of Networked and Embedded Control Systems, Control Engineering, pages 45–69. Birkhäuser Boston, 2005.
- [Sastry 1999] Shankar Sastry. *Nonlinear systems - analysis, stability and control*, 1999. Springer-Verlag, New York, 1999.

- [Sbarbaro & Ortega 2005] D. Sbarbaro and R. Ortega. *Averaging Level Control of Multiple Tanks: A Passivity Based Approach*. Proceedings of the 44th IEEE Conference on Decision and Control, pages 7384–7389, 2005.
- [Sepulchre *et al.* 1997] R. Sepulchre, M. Janković and P.V. Kokotović. *Constructive nonlinear control*. Springer New York, 1997.
- [Slaughter 1964] J. Slaughter. *Quantization errors in digital control systems*. Automatic Control, IEEE Transactions on, vol. 9, no. 1, pages 70 – 74, jan 1964.
- [Sontag 1983] E. D. Sontag. *A Lyapunov-like characterization of asymptotic controll.* Siam J. on Control and Optimization, vol. 21, pages 462–471, 1983.
- [Tanasa *et al.* 2012] V. Tanasa, S. Monaco and C. Normand-Cyrot. *Nonlinear optimal stabilizing control under sampling*. In 51th Conference on Decision and Control (CDC), Maui, Hawaii, December, 10-13 2012.
- [Teel *et al.* 1998] A.R. Teel, D. Nešić, and P.V. Kokotović. *A note on input-to-state stability of sampled-data nonlinear systems*. In Decision and Control, 37th IEEE Conference on, 1998.
- [Thounthong *et al.* 2005] P. Thounthong, S. Raël and Davat B. *Supercapacitors as an energy storage for fuel cell automotive hybrid electrical system*. International Journal of Electrical Engineering in Transportation, vol. 1, 2005.
- [Tiefensee *et al.* 2009] F. Tiefensee, S. Monaco and D. Normand-Cyrot. *Lyapunov design under sampling for a synchronous machine*. In Proc. EUCA-ECC, Budapest, Hungary, pages 1775–1780, 2009.
- [Tiefensee *et al.* 2010a] F. Tiefensee, M. Hilairret, D. Normand-Cyrot and O. Bethoux. *Sampled-data energetic management of a Fuel Cell/Supercapacitor system*. In Proc. Vehicle Power and Propulsion Conference (VPPC), pages 1–6, 2010.
- [Tiefensee *et al.* 2010b] F. Tiefensee, S. Monaco and D. Normand-Cyrot. *IDA - PBC under sampling for Port-Controlled Hamiltonian systems*. In Proc. ACC, Baltimore, pages 1811–1816, 2010.
- [Tiefensee 2010] F. Tiefensee. *Méthodes asymptotiques pour la commande des systèmes non linéaires échantillonnés*. PhD thesis, Paris-Sud 11 University, 2010.
- [Tou 1959] J.T. Tou. *Digital and sampled-data control systems*. McGraw-Hill, 1959.
- [Whidborne *et al.* 2006] J.F. Whidborne, J. Mckernan and Da-Wei Gu. *Kolmogorov-Chaitin Complexity of Digital Controller Implementations*. International Journal of Automation and Computing, vol. 3, pages 314–322, 2006.

[Widrow 1960] B. Widrow. *Statistical analysis of amplitude-quantized sampled-data systems*. Trans. Amer. Inst. Elec. Engrs., vol. 79, pages 555–568, jan 1960.

[Zheng *et al.* 1990] Y. Zheng, D. H. Owen and S. A. Billings. *Fast sampling and stability of nonlinear sampled-data systems: Part 1. sampling rate estimation*. IMA J. Math. Inform., vol. 7, pages 13–33, 1990.

COLOPHON

This document was typeset using the typographical look-and-feel `classicthesis` developed by André Miede. The style was inspired by Robert Bringhurst's seminal book on typography "*The Elements of Typographic Style*". `classicthesis` is available for both \LaTeX and \LyX :

<http://code.google.com/p/classicthesis/>