

# ILLUSTRATIONS

## Sommaire

- Bourguignon-les-Morey « Camp Romain » .....Pl. 1 à 37
- Hunderingen « Heuneburg».....Pl. 38 à 50
- Salins-les-Bains « Camp du Château ».....Pl. 51 à 72
- Messein « Camp d’Affrique ».....Pl. 73 à 103
- Illfurth « Britzgyberg ».....Pl. 104 à 123
- Posieux « Châtillon-sur-Glâne ».....Pl. 124 à 133
- Chassey « Le Camp ».....Pl. 134 à 151
- Vix « Mont Lassois ».....Pl. 152 à 185
- Mancey « Charmes ».....Pl. 186 à 190
- Illfurth « Britzgyberg-Buegerlen ».....Pl. 191 à 194

# Bourguignon-les-Morey

## Camp de César

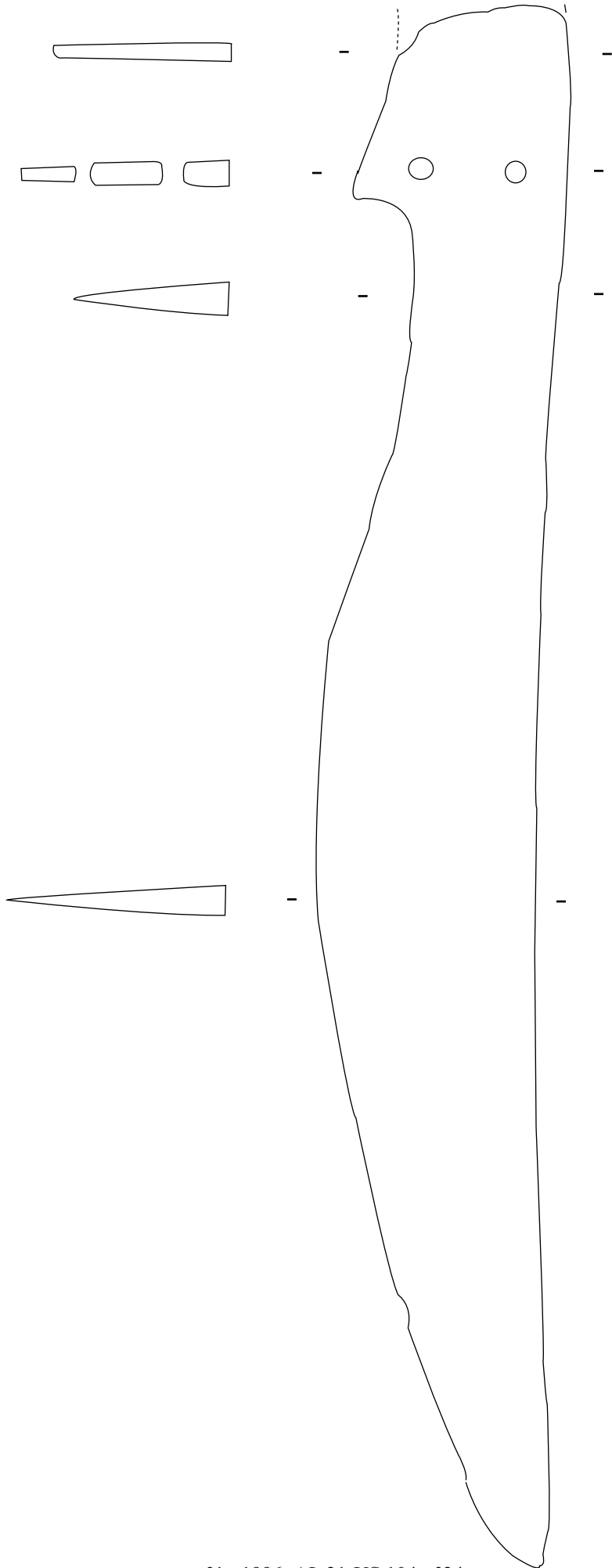

n°1 : 1996- AL 21-US 104-n°24

Fer

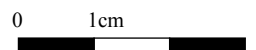

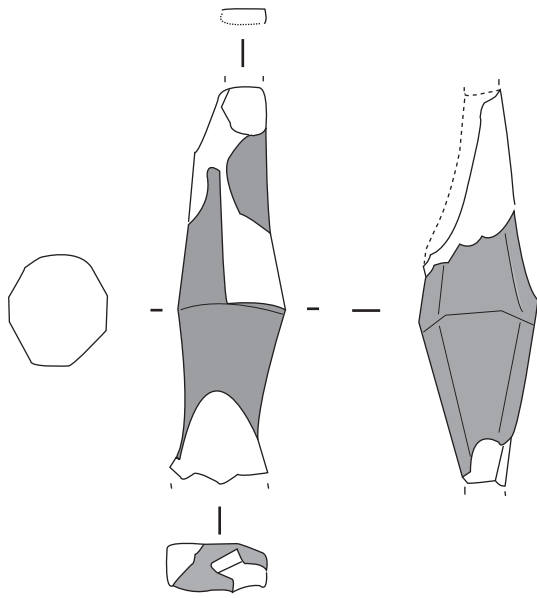

n°1 : AJ 22-US 96-n°11

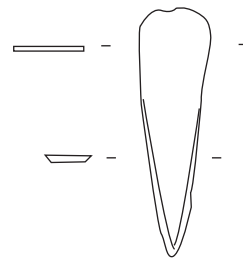

n°2 : 1998-AX25-US 140-n°64

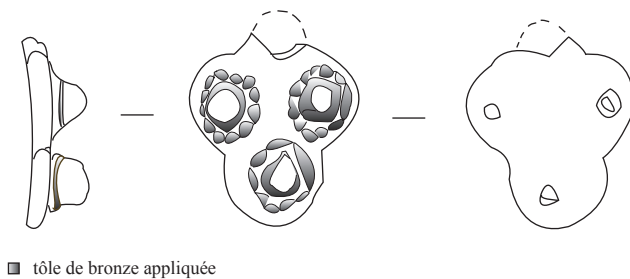

n°3 : 1999-Rempart Ouest-n°11

1-3 : fer ; 2 : bronze

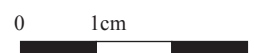

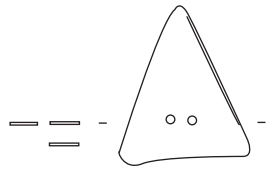

n°1:1998-AX23-US 139

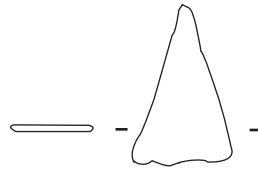

n°2 : 1993-Q44-US 2013-n°26

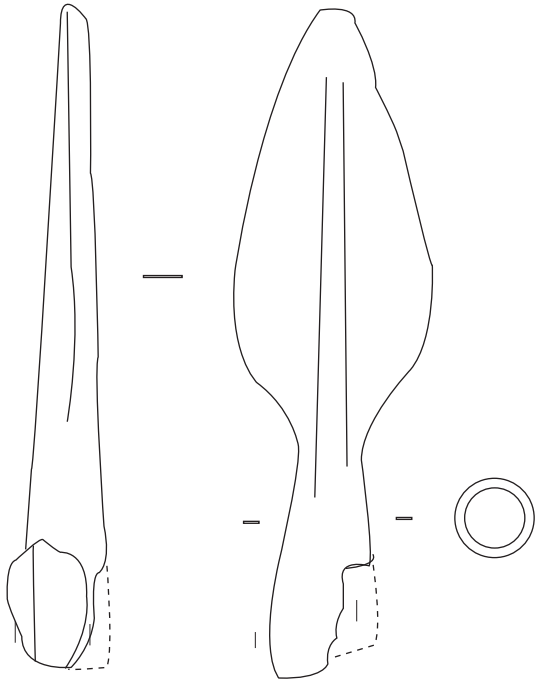

d'après V. Ganard

n°3 : 1992-M50-US 2005-n°11

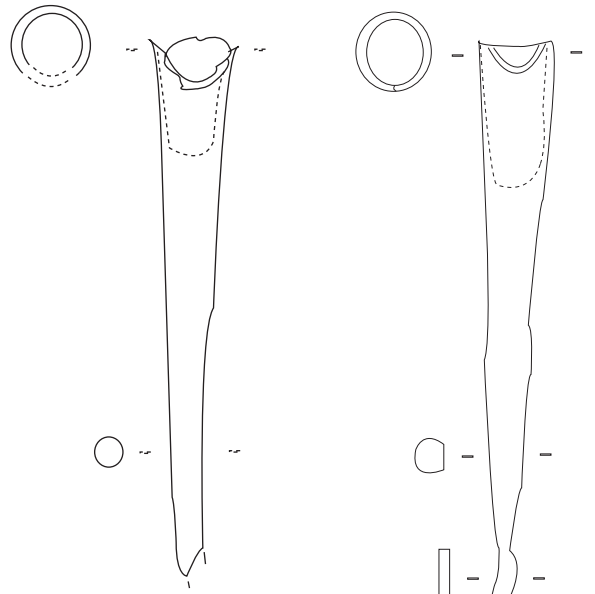

n°4 : 1996-AN 22-US 93-n°34

n°5 : 1999-  
rempart est-n°10

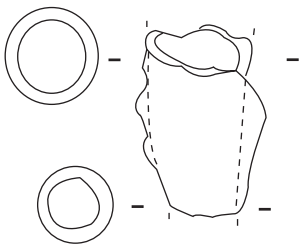

n°6 : 1997-AY 26-US 119-n°26

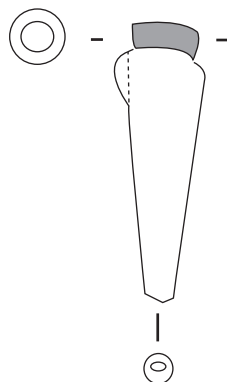

■ restes ligneux

n°7 : 1997-AK 22-US 101-n°60

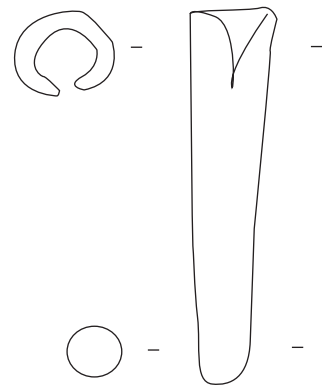

n°8 : 2001-rempart sud-entrée-  
BB18-US 124-n°1

2 à 8 : fer ; 1 : bronze

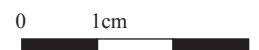

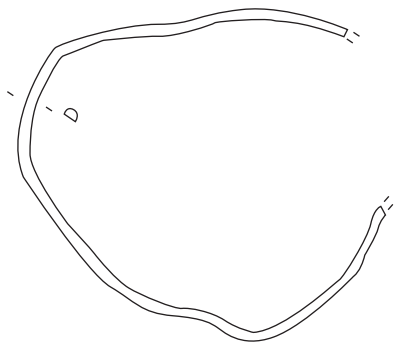

n°1 : 1999-P37-US 53b-n°15

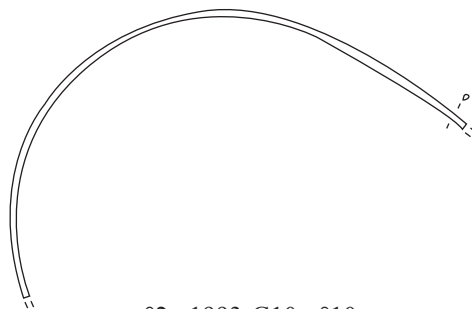

n°2 : 1993-G10-n°10

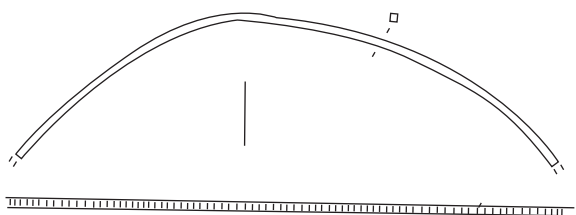

n°3 : 1993-W22-US 13

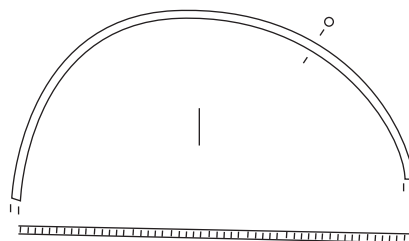

n°4 : 1994-L28-US 23-n°2

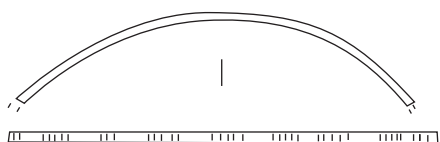

n°5 : 1992-M50-US 2007

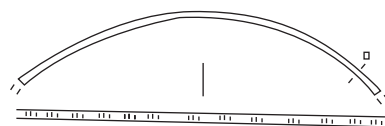

n°6 : 1993-U26-US 14-n°90

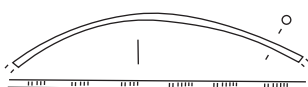

n°7 : 1993-Q22-US 13

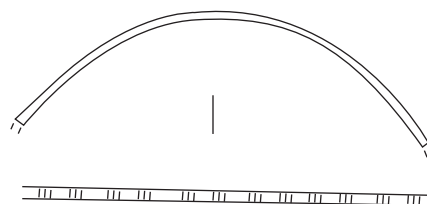

n°8 : 1994-M22-US 29-n°1

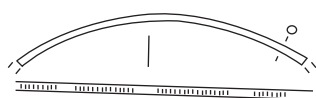

n°9 : 1992-U24-US 14

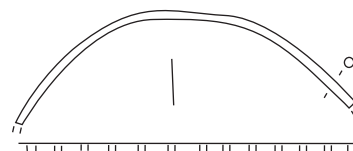

n°10 : 1993-U22-US 13

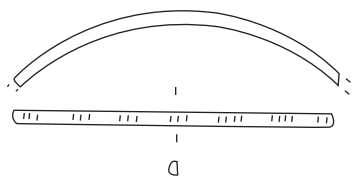

n°11 : 2002-AU22-US 282

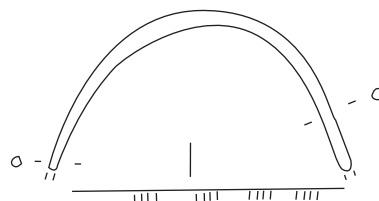

n°12 : 1997-AK22-US 104-n°84

1 à 12 : bronze

0 1cm



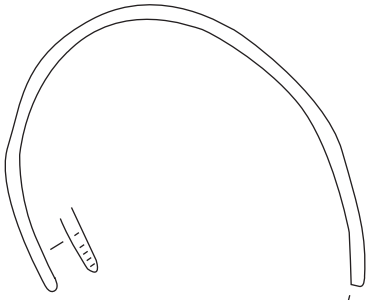

n°1 : 1998-AY23-n°1

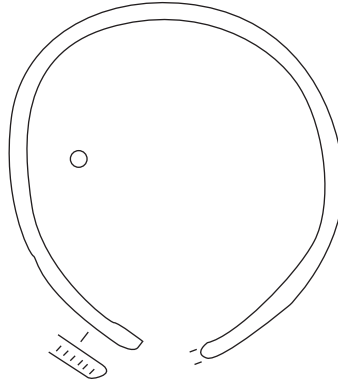

n°2 : 1999-R39-US 53b-n°14

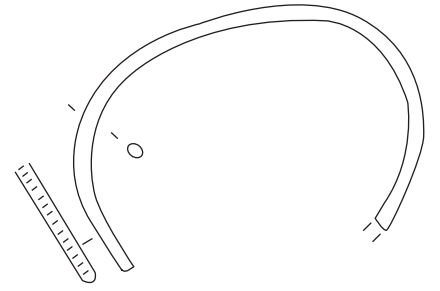

n°3 : 1997-AK24-US 84-n°50

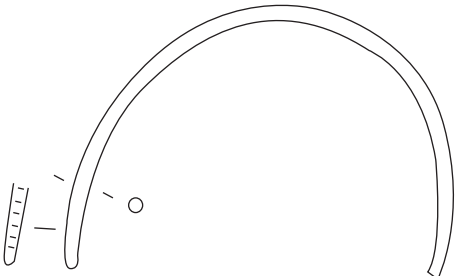

n°4 : 1993-M44-13-n°57

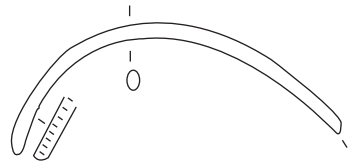

n°5 : 1996-AN25-US 84-n°14

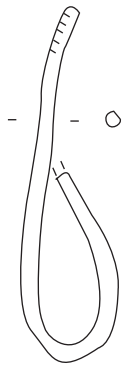

n°9 : 1997-AZ26-US 119-n°17

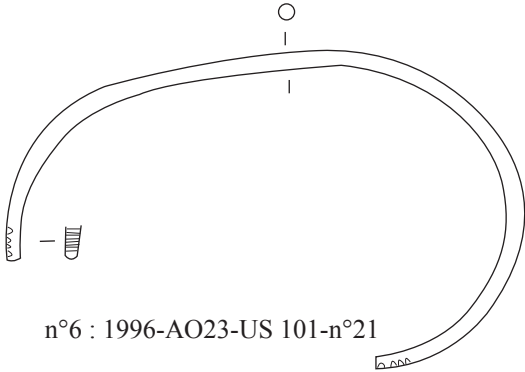

n°6 : 1996-AO23-US 101-n°21

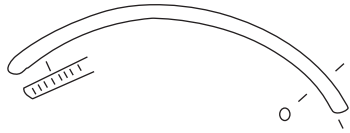

n°7 : AO24-US 02-n°4



n°8 : 1993-U28-US 14-n°62

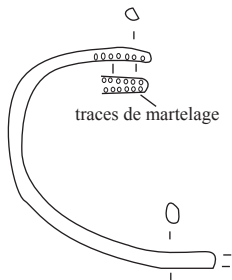

n°10 : 1998-Q33-US 53b-n°5

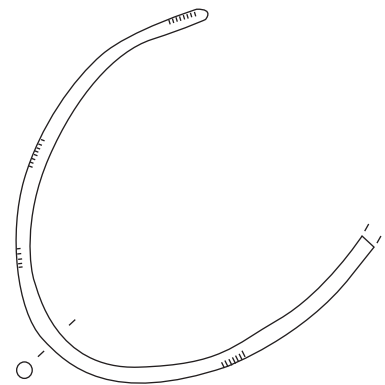

n°11 : 1996-AL22-US 101-n°25

1 à 11 : bronze

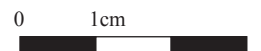

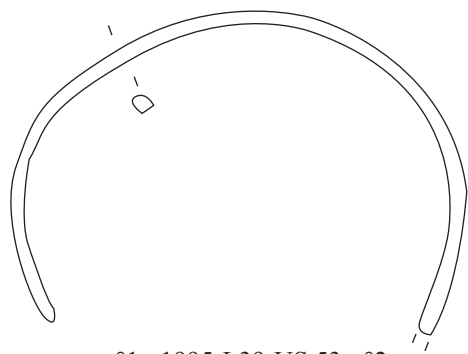

n°1 : 1995-L39-US 53-n°2

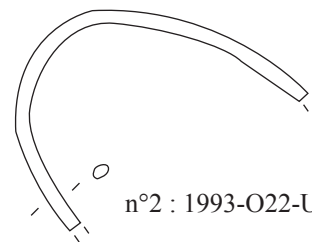

n°2 : 1993-O22-US 02

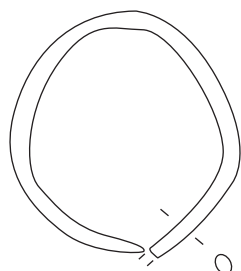

n°4 : 1996-AN23-US 101-n°25



n°5 : 1994-L21-US 30-n°3

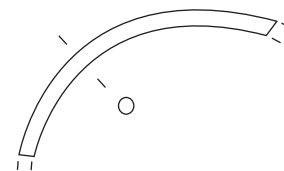

n°3 : Sans provenance

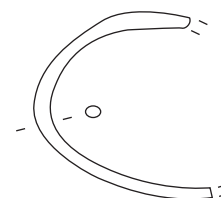

n°6 : 1998-P33-US 53b-n°5

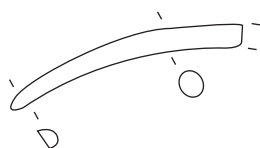

n°7 : 1996-AI21-US 97-n°4

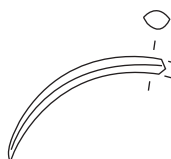

n°8 : 1993-K23-US 24-n°5

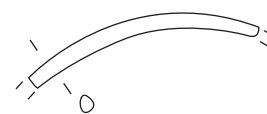

n°9 : 1997-AW26-US 119-n°12

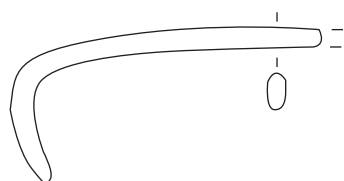

n°10 : 1998-S33-US 53-n°5

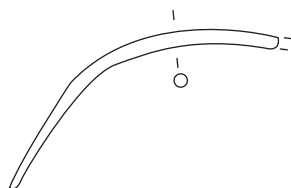

n°11 : 1999-N38-US 53-n°1



n°12 : 1992-U26-US 01



n°13 : 1993-O22-US 26-n°4



n°14 : 1994-L26-US 23

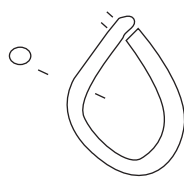

n°15 : 1997-AN25-US 119-n°21

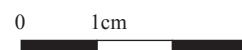

n°1 à 16 : bronze



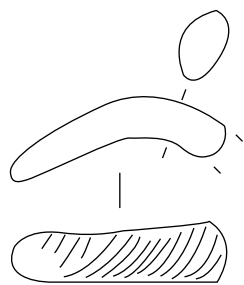

n°1 : 1999-US 174-n°10

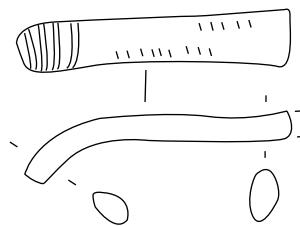

n°2 : 1996-AN24-US 84-n°12

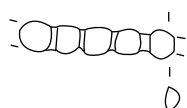

n°3 : 1993-M44-US 08-n°87

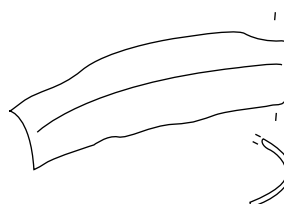

n°4 : 1994-J29-US 23

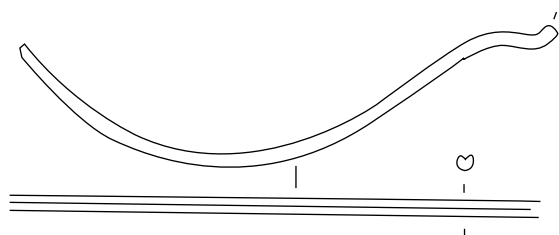

n°5 : 1998-T37-US 53-n°1

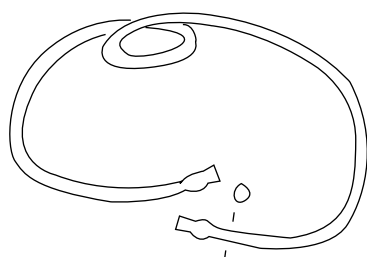

n°6 : 1992-US 00



n°7 : 1992-U24-US 05

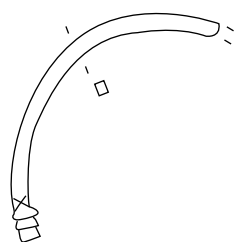

n°8 : 2001-AQ24-US 107-n°1

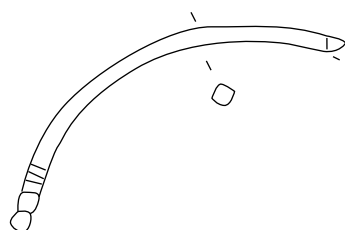

n°9 : 1998-BG22-US 141-n°1

n°1 à 9 : bronze

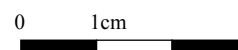

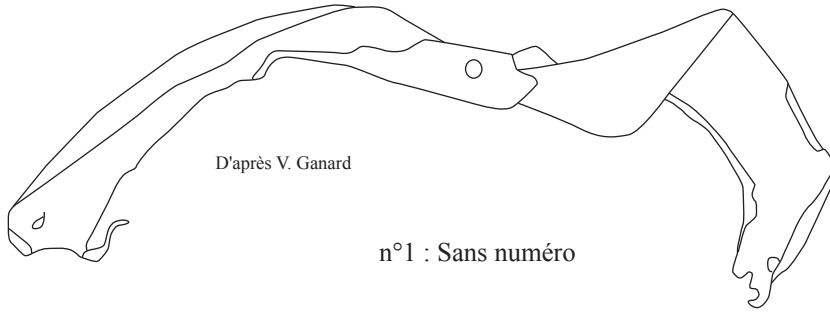
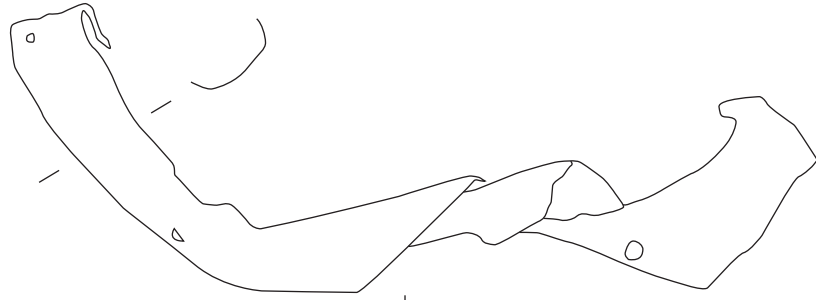

D'après V. Ganard

n°1 : Sans numéro

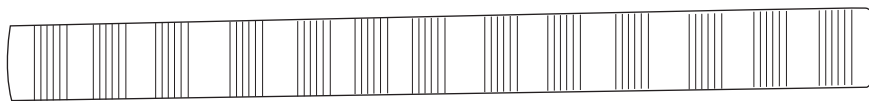
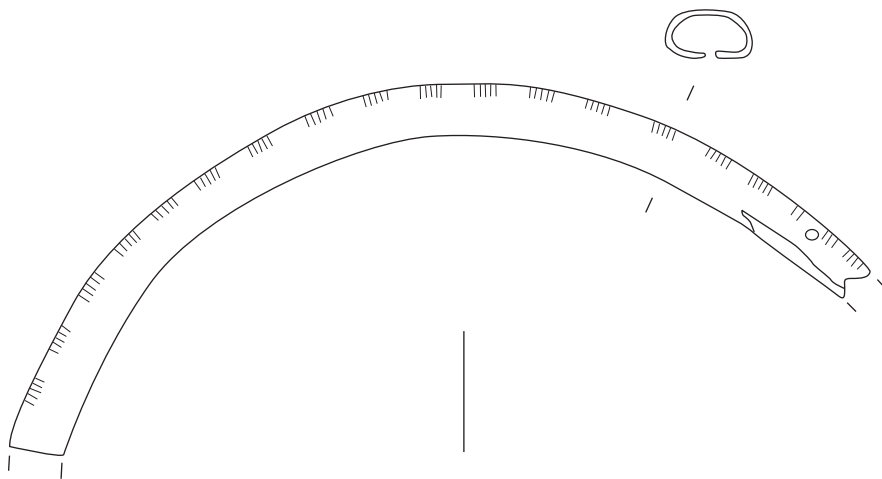

D'après V. Ganard

n°2 : MAN 6407-01

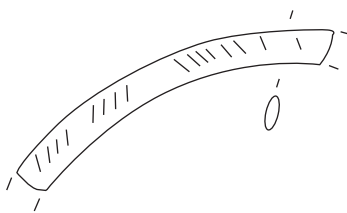

n°3 : 1996-M36-US 87-n°9

n°1 à 3 : bronze

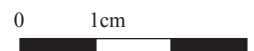



n°1 : 2002-AP23-US 282-n°27b

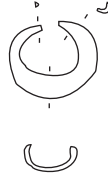

n°3 : 1994-J25-US 23-n°31



n°4 : 1994-J31-US 23-n°1

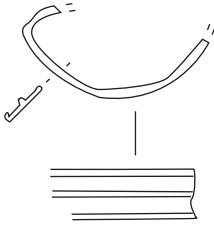

n°2 : 1994-H27-US 23



n°5 : 1996-AM23-US 84-n°14



n°6 : 1994-H27-US 23-n°2

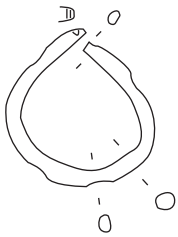

n°7 : 1992-W26-US 12

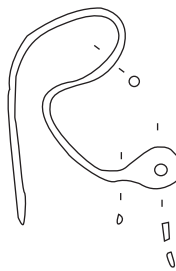

n°8 : 2001-AR25-US 108-n°2

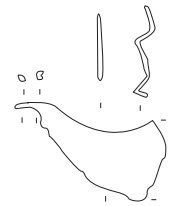

n°9 : 1997-AH20-US 100

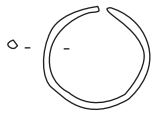

n°10 : 1993-Q46-US 13

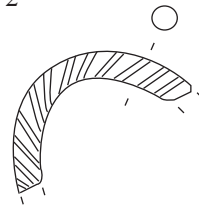

n°11 : 1994-K30-US 02-n°2

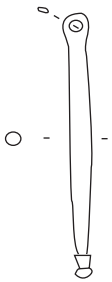

n°12 : 1996-AN24-US 84-n°5

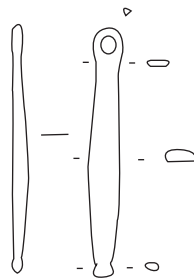

n°13 : 1997-AL 23-US 84-n°41

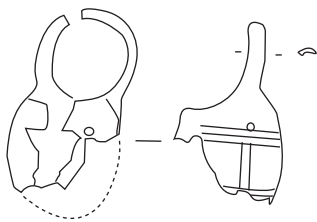

n°14 : 1993-M44-US 13-n°51



n°15 : 1996- (dalles)-US 93-n°28

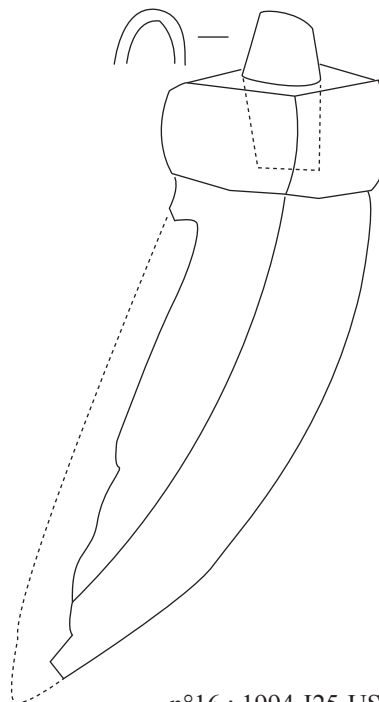

n°16 : 1994-I25-US 23-n°1

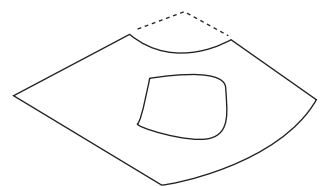

n°17 : 1994-K 26-US 23-n°3

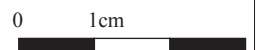

n°1 à 14 : bronze ; 17 : fer ; 15-16 : os

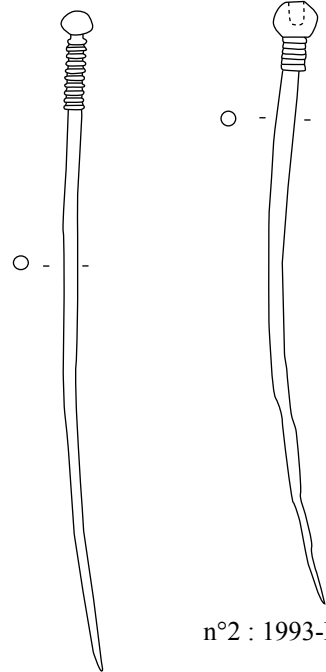

n°1 : 1994-H27-US 23-n°3

n°2 : 1993-M23-US 26

n°3 : 1994-J25-US 22-n°2

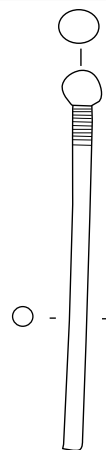

n°4 : MAN 6397

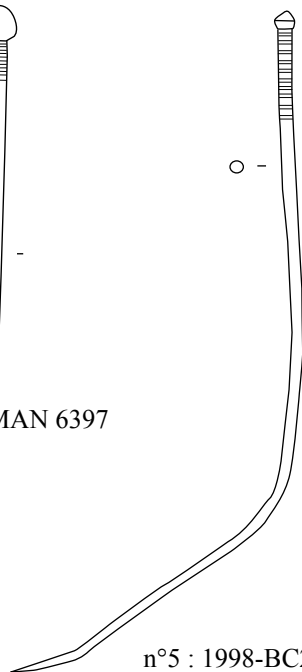

n°5 : 1998-BC22-n°2

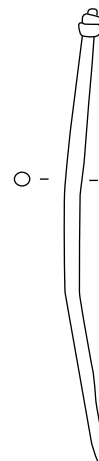

n°6 : RE 43

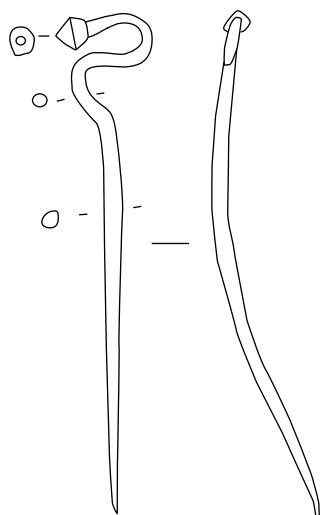

n°6 : 1996-fouilles  
anciennes



n°7 : 1998-BE20-  
US124-n°1

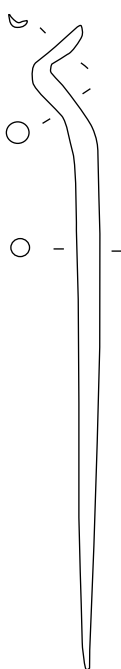

n°8 : M25-US 22

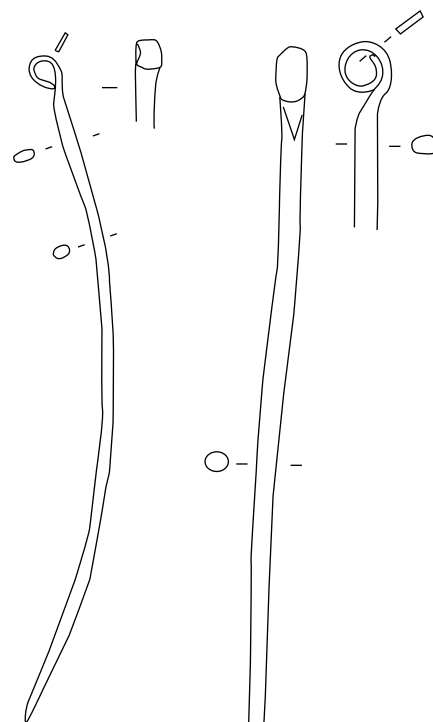

n°9 : 1993-H23-  
US 13-n°43

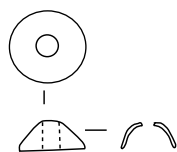

n°10 : 1998-O35-US 53b-n°3

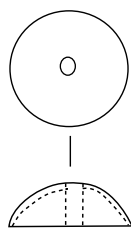

n°11 : 1996-AI 22-US 100-n°35

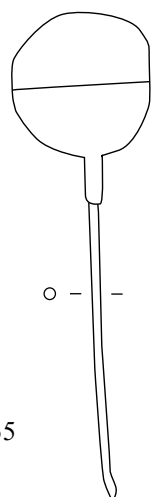

n°12 : MAN 6434

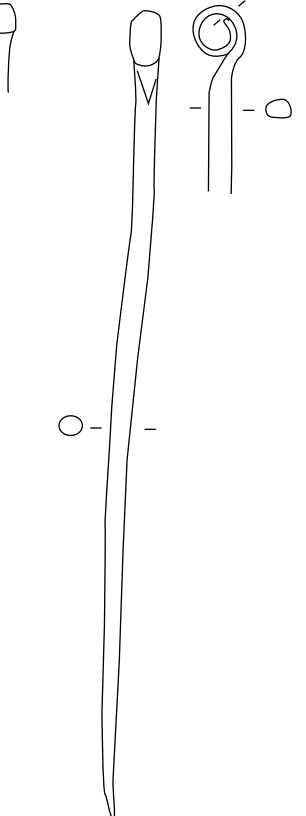

n°13 : 1997-BB25-US 119-  
n°21

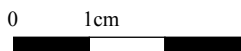

n°1 à 13 : bronze sauf n°4-6-8

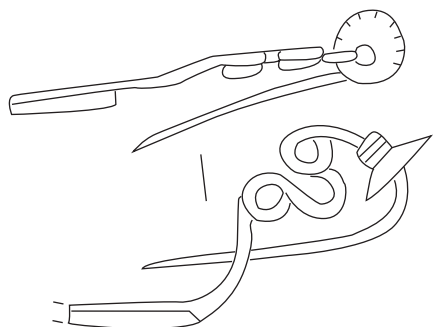

d'après V. Ganard n°1 : MAN 6391

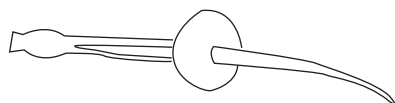

d'après V.Merle n°3 : 1993-M24- US 23-n°15

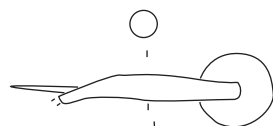

d'après V.Merle n°5 : 1993-S22-US 12-n°72

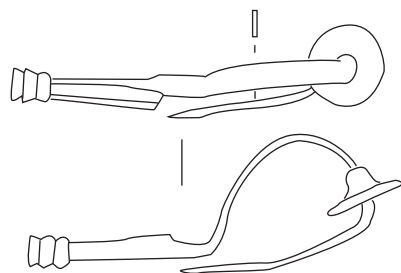

d'après V.Merle n°7 : 1993-O22-US 12-n°25

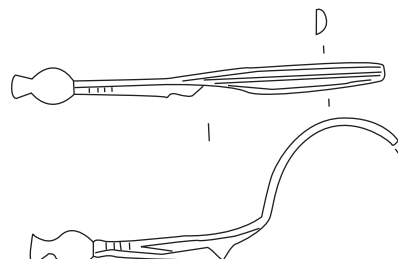

d'après V.Merle n°2 : 1993-M24-US 23-n°1

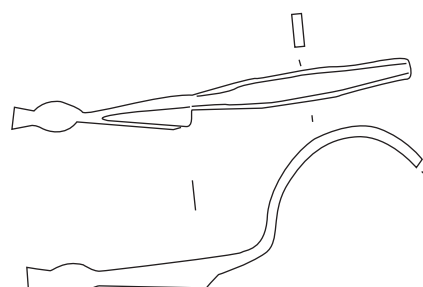

d'après V.Merle n°4 : 1989-sond.2



d'après V.Merle n°6 : 1992-K51-US 2003-n°10

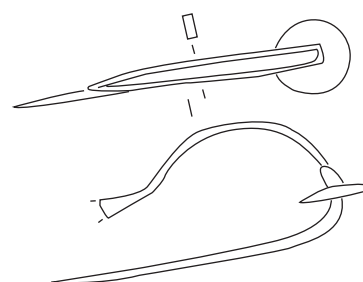

d'après V.Merle n°8 : Sans numéro

n°1 à 8 : bronze

0 1cm



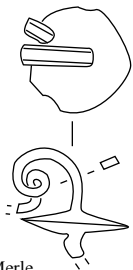

d'après V.Merle

n°1 : 1992-W24-US 12

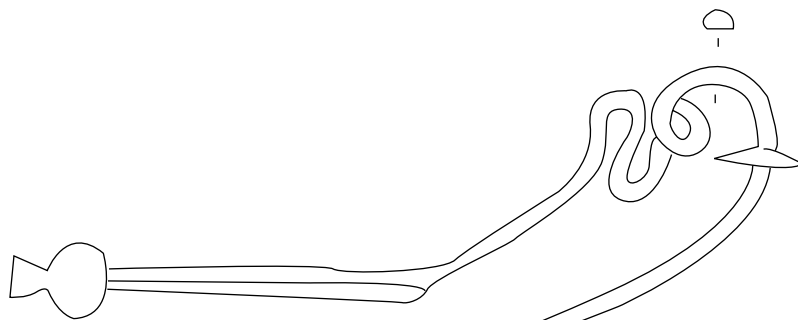

d'après V. Ganard

n°2 : MAN 6390-01

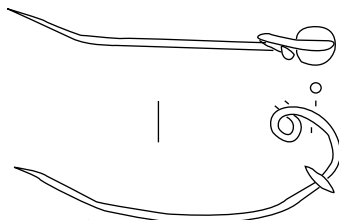

d'après V.Merle

n°3 : 1993-O22-US 02-n°31

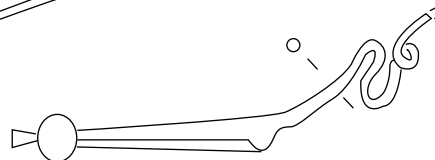

d'après V. Ganard

n°4 : 1997-L35-US 56

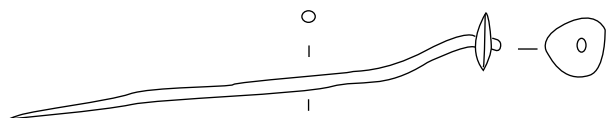

d'après V.Merle

n°5 : 1997-AK22-US 84b

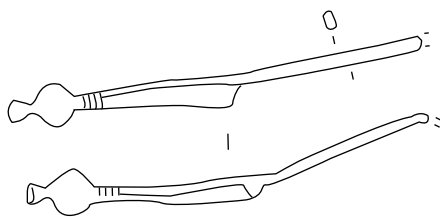

d'après V.Merle

n°6 : 1996-AM22-US 101-n°46

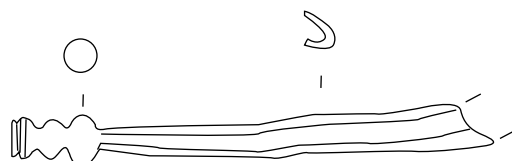

n°7 : 1999-Q38-US 174-n°27

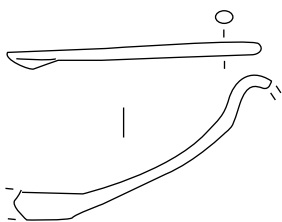

n°8 : 1997-AX25-US 108-n°1



d'après V.Merle

n°9 : 1994-H27-US 23-n°1

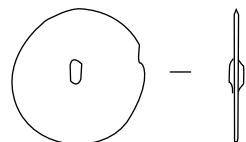

n°10 : 2001-AU24-US 139-n°9

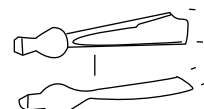

d'après V.Merle

n°12 : 1992-W26-US 14



d'après V.Merle

n°11 : 1994-J30-US 23-n°1

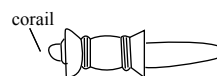

n°13 : 2001-AP25-US 140-n°22



n°14 : 2001-Z18-US 211-n°1

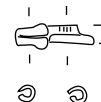

n°15 : 1999-Q37-US 53b-n°5

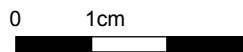

n°1 à 15 : bronze

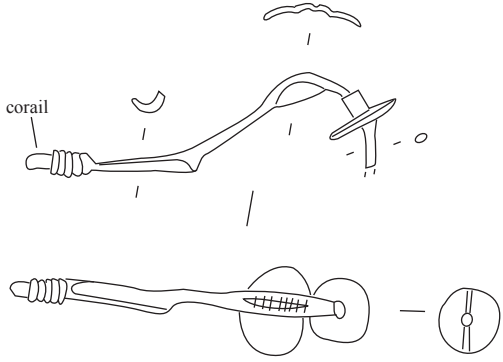

n°1 : 1997-AK22-US 84b

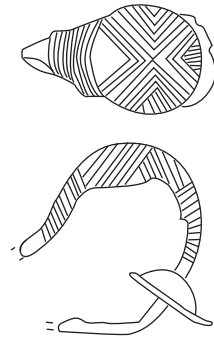

n°4 : 1995-L37-US 53-n°1

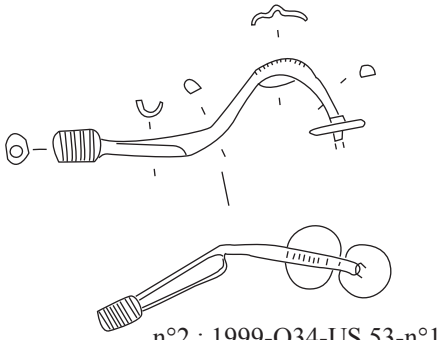

n°2 : 1999-O34-US 53-n°1

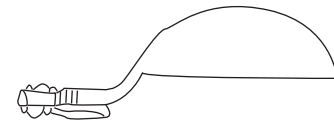
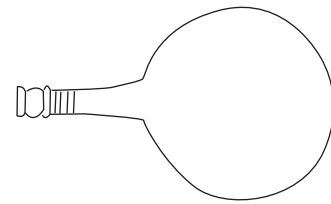

n°5 : 1994-L28-US 22-n°1  
d'après V.Merle

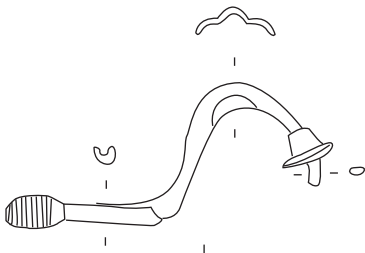

n°3 : 1999-N34-US 174-n°7

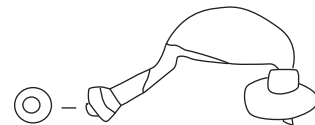

d'après V. Ganard

n°6 : N 39

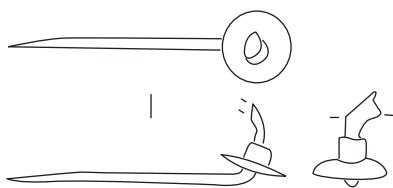

d'après V.Merle

n°7 : 1993-K23-US 23



n°8 : BB18-US 224-n°3

n°1 à 8 : bronze sauf n°4 : fer



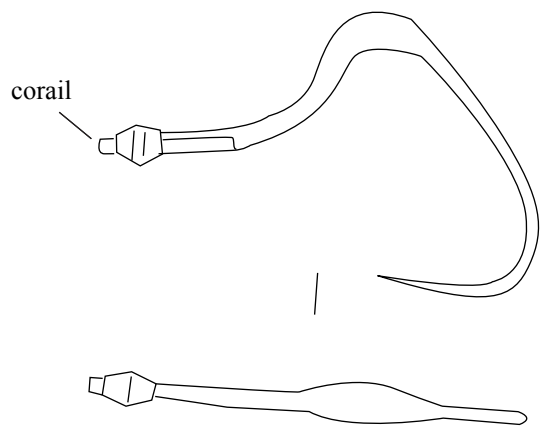

d'après V.Ganard

n°1 : 1997-AK22-US 84c-n°51

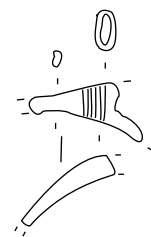

n°2 : 1997-AX25-US 119-n°35

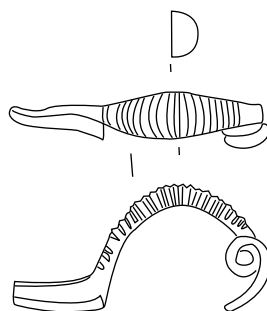

d'après V.Merle

n°3 : 1992-W14-US 12



d'après V.Merle

n°4 : 1996-K35-US 52-n°1

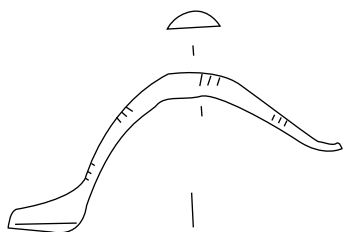

d'après V.Ganard

n°5 : 1997-AW25-US 119-n°16

n°1 à 5 : bronze

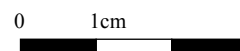



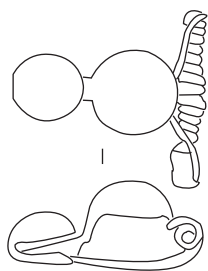

d'après V.Merle  
n°1 : 1993-Q24-US 11-n°11

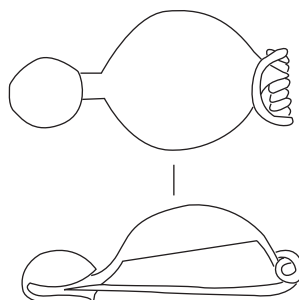

d'après V.Merle  
n°2 : 1994-H27-US 23-n°5

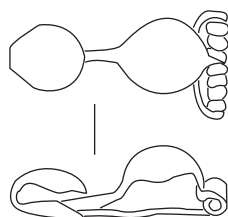

d'après V.Merle  
n°3 : 1992-W24 -US 11

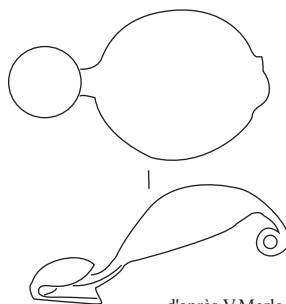

d'après V.Merle  
n°4 : 1995-K42-US 53-n°1

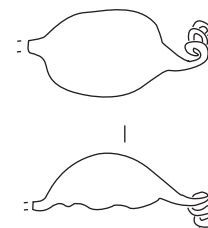

d'après V.Merle  
n°5 : 1995-M38-US 53-n°1

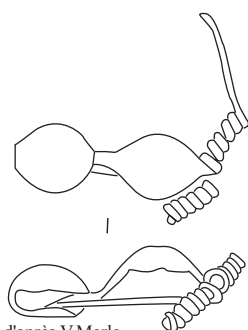

d'après V.Merle  
n°6 : 1993-O44-US 13-n°28

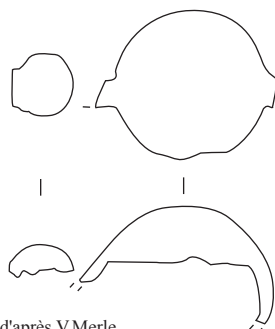

d'après V.Merle  
n°7 : 1994-H28-US 23-n°1-2

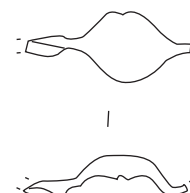

d'après V.Merle  
n°8 : 1996-AO22-US 02-n°3



d'après V. Ganard  
n°9 : 1997-AK21-US 81-n°6

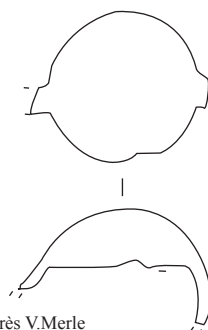

d'après V.Merle  
n°10 : 1994-H28-US 23-n°1

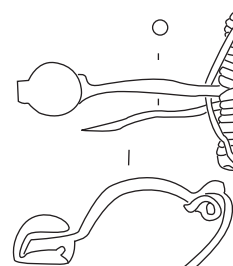

d'après V.Merle  
n°11 : AL22-US 84-n°13

n°1 à 11 : bronze



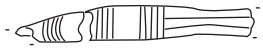

d'après V.Merle  
n°1 : 1993-01

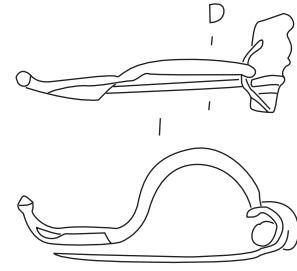
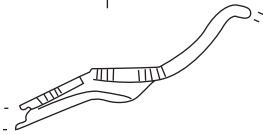

d'après V.Merle  
n°2 : 1996-AO24-US 84-n°22

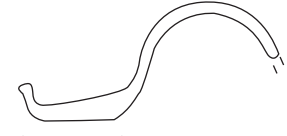
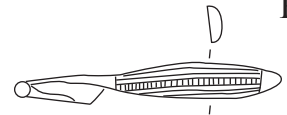

d'après V.Merle  
n°3 : 1994-K29-US 23-n°2

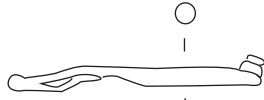

d'après V.Merle  
n°4 : 1993-Q24-US 12-n°18

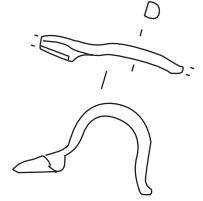

d'après V.Merle  
n°5 : 1996-AF21-US 00

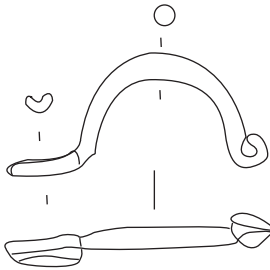

n°6 : 1999-S33-US 174-n°14

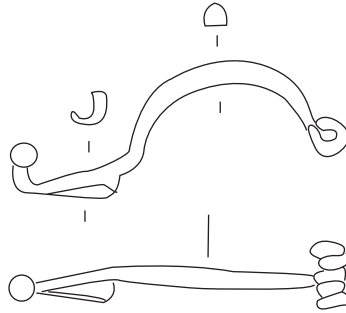

n°7 : 1999-Q36-US 53b-n°109

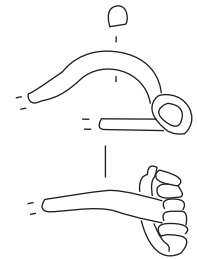

n°8 : 2001-AQ25-US 119-n°7

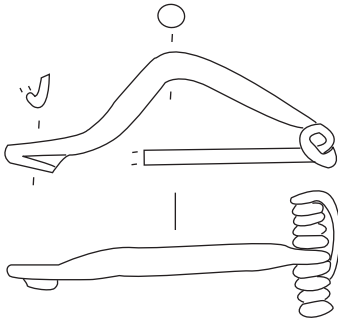

n°9 : 1999-Q36-US 53b-n°9

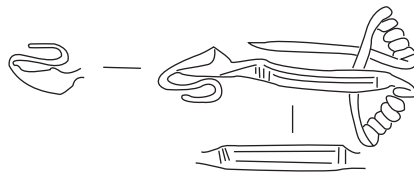

n°10 : 1998-BG18-US 168-n°1

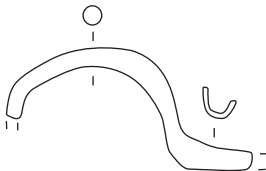

n°11 : N35-US 174-n°13

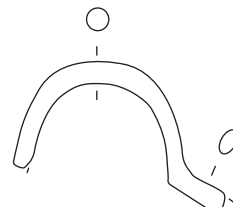

n°12 : 1992-K12-US 16-n°4

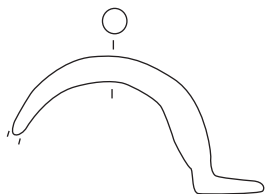

n°13 : 1994-G24-US 31

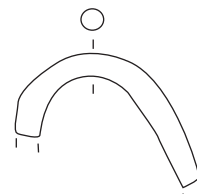

n°14 : 1998-S33-US 53b-n°9

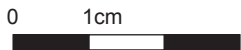

n°1 à 7-10 : bronze ; n°8-9-11 à 14 : fer

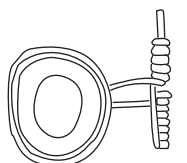

d'après V.Merle

n°1 : MAN 6392

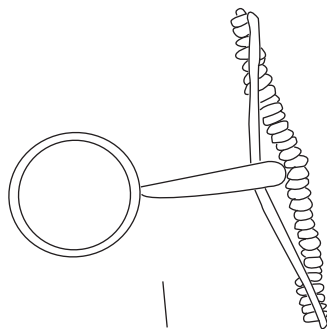

D

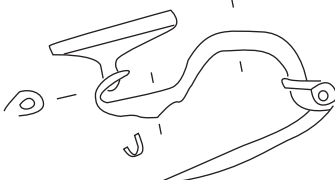

n°6 : Sans numéro



d'après V.Merle

n°8 : AO24-US 82-n°3

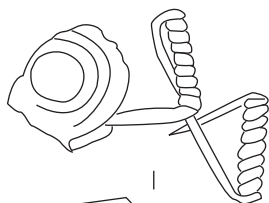

d'après V.Merle

n°2 : 1996-AL22-US 01-n°1

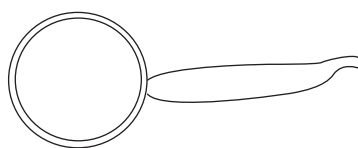

D

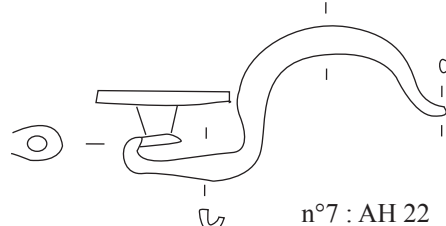

n°7 : AH 22

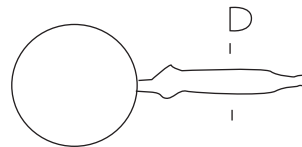

D

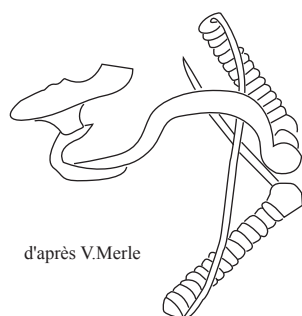

d'après V.Merle

n°9 : 1993-I22-US 2013-n°38

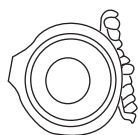

d'après V.Merle

n°3 : 1996-AN26-US 82-n°9



d'après V.Merle

n°4 : MAN 6394-01

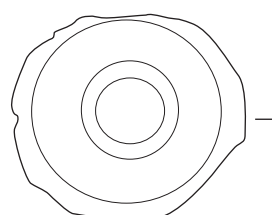

n°11 : 2001-AR23-US 107-n°1

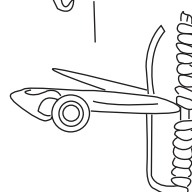

n°10 : 2001-AS23-US 107-n°1

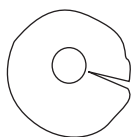

d'après V.Merle

n°5 : 1993-K13-US 14-n°40

n°1 à 5-8-10-11 : bronze ; n°7 : fer ; n°6-9 : bronze et fer

0 1cm



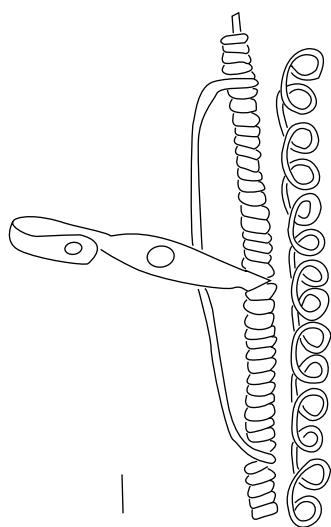

d'après V.Merle

n°1 : MAN 6988

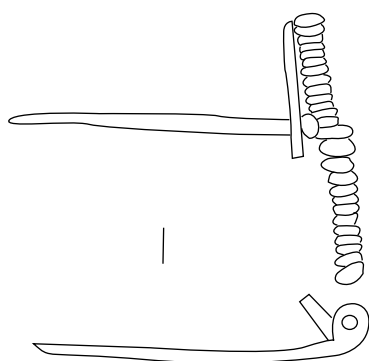

n°4 : AK25-US 84-n°15

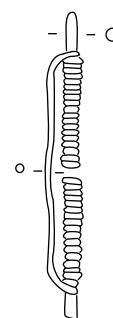

n°2 : 2001-AP23-US 108-n°3

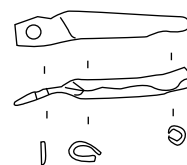

n°3 : 2001-AQ24-US 139-n°8



n°5 : 1996-AN21-US 93-n°11



n°6 : 1993-M22-US 12

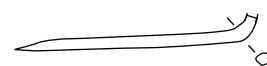

n°7 : 1999-P33-US 174-n°32



n°8 : 1998-R37-US 53-n°2

n°1 à 8 : bronze

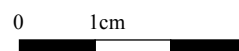

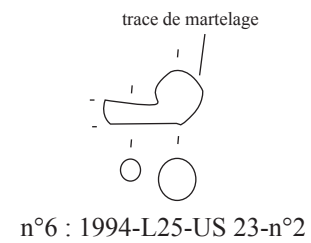
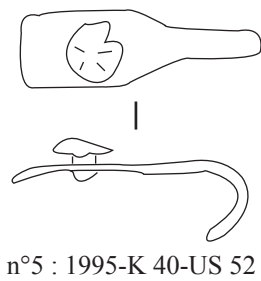
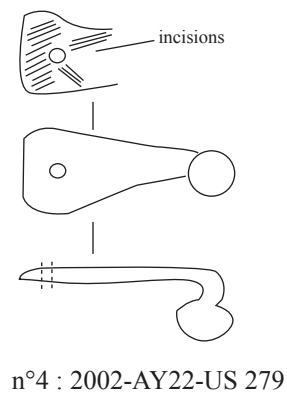
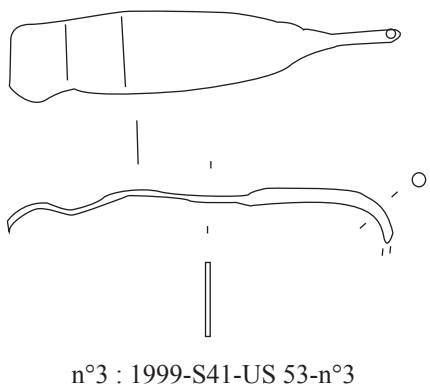
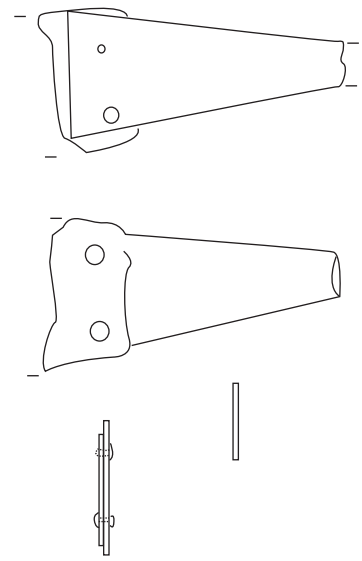
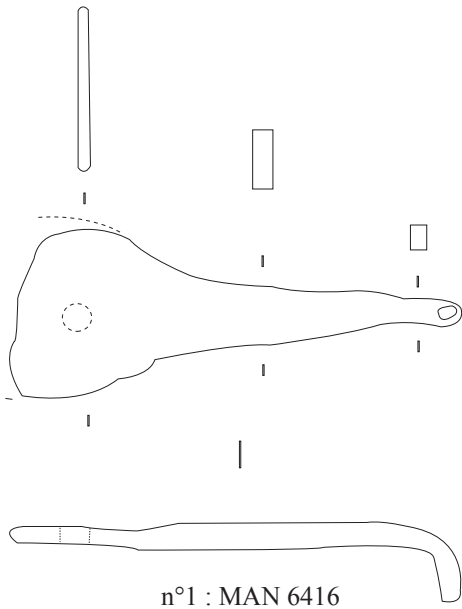

n°1-5 : fer sinon bronze

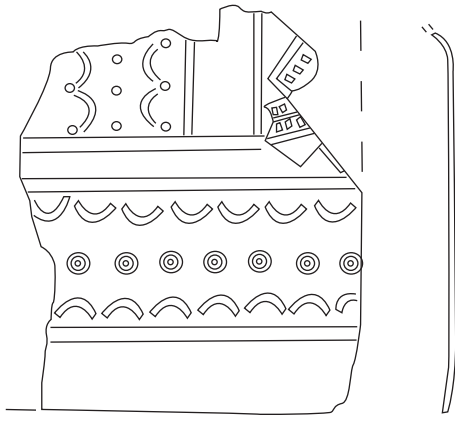

n°1 : 1993-M24-US 24-n°13

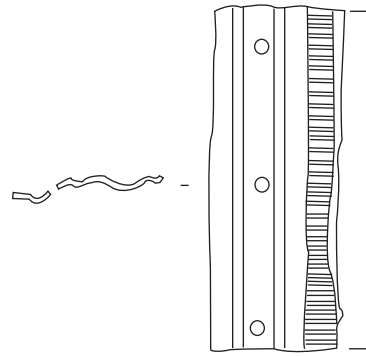

n°2 : 1993-K23-US 23-n°1

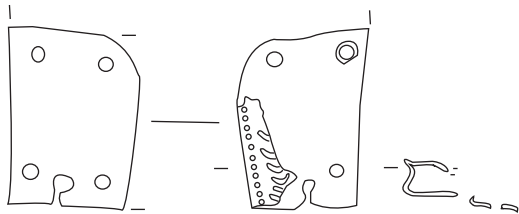

n°3 : 1999-Q36-US 53b-n°10

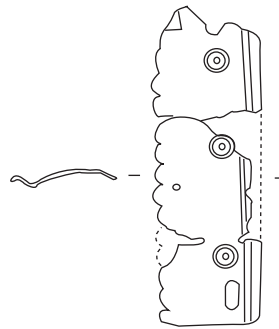

n°4 : 1992-W22-US 2007

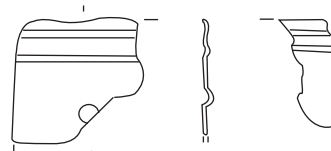

n°5 : 1994-J28 et J26-US 23-n°2

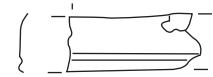

n°8 : 1994-K28-US 23-n°1

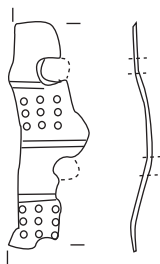

n°6 : 1994-L 25-US 23-n°3



n°7 : 1998-L34-US 53-n°4

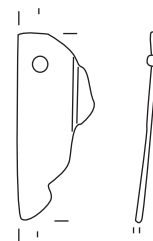

n°9 : 1999-I 40-US 189-n°18

n°1 à 9 : bronze

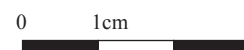

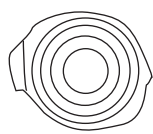

n°1 : 1995-J27-US 28-n°1

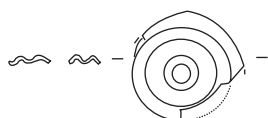

n°2 : 1998-AV23-US 162-n°1



n°3 : 1993-U26-US 14-n°24



n°6 : 1998-AW26-US 119-n°28

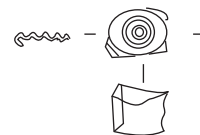

n°4 : 1992-U24-US 16



n°7 : 1993-Q22-US 13



n°5 : 1998-AW 26-US 139-n°45



n°8 : 1993-S22-US 12-n°71



n°9 : 1996-AO25-US 82-n°2



n°10 : 1999-R 32-US 174-n°1



n°11 : 1996-AJ22-US 96-n°8

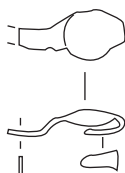

n°12 : 1996-M36-US 87-n°11

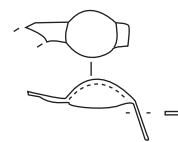

n°13 : 1993-Q22-US 13-n°74



n°14 : 1999-N33-US 174-n°19

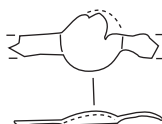

n°15 : 1994-M26-US 23-n°1



n°16 : 1996-L37-US 54-n°6

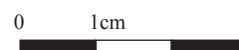

n°1 à 16 : bronze

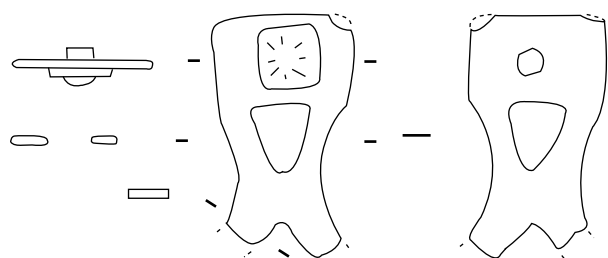

n°1 : 1998-R 33-US 53b-n°7

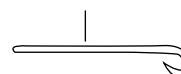
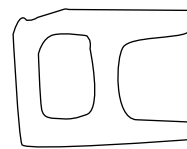
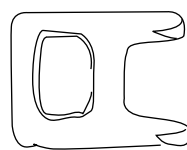

n°2 : 1995-L31-US 23-n°12



I



n°3 : MAN 6420

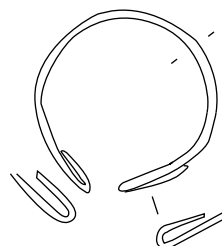

n°4 : 1996-AM21-US 82-n°5

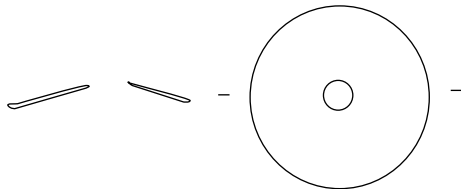

n°5 : 1994-O52-US 23-n°1

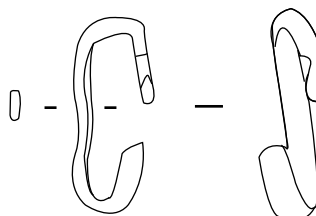

n°6 : 1992-Y22-US 2007

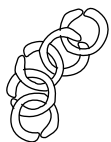

n°7 : 1996-M36-US 01-n°1



n°8 : 1993-J28-US 23



n°9 : 1998-P33-US 53b-n°6



n°10 : 1994-J28-US 23



n°11 : 1996-AL24



n°12 : 1993-H11-US 26



n°13 : 1993-N10



n°14 : 1999-N36-US 174-n°10

n°1-3-6 : fer sinon bronze

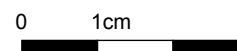



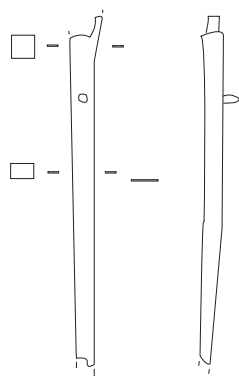

n°1 : 1993-W28-US 14-n°1

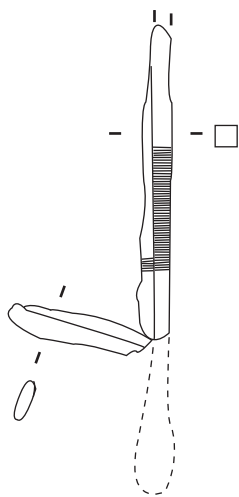

n°2 : 1992-O52-US 2006

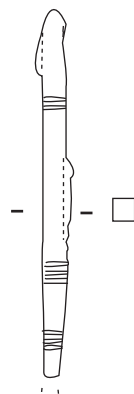

n°3 : 1999-Q 33-US 174-n°12

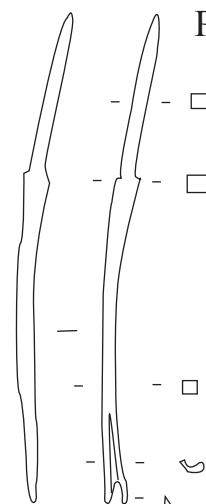

n°4 : 1994-L28-US 42-n°3

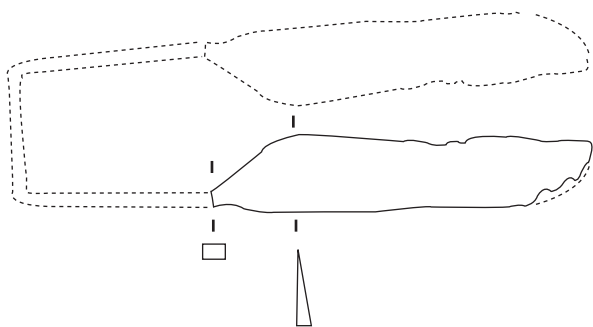

n°5 : 1994-K 25-US 23

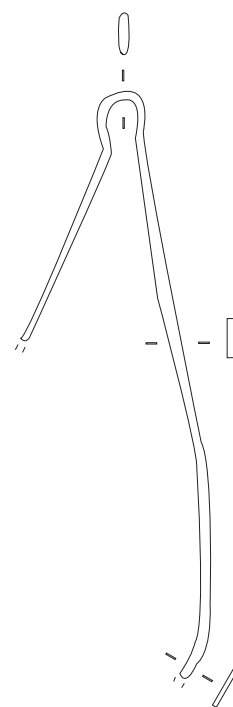

n°6 : 1992-O52-US 2006

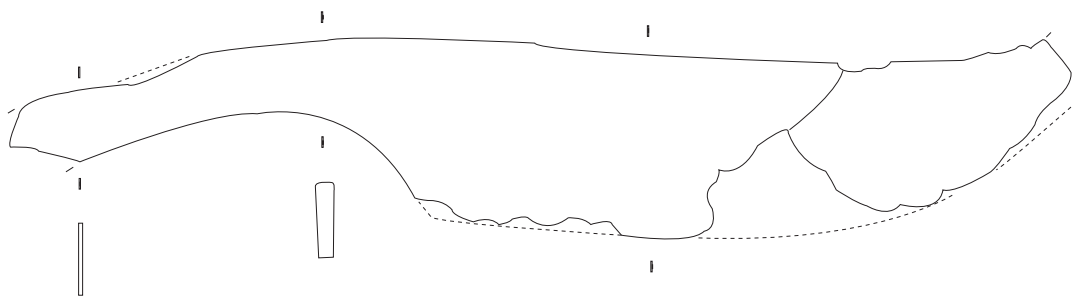

n°7 : 1989-secteur 2

n°1 à 7 : fer sauf n°4 : bronze



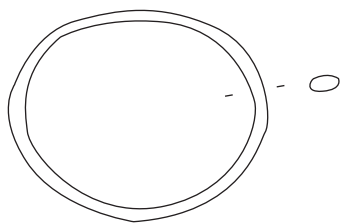

n°1 : 1999-O40-US 53-n°2



n°2 : 1998-L33-US 53-n°1



n°4 : 2001-X18-US 221



n°3 : 1992-W24-US 14

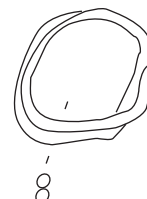

n°5 : 1997-AJ20-US 86-n°2

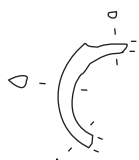

n°6 : 1993-J12-US 12-  
n°120

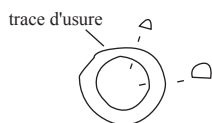

n°7 : 1999-Q41-US 53-n°3

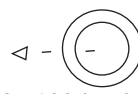

n°8 : 1996-M36-US 83-  
n°7



n°9 : 1997-AW24-US 108-  
n°5



n°10 : 1995-sans numéro



n°11 : 1999-R33-US 174-n°15

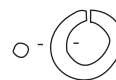

n°12 : 1999-O34-US 174-  
n°2



n°13 : 2001-tranchée 19eme



n°14 : 1997-AX25-US 119-  
n°10

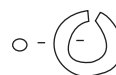

n°15 : 1998-P33-US 53b

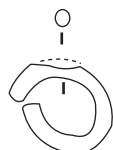

n°16 : 1993-O50-US 2013-n°53



n°17 : 1994-K30-US 23



n°18 : 1996-J36-US 54

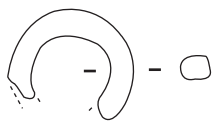

n°19 : 1994-H27-US 23

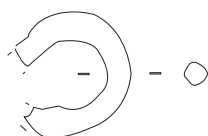

n°20 : 1993-U28-US 14-n°11

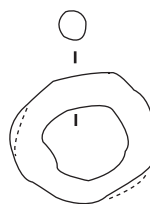

n°21 : 1994-J 25-US 22-n°1

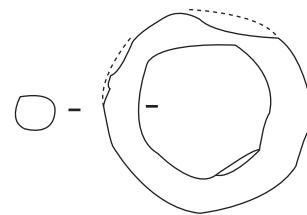

n°22 : 1996-AO 25-US 84-n 10

n°1 à 20 : bronze ; n°21-22 : fer

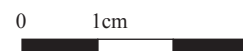

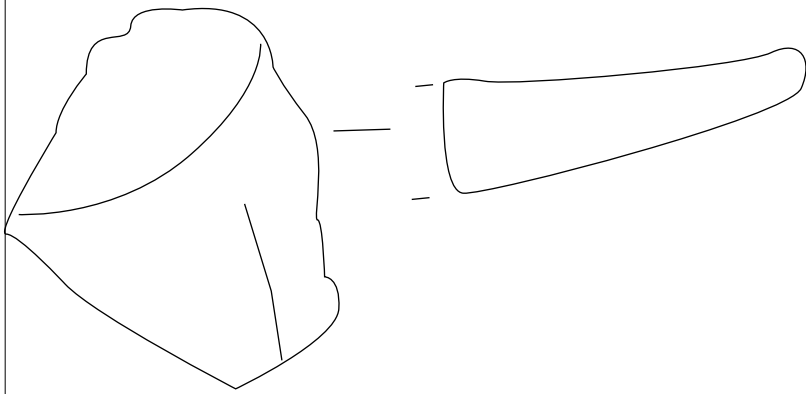

n°1 : 1999-n°19

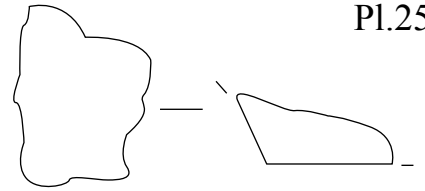

n°2 : 1996-AO26-US 84-n°9

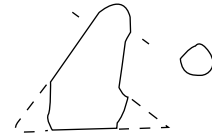

n°3 : 1998-AV26-US 139-n°21

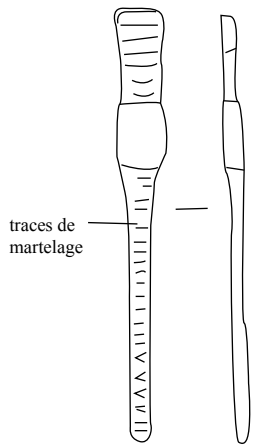

n°4 : 1996-AN24-US 84

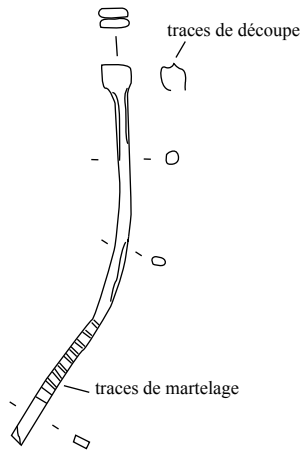

n°5 : 1993-H24-US 01-n°1

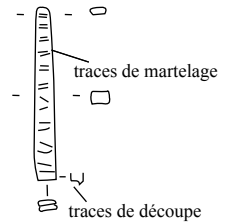

n°6 : 1996-AM24-US 101-n°20

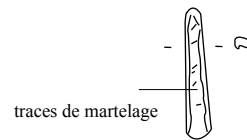

n°7 : sondage 8-US 105

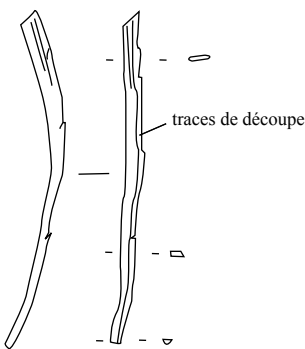

n°8 : 1996-AL 23-US 101-n°27

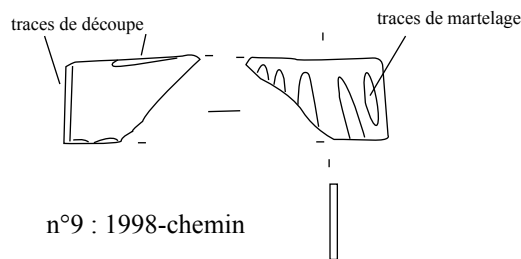

n°9 : 1998-chemin

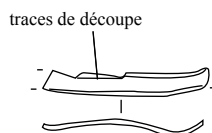

n°10 : 2001-AQ24-US 106

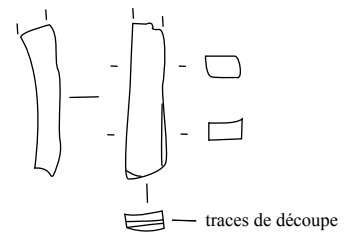

n°11 : 1995-N26-US 61-n°3

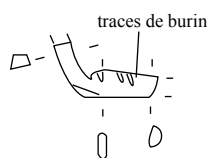

n°12 : 1996-AH20-US 01-n°2

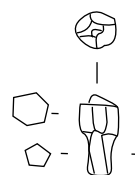

n°13 : 1999-S40-US 189-n°14

0 1cm

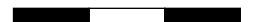

n°1 à 13 : bronze

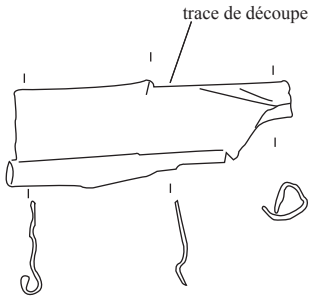

n°1 : 1996-AJ21-US 97-n°27

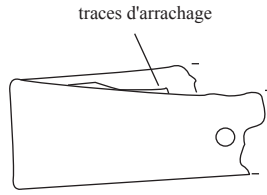

n°2 : 1992-U22-US 12

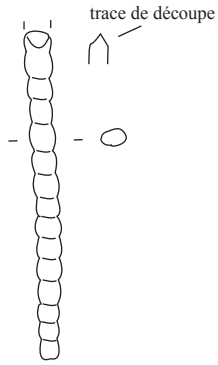
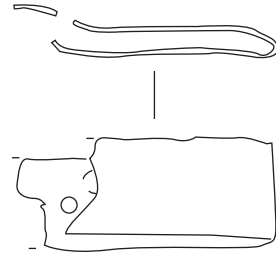

n°3 : 1996-AF21-US 00-anc. tranchée

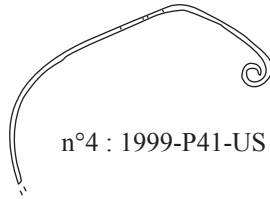

n°4 : 1999-P41-US 53b-n°5

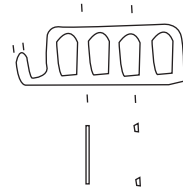

n°5 : 1994-F26-US 23

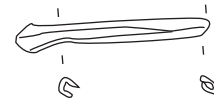

n°7 : 1994-N27-US 47

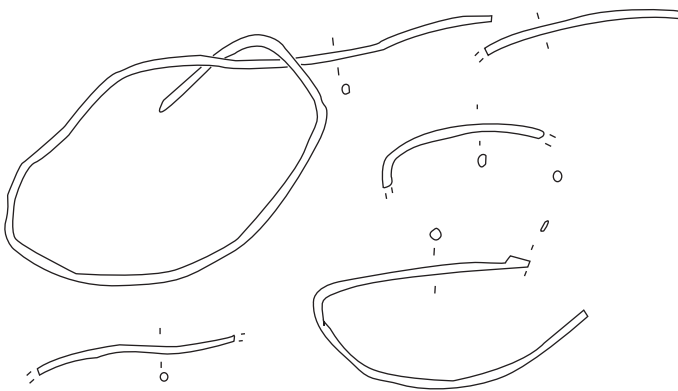

n°6 : 1999-H12-US 29

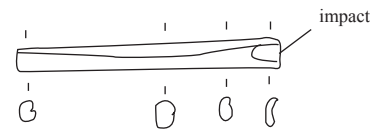

n°8 : 1994-J29-US 23

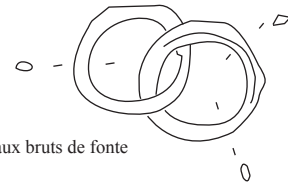

anneaux bruts de fonte

n°9 : 2001-AT25-US 119-n°8

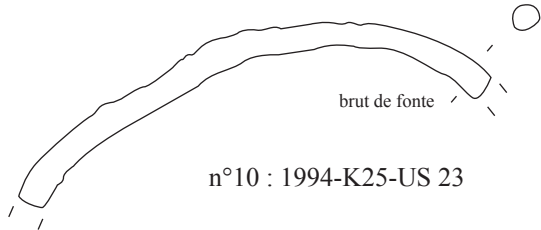

n°10 : 1994-K25-US 23



n°11 : 1994-M26-US 23-n°2

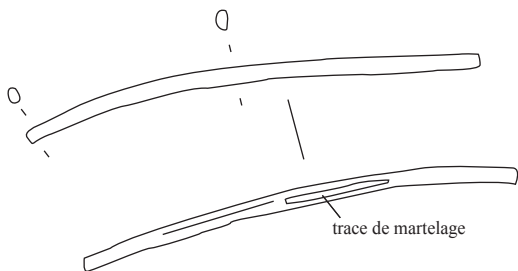

n°12 : 1998-R33-US 02-n°1

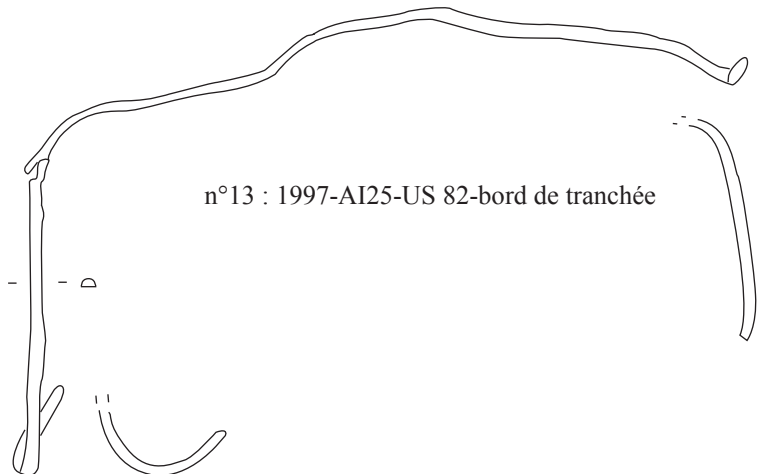

n°13 : 1997-AI25-US 82-bord de tranchée

n°1 à 13 : bronze

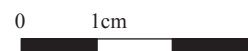

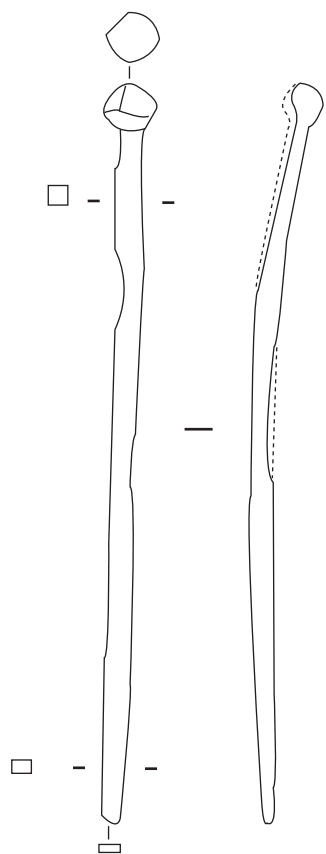

n°1 : 1997-AX 26-US 108-n°5

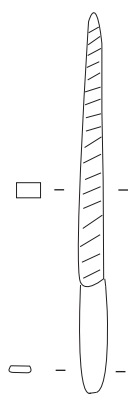

restes ligneux

n°2 : 1993-O22-US 12-n°27

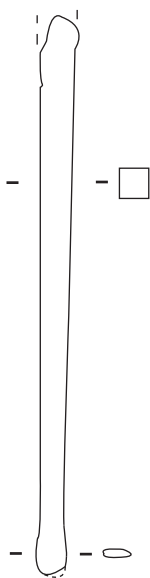

n°3 : 1994-N 26-US 22-n°2

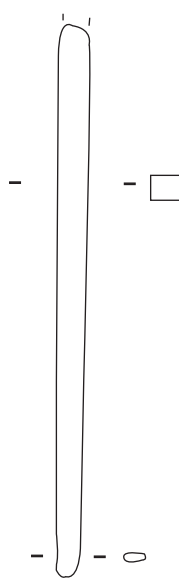

n°4 : 1997-AK 21-US 82-n°1

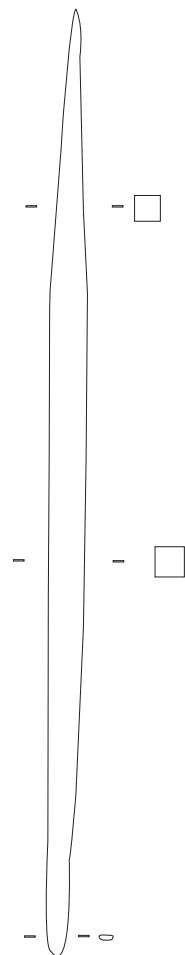

n°5 : 1995-K 39-US 53-n°1

n°1 à 5 : fer

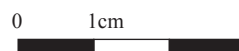

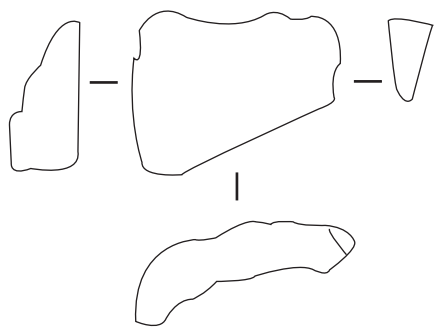

n°1 : 1993-U26-US 14-n°65

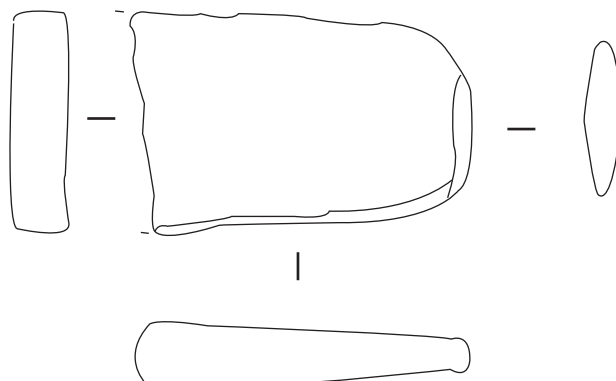

n°2 : 1995-secteur 1-M 38-US 53-n°2

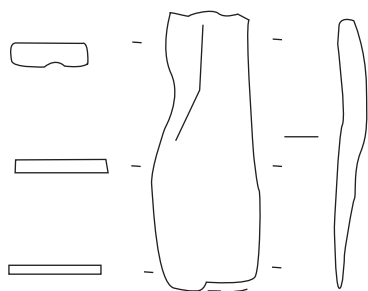

n°3 : 2002-AP27-US 106-n°1

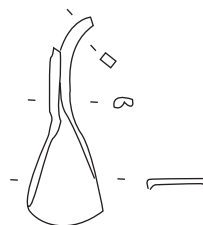

n°4 : 1993-M24-US 23

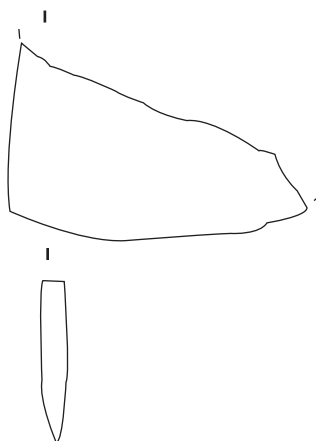

n°5 : 1999-L 39-US 53-n°6

n°1-2-5 : fer ; n°3-4 : bronze

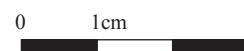

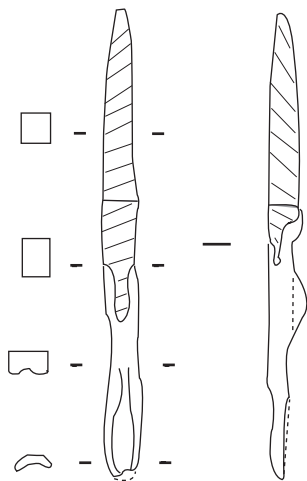

restes ligneux

n°1 : 1994-L 21-US 29-n°1

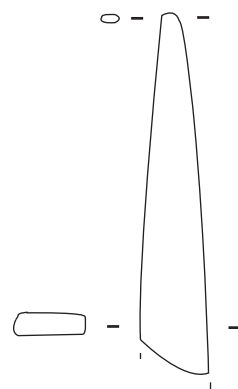

n°3 : 1996-AH 22-US 86-n° 4

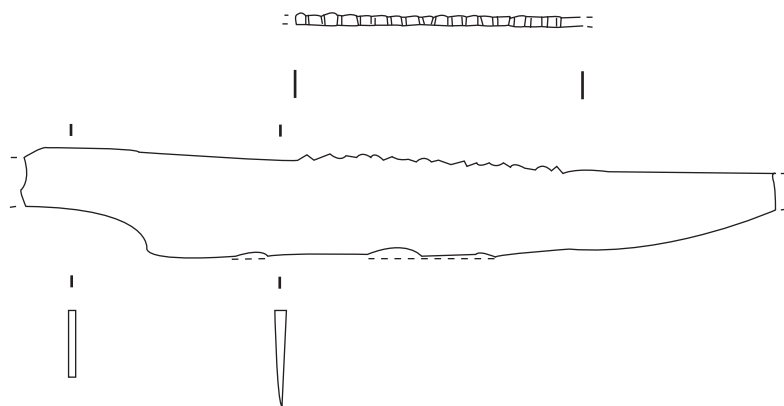

n°2 : 1992-US 2006

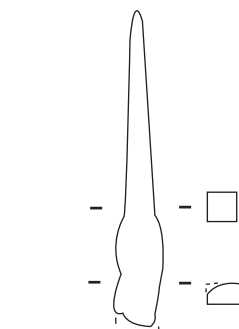

n°4 : 1993-O48-US 2013-n°31

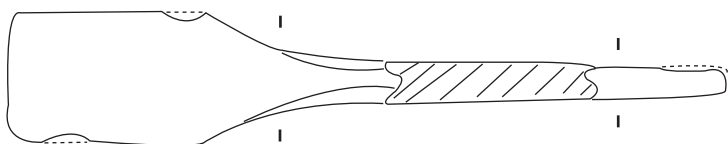
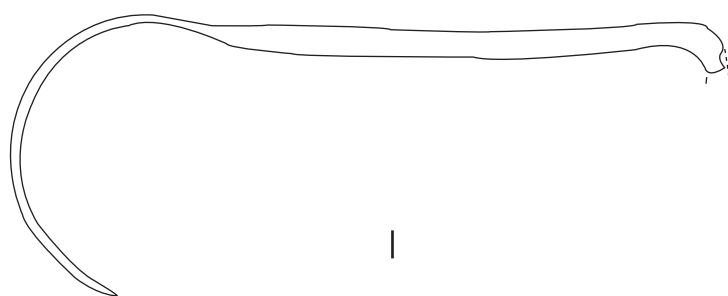

restes ligneux

n°5 : 1997-AK 24-US 84c-n°71

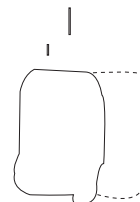
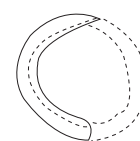

n°6 : 1993-Q20-US 12

n°1 à 6 : fer

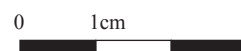

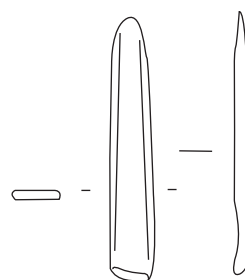

n°1 : 1997-sond.8-US 105

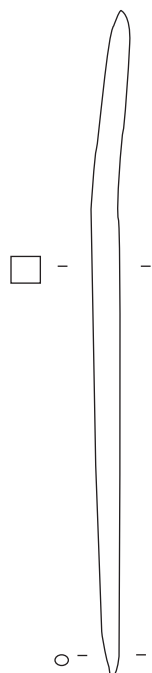

n°2 : 1996-AF21-US 01-  
ancienne tranchée

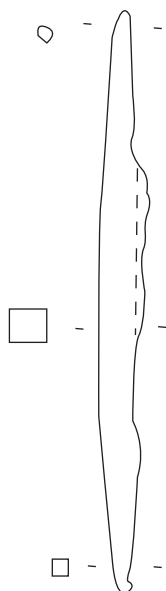

n°3 : 2002-AS24-US 139-n°20



n°4 : 1997-AY25-  
US 119-n°8



n°5 : 1996-M36-  
US 53-n°3

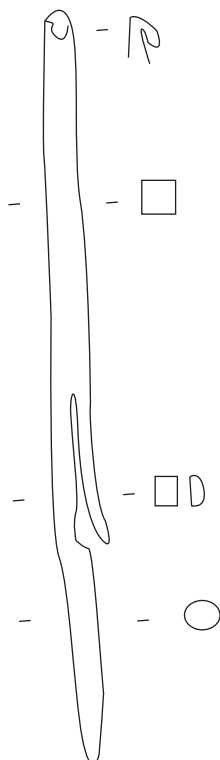

n°6 : 2001-BA18-US (?) - n°1

n°3-6 : fer sinon bronze





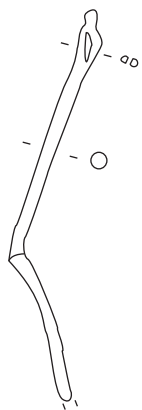

n°1 : 1999-P 39-US 186-  
n°15

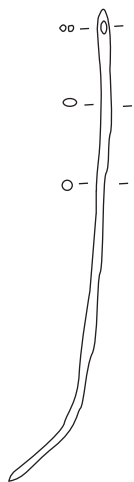

n°2 : Sans numéro



n°3 : Sans numéro

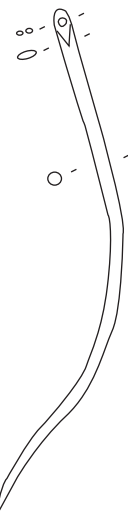

n°4 : Sans numéro

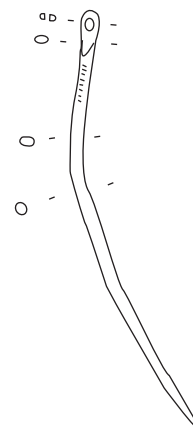

n°5 : Sans numéro

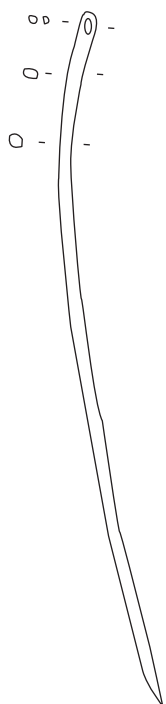

n°6 : Sans numéro



n°7 : 2001-X18-US 239-n°1

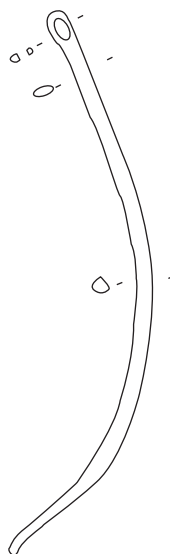

n°8 : 1999-R33-US 174-n°23

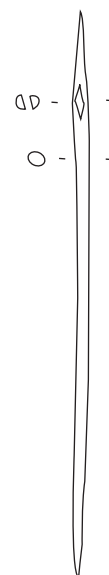

n°9 : 2002-AP23-US 282-  
n°27

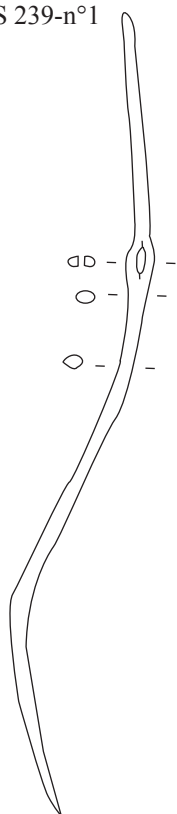

n°10 : Sans numéro

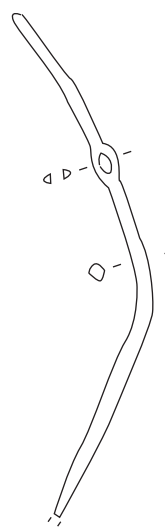

n°11 : Sans numéro

n°1 à 31 : bronze

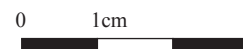

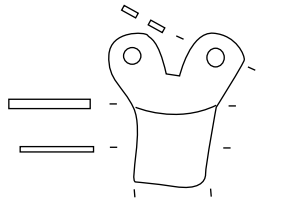

n°1 : 1994-K26-US 22-n°2

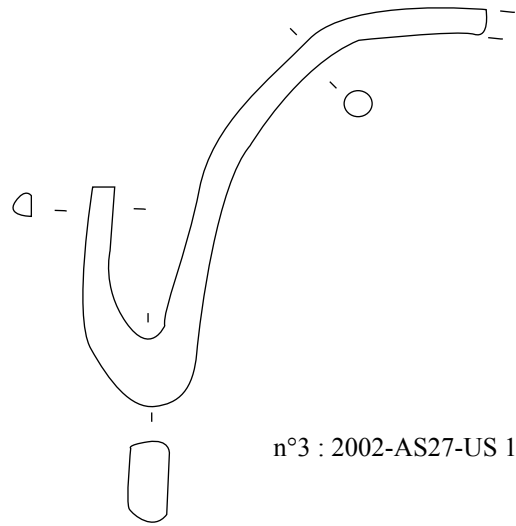

n°3 : 2002-AS27-US 106-n°1

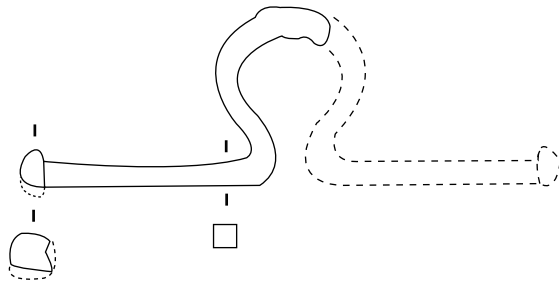

n°2 : 1994-P 24-US 33-n°2

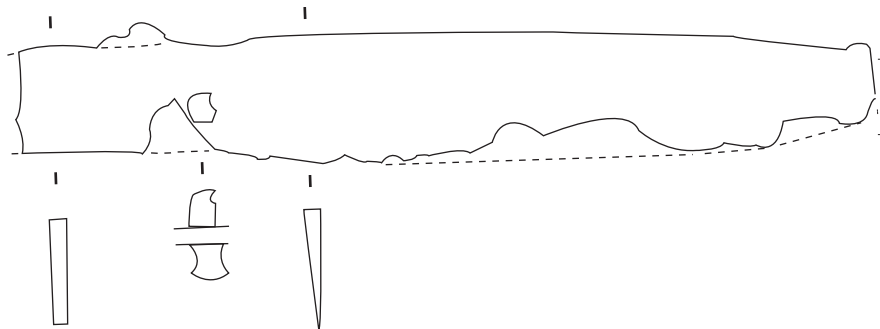

n°4 : 1999-Q 34-US 53b-n°9

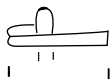

■ matière organique

n°5 : 1994-US 23-n°4

n°2 à 5 : fer ; n°1 : bronze

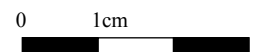

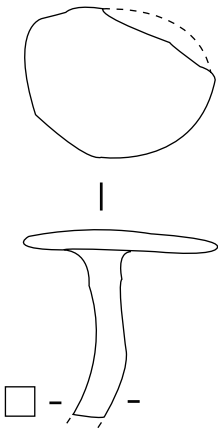

n°1 : 1999-O 40-US 53-n°1

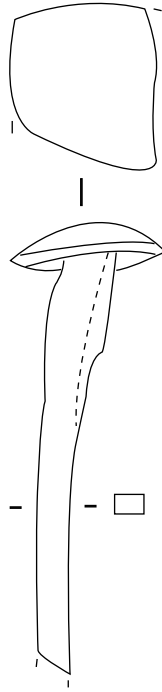

n°3 : 1992-O48-US 2007

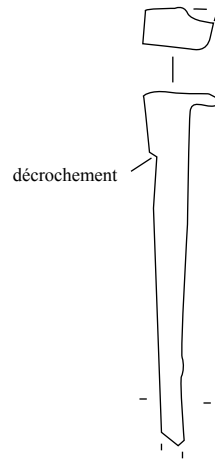

n°4 : 2002-AU27-US 107

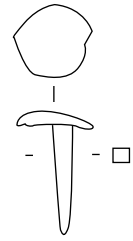

n°5 : 2001-tranchée-AR 22/23

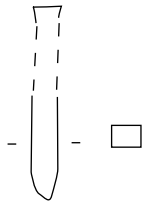

n°2 : 2001-rempart sud entrée-BB20-US 248-n°2

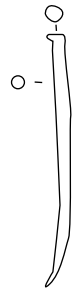

n°6 : 2001-AO23-hors stratigraphie-coupe



n°7 : 2001-AP25-US 107-n°1



n°8 : 1993-U28-US 14-n°17

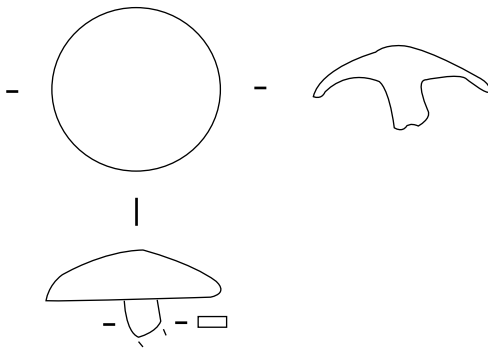

n°11 : 1997-R 37-US 53b-n 7

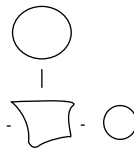

n°12 : 1996-AL24-US 84

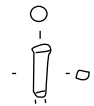

n°9 : 1997-BA25-US 119-n°9

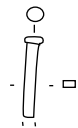

n°10 : 1997-AZ26-US 108-n°10

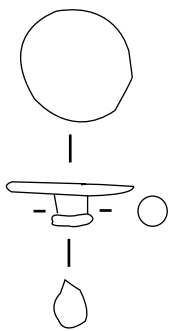

n°13 : 1999-R 41-US 53-n°2

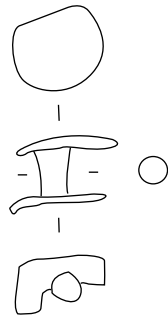

n°14 : AP22-US 108

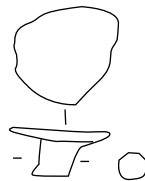

n°15 : 1998-Q34-US 53b-n°5

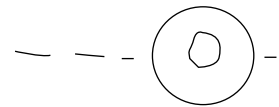

n°16 : 1993-K23-US 24-n°6



n°17 : 1994-K30-US 23

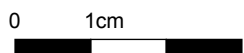

n°1 à 5-11-13-15 : fer sinon bronze

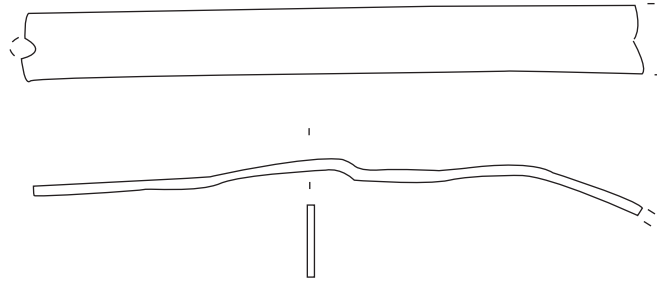

n°1 : 2002-AU24-US 139-n°19

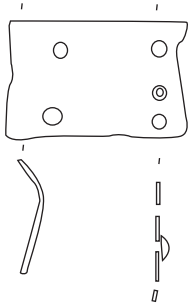

n°2 : 1996-M37-US 87-n°5

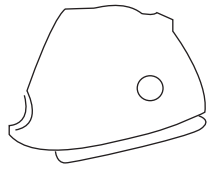

n°3 : 1994-K31-US 22

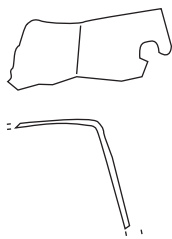

n°4 : 1993-O44-US 13

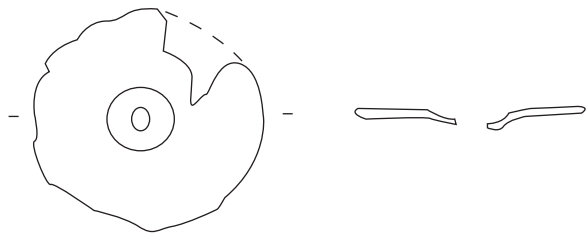

n°5 : 2001-AN26-US 105

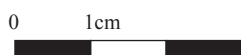

n°1-2 : fer ; n°3 à 5 : bronze

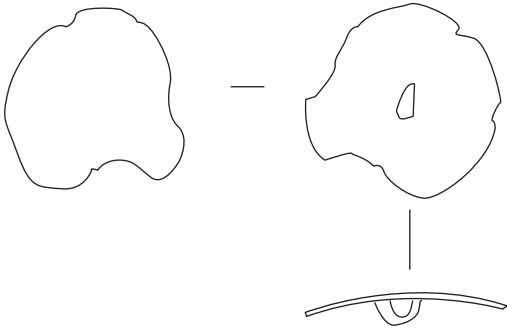

n°1 : 1996-AG22-US 96-n°15

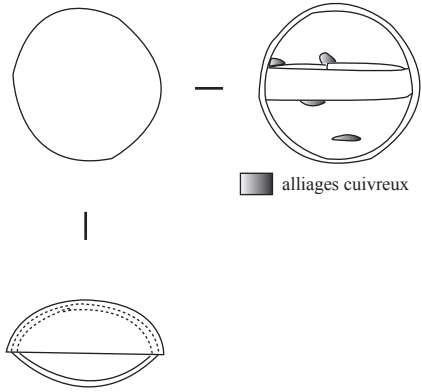

n°2 : 1994-I 28-US 23-n°2

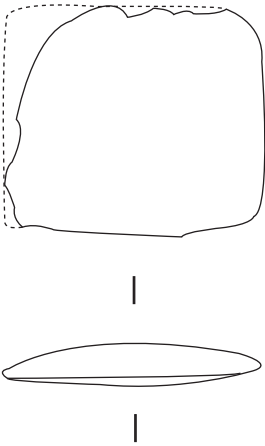

n°3 : 1993-AK 25-US 84-n°27

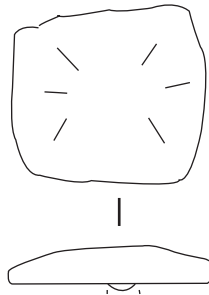

n°4 : 1995-J 39-US 53-n°1

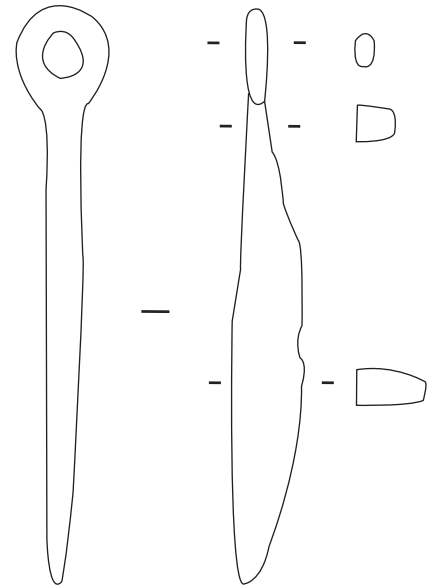

n°5 : 1998-P 34-US 53b-n°6

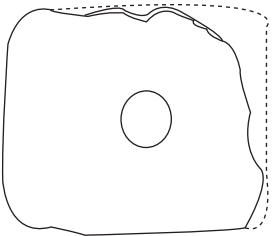

n°6 : 1999-R 40-US 53b-n°6

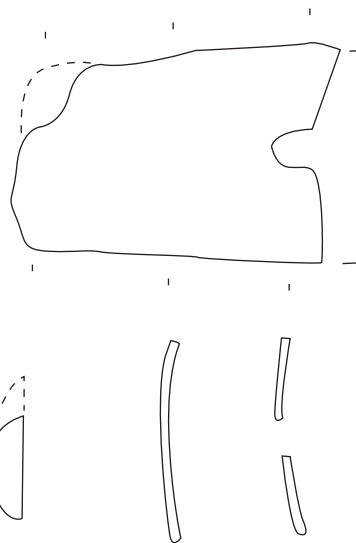

n°7 : 2001-rempart sud-entrée-  
BB19-US 124-n°1

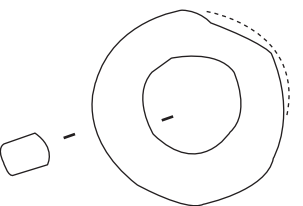
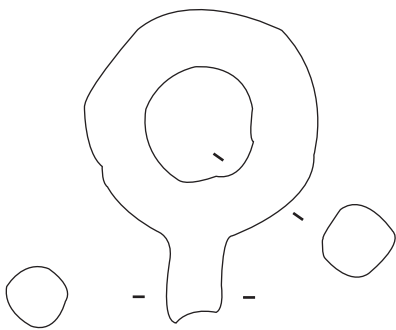

n°8 : 1998-R 39-US 53b-n°10

n°1 : bronze sinon fer





n°1 : 1993-M24-US 23-n 10

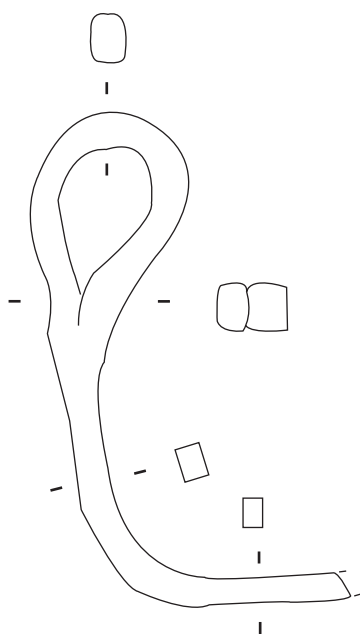

n°2 : 1993-U28-US 14-n°1

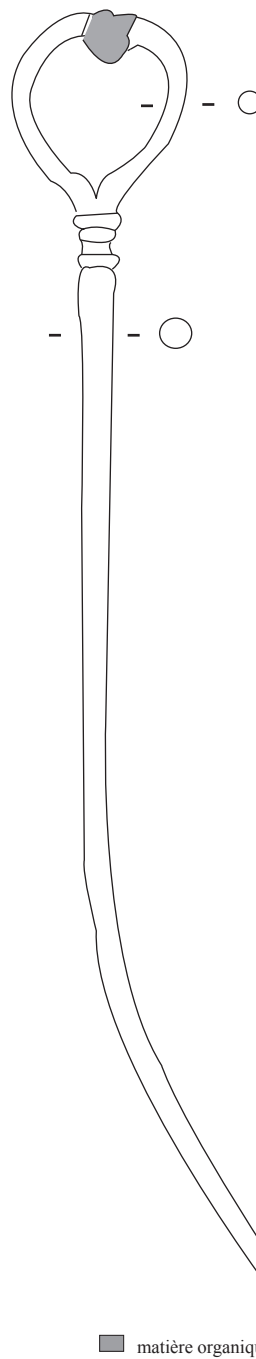

■ matière organique

n°3 : 1993-U26-US 14-n°5

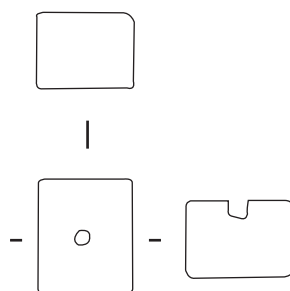

n°4 : 1999-Q 40-US 174-n 12

n°1 à 4 : fer

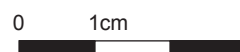

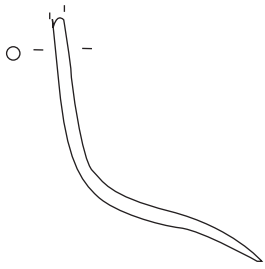

n°1 : 1995-M32-US 01

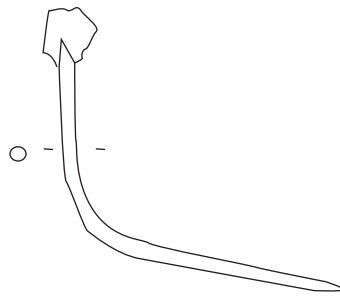

n°2 : 1997-BB26-US 119-n°11



n°3 : 1993-I 10-US 13-n°1

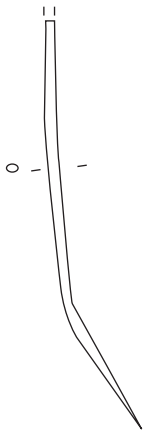

n°4 : 1996-AM 24-US 84-n°8

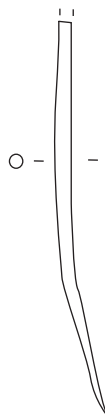

n°5 : 1993-S11-US 12-n°73

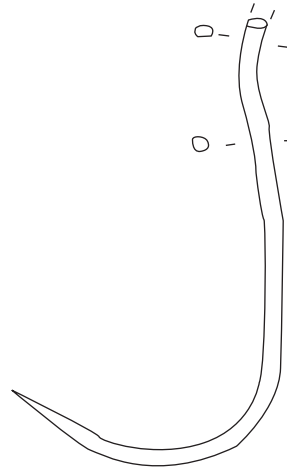

n°6 : 1998-T38-US 00-n°3

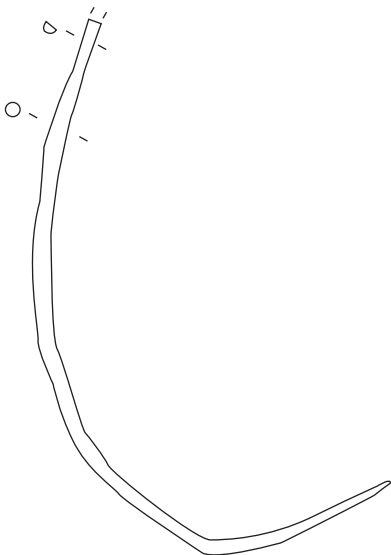

n°7 : 1994-M25-US 22 ou 02

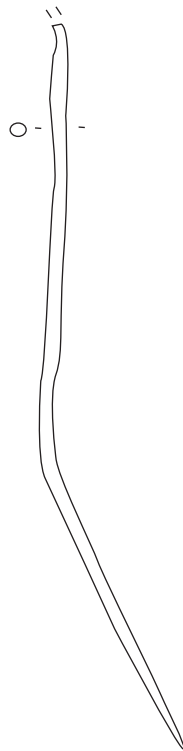

n°8 : 1992-K11-US 12

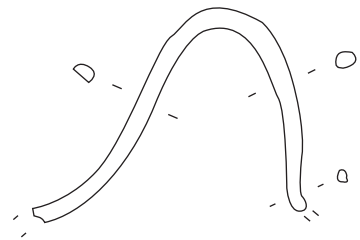

n°9 : 1993-O50-US 04-n°13

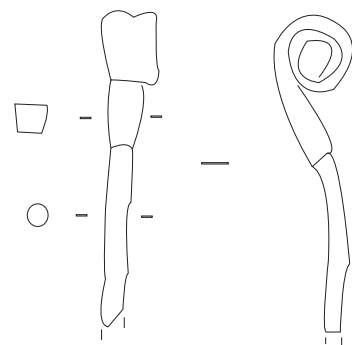

n°10 : 1996-AG 22-US 88-n°3



n°1 à 9 : bronze ; n°10 : fer

Hundersingen  
La Heuneburg



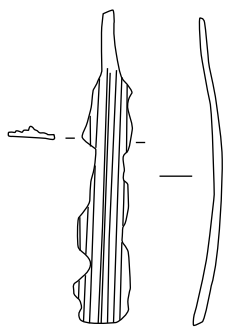

n°1 : D'après Sievers 1984, n°151

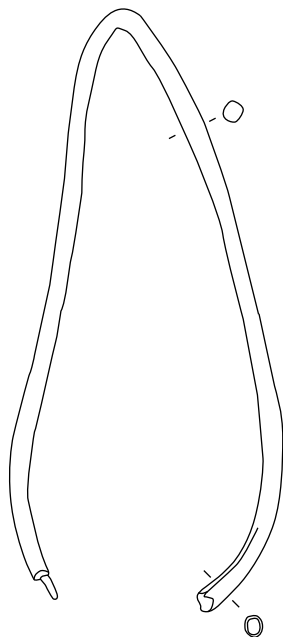

n°2 : D'après Sievers 1984, n°139

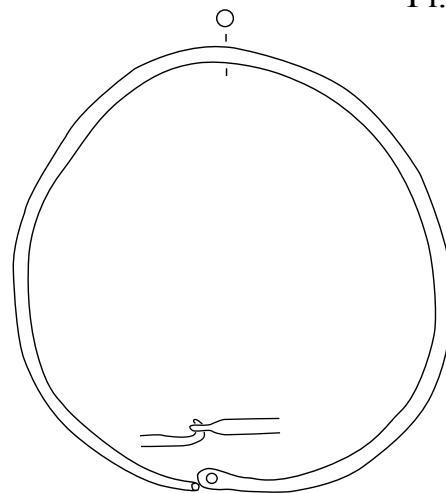

n°3 : D'après Sievers 1984, n°247

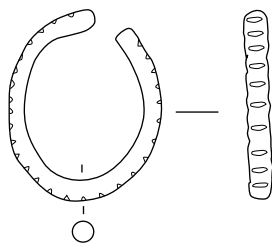

n°4 : D'après Sievers 1984, n°87

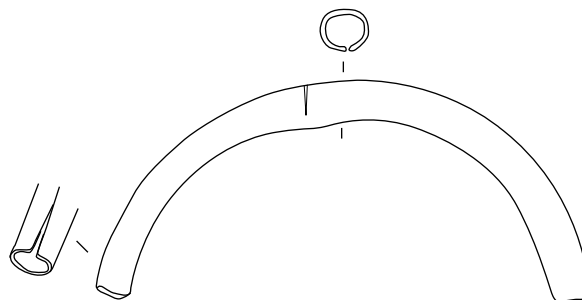

n°5 : D'après Sievers 1984, n°146

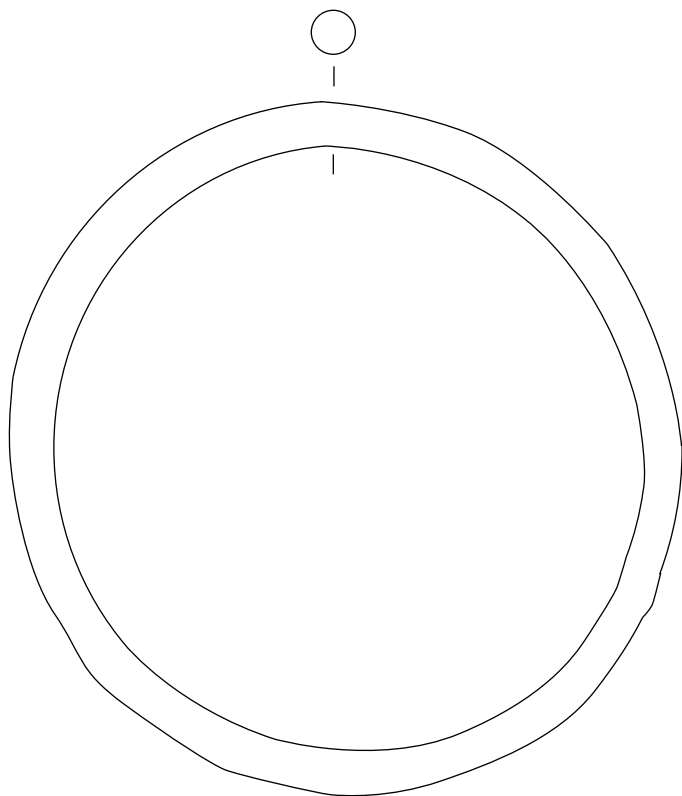

n°6 : D'après Sievers 1984, n°243

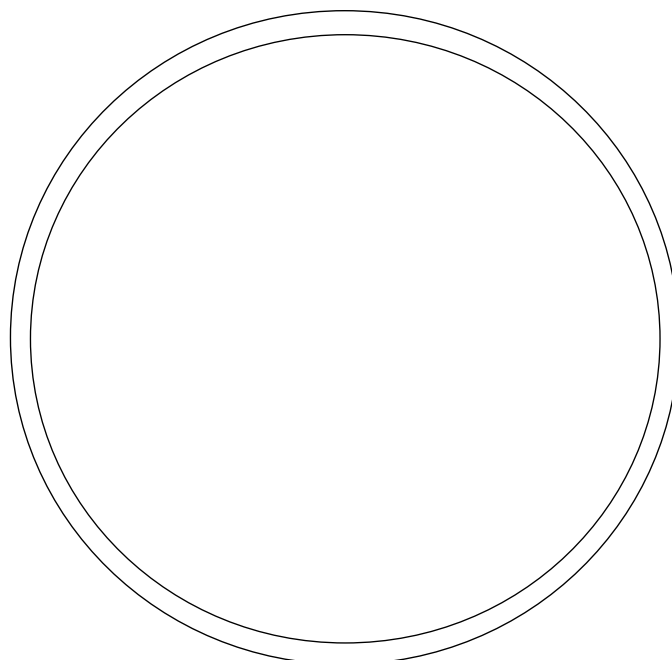

n°7 : D'après Sievers 1984, n°246

n°1 à 7 : bronze

0 1cm



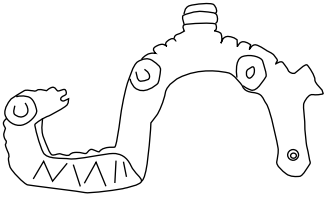
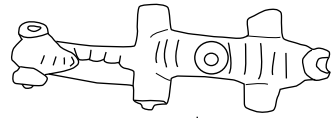

n°1 : D'après Sievers 1984, n°556

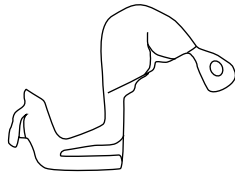
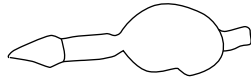

n°2 : D'après Sievers 1984, n°500

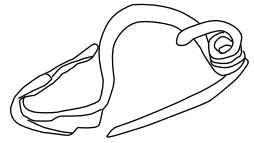
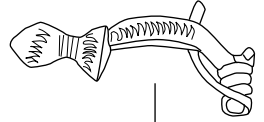

n°3 : D'après Sievers 1984, n°487

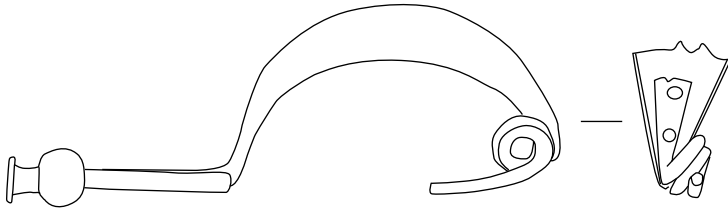
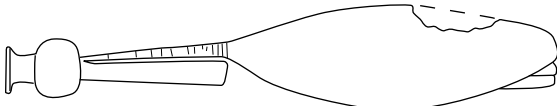

n°4 : D'après Sievers 1984, n°2342

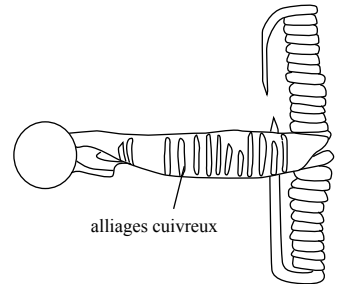

alliages cuivreux

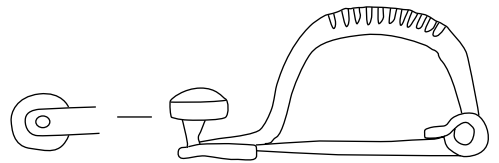

n°5 : D'après Sievers 1984, n°2280

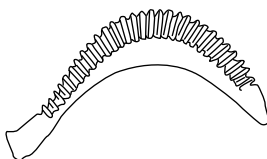
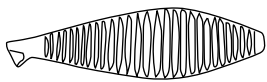

n°6 : D'après Sievers 1984, n°2188

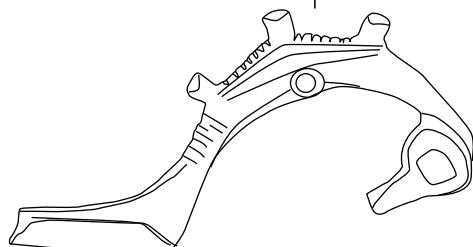
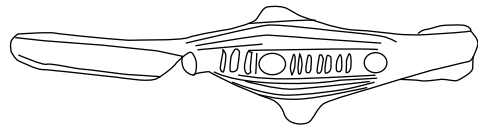

n°7 : D'après Sievers 1984, n°2189

n°1 à 7 : bronze sauf n°5 : fer

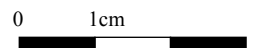

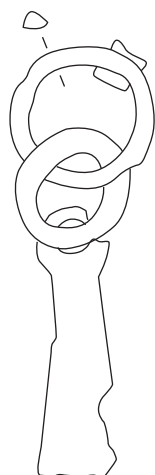

n°1 : D'après Sievers 1984,  
n°1106

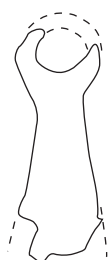

n°2 : D'après Sievers 1984,  
n°1107

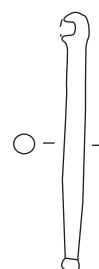

n°3 : D'après Sievers 1984,  
n°1121



n°4 : D'après Sievers 1984,  
n°1141



n°5 : D'après Sievers 1984,  
n°1123



n°6 : D'après Sievers 1984,  
n°1115



n°7 : D'après Sievers 1984,  
n°1118

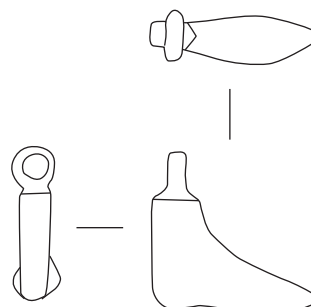

n°8 : D'après Sievers 1984,  
n°1128

n°1 à 3 : fer ; n°4 à 8 : bronze



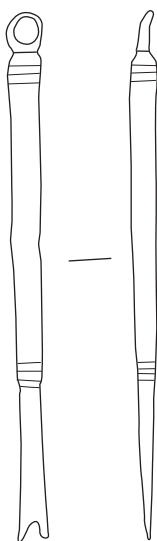

n°1 : D'après Sievers 1984,  
n°1473

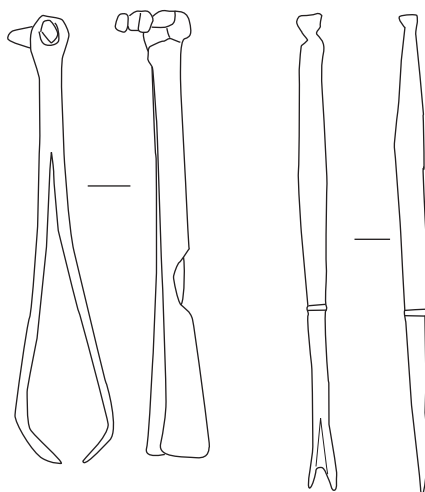

n°2 : D'après Sievers 1984,  
n°1474



n°3 : D'après Sievers 1984,  
n°1469

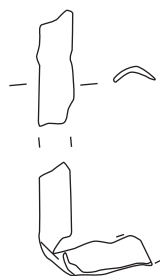

n°4 : D'après Sievers 1984, n°1400



n°5 : D'après Sievers 1984,  
n°1384

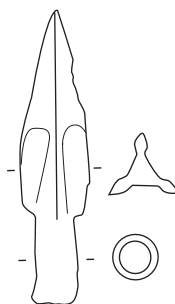

n°6 : D'après Sievers 1984,  
n°1464

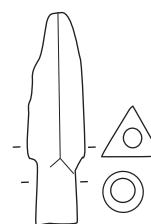

n°7 : D'après Sievers 1984,  
n°1466



n°1-2-3 à 7 : bronze ; n°3 : fer

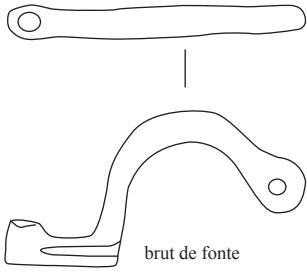

n°1 : D'après Sievers 1984, n°2281

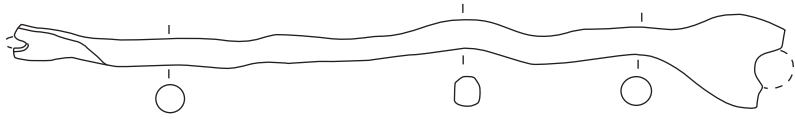

n°2 : D'après Sievers 1984, n°1159

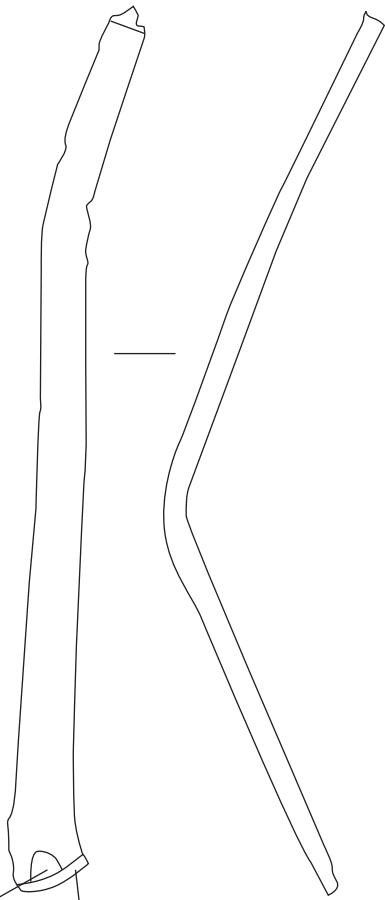

aplatissement  
trace de découpe

n°3 : D'après Sievers 1984, n°2108

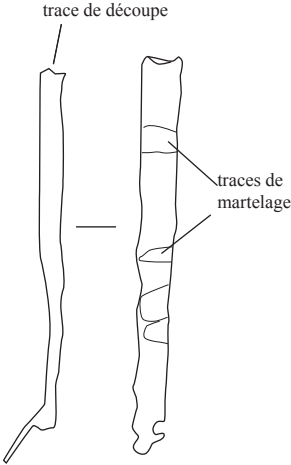

trace de découpe

traces de martelage

n°4 : D'après Sievers 1984, n°2109

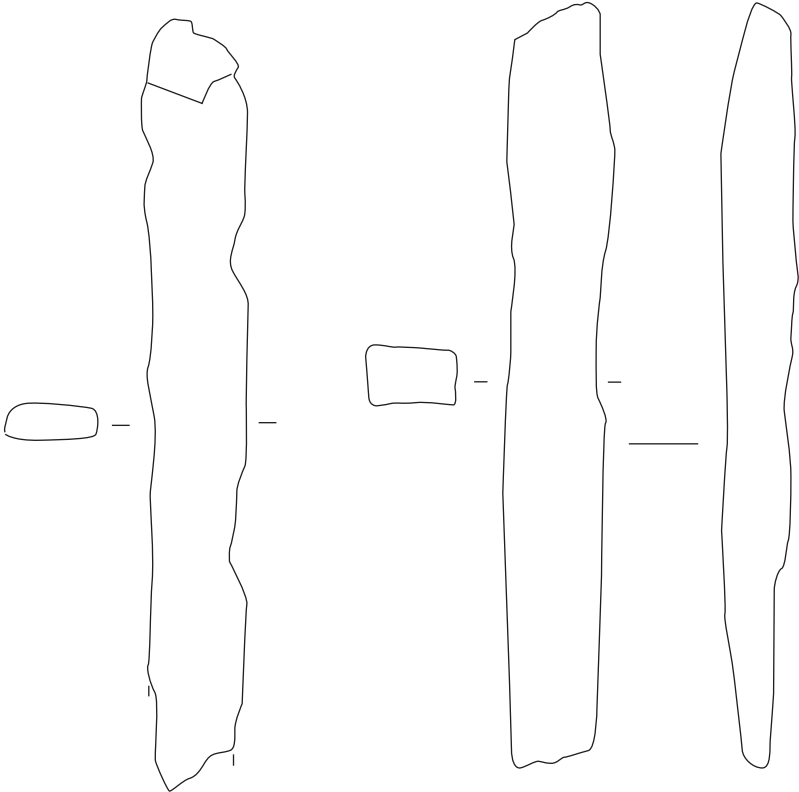

n°5 : D'après Sievers 1984, n°2113

n°6 : D'après Sievers 1984, n°2115

n°1-2 : bronze ; n°3 à 6 : fer

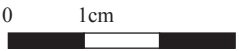

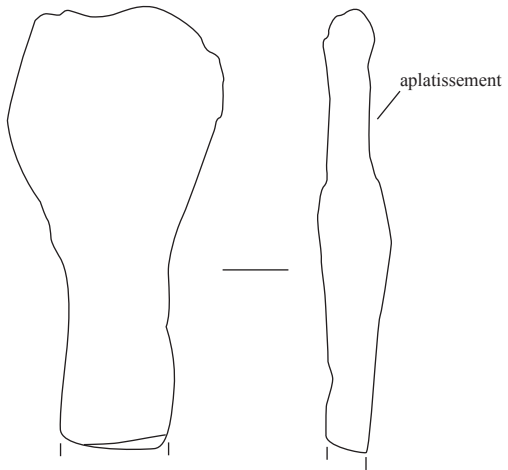

n°1 : D'après Sievers 1984, n°1999

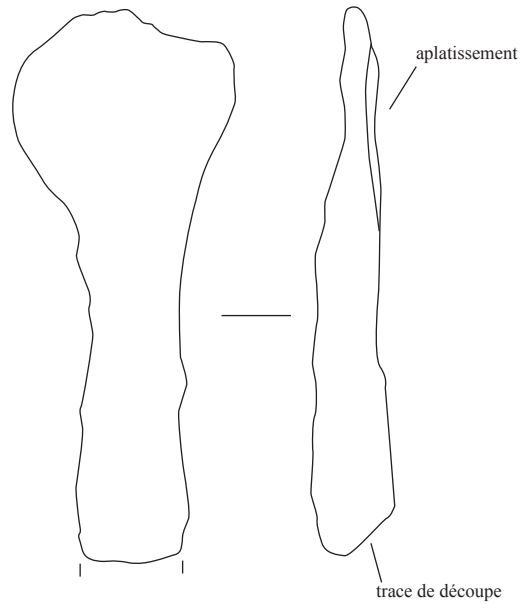

n°2 : D'après Sievers 1984, n°2001

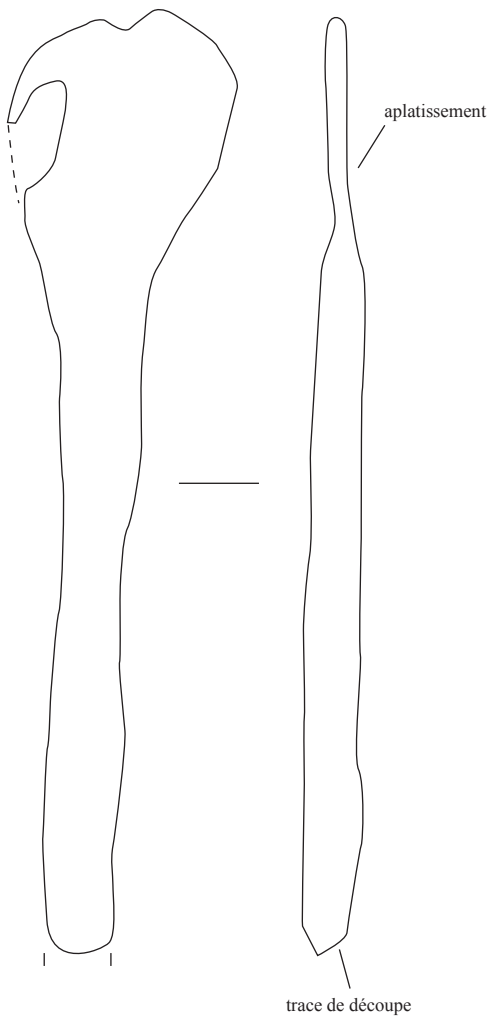

n°3 : D'après Sievers 1984, n°2000

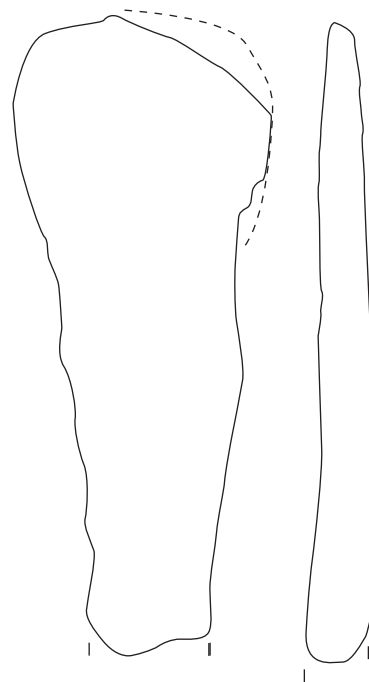

n°4 : D'après Sievers 1984, n°2002

n°1 à 4 : fer

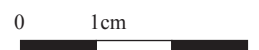

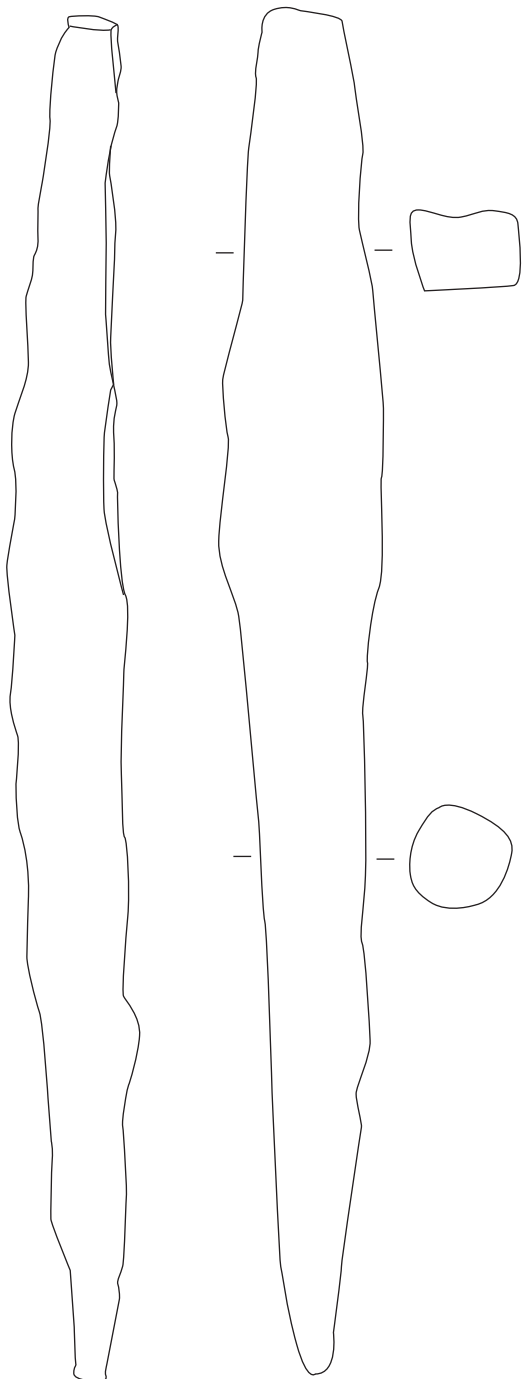

n°1 : D'après Sievers 1984, n°1839

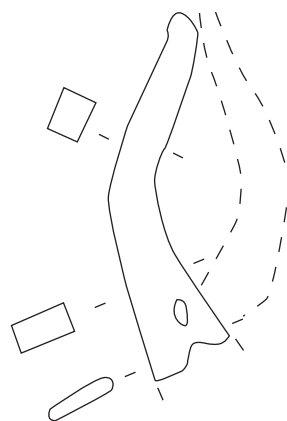

n°2 : D'après Sievers 1984, n°1842

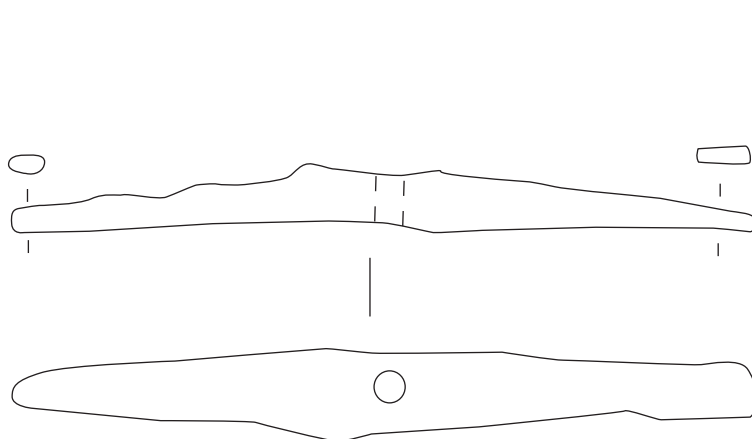

n°3 : D'après Sievers 1984, n°1840

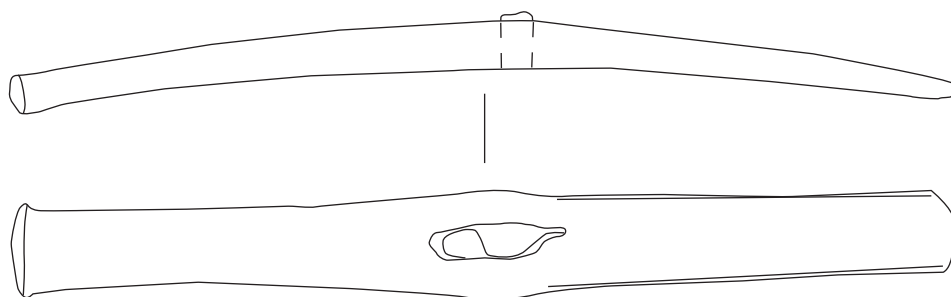

n°4 : D'après Sievers 1984, n°1841

n°1 à 4 : fer

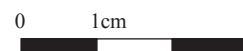

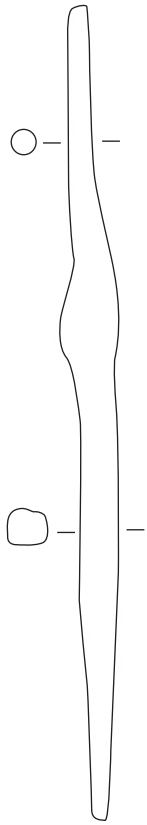

n°1 : D'après Sievers 1984, n°1873

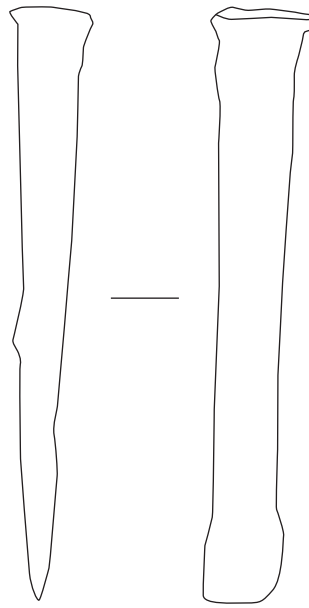

n°2 : D'après Sievers 1984, n°1849

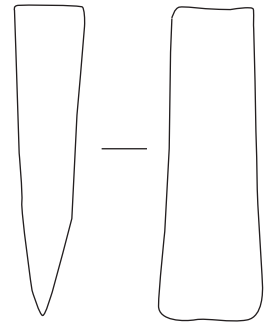

n°3 : D'après Sievers 1984, n°1851

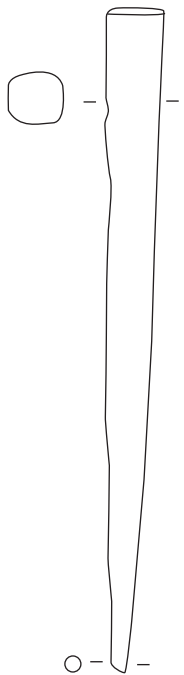

n°4 : D'après Sievers 1984, n°1854

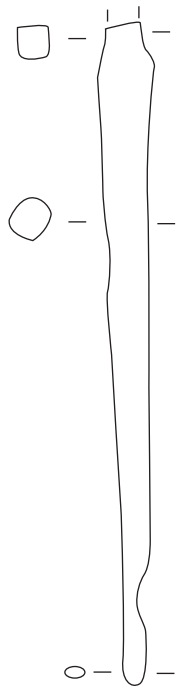

n°5 : Sievers 1984, n°1864

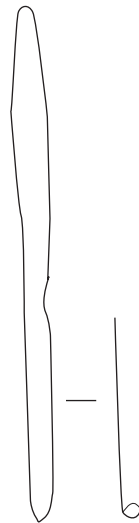

n°6 : Sievers 1984, n°1871

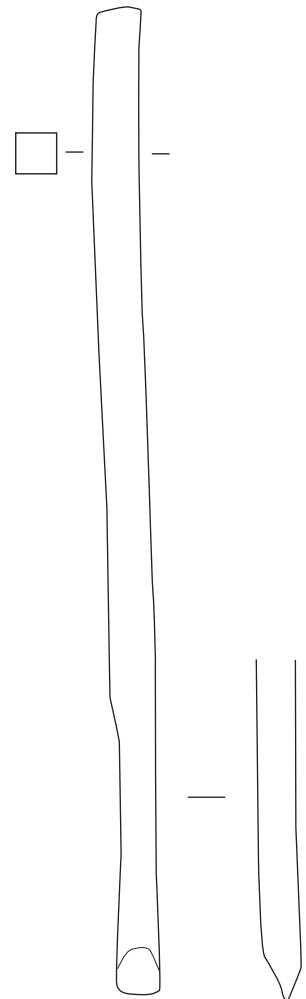

n°7 : Sievers 1984, n°1875

n°1 à 7 : fer

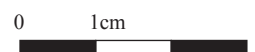



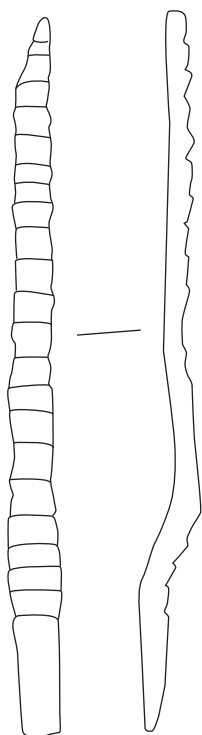

n°1 : D'après Sievers 1984, n°1843

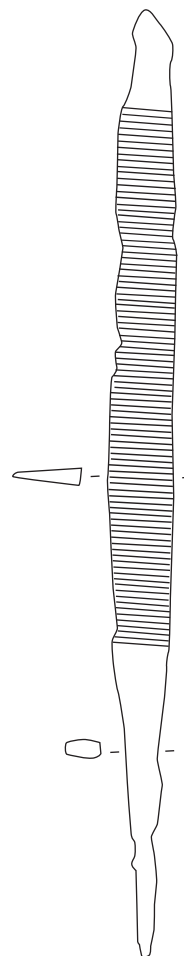

n°2 : D'après Sievers 1984, n°1845

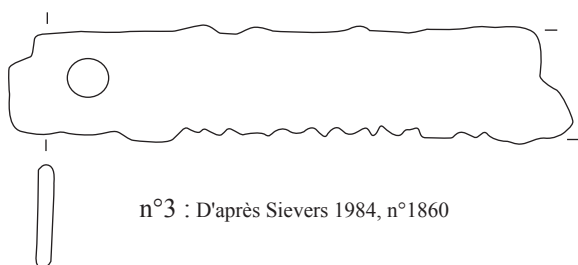

n°3 : D'après Sievers 1984, n°1860

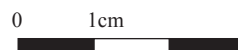

n°1 à 3 : fer

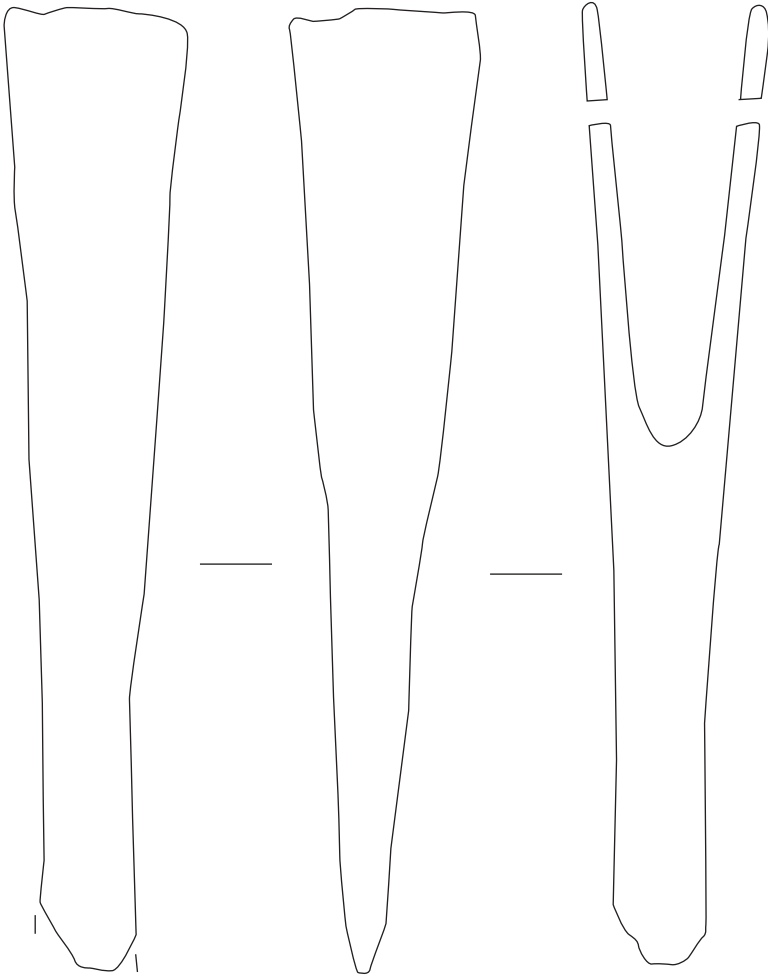

n°1 : D'après Sievers 1984, n°1858

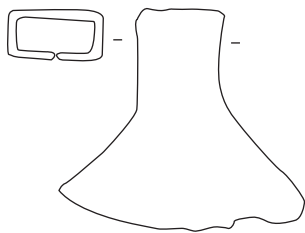

n°2 : D'après Sievers 1984, n°1858



n°3 : D'après Sievers 1984, n°1857

n°1 à 3 : fer

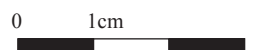



n°1 : D'après Sievers 1984, n°1913

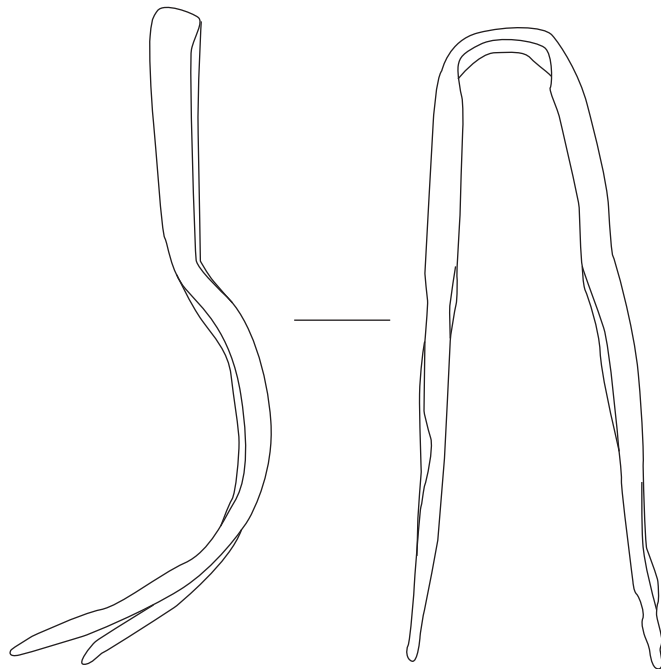

n°2 : D'après Sievers 1984, n°2023



n°1-2 : fer

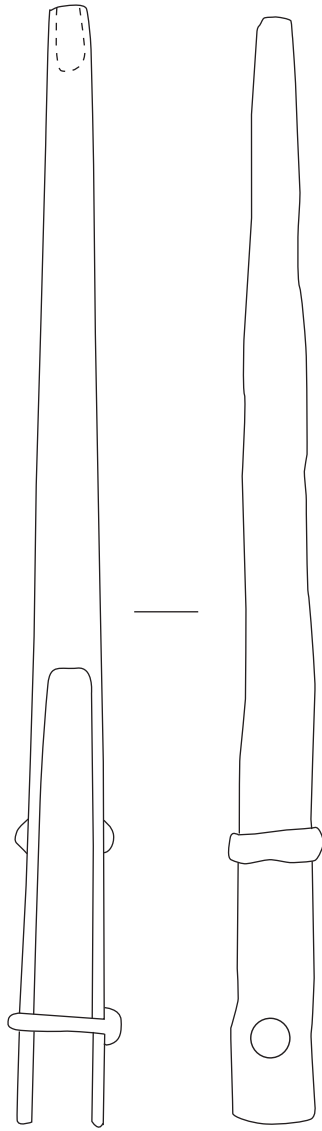

n°1 : D'après Sievers 1984, n°1975

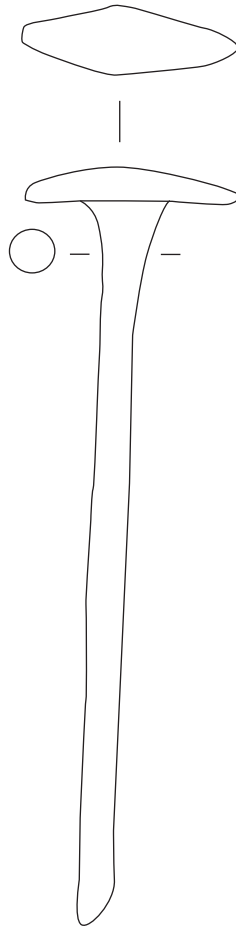

n°2 : D'après Sievers 1984, n°2061

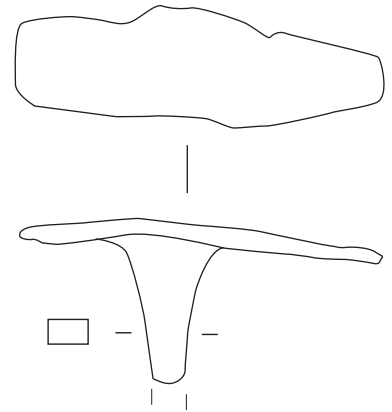

n°3 : D'après Sievers 1984, n°2058

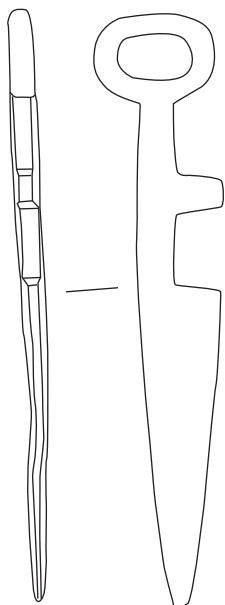

n°4 : Sievers 1984, n°1469

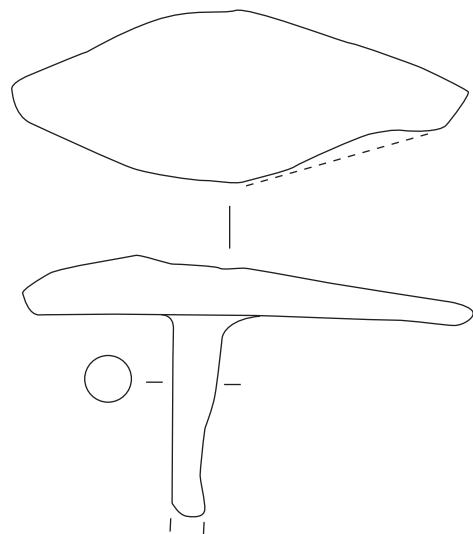

n°5 : D'après Sievers 1984, n°2062

n°1 à 5 : fer sauf n°4 : bronze

0 1cm



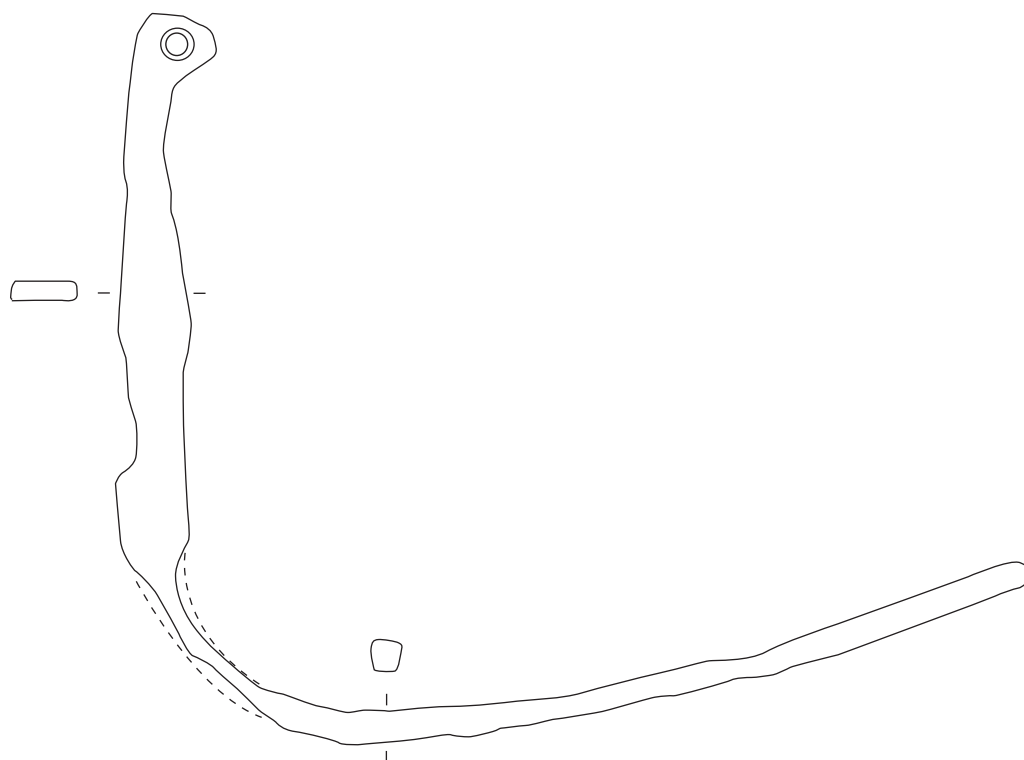

n°1 : D'après Sievers 1984, n° 1988

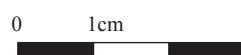

n°1 : fer

**Salins-les-Bains**  
**Camp du Château**

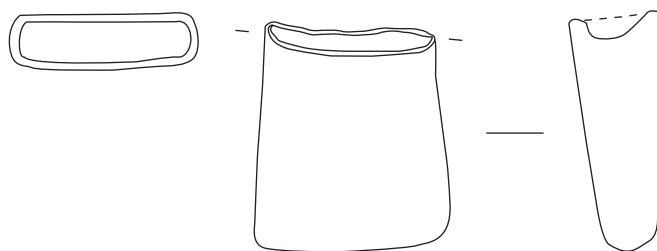

n°1 : 54695-22

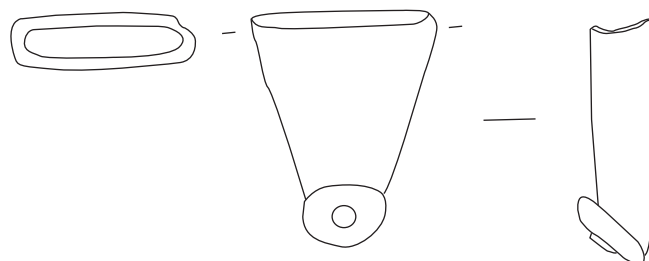

n°2 : 50879-01

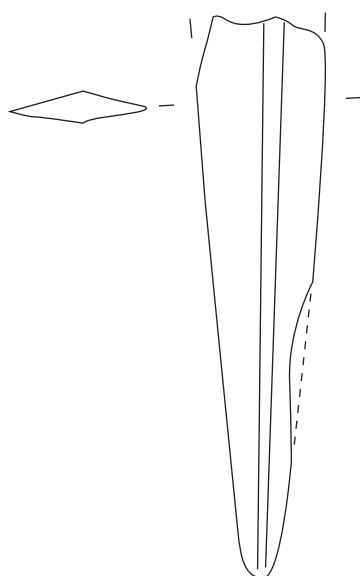

n°3 : 50912-09

n°1 à 3 : fer

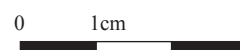

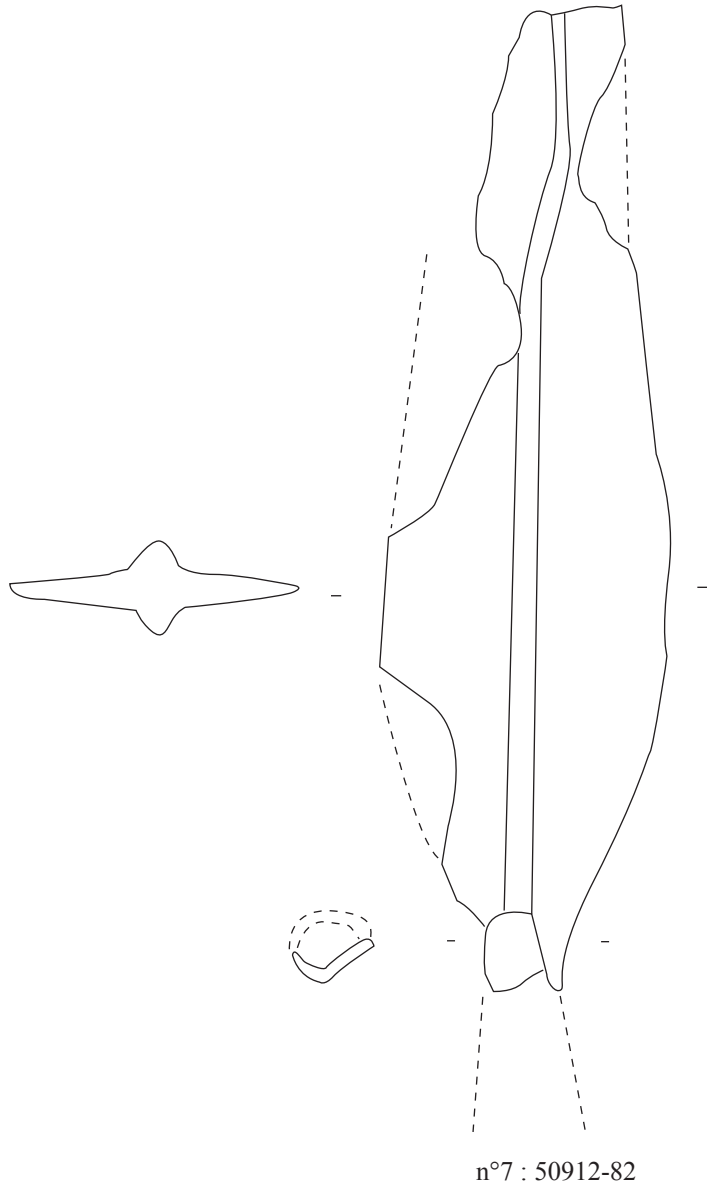
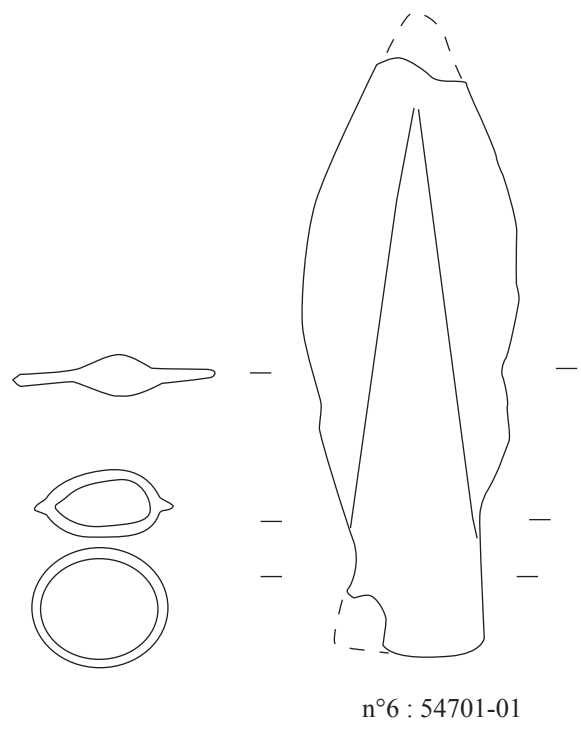
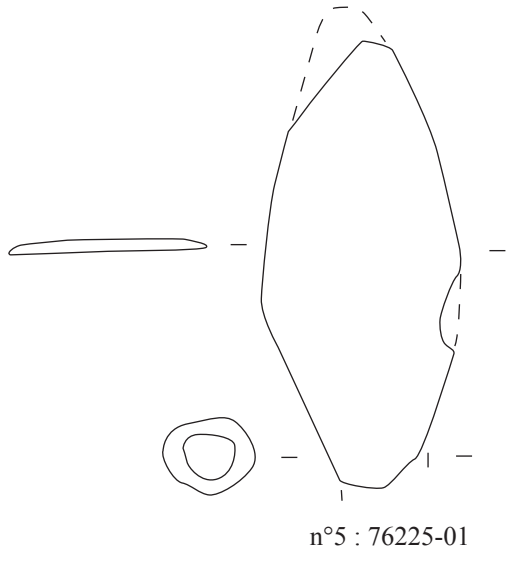
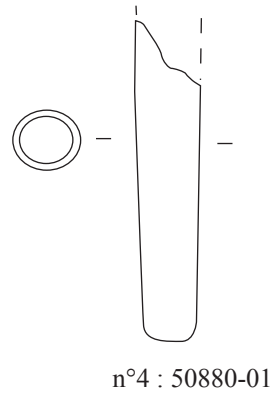
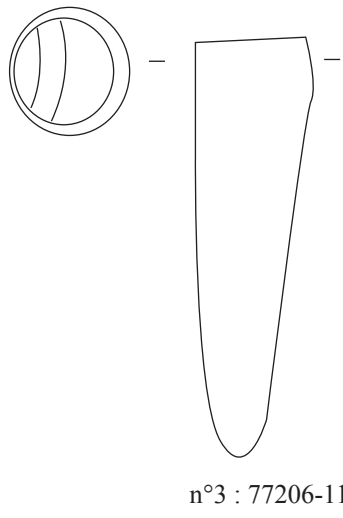
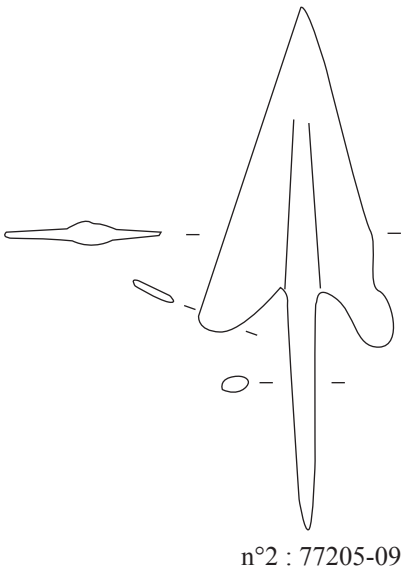
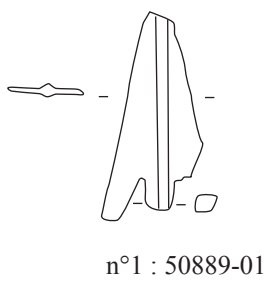

n°1-2 : bronze sinon fer

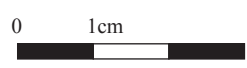



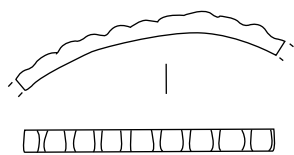

n°1 : 50904-01

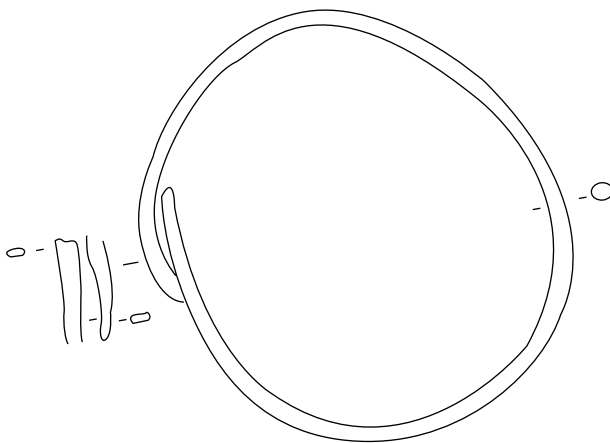

n°2 : 50892-02



n°3 : 54695-13

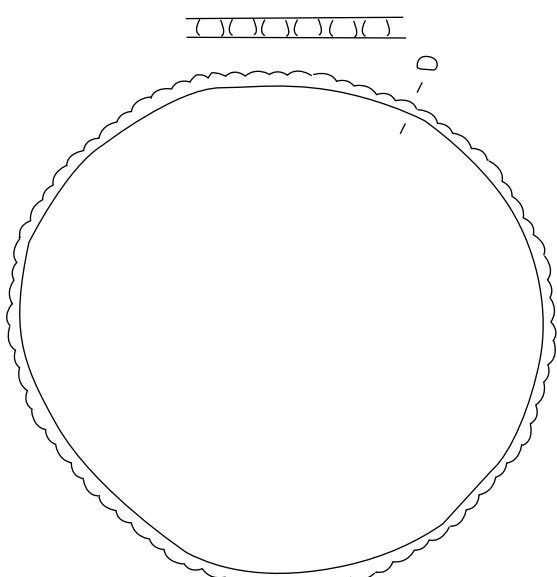

n°4 : 56308-12

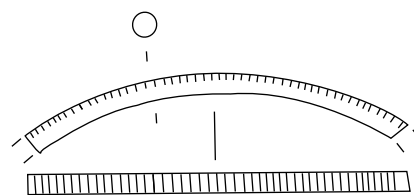

n°5 : 50877-02

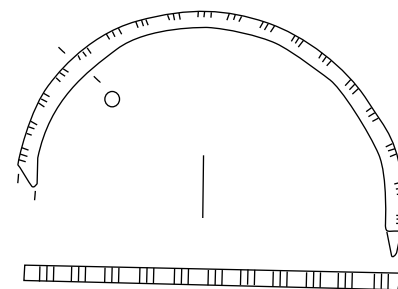

n°6 : 77206-02

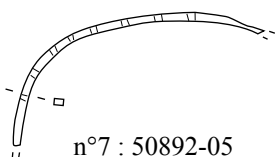

n°7 : 50892-05

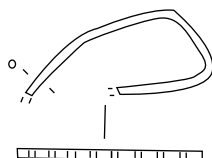

n°8 : 54695-19

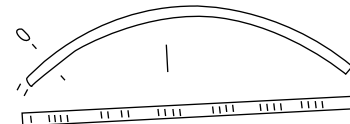

n°11 : 50892-12

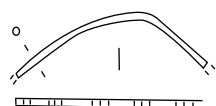

n°9 : 54695-20

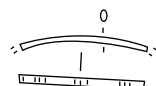

n°10 : 54695-16

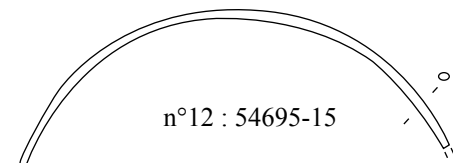

n°12 : 54695-15

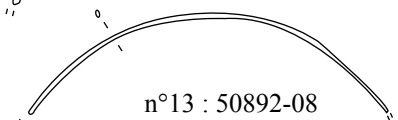

n°13 : 50892-08

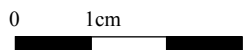

n°1 à 13 : bronze

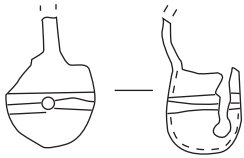

n°1 : 76228-03



d'après V. Ganard  
n°2 : 56308-10

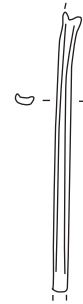

n°3 : 50915-41

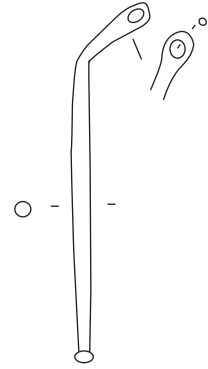

n°4 : 50877-04

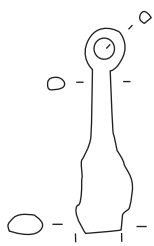

n°5 : 50914-02

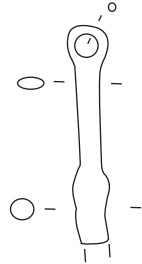

n°6 : 77206-05

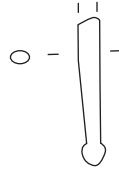

n°7 : 50912-06

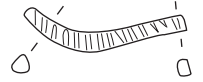

n°8 : 76231-02

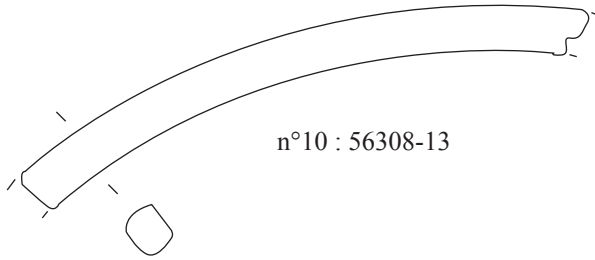

n°10 : 56308-13

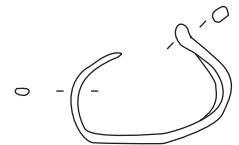

n°9 : 76231-01

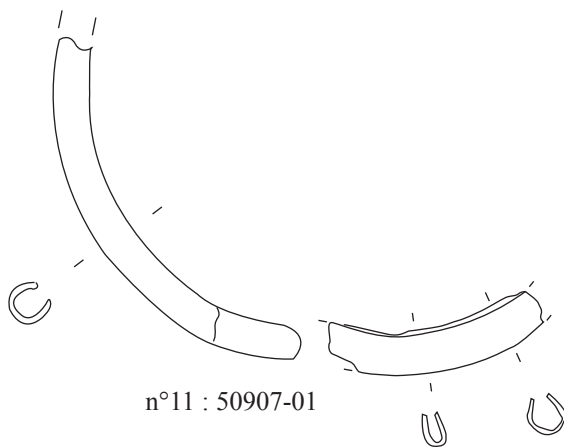

n°11 : 50907-01

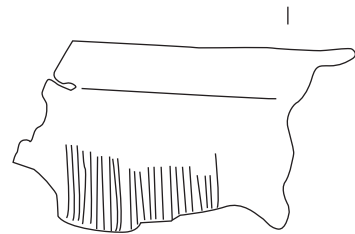

n°12 : 77206-07

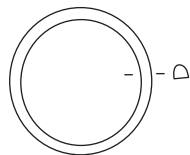

n°13 : 76232-04

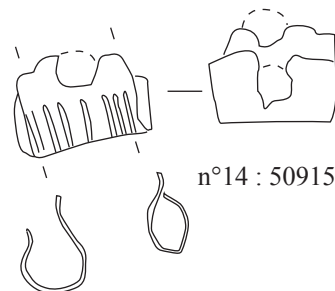

n°14 : 50915-06

n°1 à 4-8 à 14 : bronze ; n°5 à 7 : fer

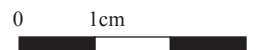

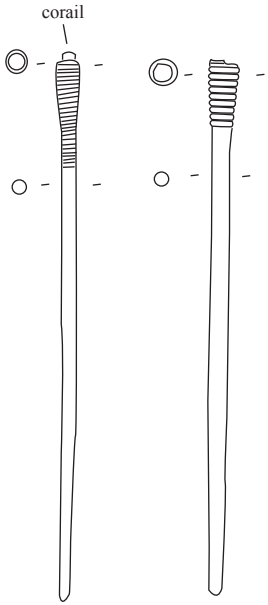

n°1 :  
54693-01

n°2 :  
56308-06

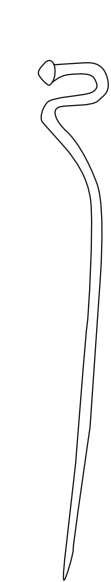

d'après V. Ganard  
n°3 :  
50902-01



n°4 :  
56308-05

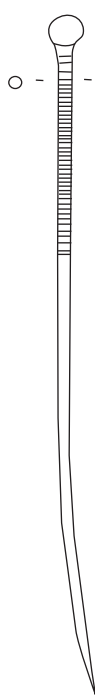

n°5 :  
76235-01



n°6 :  
50891-01

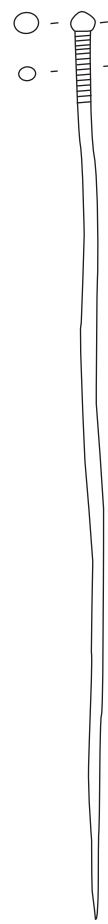

n°7 :  
56307-08

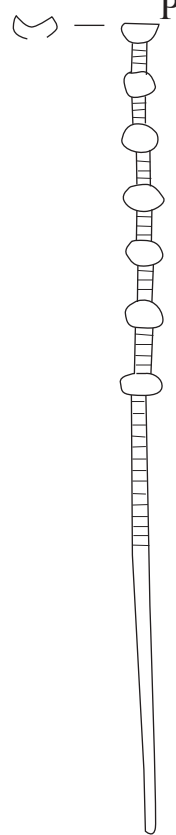

d'après V. Ganard  
n°8 :  
50891-04

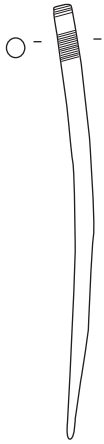

n°9 : 56308-02

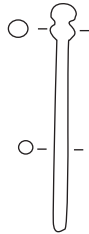

n°10 :  
50891-01

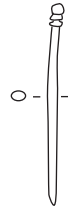

n°11 :  
77206-14

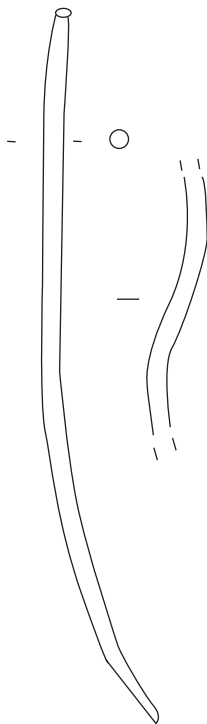

n°12 : 60863-01

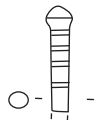

n°13 :  
50915-29



n°14 :  
50890-01

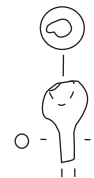

n°15 :  
50915-30

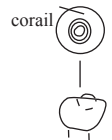

n°16 :  
50915-07

n°1 à 16 : bronze sauf n°13 : fer

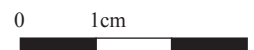

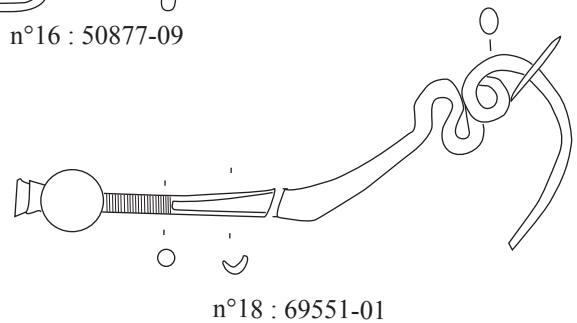
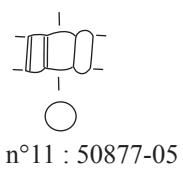
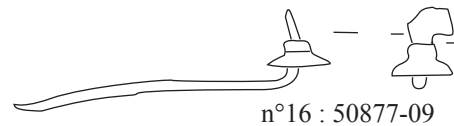
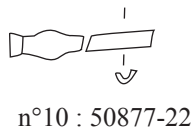
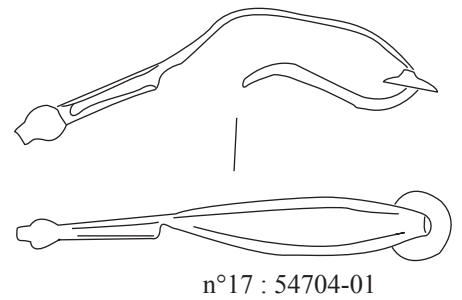
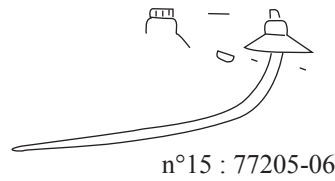
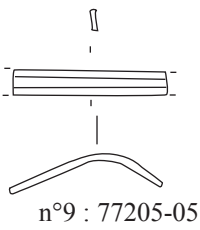
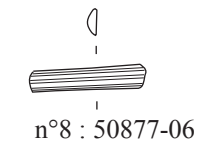
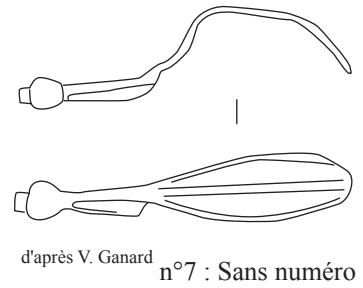
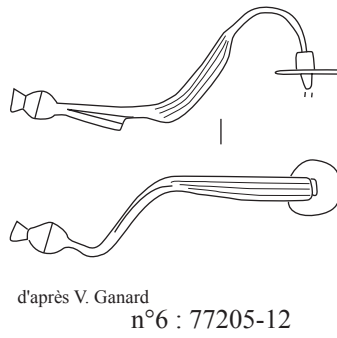
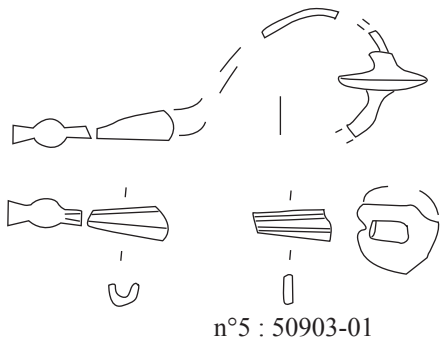
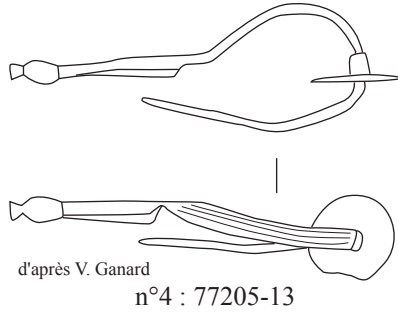
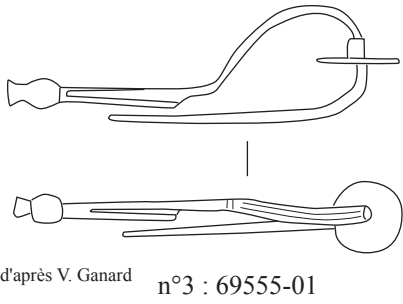
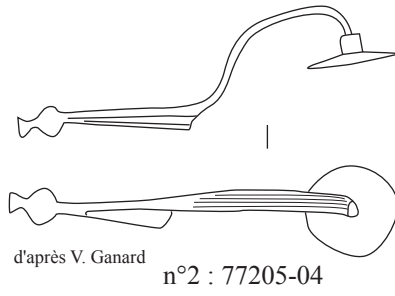
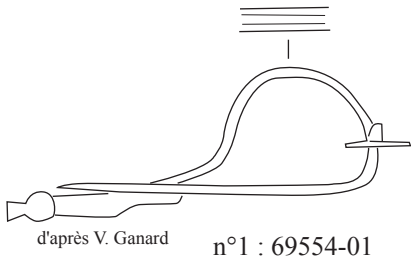

n°1 à 18 : bronze

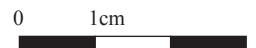

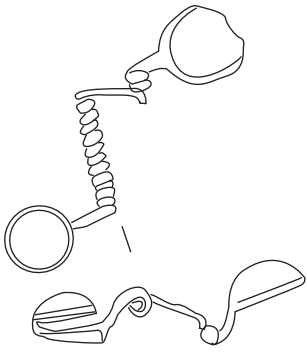

n°1 : 50906-01/02

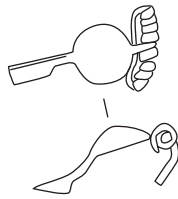

n°4 : 69560-01

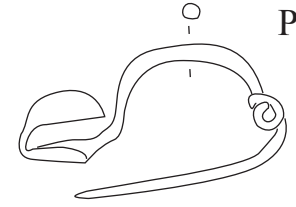

n°8 : 50886-01



n°5 : 69559-01

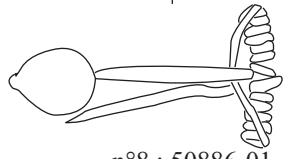

n°9 : 69556-01

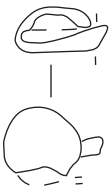

n°2 : 54703-01

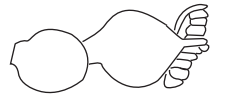

n°6 : 50887-01

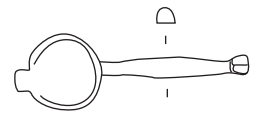

n°10 : Sans numéro



n°3 : 77206-06



d'après V. Ganard

n°6 : 50887-01



d'après V. Ganard

n°10 : Sans numéro

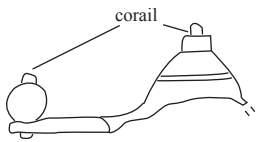

n°12 : 77206-19



n°7 : 50909-01

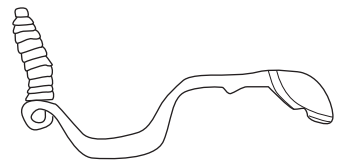

d'après V. Ganard

n°11 : 69558-01

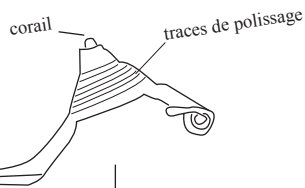

n°13 : 77206-18

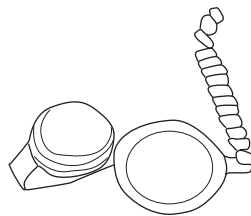

d'après V. Ganard

n°14 : 76230-01

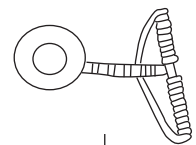

d'après V. Ganard

n°15 : 69557-01

n°1 à 15 : bronze

0 1cm

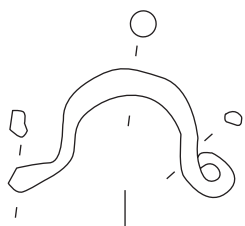

n°1 : 51352-01

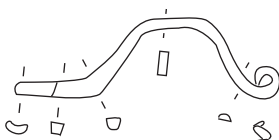

n°4 : 50882-01

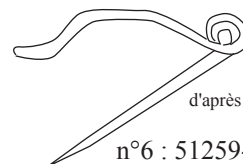
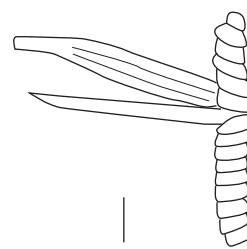

d'après V. Ganard

n°6 : 51259-01

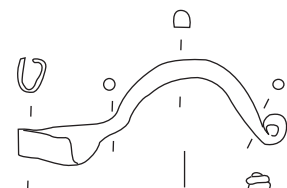

n°2 : 77206-03

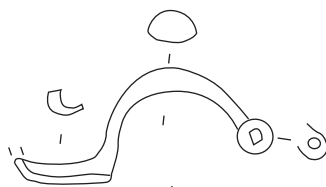

n°5 : 77206-13

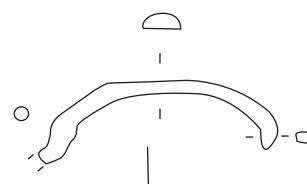

n°7 : 50877-20

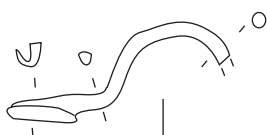

n°3 : 76227-01

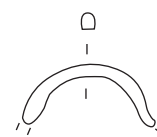

n°8 : 50877-19

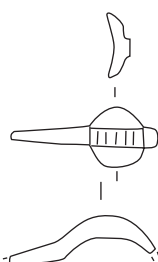

d'après V. Ganard

n°9 : 77206-15

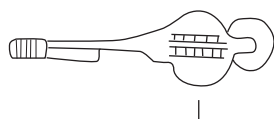

d'après V. Ganard

n°10 : 50894-01



n°1-7 : fer sinon bronze

0 1cm



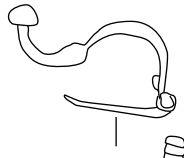

d'après V. Ganard  
n°1 : 77206-04

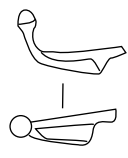

n°3 : 77206-16

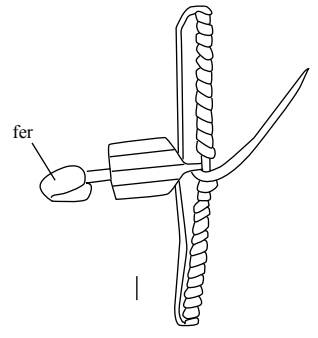

d'après V. Ganard  
n°5 : 50893-01



d'après V. Ganard  
n°2 : 77206-09

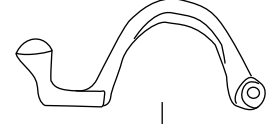

n°4 : 77206-17

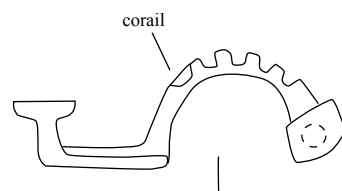

d'après V. Ganard  
n°7 : 50884-01

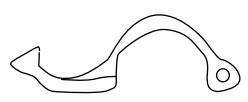

d'après V. Ganard  
n°8 : 50885-03

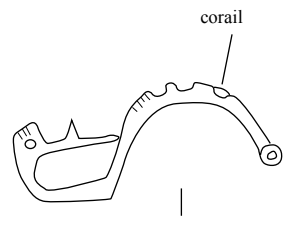

d'après V. Ganard  
n°6 : 50883-01

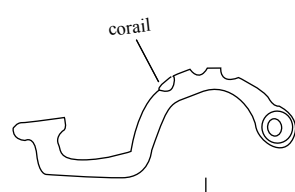
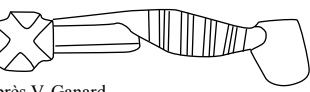

n°10 : 56307-01

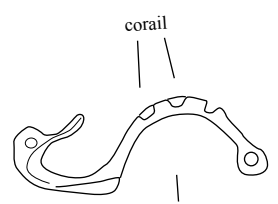

d'après V. Ganard  
n°9 : 69561-01

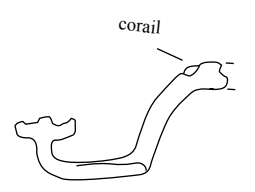
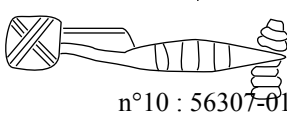

n°11 : 51351-01

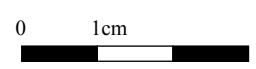

n°3 : fer sinon bronze

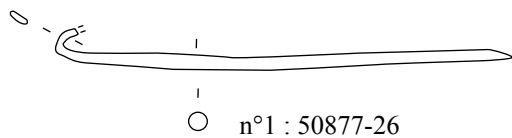

n°1 : 50877-26

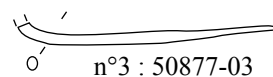

n°3 : 50877-03

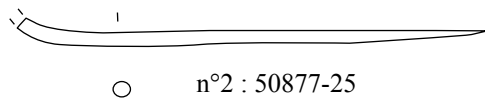

n°2 : 50877-25

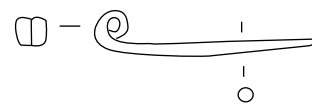

n°4 : 50877-04



n°8 : 50877-24

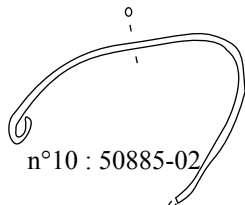

n°10 : 50885-02

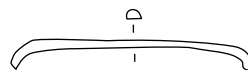

n°12 : 50877-11

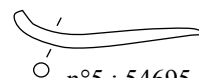

n°5 : 54695-14



n°9 : 54695-18

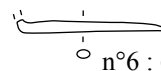

n°6 : 618

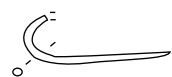

n°7 : 50877-17

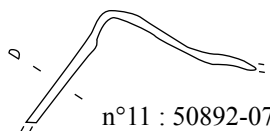

n°11 : 50892-07

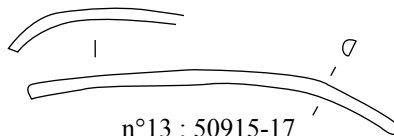

n°13 : 50915-17

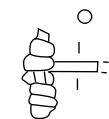

n°14 : 50877-13

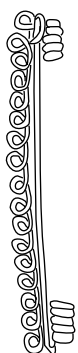

n°19 : 76228-02



n°22 : 77205-11



n°15 : 50877-16



n°16 : 77205-03



n°23 : 50877-23



n°17 : 50877-15



n°20 : 77205-01



n°24 : 50915-43

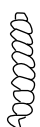

n°18 : 50877-14

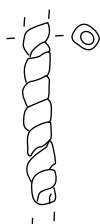

n°21 : 76228-01

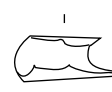

n°25 : 50877-07

n°1 à 25 : bronze sauf n°15 : fer

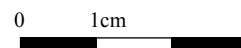



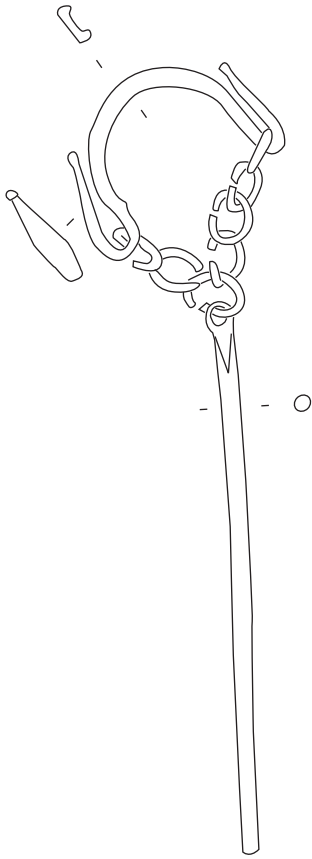

n°1 : 56308-14

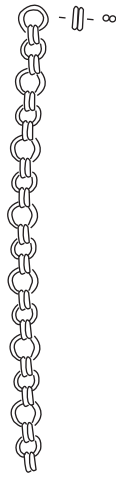

n°2 : 50915-42



n°3 : 50875-01



n°4 : 76234-01



n°5 : 56306-02

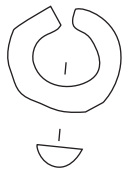

n°6 : 54695-06

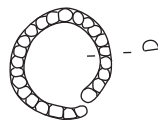

n°8 : 50915-03



n°7 : 76232-02

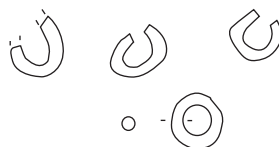

n°9 : 50915-34



n°1 à 9 : bronze

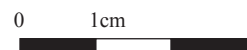

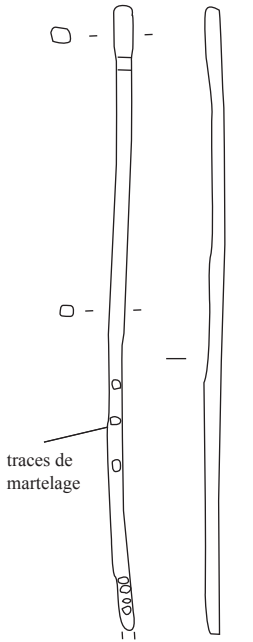

n°1 : 50915-23

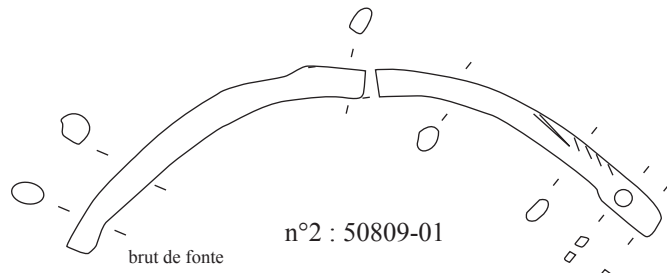

n°3 : 51352-05

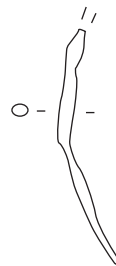

n°4 : 51352-06

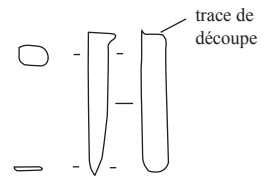

n°5 : 54695-22

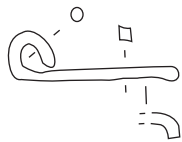

n°6 : 50896-01

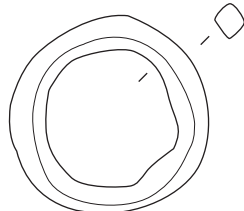

n°7 : 76232-05

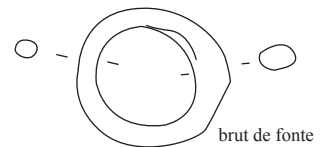

n°8 : 69610-01

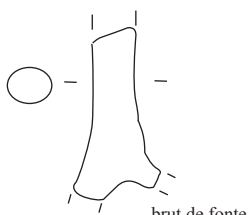

n°9 : 76227-04

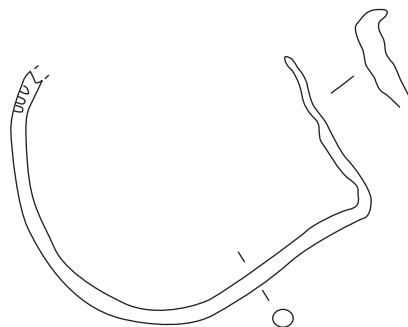

n°10 : 50901-01

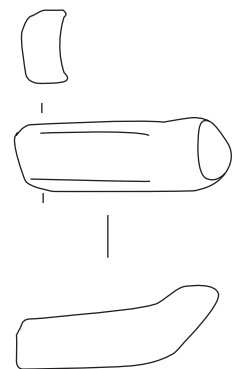

n°11 : 50914-04

n°1 à 10 : bronze ; n°11 : fer

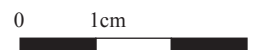

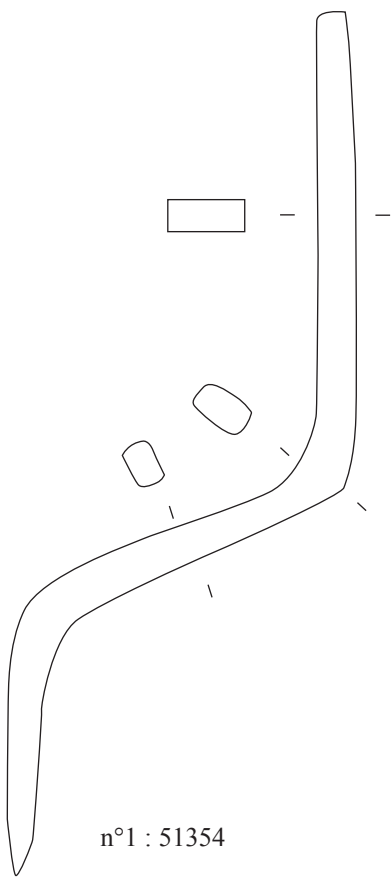

n°1 : 51354

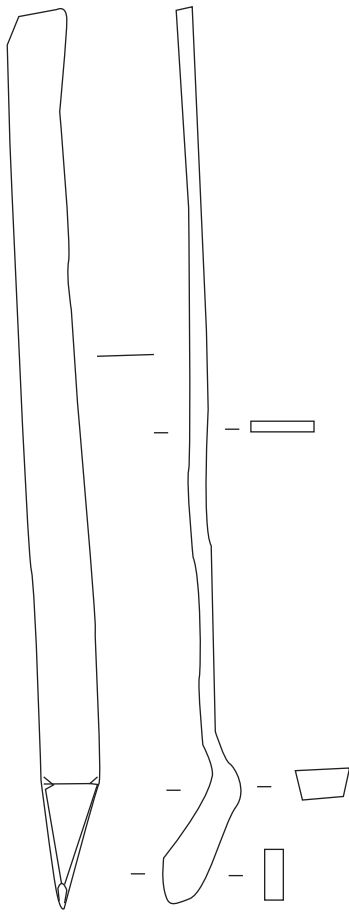

n°2 : 83221-02

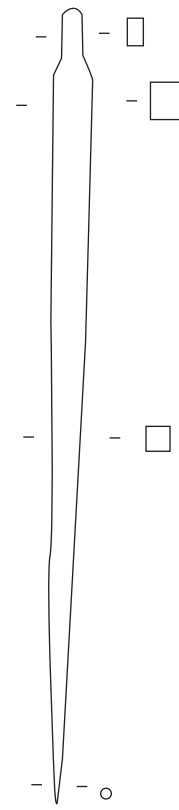

n°3 : 77206-08

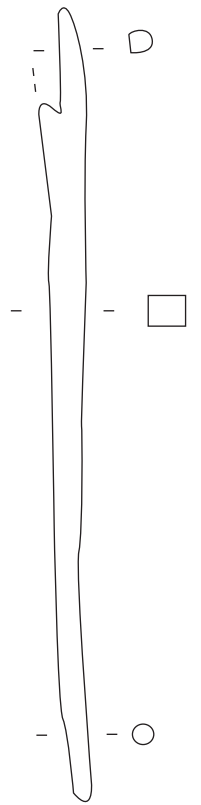

n°4 : 50876-01

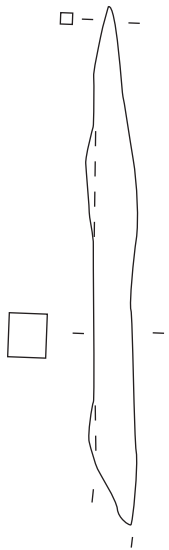

n°5 : 50912-10

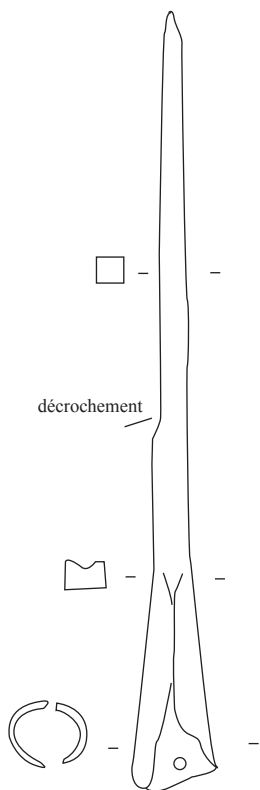

n°6 : 77206-12

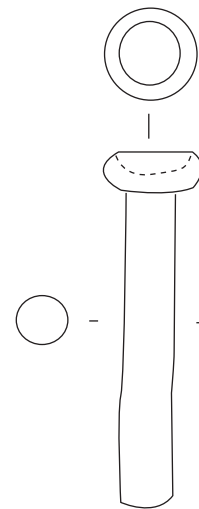

n°7 : 76239-01

n°1 à 6 : fer ; n°7 : bronze

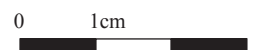



d'après V. Ganard  
n°1 : 56308-09



d'après V. Ganard  
n°2 : Sans numéro



d'après V. Ganard  
n°3 : Sans numéro



n°4 : 50892-15



n°5 : 50892-14

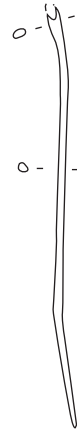

n°6 : 50912

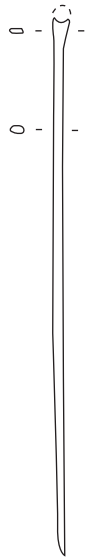

n°7 : 50892-01



n°8 :  
50899-01



n°9 :  
50912-17

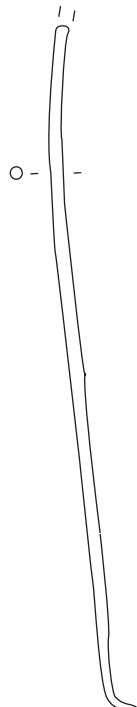

n°10 :  
50898-01



n°11: 50892-13

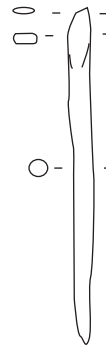

n°12 : 50892-20

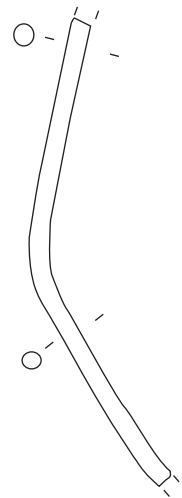

n°17 : 54695-07

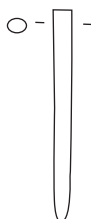

n°13 : 50912-68

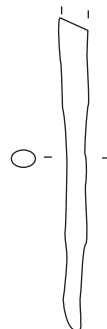

n°14 : 83221-04

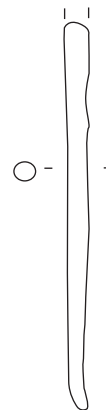

n°15 : 50892-19

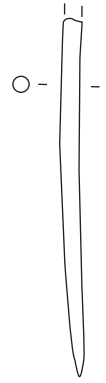

n°16 : 50912-17

n°1 à 17 : bronze sauf n°14 : fer

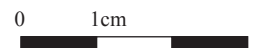

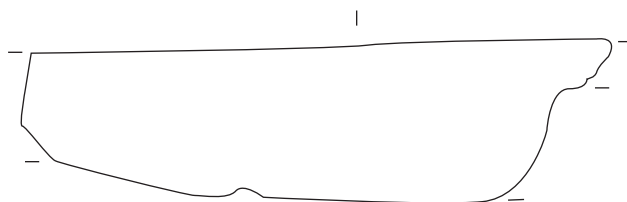

I



n°1 : 51256-02

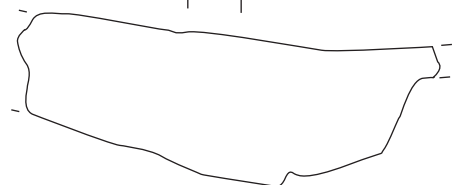

I



n°2 : 51256-03

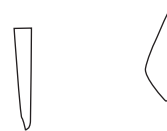
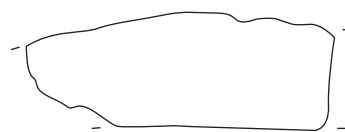

n°3 : 83221-03

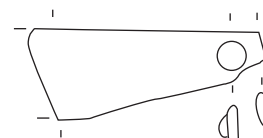

n°4 : 50912-12

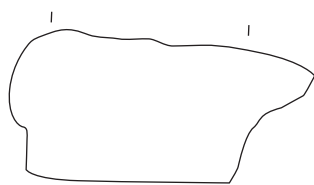

n°5 : 50912-01

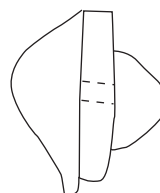

I

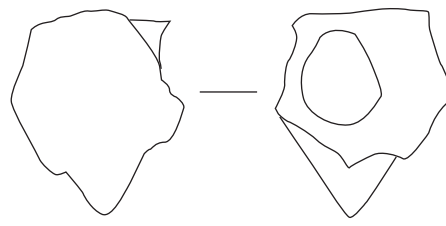

n°6 : 50912-02

n°1 à 6 : fer

0 1cm

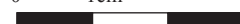

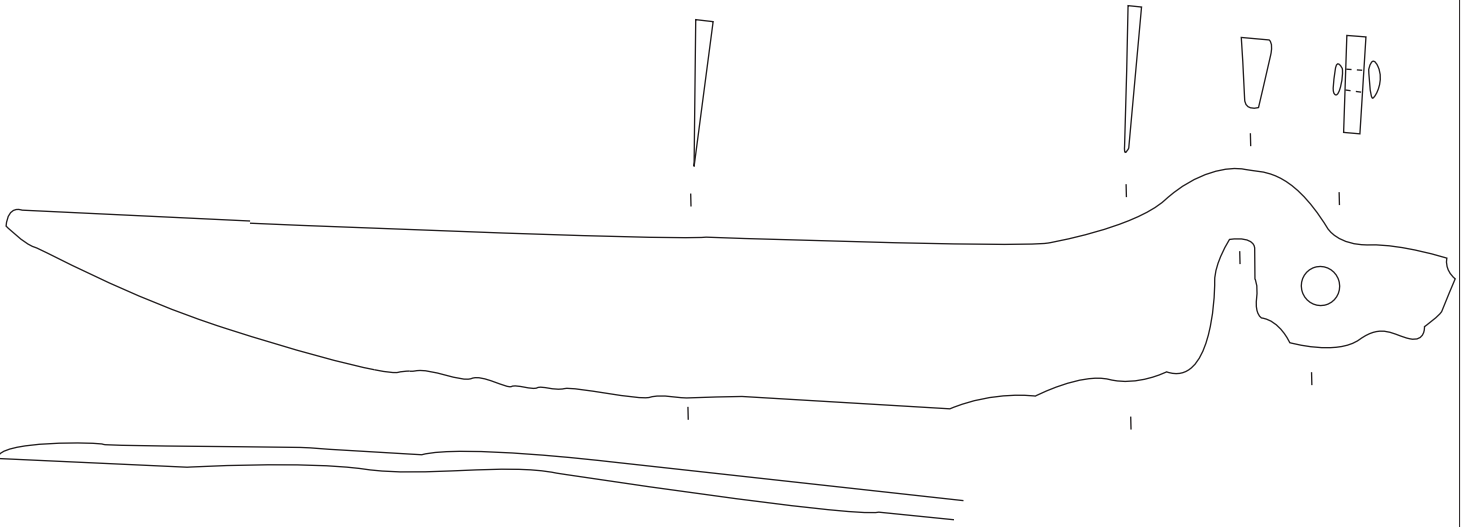

n°1 : 77206-10

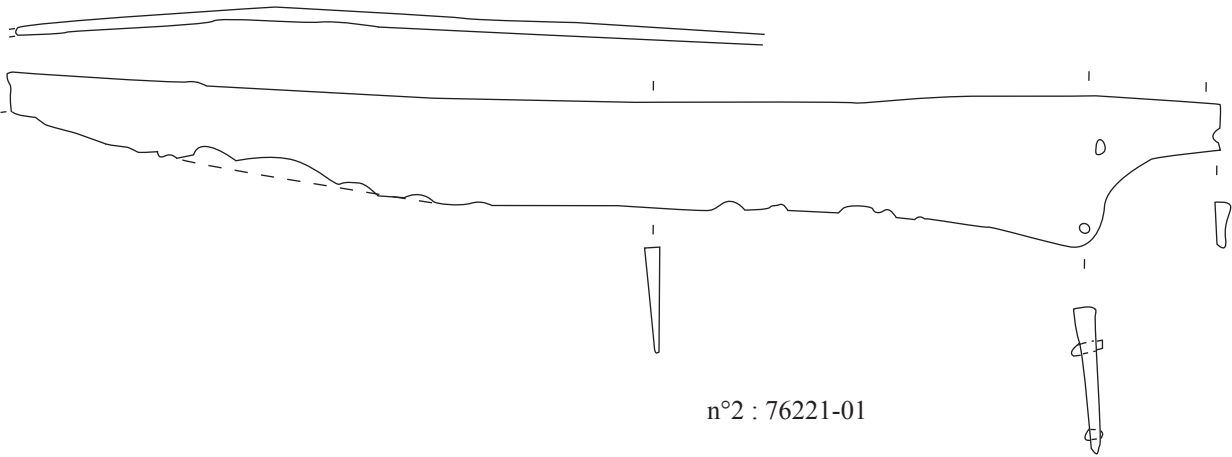

n°2 : 76221-01

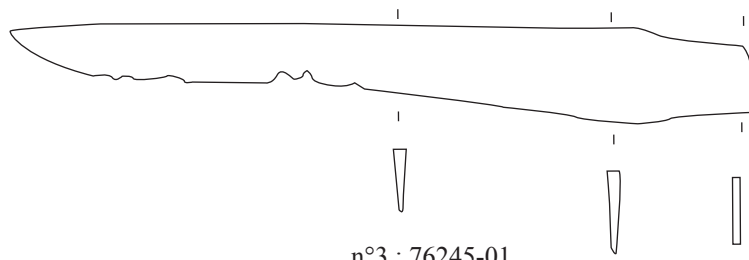

n°3 : 76245-01

n°1 à 3 : fer

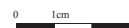

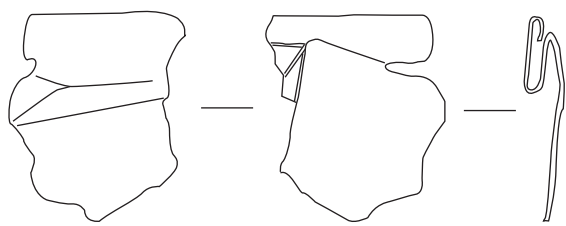

n°1 : 50905-01

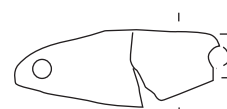

n°2 : 50915-08

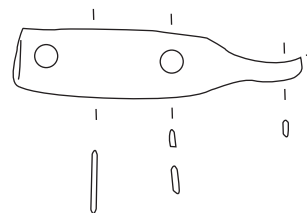

n°3 : 76224-01

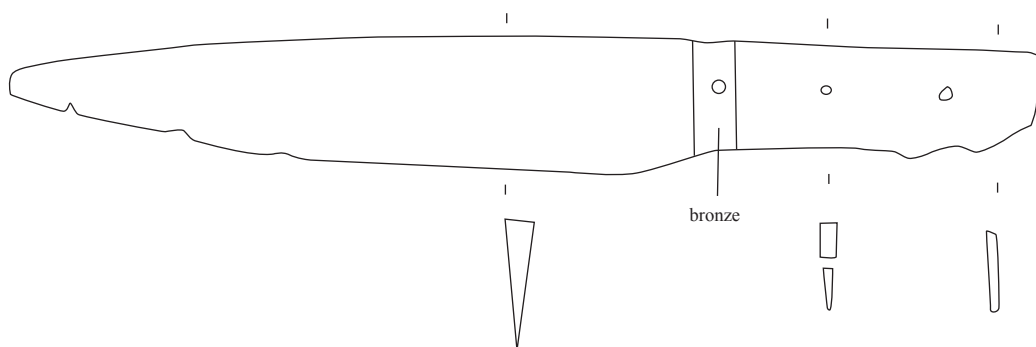

n°4 : 76206-01

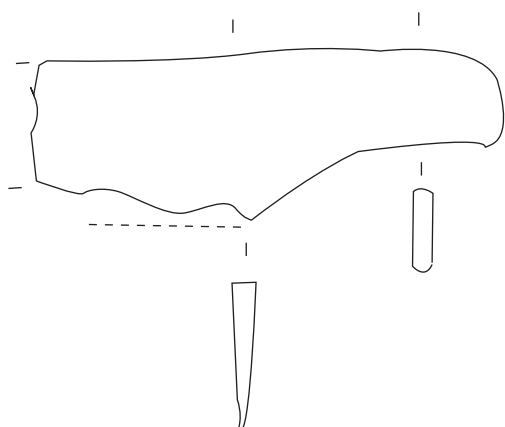

n°5 : 50912-05

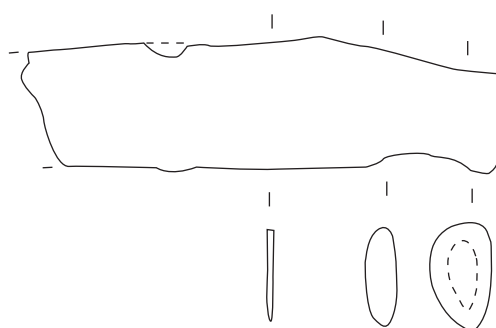

n°6 : 50872-01

n°1 à 3 : bronze ; n°4 à 6 : fer





n°1 : Sans numéro



n°1 à 2 : fer

n°2 : 50871





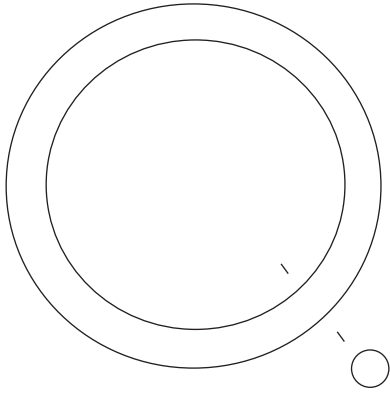

n°1 : 77205-07

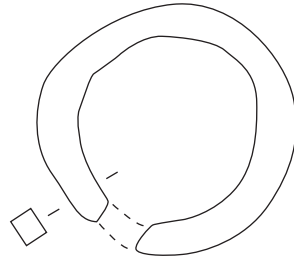

n°2 : 50877-18

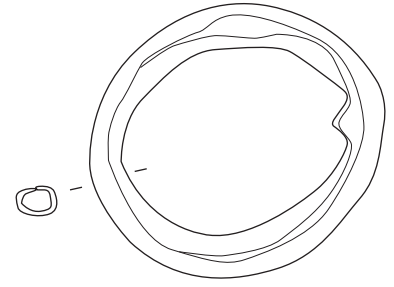

n°3 : 50915-22

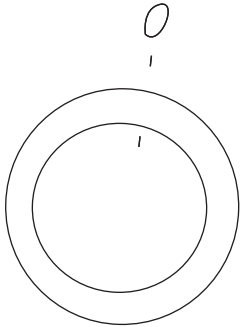

n°4 : 50914

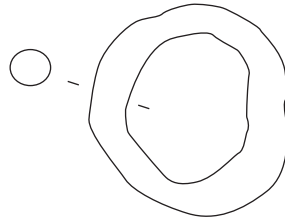

n°5 : 76238

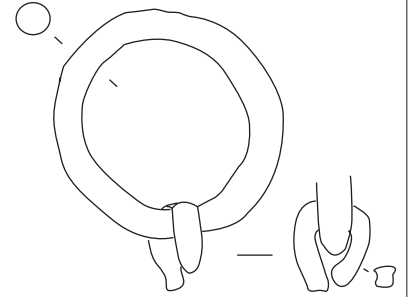

n°6 : 56306-01

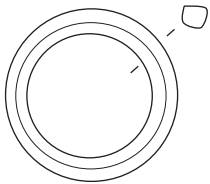

n°7 : 50912-19

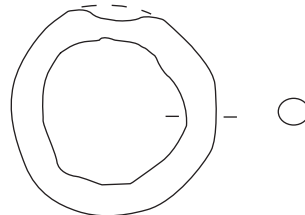

n°8 : 76238

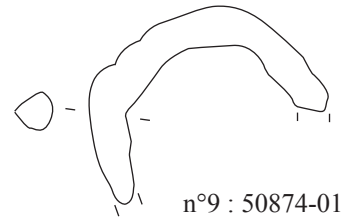

n°9 : 50874-01

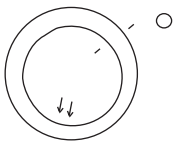

traces d'usure  
n°10 : 50877-01

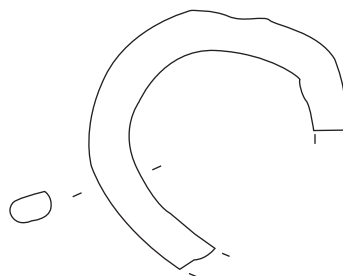

n°11 : 50874-01



n°12 : 51257-02

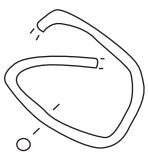

n°13 : 50915-04



n°14 : 50912-89



n°15 : 50915-28

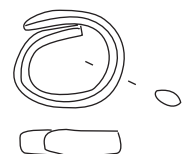

n°16 : 76232-01

n°1 à 4-7-10-11-13 à 16 : bronze sinon fer



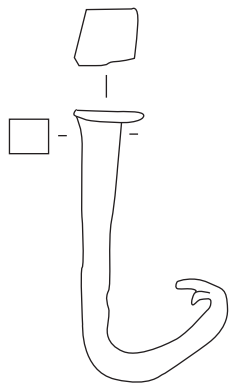

n°1 : 50912-11

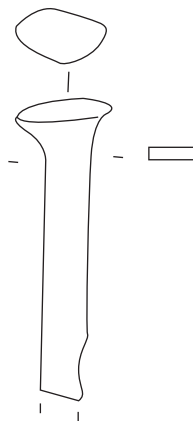

n°2 : 60862-02

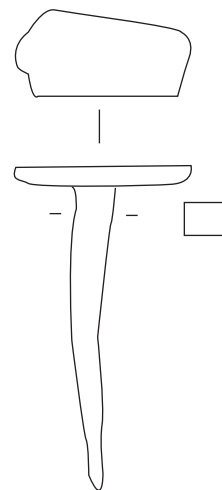

n°3 : 60862-01

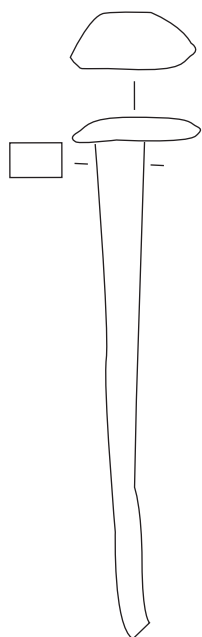

n°4 : 54696-01



n°5 : 51352-03

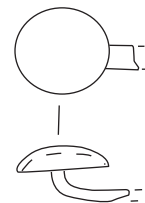

n°6 : 50915-15



n°7 : 50915-20

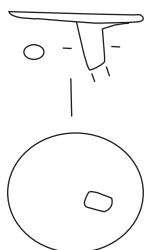

n°8 : 50912-07



n°9 : 50915-31

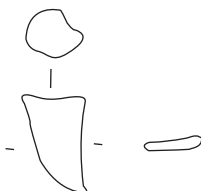

n°10 : 50915-39

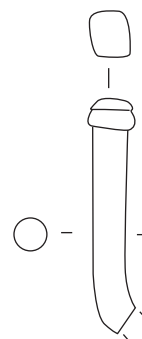

n°11 : 51352-02

n°1 à 5-8 : fer ; n°6-7-9 à 11 : bronze

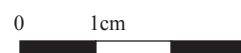

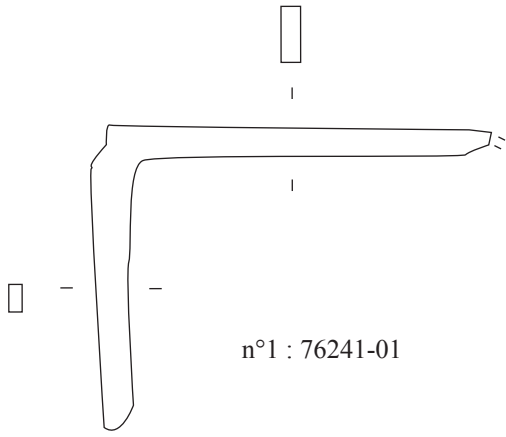

n°1 : 76241-01

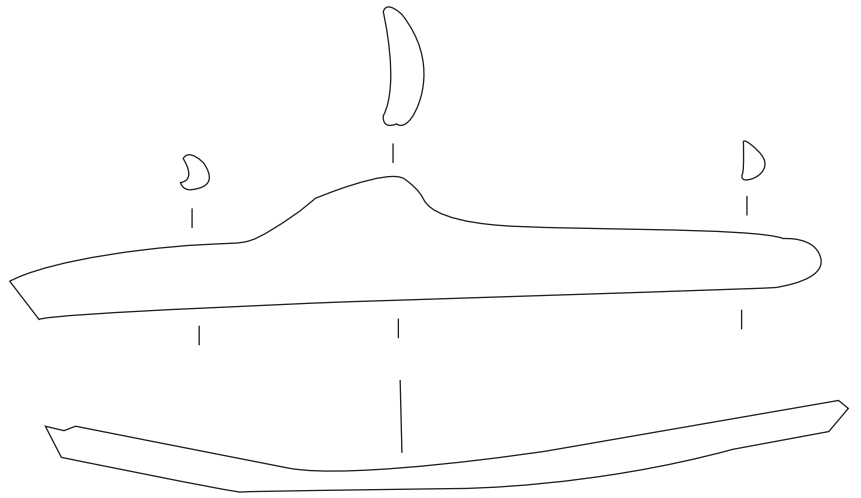

n°2 : 76222-01

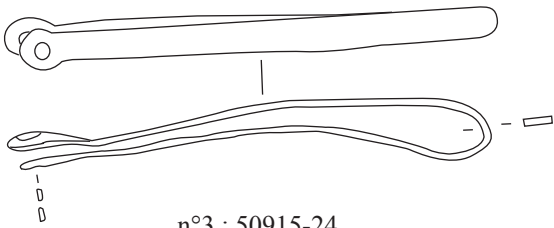

n°3 : 50915-24

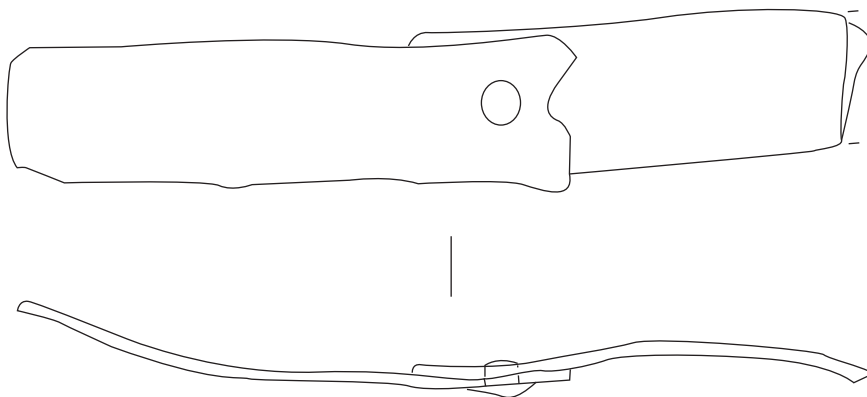

n°4 : 83221-01

n°1 à 2-4 : fer ; n°3 : bronze

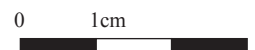

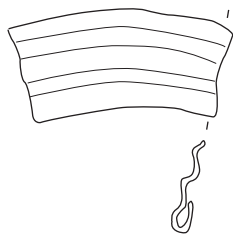

n°1 : 56388-01



n°2 : 77206

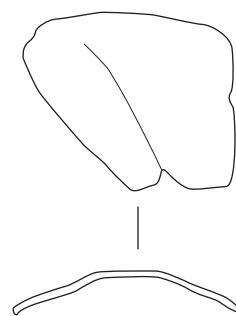

n°3 : 54695-09

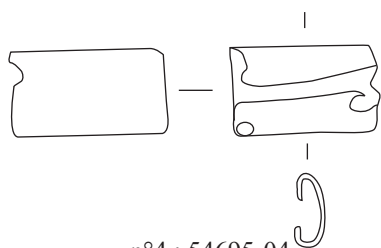

n°4 : 54695-04

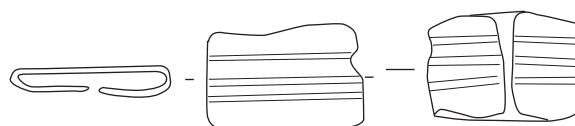

n°5 : 54695-08

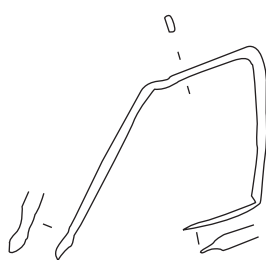

n°6 : 50892-11

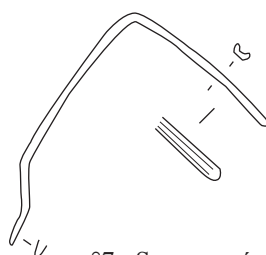

n°7 : Sans numéro

n°1-4 à 7 : bronze ; n°2-3 : fer

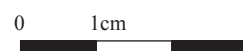



Messein  
Camp d'Affrique

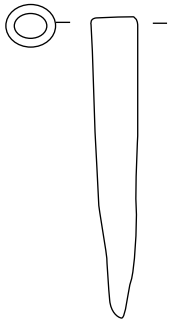

n°1 : 12G'-4f

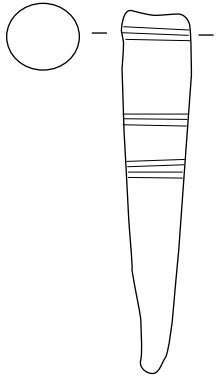

n°2 : D'après Lagadec 1989, Fig. 28, n°5

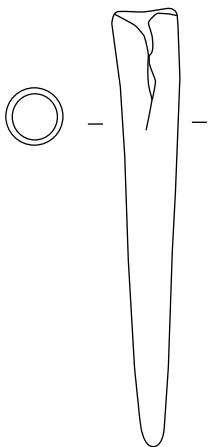

n°3 : B'5-5g  
D'après Lagadec 1989, Fig. 29, n°3

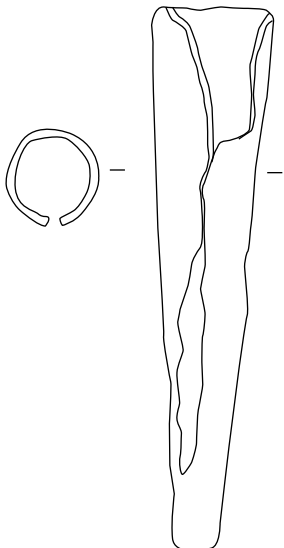

n°4 : 9D'-1e ;  
D'après Lagadec 1989, Fig. 28, n°3

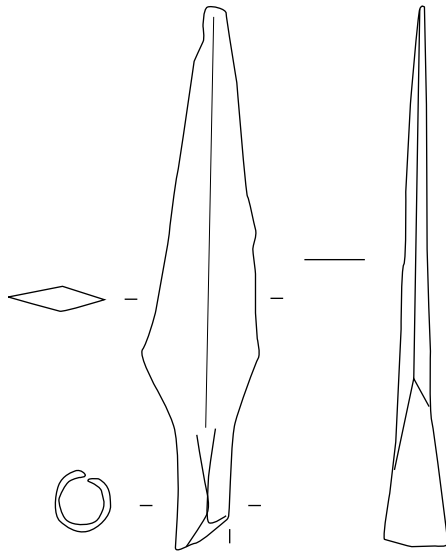

n°5 : 989.123 ; D'après Lagadec 1989, Fig. 28, n°1

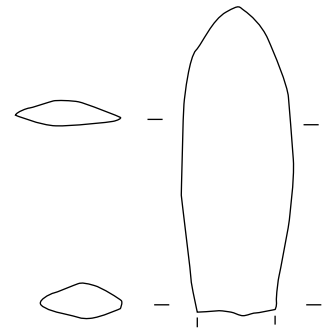

n°6 : G'2-4f ;  
D'après Lagadec 1989, Fig. 28, n°8

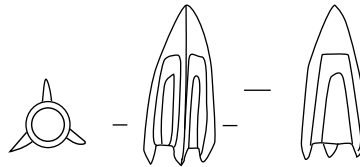

n°7 : D'après Lagadec 1989, Fig. 11

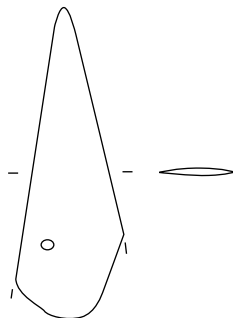

n°8 : B'8-5f

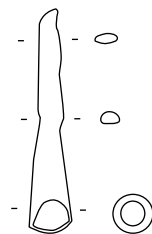

n°9 : B'9-6g

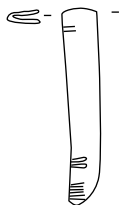

n°10 : B'7-10g

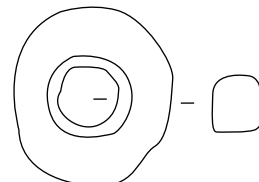

n°11 : 11A-2g ;  
D'après Lagadec 1989, Fig. 23, n°24

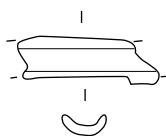

n°12 : 12C'-2f

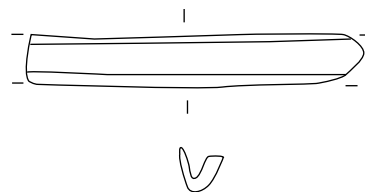

n°13 : 12C'-2e

n°1 à 13 : fer sauf n°7 : bronze

0 1cm

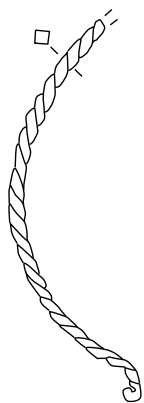

n°1 : D'après Lagadec 1989, Fig. 40, n°1

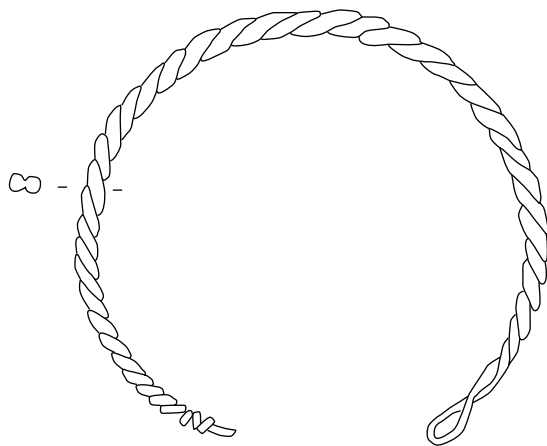

n°2 : D'après Lagadec 1989, Fig. 39, n°10

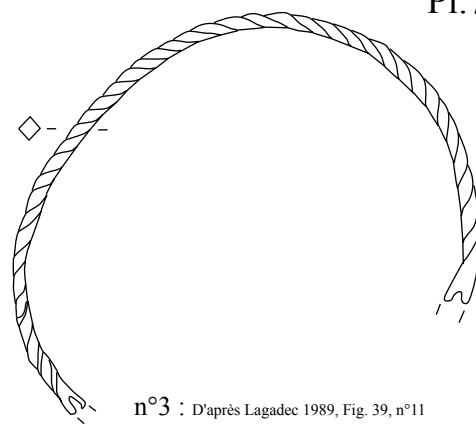

n°3 : D'après Lagadec 1989, Fig. 39, n°11

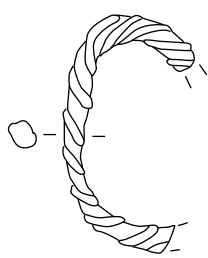

n°4 : 1E'1f ;  
D'après Lagadec 1989, Fig.24, n°13



n°6 : 6G'-1f ; D'après Lagadec 1989,  
Fig. 23, n°6



n°8 : D'après Lagadec 1989, Fig.24, n°14



n°5 : D'après Lagadec 1989, Fig.24, n°1

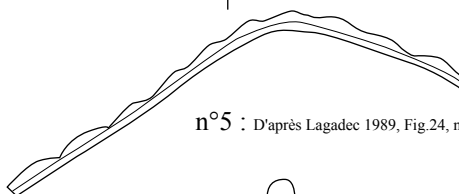

n°7 : 985-3234 ;  
D'après Lagadec 1989, Fig. 24, n°2

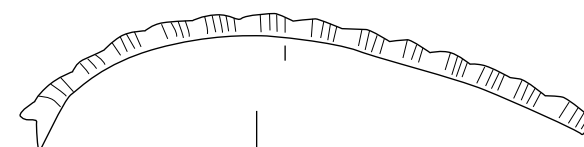

n°9 : 17 J'-9f

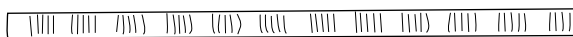

n°11 : Sond.4 ; D'après Lagadec 1989,  
Fig.24, n°7

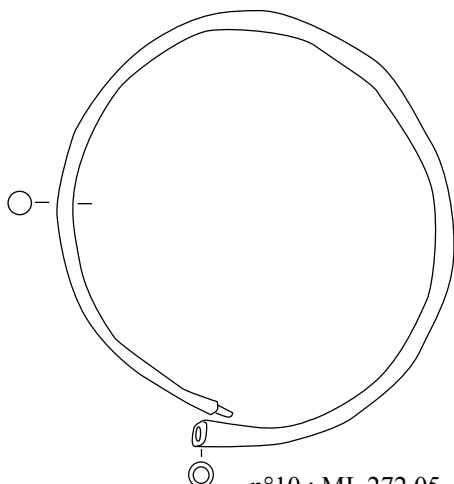

n°10 : ML 272.05  
D'après Lagadec 1989, Fig. 39, n°2

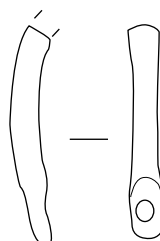

n°12 : ML 280.05 ;  
D'après Lagadec 1989, Fig. 39, n°3

n°1 à 12 : bronze sauf n°7

0 1cm



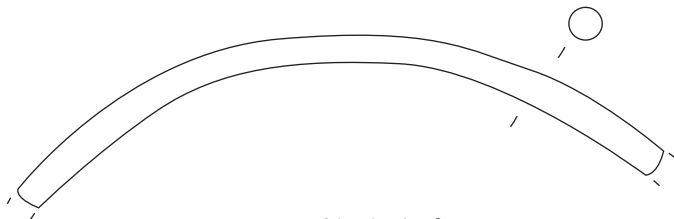

n°1 : 15J'-7f

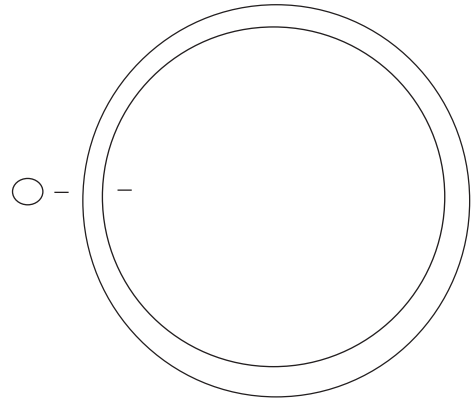

n°3 : D'après Lagadec 1989, Fig. 39

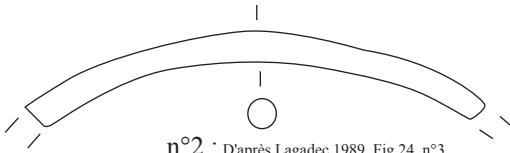

n°2 : D'après Lagadec 1989, Fig.24, n°3

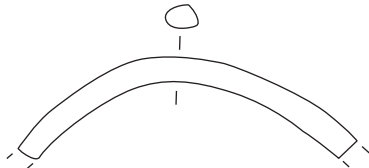

n°4 : D'après Lagadec 1989, Fig.24, n°6

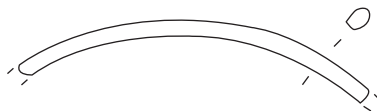

n°5 : B'8-6g

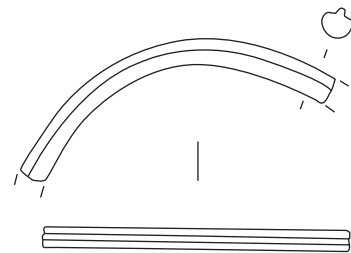

n°6 : D'9-3f

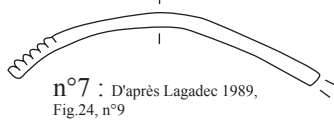

n°7 : D'après Lagadec 1989, Fig.24, n°9

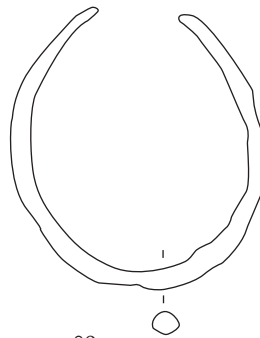

n°9 : D'après Lagadec 1989, Fig. 40, n°6

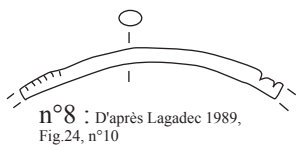

n°8 : D'après Lagadec 1989, Fig.24, n°10

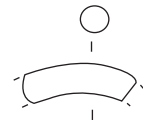

n°10 : 14F'-1e

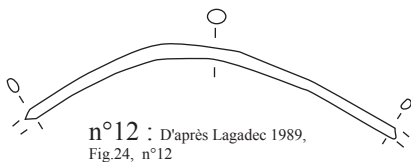

n°12 : D'après Lagadec 1989, Fig.24, n°12

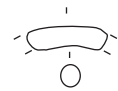

n°11 : 13F'-4g

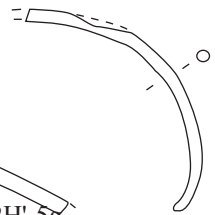

n°13 : 12H'-5g

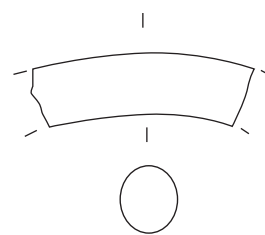

n°15 : D'après Lagadec 1989, Fig.24, n°8

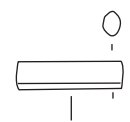

n°16 : 6C'-4g

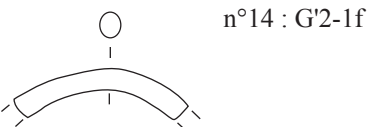

n°14 : G'2-1f

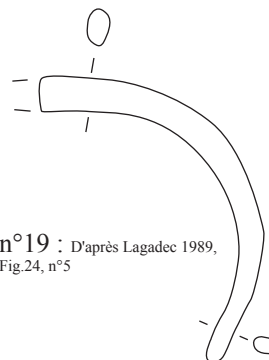

n°19 : D'après Lagadec 1989, Fig.24, n°5

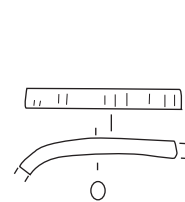

n°20 : 16H'-1g



n°18 : E'5-5f

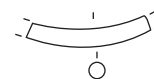

n°21 : 4D'-4f

n°1 à 21 : bronze

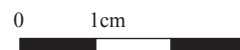

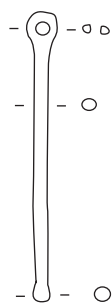

n°1 : A'8-8g

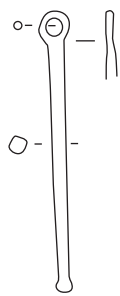

n°2 : 989.1283 ;  
D'après Lagadec 1989,  
Fig. 22, n°1



n°3 : 989.1284 ;  
D'après Lagadec 1989,  
Fig. 22, n°2

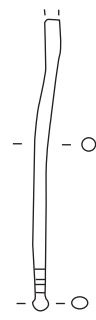

n°4 : 14I'-1g

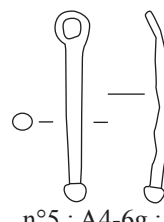

n°5 : A4-6g ;  
D'après Lagadec 1989,  
Fig. 22, n°7

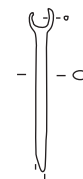

n°6 : D'8-2f

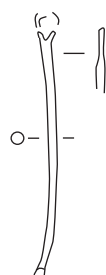

n°7 : 3B'-1f ;  
D'après Lagadec 1989,  
Fig. 22, n°8

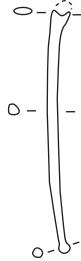

n°8 :  
3B'-1f

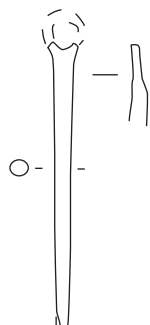

n°9 : 14B'-3f ;  
D'après Lagadec  
1989, Fig. 22, n°3

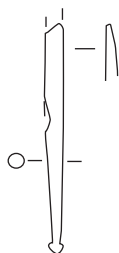

n°10 : 10G'-4f ;  
D'après Lagadec  
1989, Fig. 22, n°6

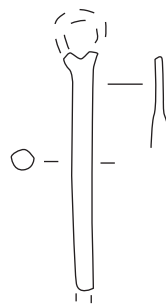

n°11 : D'après Lagadec  
1989, Fig. 22, n°5

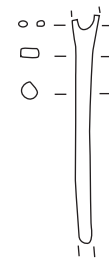

n°11 : B'5-2g

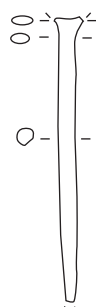

n°12 : 14B'-3f

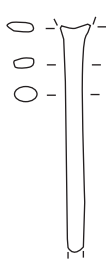

n°13 :  
F'5-6g

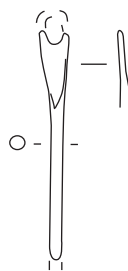

n°14 : D'après Lagadec  
1989, Fig. 22, n°4

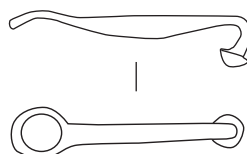

n°15 : E'-2g ; D'après Lagadec 1989,  
Fig.25, n°7

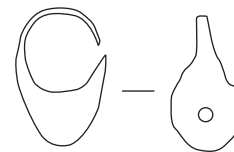

n°16 : Sans numéro ;  
D'après Lagadec 1989,  
Fig. 22, n°14

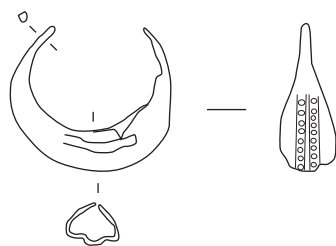

n°17 : XXN.F 26  
D'après Lagadec 1989,  
Fig. 37, n°2

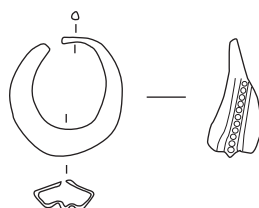

n°18 : ML 298.05 ;  
D'après Lagadec 1989,  
Fig. 37, n°3



n°19 : D'après Lagadec 1989,  
Fig. 23, n°1

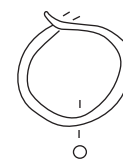

n°20 : D'après Lagadec 1989,  
Fig. 23, n°2



n°21 : C'9-8g



n°22 : 14F'-1e



n°23 : 11E'-5g



n°24 : J'12-4f



n°27 : D'après Lagadec 1989,  
Fig. 38, n°3

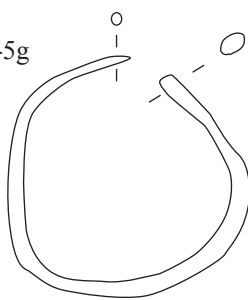

n°28 : XXIV.F34 ;  
D'après Lagadec 1989,  
Fig. 37, n°4

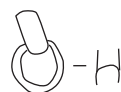

n°25 : C'7-22g



n°26 : D'après Lagadec 1989,  
Fig. 38, n°9

n°1 à 26 : bronze



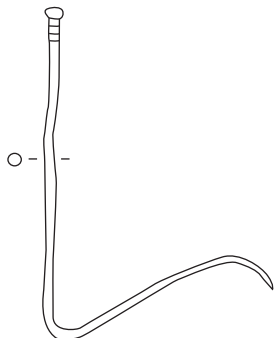

n°1 : B'4-2f ;  
D'après Lagadec 1989,  
Fig. 20, n°15

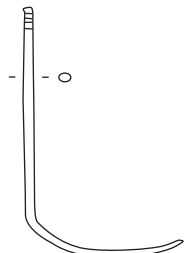

n°2 : B'8-15g

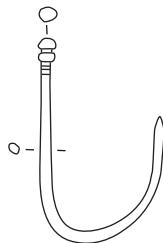

n°3 : Sans numéro  
D'après Lagadec 1989,  
Fig. 21, n°23

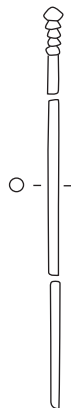

n°4 : D'après Lagadec 1989,  
Fig. 20, n°1

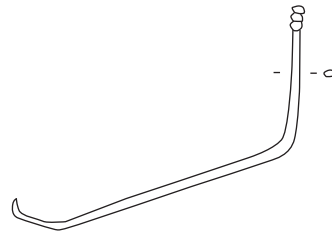

n°5 : G'7-1e



n°6 : D'après Lagadec 1989,  
Fig. 21, n°27



n°7 : D'après Lagadec 1989,  
Fig. 20, n°5

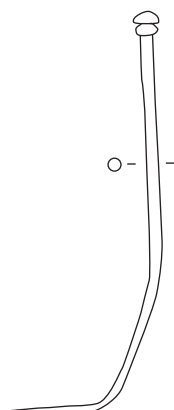

n°8 : 989.1278 ;  
D'après Lagadec 1989,  
Fig. 20, n°21

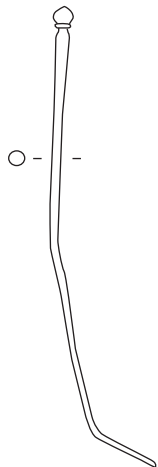

n°9 : 5A'-5g ;  
D'après Lagadec  
1989, Fig. 20, n°14

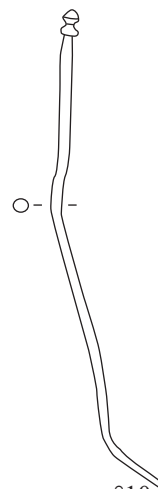

n°10 : D'après  
Lagadec 1989,  
Fig. 20, n°12

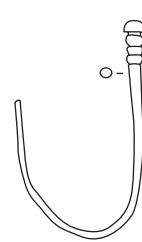

n°11 : D'après Lagadec 1989,  
Fig. 20, n°23



n°12 : D'après  
Lagadec 1989,  
Fig. 20, n°18

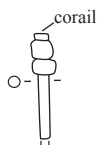

n°13 : D'après Lagadec 1989,  
Fig. 21, n°31

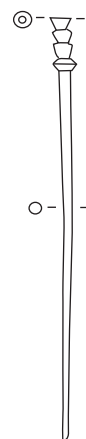

n°14 : 984.1277 ;  
D'après Lagadec 1989,  
Fig. 20, n°11



n°15 : 989.1281 ;  
D'après Lagadec 1989, Fig. 21, n°22

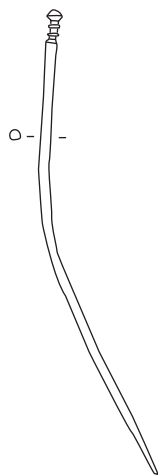

n°16 : 2F'-5g



n°17 : D'après Lagadec 1989,  
Fig. 21, n°22

n°1 à 17 : bronze



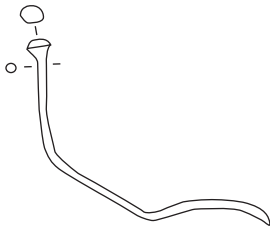

n°1 : 11G'-1g

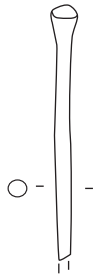

n°2 : D'après Lagadec 1989, Fig. 21, n°2

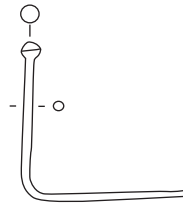

n°3 : C'7-19g

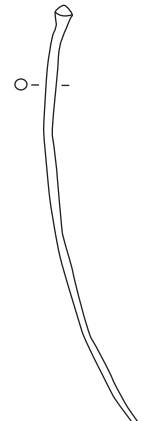

n°4 : 989.1235 ;  
D'après Lagadec 1989, Fig. 21, n°10

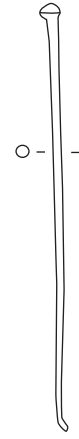

n°5 : A4-1g ;  
D'après Lagadec 1989, Fig. 20, n°19

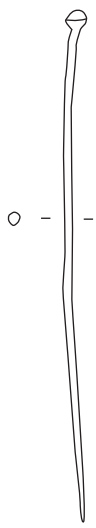

n°6 : ML 303.05 ;  
D'après Lagadec 1989, Fig. 39, n°6

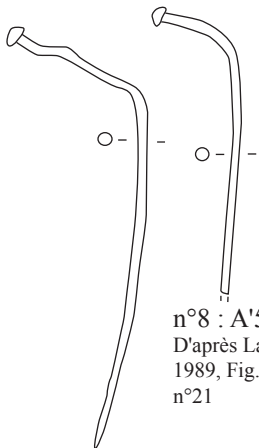

n°7 : D'après Lagadec 1989, Fig. 20, n°13

n°8 : A'5-16g ;  
D'après Lagadec 1989, Fig. 20, n°21

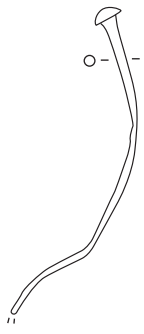

n°9 : 11G'-1g ;  
D'après Lagadec 1989, Fig. 20, n°3



n°10 : D'après Lagadec 1989, Fig. 21, n°26

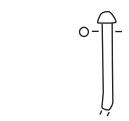

n°11 : C5-2g ; D'après Lagadec 1989, Fig. 21, n°30

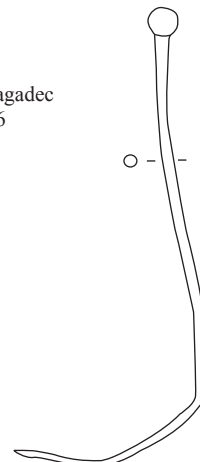

n°12 : 989.1280 ;  
D'après Lagadec 1989, Fig. 20, n°17

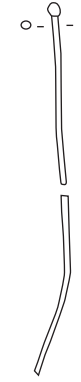

n°13 : 11F'-3g ;  
D'après Lagadec 1989, Fig. 21, n°28

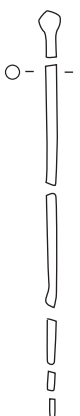

n°14 : F'1-4g ;  
D'après Lagadec 1989, Fig. 21, n°24

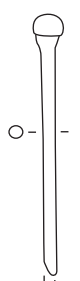

n°15 : D'après Lagadec 1989, Fig. 20, n°9

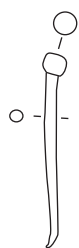

n°16 : B2-1g

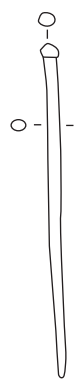

n°17 : F'1-4g

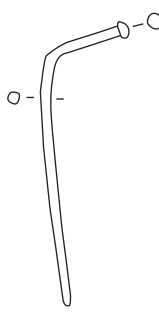

n°18 : 12B'-3f  
d'après Lagadec 1989, Fig. 20, n°20



n°19 : E'3-10g  
D'après Lagadec 1989, Fig. 21, n°26



n°20 : 8G'-4f ;  
D'après Lagadec 1989, Fig. 20, n°16

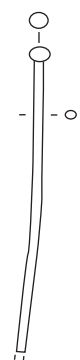

n°21 : 14K'-1f



n°22 : A'7-7g



n°23 : A'8-11g



n°24 : D'après Lagadec 1989, Fig. 20, n°8

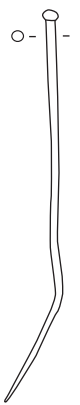

n°25 : 989.1279 ;  
D'après Lagadec 1989, Fig. 21, n°33

n°1 à 25 : bronze

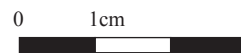

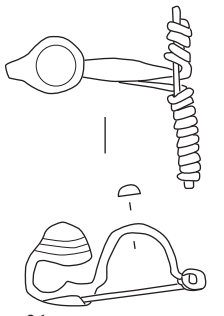

n°1 : D'après Lagadec 1989, Fig. 40, n°3

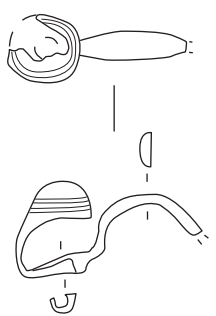

n°6 : G'3-6f

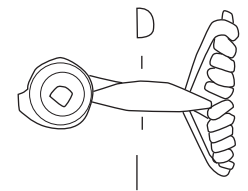

n°12 : ML 284.05 ;  
D'après Lagadec 1989,  
Fig. 38, n°4

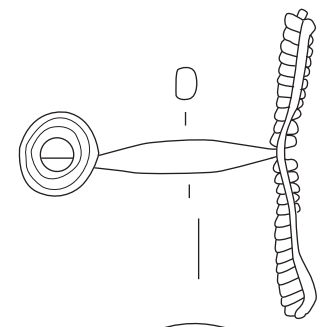

n°17 : 5A'-5g ; D'après Lagadec  
1989, Fig. 13, n°6

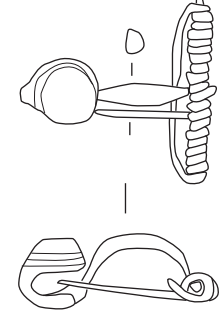

n°2 : ML 251.05 ;  
D'après Lagadec 1989, Fig. 38, n°5

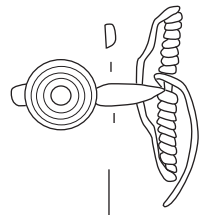

n°7 : D5-1f ;  
D'après Lagadec 1989,  
Fig. 13, n°15

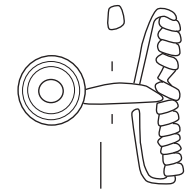

n°13 : C'2-5g ; D'après Lagadec 1989,  
Fig. 13, n°10

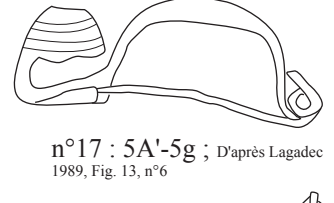

n°18 : 7F'-2f ;  
D'après Lagadec 1989,  
Fig. 13, n°8

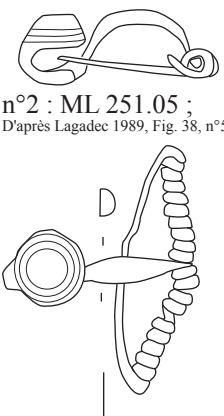

n°3 : E'4-2g ;  
D'après Lagadec 1989,  
Fig. 13, n°7



n°8 : 12G'-2f ;  
D'après Lagadec 1989,  
Fig. 18, n°58

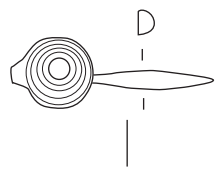

n°14 : D'après Lagadec 1989,  
Fig. 13, n°12

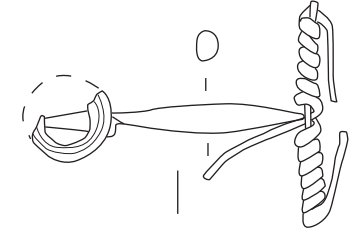

n°20 : F'2-8g  
D'après Lagadec 1989,  
Fig. 13, n°14

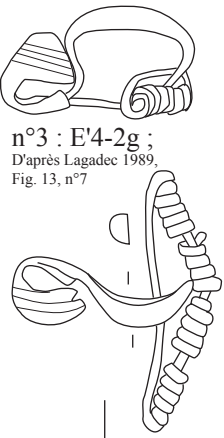

n°4 : 6A'-1f ;  
D'après Lagadec 1989,  
Fig. 13, n°9



n°9 : B'4-11g ;  
D'après Lagadec 1989, Fig. 18, n°55

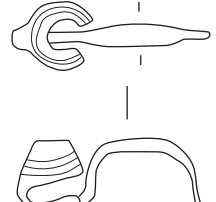

n°15 : D'après Lagadec 1989,  
Fig. 13, n°17

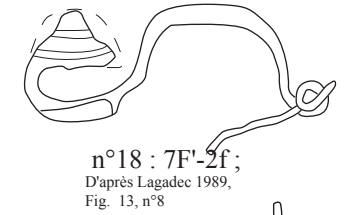

n°21 : 1B-4f  
D'après Lagadec 1989,  
Fig. 13, n°13

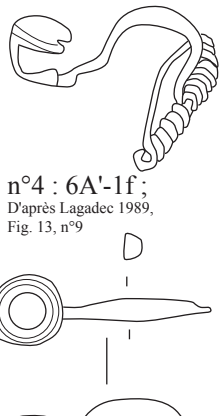

n°5 : 4D'-1f ;  
D'après Lagadec 1989, Fig. 13, n°11

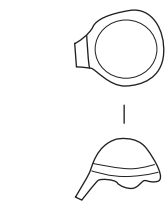

n°10 : C'1-4f ;  
D'après Lagadec 1989,  
Fig. 18, n°56

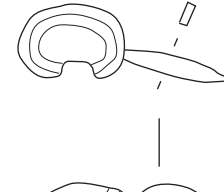

n°16 : D'6-11g  
D'après Lagadec 1989,  
Fig. 13, n°16

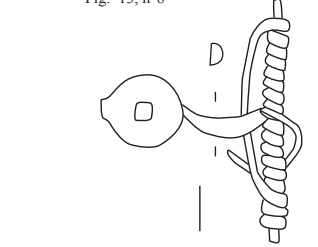

n°22 : C'8-10g

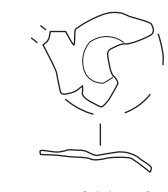

n°11 : 6E'-f

n°1 à 22 : bronze



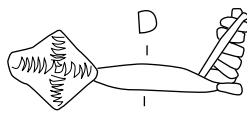

n°1 : ML 277.05 ;  
D'après Lagadec 1989,  
Fig. 38, n°7

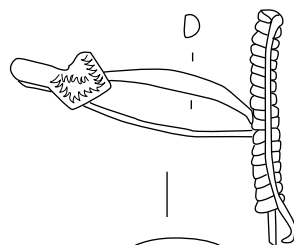

n°2 : 11D'-3g ; D'après Lagadec 1989,  
Fig. 14, n°19

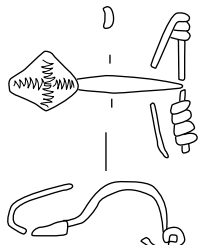

n°3 : 11C'-5g ;  
D'après Lagadec 1989,  
Fig. 14, n°23

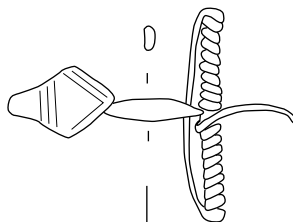

n°4 : 3D'-3f

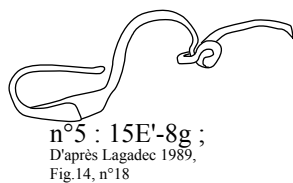

n°5 : 15E'-8g ;  
D'après Lagadec 1989,  
Fig.14, n°18

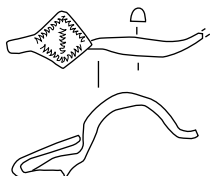

n°6 : 3B-1g ;  
D'après Lagadec 1989,  
Fig.14, n°20

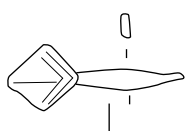

n°7 : D'après Lagadec 1989,  
Fig.14, n°22

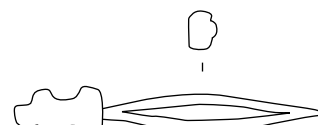

n°11 : D'après Lagadec 1989,  
Fig. 14, n°27

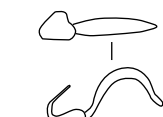
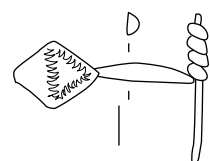

n°8 : 3D'-3f ;  
D'après Lagadec 1989,  
Fig.14, n°26

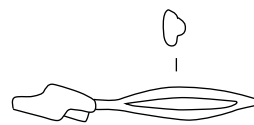

n°12 : 7E'-1f ;  
D'après Lagadec 1989,  
Fig. 14, n°18



n°9 : 1B-4f ;  
D'après Lagadec 1989,  
Fig.14, n°21



n°10 : 7A'-1F ;  
D'après Lagadec 1989,  
Fig. 14, n°28

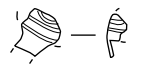
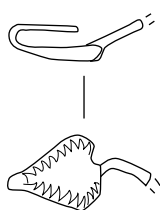

n°14 : C'5-11g

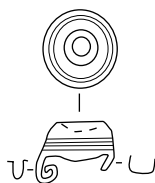

n°15 : 16A'-1e

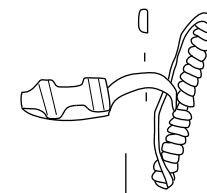

n°13 : 5A'-4g ;  
D'après Lagadec 1989,  
Fig. 14, n°24



n°1 à 15 : bronze

0 1cm



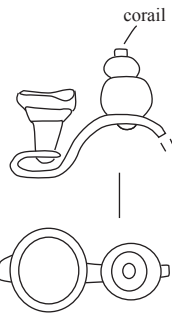

n°1 : D'2-6f ;  
D'après Lagadec 1989,  
Fig. 16, n°32

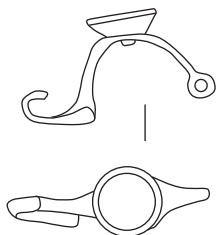

n°2 : D'après Lagadec 1989, Fig. 16, n°33

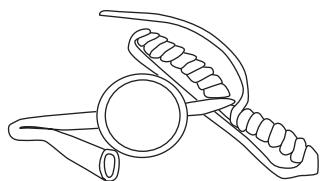

n°7 : B6-1g ;  
D'après Lagadec 1989, Fig. 16, n°34

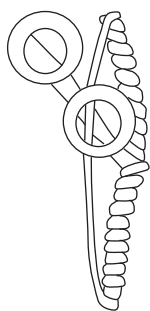

n°10 : 7E'-3g ; D'après Lagadec  
1989, Fig. 16, n°31



n°12 : D'après Lagadec 1989, Fig. 16, n°30

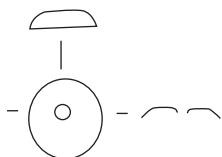

n°14 : 15J'-6f

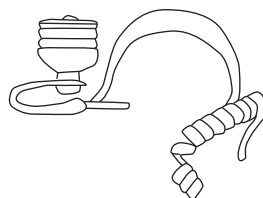
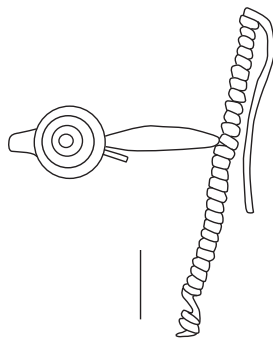

n°3 : D'4-4g ;  
D'après Lagadec 1989, Fig. 12, n°2

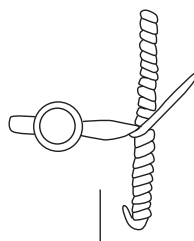

n°5 : D'après Lagadec 1989,  
Fig. 12, n°3

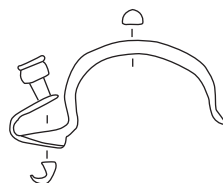

n°8 : B'5-8g  
D'après Lagadec 1989, Fig. 12, n°5

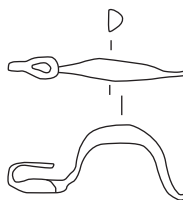

n°11 : ML 281.108 ;  
D'après Lagadec 1989,  
Fig. 38, n°6

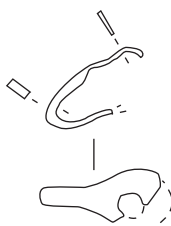

n°15 : C'8-7f

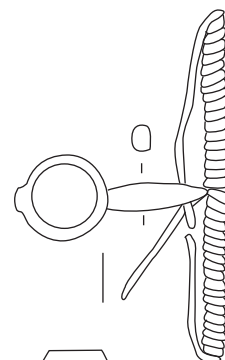

n°4 : A1-4g ;  
D'après Lagadec 1989,  
Fig. 12, n°1

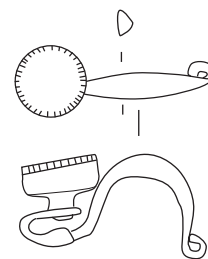

n°6 : G'5-2f ;  
D'après Lagadec 1989,  
Fig. 12, n°4

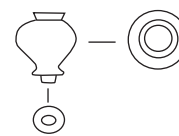

n°9 : B'9-10g



n°12 : B3-6f ;  
D'après Lagadec 1989,  
Fig. 18, n°59



n°13 : C'2-6g ;  
D'après Lagadec 1989,  
Fig. 18, n°60



n°16 : B'4-4f ;  
D'après Lagadec 1989,  
Fig. 18, n°57

n°1 à 16 : bronze

0 1cm

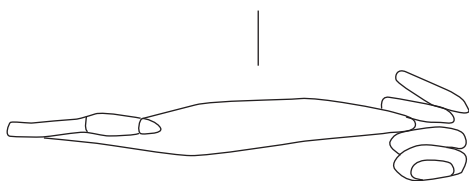
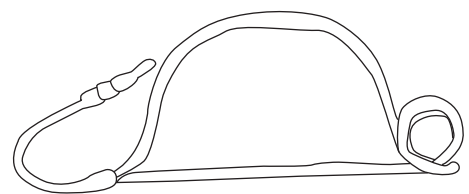

n°1 : D'après Lagadec 1989, Fig. 19, n°66

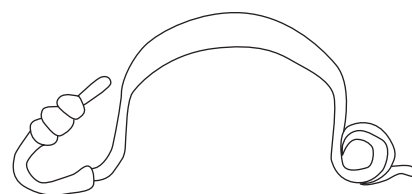

n°2 : D'après Lagadec 1989, Fig. 19, n°69

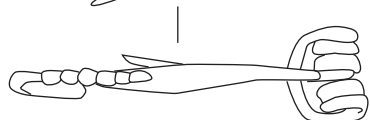
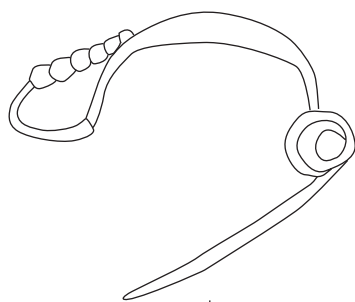

n°3 : D'après Lagadec 1989,  
Fig. 19, n°64

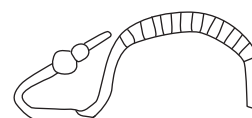

n°4 : A3-7g ;  
D'après Lagadec 1989, Fig. 19, n°70

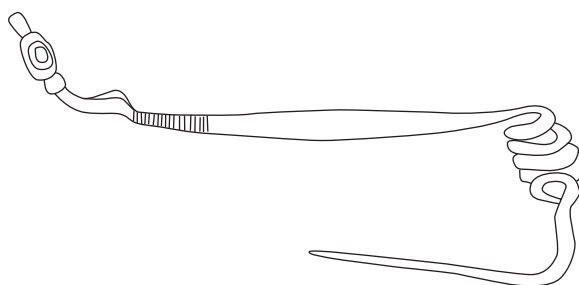

n°5 : D'après Lagadec 1989, Fig. 19, n°72

n°1 à 5 : bronze





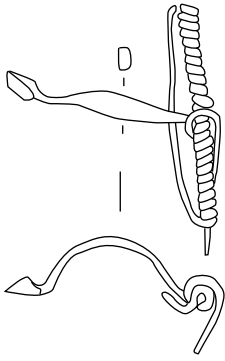

n°1 : A'2-7g ; D'après Lagadec 1989, Fig. 18, n°35

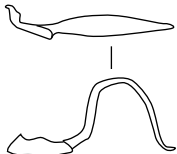

n°3 : C'3-6g ; D'après Lagadec 1989, Fig. 18, n°48

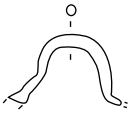

n°6 : 3H'-2f

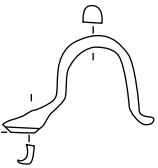

n°9 : D'9-9g

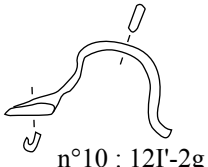

n°10 : 12I'-2g

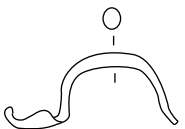

n°14 : D'après Lagadec 1989, Fig. 18, n°40

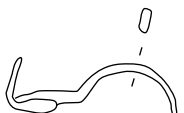

n°15 : D'après Lagadec 1989, Fig. 18, n°41

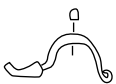

n°16 : B1-5g ; D'après Lagadec 1989, Fig. 18, n°43

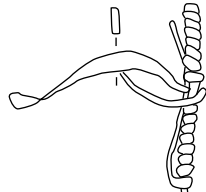

n°2 : D'après Lagadec 1989, Fig. 18, n°37

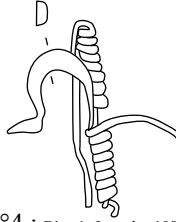

n°4 : D'après Lagadec 1989, Fig. 18, n°35

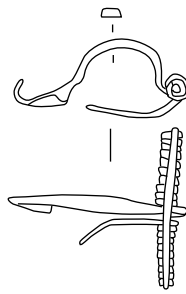

n°7 : D'après Lagadec 1989, Fig. 40, n°2

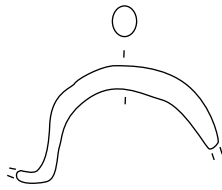

n°11 : A'9-16g

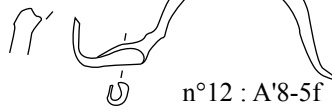

n°12 : A'8-5f

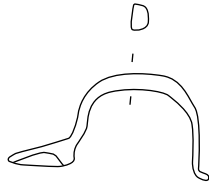

n°17 : D'après Lagadec 1989, Fig. 18, n°39

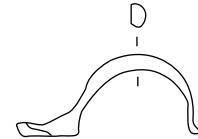

n°18 : D'après Lagadec 1989, Fig. 18, n°40

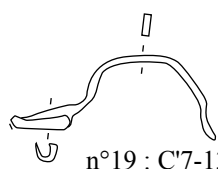

n°19 : C'7-13g

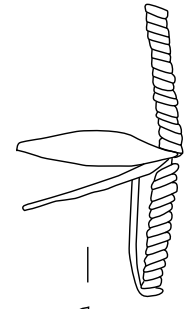

n°5 : 12G'-3f ; D'après Lagadec 1989, Fig. 18, n°61

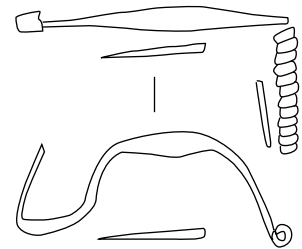

n°8 : 2F'-6g ; D'après Lagadec 1989, Fig. 18, n°44

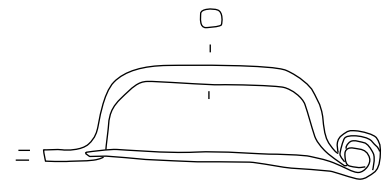

n°13 : D'après Lagadec 1989, Fig. 40, n°5

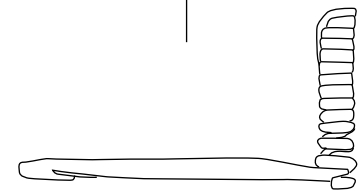

n°20 : 20F'-1z

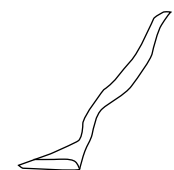

n°21 : D'après Lagadec 1989, Fig. 18, n°50

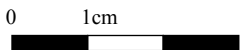

n°1 à 21 : bronze sauf n°13 : fer

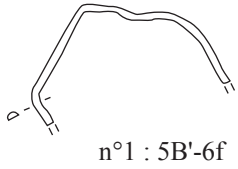

n°1 : 5B'-6f

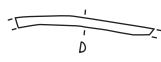

n°3 : A5-9g



n°5 : A'5-7g



n°7 : 16D'-1f

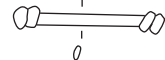

n°9 : D'6-12g

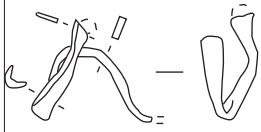

n°2 : 18H'-4g



n°4 : 11F'-2g

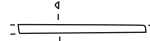

n°6 : D'4-5g



n°8 : B'5-1f



n°10 : D'9-8g



n°11 : 2C'-1f

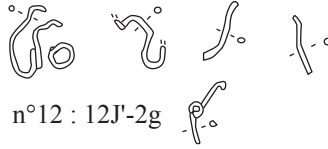

n°12 : 12J'-2g



n°13 : 1B'-3f

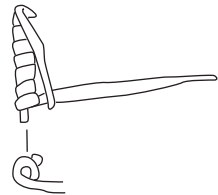

n°16 : 1C'-4f

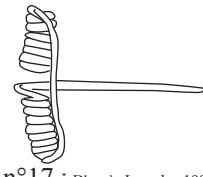

n°17 : D'après Lagadec 1989,  
Fig. 40, n°4

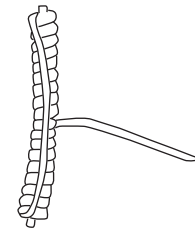

n°18 : A4-2g ; D'après Lagadec  
1989, Fig. 18, n°45



n°14 : 1B'-1f



n°15 : 9C'-5f



n°19 : 2C-1e

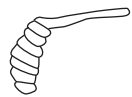

n°21 : H'3-2f

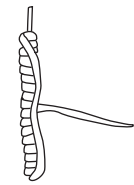

n°22 : C'3-5g ;  
D'après Lagadec 1989,  
Fig. 18, n°47

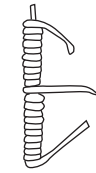

n°23 : D'5-6g ;  
D'après Lagadec 1989,  
Fig. 18, n°51



n°20 : 3F'-2f



n°27 : B'3-2f

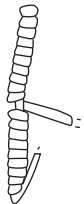

n°24 : 10D'-3f

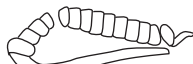

n°25 : 16H'-4f

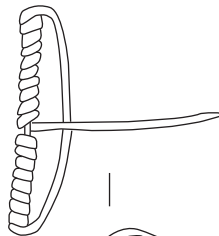

n°30 : 13D'-1f ;  
D'après Lagadec 1989,  
Fig. 18, n°46



n°26 : 2E'-1f

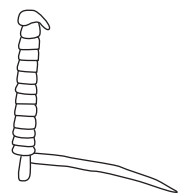

n°28 : B'1-3f

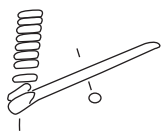

n°29 : 13B'-1f



n°31 :  
C'7-20g



n°32 : C'5-1f



n°33 : 3D'-2f

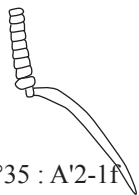

n°35 : A'2-1f



n°36 : E'5-4f

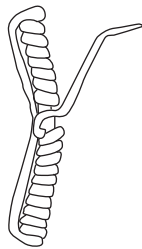

n°37 : D'après Lagadec 1989,  
Fig. 18, n°36

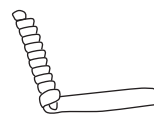

n°41 : B'2-1e



n°34 : 17K'-1f



n°38 : 5B'-5f



n°39 : 13E'-1f



n°40 : F'3-3f

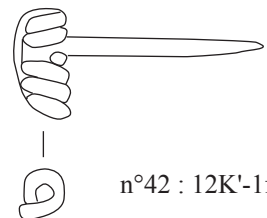

n°42 : 12K'-1f



n°1 à 42 : bronze

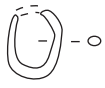

n°1 : H'2-2f

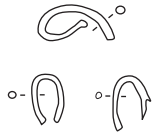

n°2 : D'après Lagadec 1989, Fig. 23



n°3 : D'après Lagadec 1989, Fig. 23



n°4 : D'après Lagadec 1989, Fig. 23



n°5 : A'9-14g



n°6 : D'après Lagadec 1989, Fig. 23

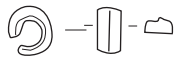

n°7 : D'9-11g



n°8 : D'après Lagadec 1989, Fig. 23



n°9 : D'après Lagadec 1989, Fig. 23



n°10 : C'8-12g

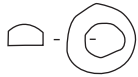

n°11 : C'7-9g

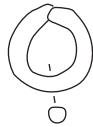

n°12 : C'8-7f



n°13 : D'après Lagadec 1989, Fig. 23



n°14 : D'après Lagadec 1989, Fig. 23



n°15 : 1B



n°16 : C'3-2f

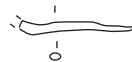

n°17 : A'5-17g

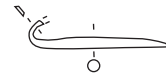

n°18 : D'8-13g

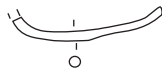

n°19 : 11C'-1f

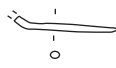

n°20 : 11G'-2g

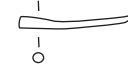

n°21 : D'6-9g

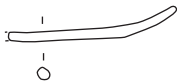

n°22 : 12H'-1f



n°23 : C'4-5g



n°24 : F'1-5g

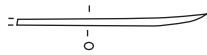

n°25 : 1A'-1f

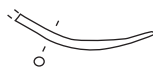

n°26 : B'8-9g



n°28 : 15E'-3f



n°27 : D'8-9g

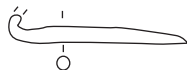

n°29 : 5C-2f



n°30 : 7B'-1f



n°31 : A5-9g

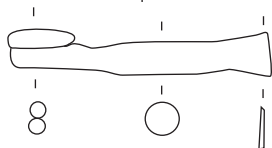

n°34 : F'8-1f

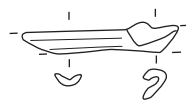

n°32 : A'8-6f



n°33 : 15H'

n°1 à 33 : bronze sauf n°34 : fer

0 1cm

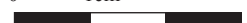

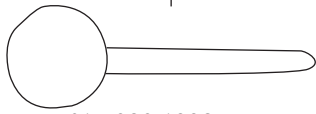
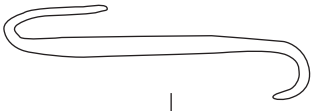

n°1 : 989.1228 ;  
D'après Lagadec 1989,  
Fig.35, n°1



n°2 : D'3-1f ;  
D'après Lagadec 1989,  
Fig.35, n°3

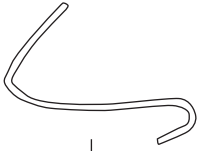

n°3 : 7B'-3g ;  
D'après Lagadec 1989,  
Fig.35, n°5



n°4 : 12H'-2g ;  
D'après Lagadec 1989,  
Fig.35, n°8

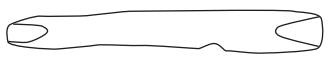

n°5 : D'après Lagadec 1989,  
Fig.35, n°9

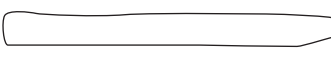

n°6 : C'7-21g



n°7 : 11C'-2g ;  
D'après Lagadec 1989, Fig.35, n°10

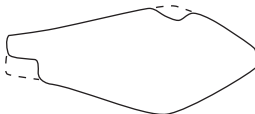

n°8 : 8G'-2f ;  
D'après Lagadec 1989,  
Fig.35, n°2

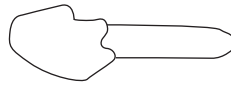

n°9 : A'1-g



n°10 : D'8-7g

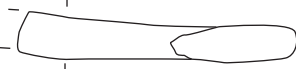

n°11 : F'2-7f



n°12 : 20G'-2e

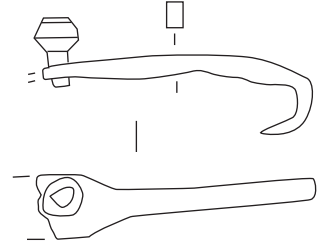

n°13 : 989.1228 ;  
D'après Lagadec 1989,  
Fig.35, n°4

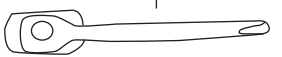
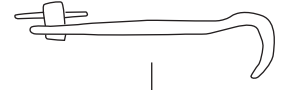

n°14 : 989.1290 ;  
D'après Lagadec 1989,  
Fig.35, n°6

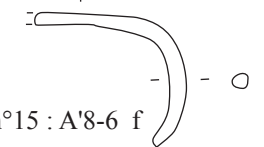

n°15 : A'8-6 f



n°16 : 14H'-3g

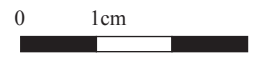

n°1 à 16 : fer sauf n°2

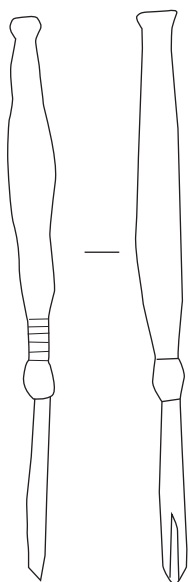

n°1 : D'après Lagadec 1989, Fig. 40, n°7

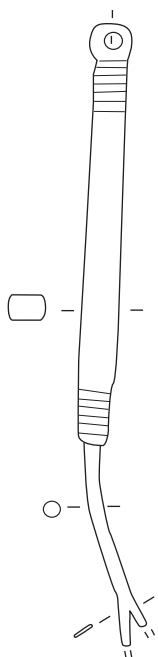

n°2 : 989.1218  
D'après Lagadec 1989, Fig. 36, n°1

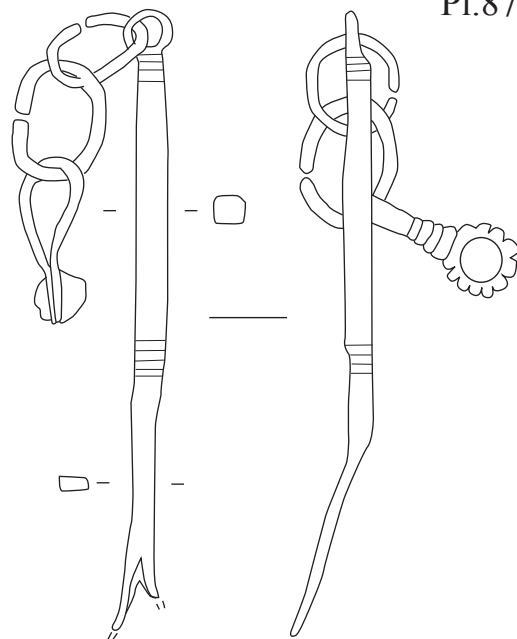

n°3 : D'après Lagadec 1989, Fig. 36, n°2

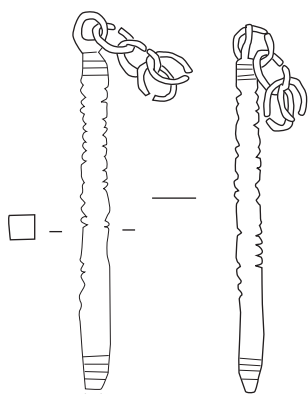

n°3 : D'après Lagadec 1989, Fig. 36, n°4

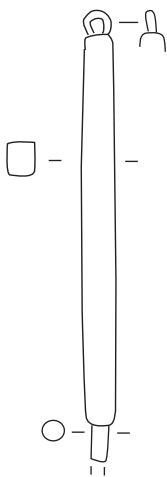

n°4 : 989.1221  
D'après Lagadec 1989, Fig. 36, n°3

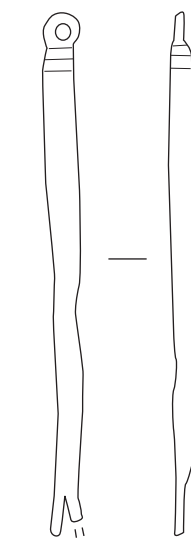

n°5 : D'après Lagadec 1989, Fig. 40, n°8

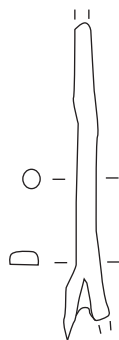

n°6 : 4F'-4f ;  
D'après Lagadec 1989,  
Fig. 36, n°9

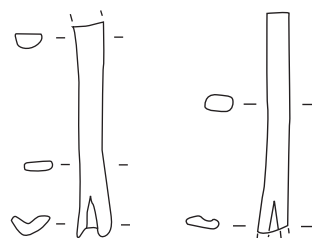

n°7 : 12H'-3g

n°8 : 12K'-2f



n°1 à 7 : fer

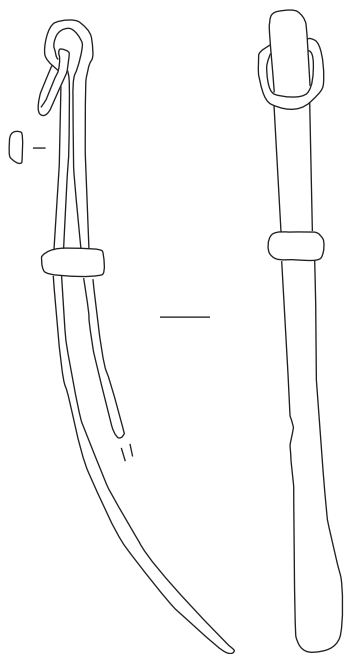

n°1 : D'après Lagadec 1989, Fig. 36, n°6

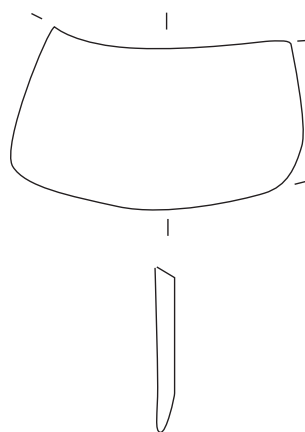

n°2 : C'8-6f

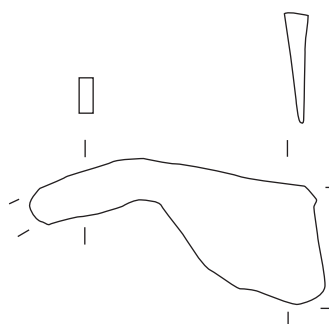

n°3 : D'après Lagadec 1989, Fig. 29, n°12

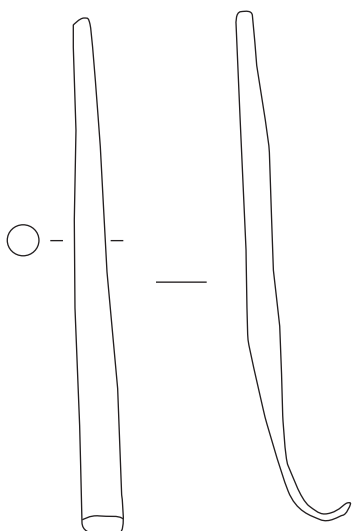

n°4 : D'après Lagadec 1989, Fig. 26, n°5

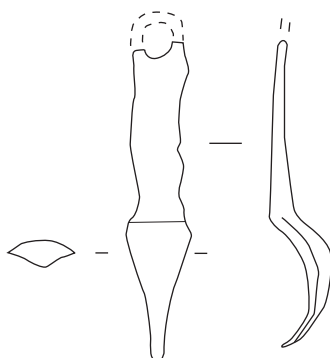

n°5 : 3B-4g ;  
D'après Lagadec 1989, Fig. 26, n°7

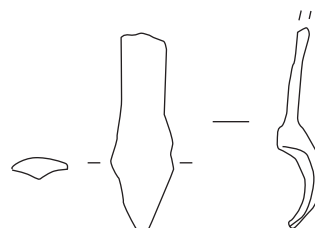

n°6 : 1B-4g ;  
D'après Lagadec 1989, Fig. 36, n°8

n°1 à 6 : fer

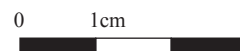

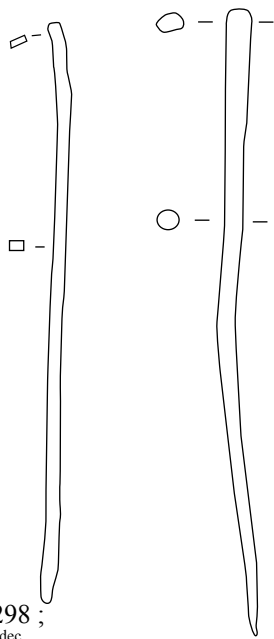

n°1 : A298 ;  
D'après Lagadec  
1989, Fig. 39, n°5

n°2 : ML 285.05 ;  
D'après Lagadec 1989,  
Fig. 39, n°4

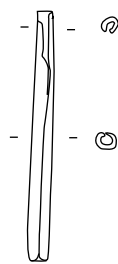

n°3 : 5K-1f



n°4 : 14I'-2g



n°5 : 8F'-2f

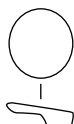

n°7 : 7A'-2g  
brut de fonte

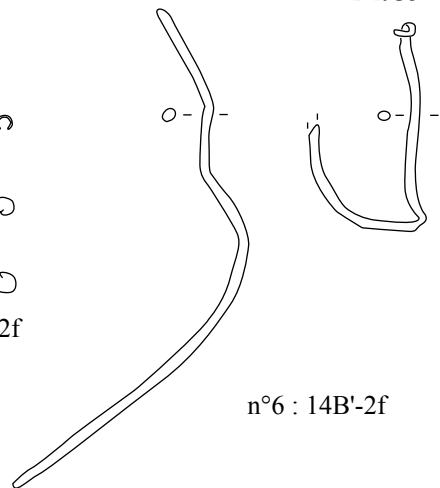

n°6 : 14B'-2f

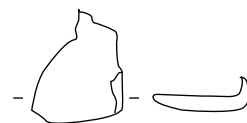

brut de fonte

n°8 : 11D'-2f

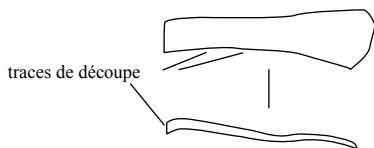

n°9 : 8C'-3f

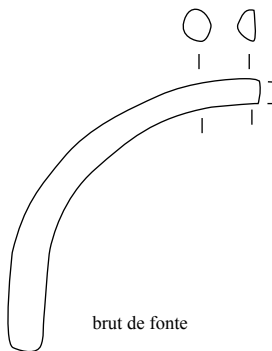

n°11 : G'3-6f ;  
D'après Lagadec 1989,  
Fig.24, n°4

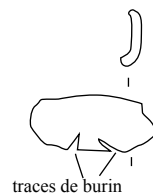

n°12 : E'6-4g

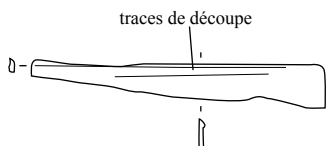

n°10 : 3D'-4f

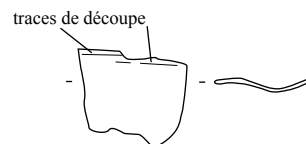

n°13 : 12F'-5f

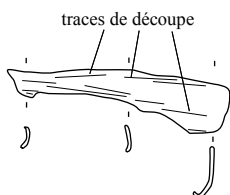

n°14 : 3G'-3f



n°15 : 18I'-2f

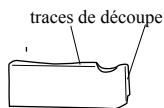

n°16 : 7D'-3f

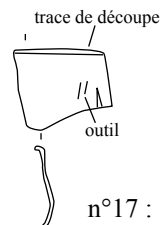

n°17 : 10G'-5g

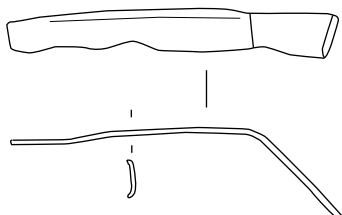

n°18 : A'5-8g

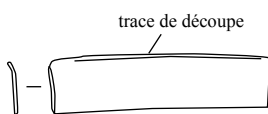

n°19 : E'6-5g

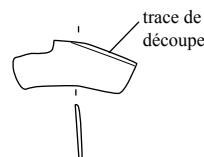

n°20 : 18H'-1f

n°1 à 20 : bronze

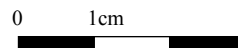

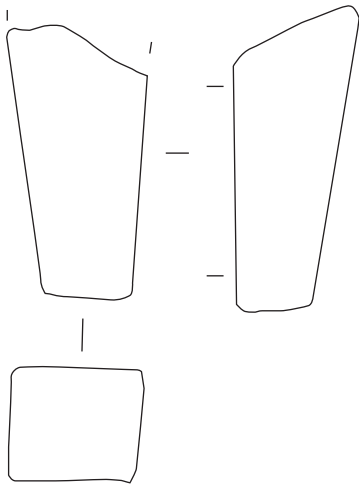

n°1 : A6-4G

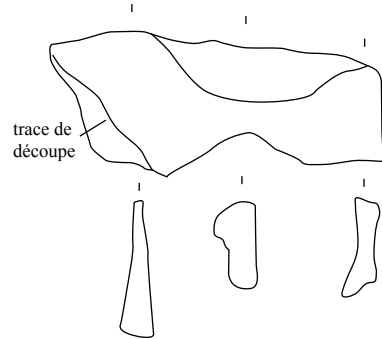

n°2 : C'7-14g

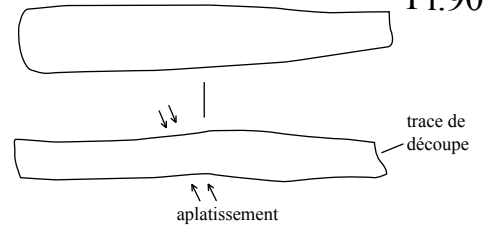

n°3 : C'8-1f

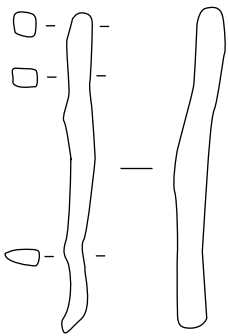

n°4 : C'6-3g

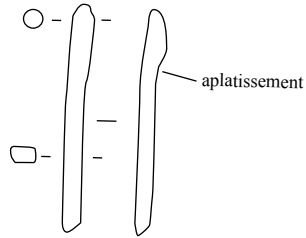

n°5 : C'6-1g

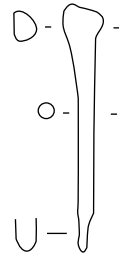

n°6 : A5-10g

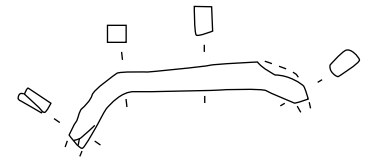

n°7 : 17E'-2f

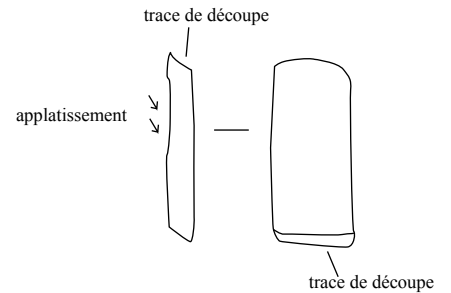

n°8 : D6-1g

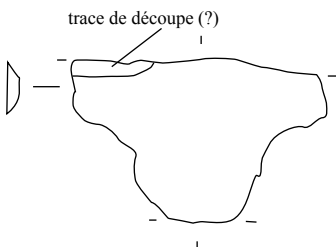

n°9 : C'4-2f

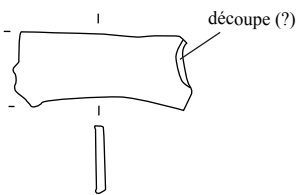

n°10 : B1-2f

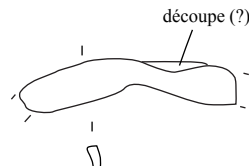

n°11 : 7E'-1f

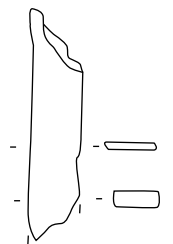

n°12 : 4A'-4f

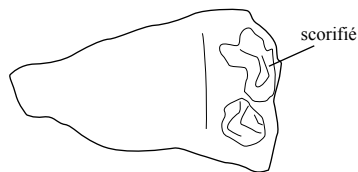

n°14 : 15E'-1f

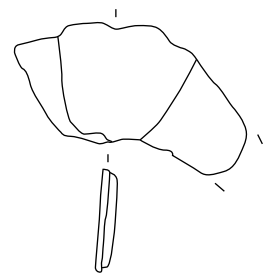

n°15 : A'9-13g

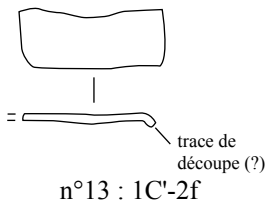

n°13 : 1C'-2f

n°1 à 15 : fer

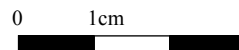



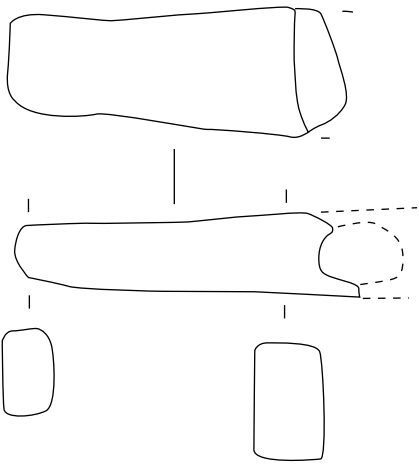

n°1 : 9A'-1e

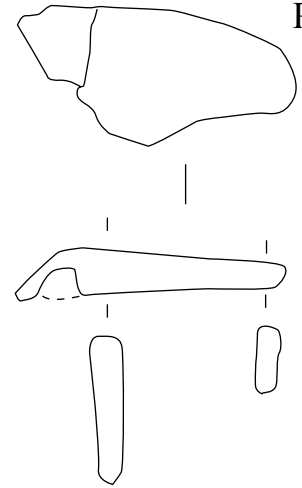

n°2 : 18J'-2e

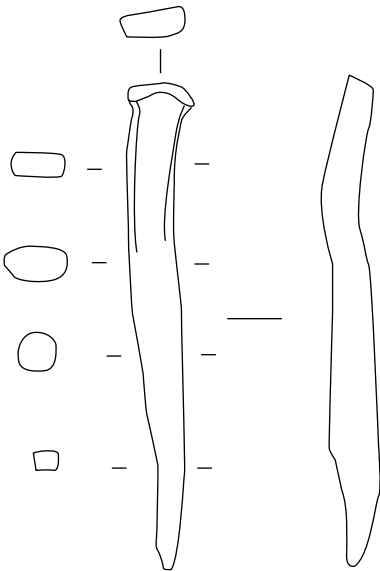

n°3 : B'7-3f

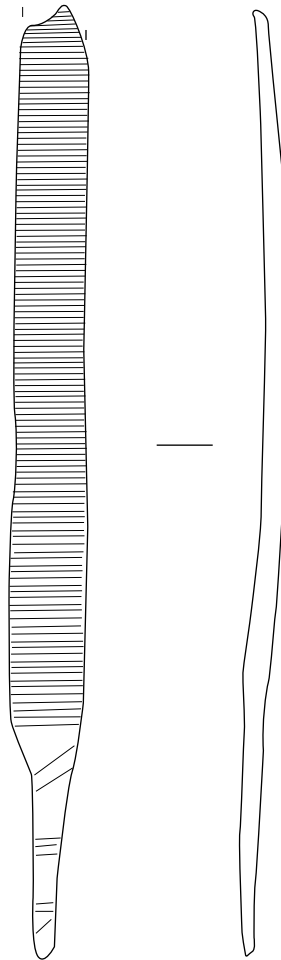

n°4 : D'après Lagadec 1999, Fig. 13, n°1

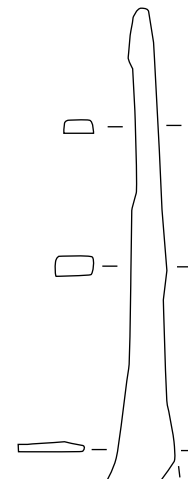

n°5 : F'1-1f ;  
D'après Lagadec 1989, Fig. 29 n°8

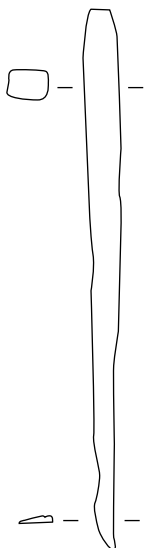

n°6 : D'après Lagadec 1989, Fig. 29, n°7

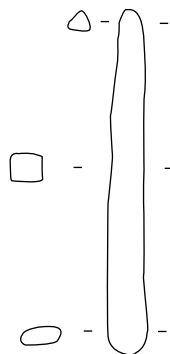

n°7 : 12H'-4g



n°8 : 13J'-3f

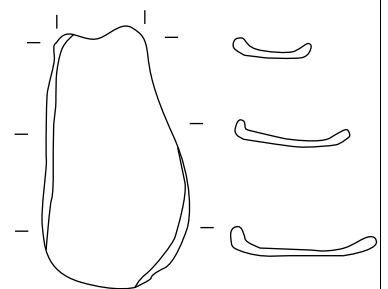

n°9 : 1C'-1f

n°1 à 9 : fer

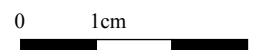

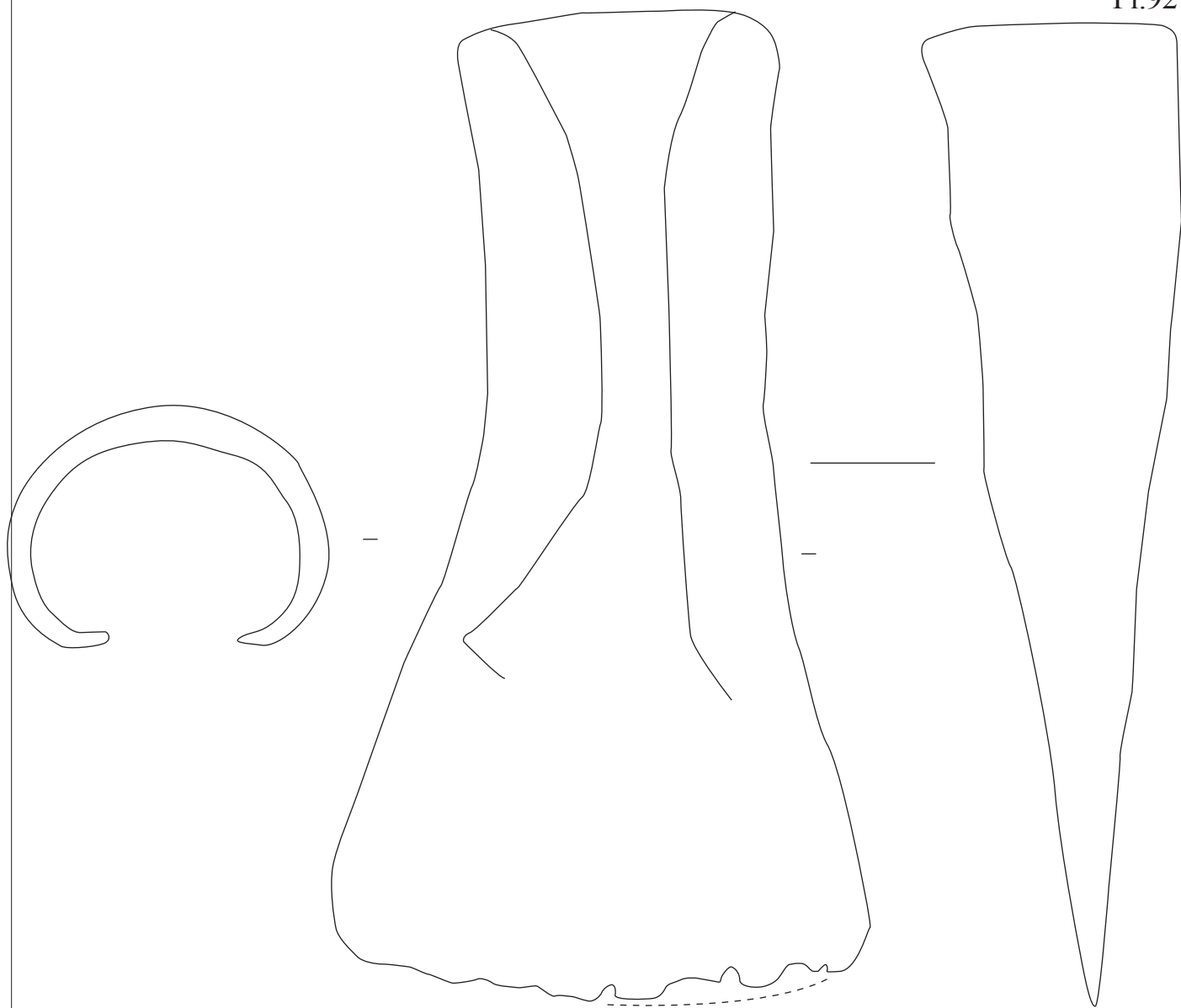

n°1 : D'après Lagadec 1989, Fig. 37, n°1

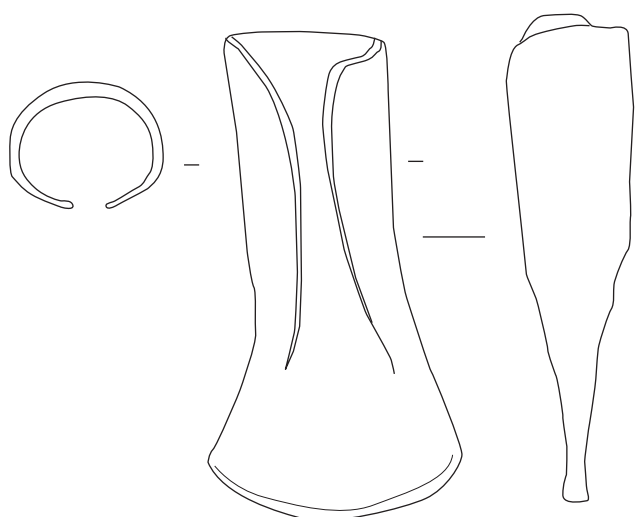

n°2 : Sondage 3 ; D'après Lagadec 1989, Fig. 29, n°1

n°3 : 12F'-6g ;  
D'après Lagadec 1989, Fig. 29, n°13

n°4 : 18D'-1f ;  
D'après Lagadec 1989, Fig. 28, n°4

n°1 à 4 : fer

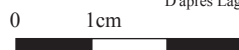

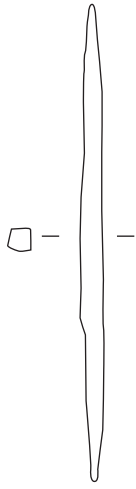

n°1 : D'après Lagadec 1989, Fig. 29, n°9

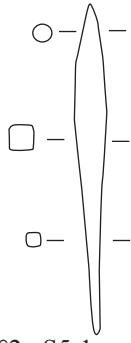

n°2 : S5-1 ; D'après Lagadec 1989, Fig. 29, n°11

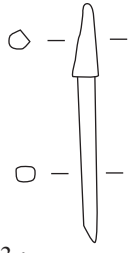

n°3 : D'après Lagadec 1989, Fig. 29, n°14

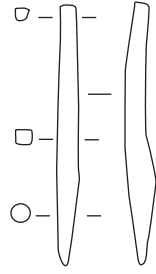

n°4 : 7B'-2f

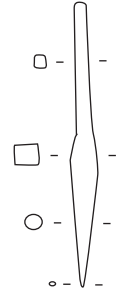

n°5 : 14C'-3f

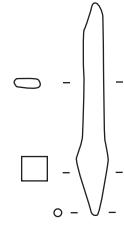

n°6 : 9B'-2g

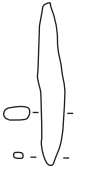

n°7 : 4A'-3f

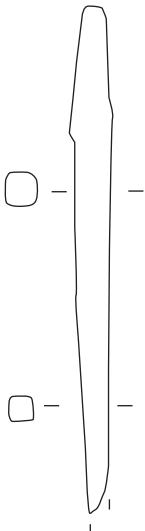

n°9 : D'après Lagadec 1989, Fig. 29, n°5



n°10 : 3H'-1f

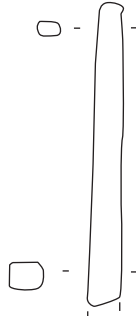

n°11 : 12J'-1g

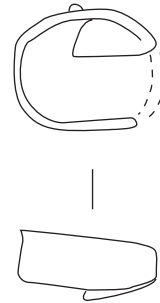

n°12 : 14H'-1

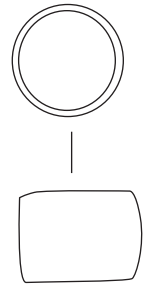

n°13 : B5-3f ; D'après Lagadec 1989, Fig. 23, n°25

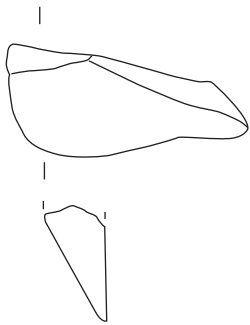

n°14 : 13G'-2g

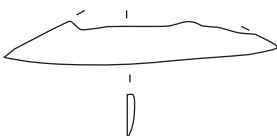

n°15 : 12H'-2g

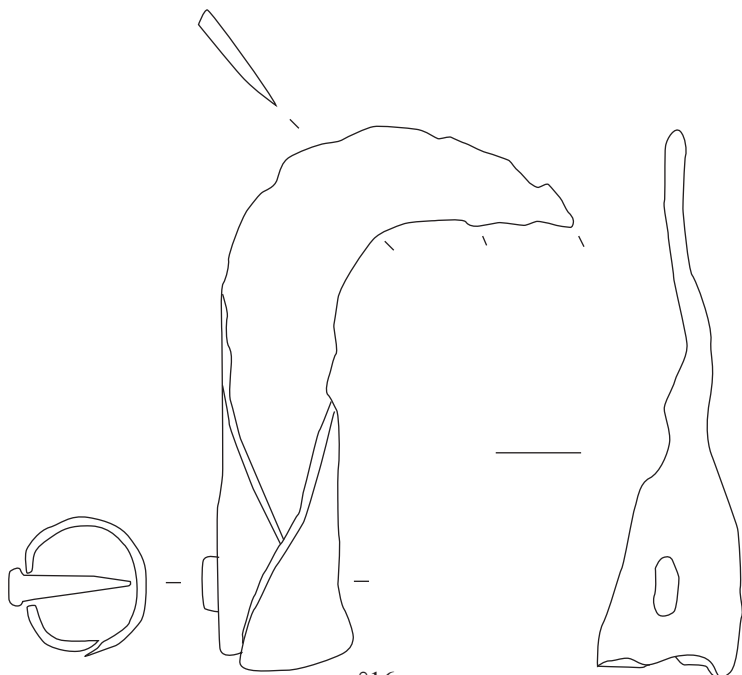

n°16 : D'après Lagadec 1989, Fig. 28, n°2

n°1 à 16 : fer

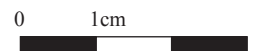

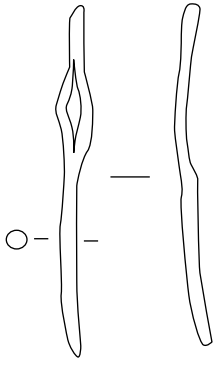

n°1 : D'après Lagadec 1989, Fig. 22, n°13

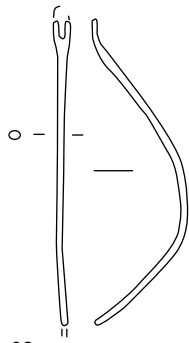

n°2 : D'après Lagadec 1989, Fig. 22, n°11

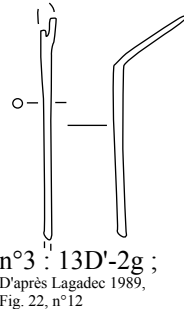

n°3 : 13D'-2g ;  
D'après Lagadec 1989, Fig. 22, n°12

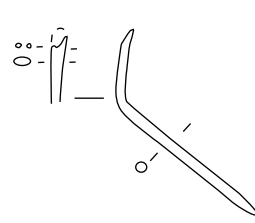

n°4 : 10E'-3f

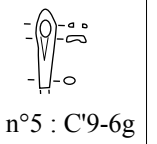

n°5 : C'9-6g

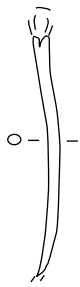

n°6 : D'après Lagadec 1989, Fig. 22, n°9

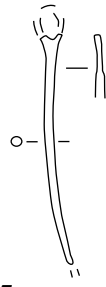

n°7 : D'après Lagadec 1989, Fig. 22, n°10



n°8 : 9D'-3f

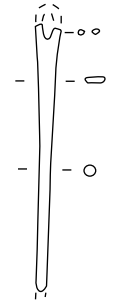

n°9 : D'7-3f

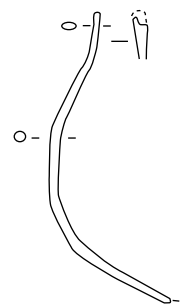

n°10 : 12F'-3f

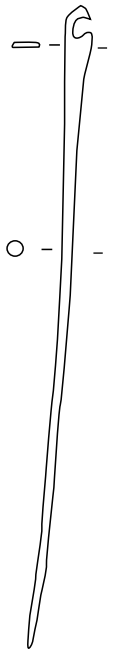

n°11 : ML 5009.05 ;  
D'après Lagadec 1989, Fig. 39, n°7

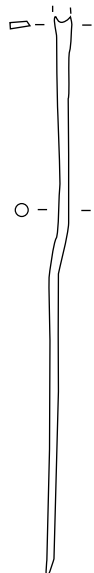

n°12 : A299 ;  
D'après Lagadec 1989, Fig. 39, n°8



n°13 : ML 304.05 ;  
D'après Lagadec 1989, Fig. 39, n°9

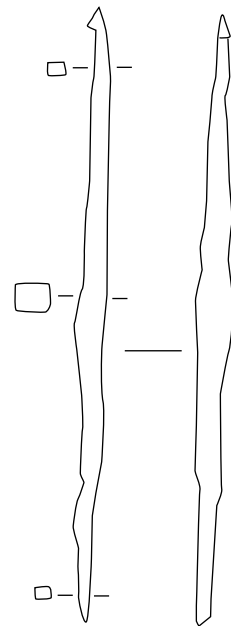

n°14 : 989.1258 ;  
D'après Lagadec 1989, Fig. 28, n°6

n°1 à 13 : bronze sauf n°1-14 : fer

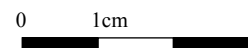

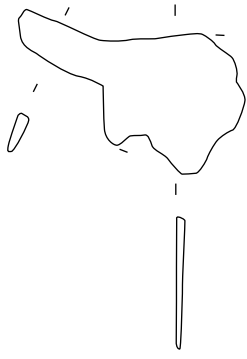

n°1 : 5C-3g

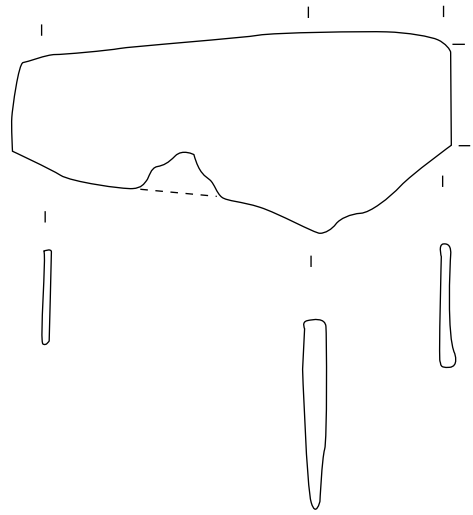

n°2 : B'5-4g

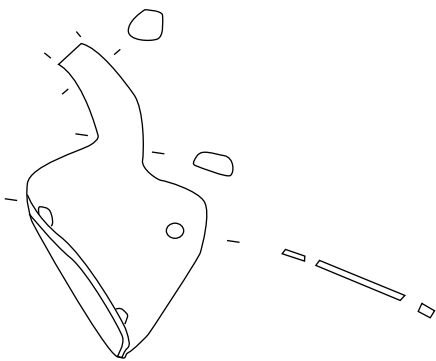

n°4 : D'8-1e

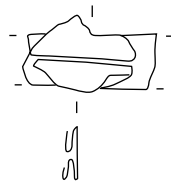

n°5 : B'7-1f

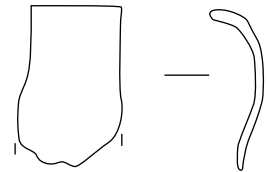

n°6 : A'6-8g

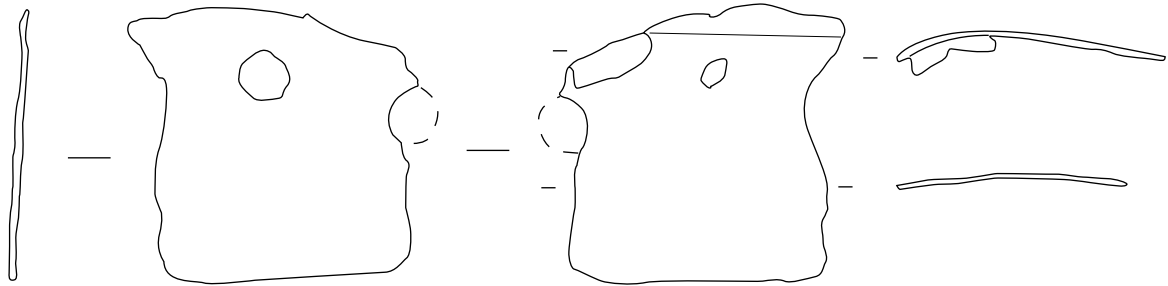

n°7 : 7G'-2f

n°1 à 7 : fer sauf n°5 : bronze

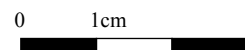

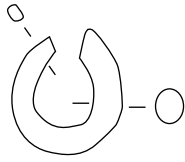

n°1 : D'après Lagadec 1989, Fig. 23, n°26



n°2 : D'après Lagadec 1989, Fig. 23, n°8

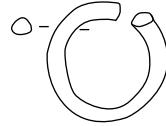

n°3 : D'après Lagadec 1989, Fig. 23, n°7

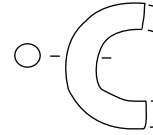

n°4 : D'3-9g ;  
D'après Lagadec 1989, Fig. 23, n°5

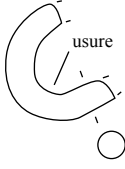

n°5 : D'3-9g

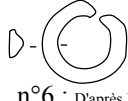

n°6 : D'après Lagadec 1989, Fig. 23, n°10

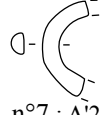

n°7 : A'2-6g ;  
D'après Lagadec 1989, Fig. 23, n°11

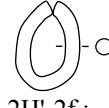

n°8 : 2H'-2f ;  
D'après Lagadec 1989, Fig. 23, n°12

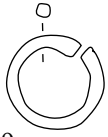

n°9 : D'après Lagadec 1989, Fig. 23, n°9

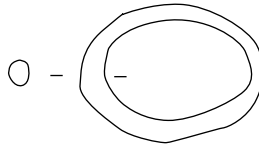

n°10 : ML301.05 ;  
D'après Lagadec 1989, Fig. 38, n°2

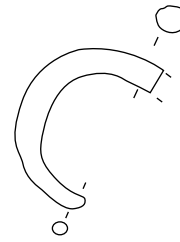

n°11 : 14J'-4f

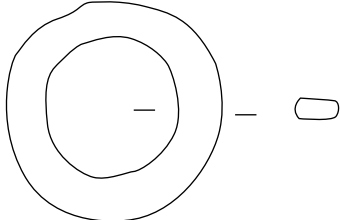

n°12 : 4B'-1f ;  
D'après Lagadec 1989, Fig. 23, n°21

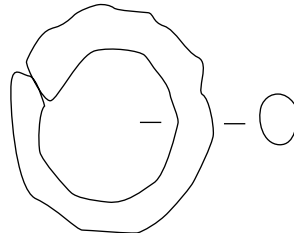

n°13 : 6I'-1f ;  
D'après Lagadec 1989, Fig. 23, n°22

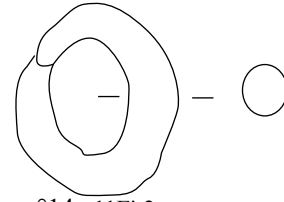

n°14 : 11E'-2g ;  
D'après Lagadec 1989, Fig. 23, n°23

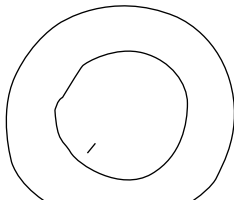

n°15 : 4B'-1f

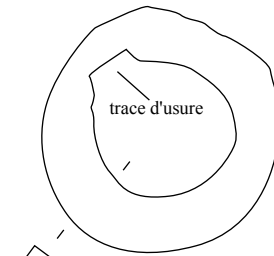

n°16 : 14J'-7f

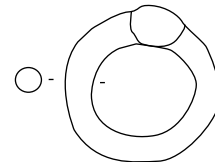

n°17 : D'après Lagadec 1989, Fig. 23, n°4

n°1 à 17: bronze sauf n°13-14 : fer

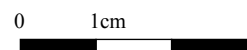

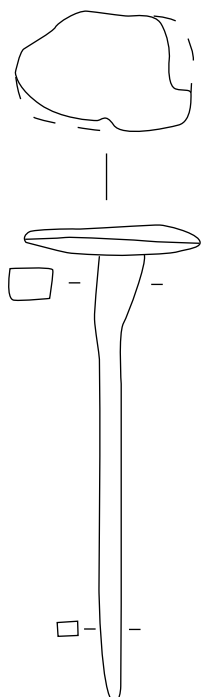

n°1 : 8H'-4f

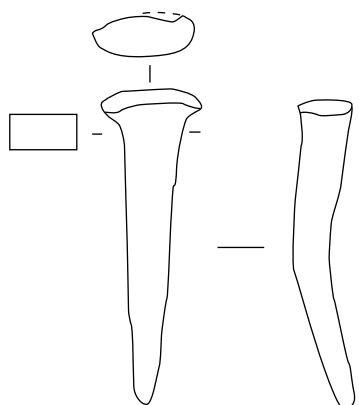

n°2 : 11D'-1f

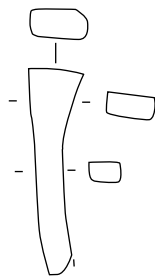

n°3 : 15J'-8f

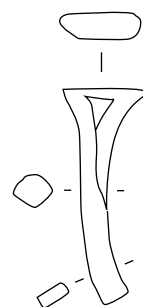

n°4 : 2D'-1f

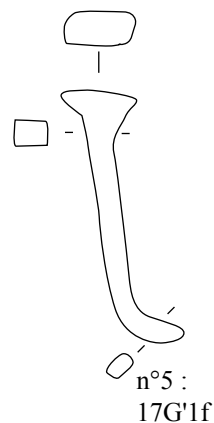

n°5 : 17G'1f

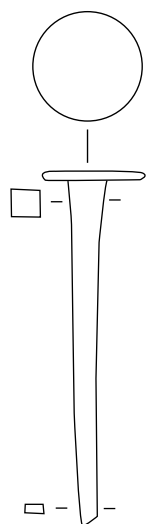

n°6 : 8H'-3f

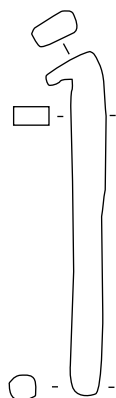

n°7 : 9H'-4f

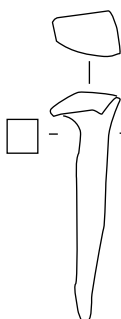

n°8 : 12A'-1g



n°9 : 10B'-2f



n°10 : 17J'-6f



n°11 : B'6-5g

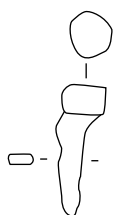

n°12 : B'8-10g



n°13 : S11



n°14 : 2G'-1f

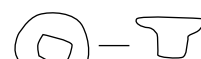

n°15 : F'9-1e

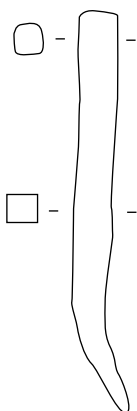

n°16 : 3C-2g

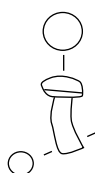

n°17 : A'8-9g



n°18 : 12I'-1g

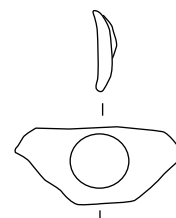

n°20 : 2F'-4g



n°19 : 2E'-4f



n°21 : A'9-12g

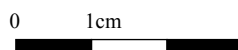

n°1 à 12-16 : fer sinon bronze

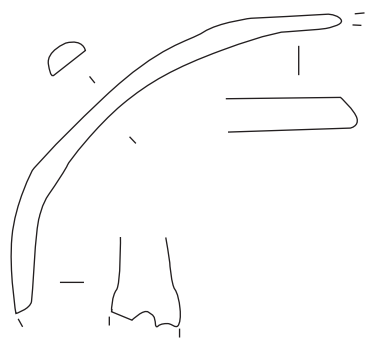

n°1 : B'9-9g

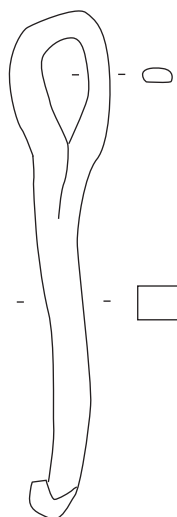

n°2 : A'9-7g

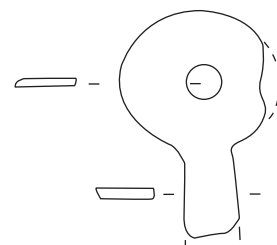

n°3 : E'7-1f

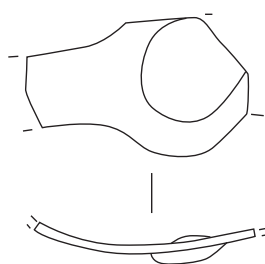

n°5 : C'9-1f

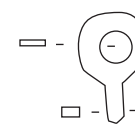

n°4 : D'7-1f

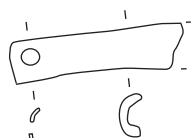

n°6 : A'7-5g

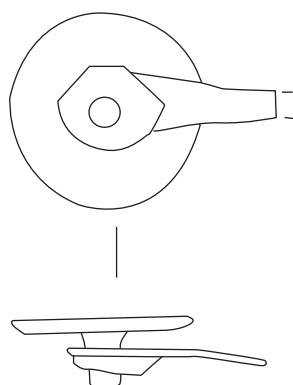

n°7 : B'7-éboulis de la coupe

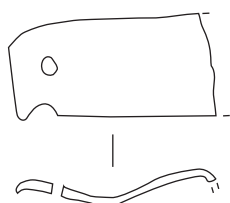

n°8 : A'3-7g

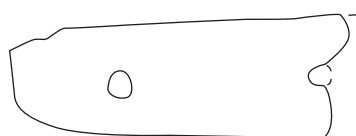

n°9 : A'3-4g

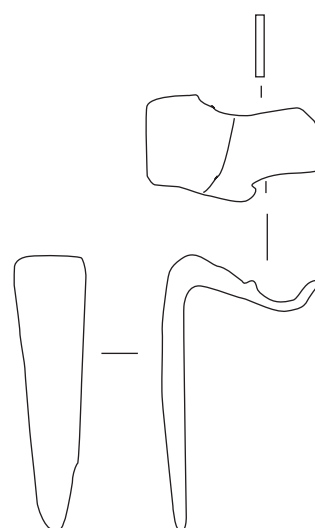

n°10 : C4-2f

n°1 à 10 : fer sauf n°3-4 : bronze

0 1cm





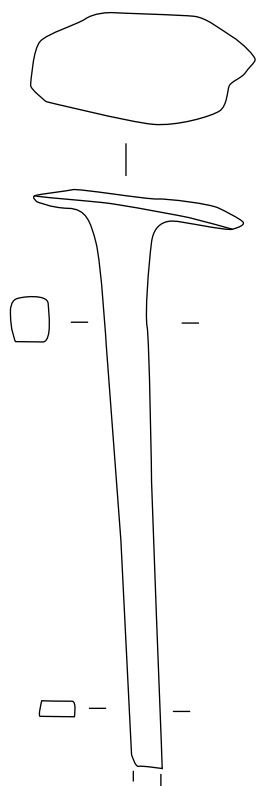

n°1 : D'après Lagadec1989, Fig. 30, n°1

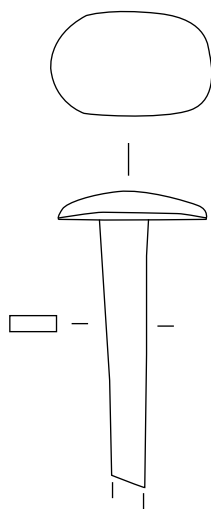

n°2 : 14H'-2g ;  
D'après Lagadec1989,  
Fig. 30, n°2

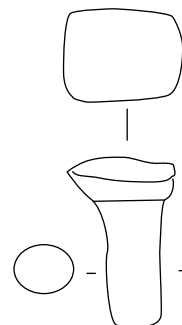

n°3 : Sans numéro-couche g

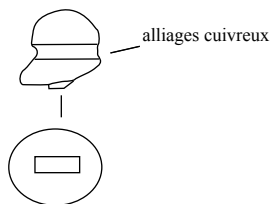

n°4 : B'9-5f

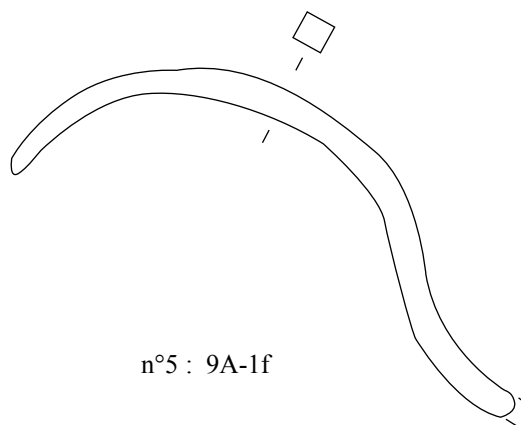

n°5 : 9A-1f

n°1 à 5 : fer

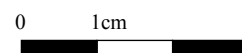

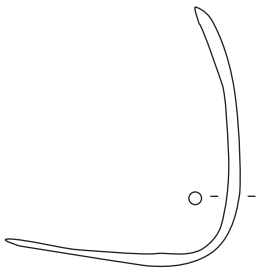

n°1 : D'après Lagadec 1989, Fig. 20, n°6



n°2 : A4-1f ;  
D'après Lagadec 1989, Fig. 21, n°25



n°3 : 8C'-4f ;  
D'après Lagadec 1989, Fig. 20, n°4



n°4 : B'5-6g ;  
D'après Lagadec 1989, Fig. 20, n°7

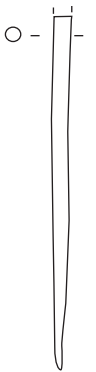

n°5 : B'9-7g

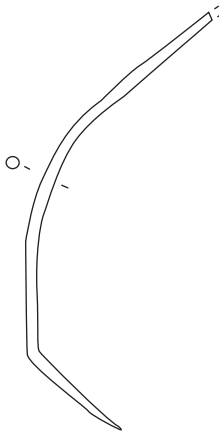

n°6 : 6C'-3f

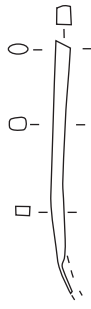

n°7 : F'1-2f

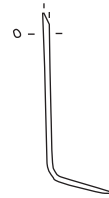

n°8 : D'après Lagadec 1989, Fig. 21, n°29

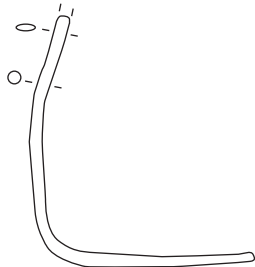

n°9 : 5B'-4f

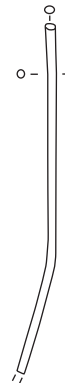

n°10 : 11F'-3g

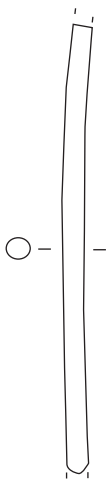

n°11 :  
11B'-1g

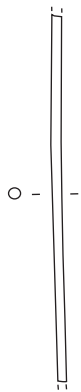

n°12 :  
E'1-8g

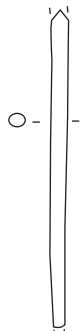

n°13 :  
B'7-7g

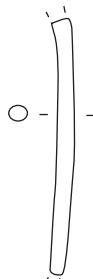

n°14 :  
D'8-8g

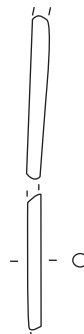

n°15 :  
14D'-1f

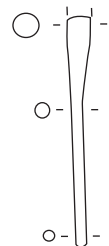

n°16 :  
D'8-5f

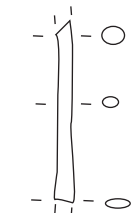

n°17 : B5-6g

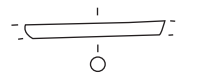

n°18 : 17E'-1f

n°1 à 18 : bronze

0 1cm





n°1 : 15H'



n°2 : B'8-18g

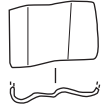

n°3 : 13H'-2g



n°4 : A3-5g

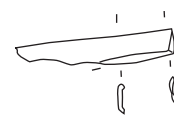

n°5 : C'5-10g

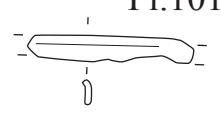

n°6 : 16I'-1g



n°7 : C3-3g

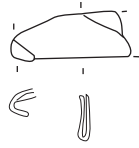

n°8 : 17F'-1f

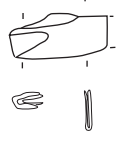

n°9 : 1A'-4g

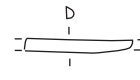

n°10 : E'7-2g



n°11 : 16H'-1g

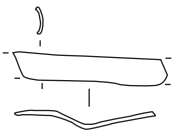

n°12 : C3-4g



n°13 : 1A'-5g

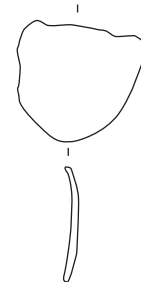

n°14 : D'3-2f

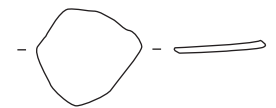

n°15 : G'2-2f

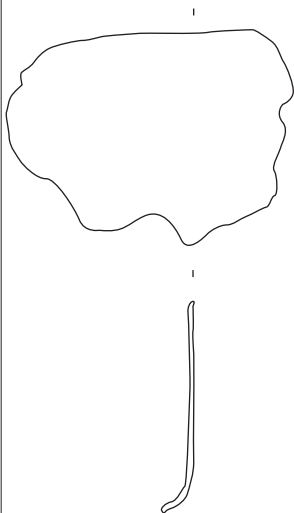

n°16 : 3D'-1f



n°17 : 10E'-1f

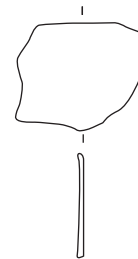
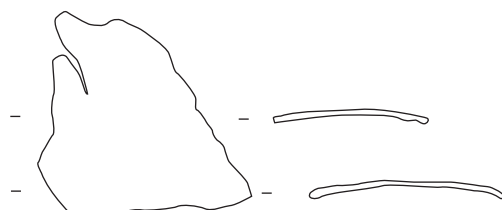

n°18 : 4B'-2g

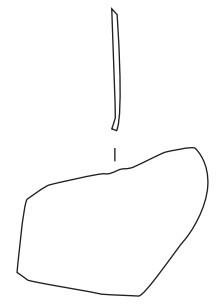

n°19 : B4-4g

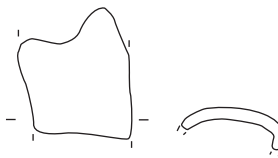

n°20 : B'8-12g

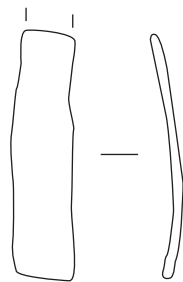

n°21 : D'9-5f

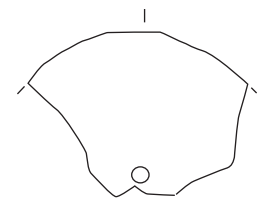

n°22 : 14J'-4e

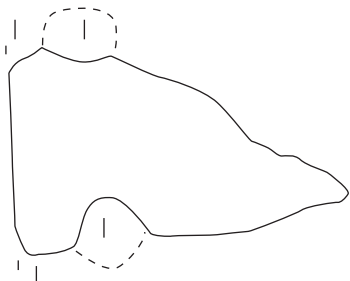

n°23 : 2A-5g

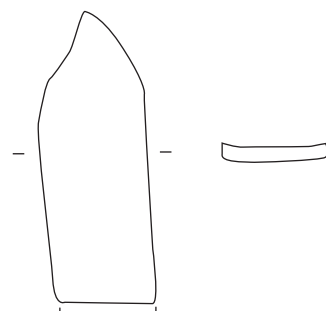

n°24 : 10F'-1f

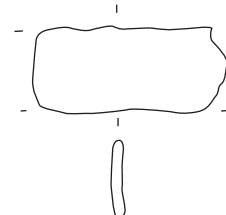

n°25 : 2E'-6f

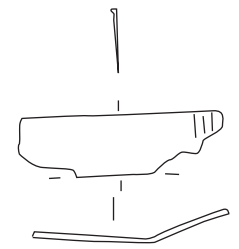

n°26 : 11F'-1g

n°1 à 26 : bronze

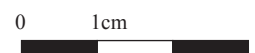

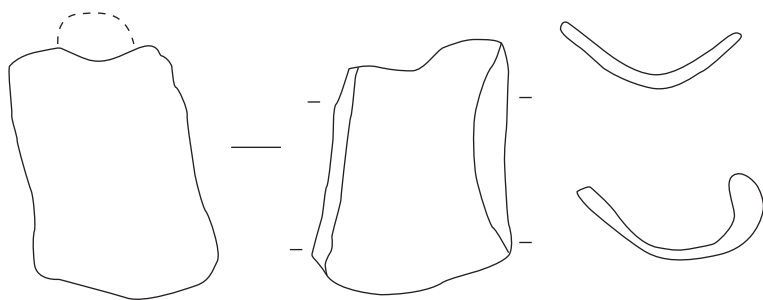

n°1 : 2C-3g

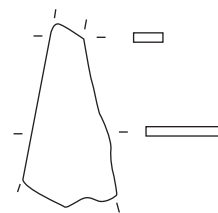

n°2 : 8B'-1f

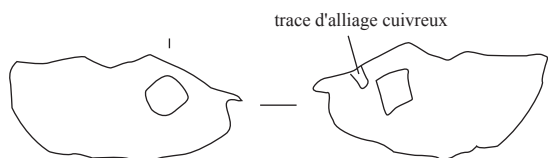

n°3 : 1C'-1f

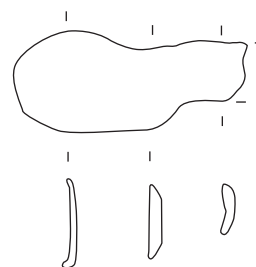

n°4 : A'2-3f

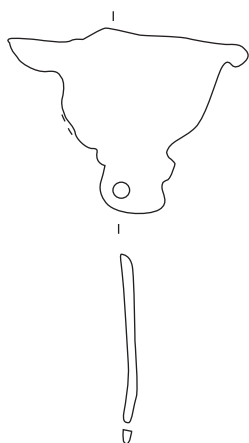

n°5 : A'4-1f

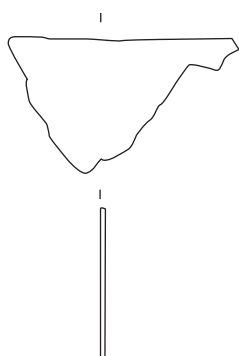

n°6 : 4A-2g

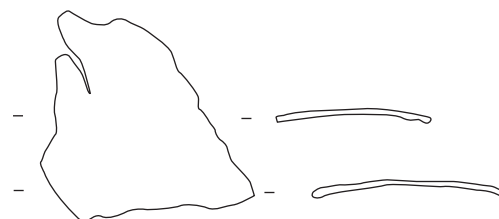

n°7 : 10E'-1f

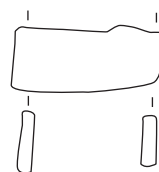

n°8 : D'3-5f

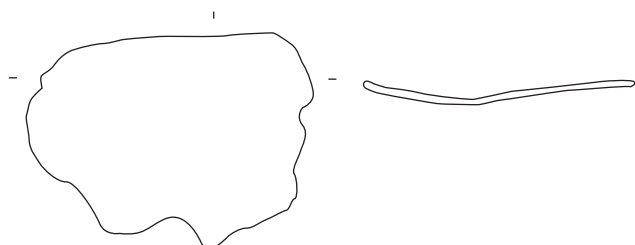

n°9 : 3D'-1f

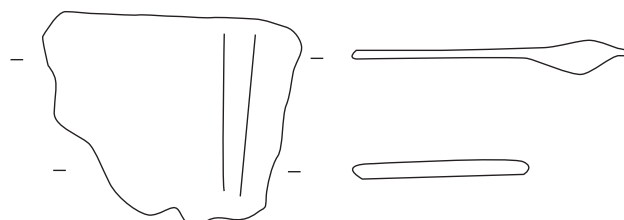

n°10 : D'8-3f

n°1 à 10 : fer





n°1 : 6A-2g



n°2 : B'4-7g

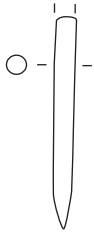

n°3 : 13D'-2g



n°4 : B'6-6g

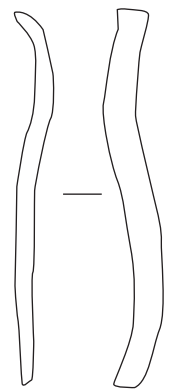

n°5 : B'1-5g

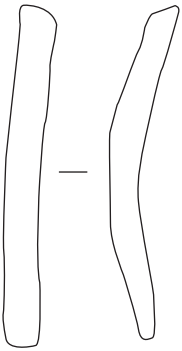

n°6 : B1-3f

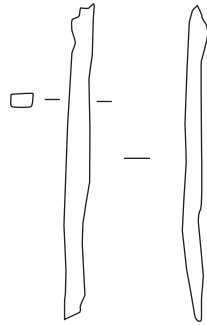

n°7 : D'après Lagadec 1989, Fig. 28



n°8 : 6C'-1f

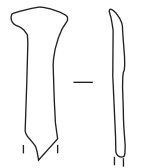

n°9 : 12E'-1f

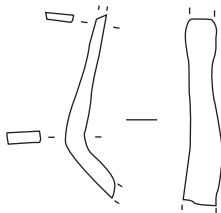

n°10 : 14H'-6g

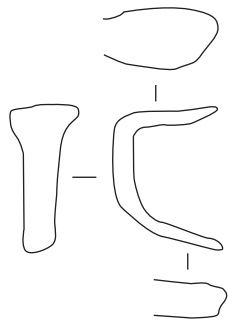

n°11 : B1-4f

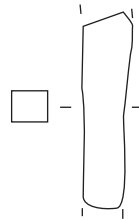

n°12 : B'7-4f

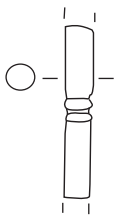

n°13 : D'après Lagadec 1989, Fig. 28, n°10

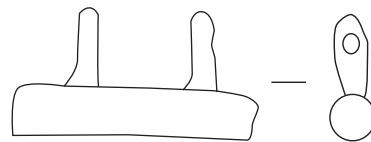

n°14 : D'après Lagadec 1989, Fig. 28, n°9



n°15 : D'après Lagadec 1989, Fig. 28, n°7

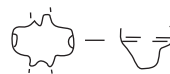

n°16 : 20G'-z

n°1 à 12 : fer ; n°13 à 16 : bronze

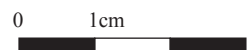

Illfurth  
Britzgyberg

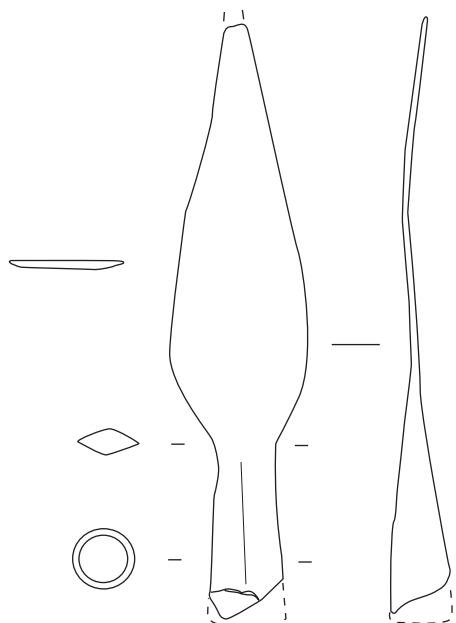

n°1 : M87-4

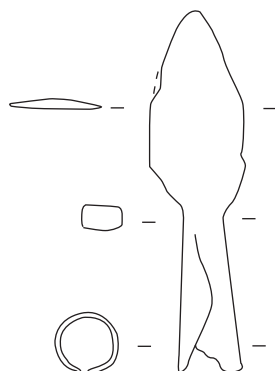

n°2 : M87-5

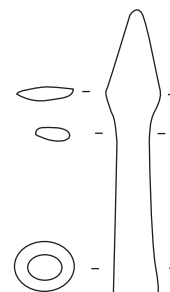

n°3 : M84-9

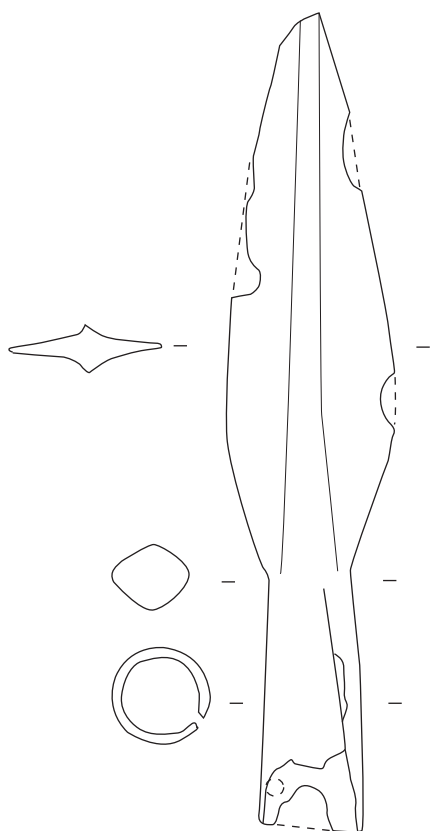

n°4 : M85-8

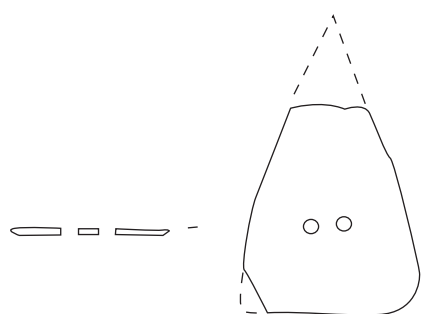

n°5 : M81-7

n°1 à 5 : fer

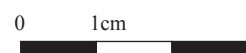

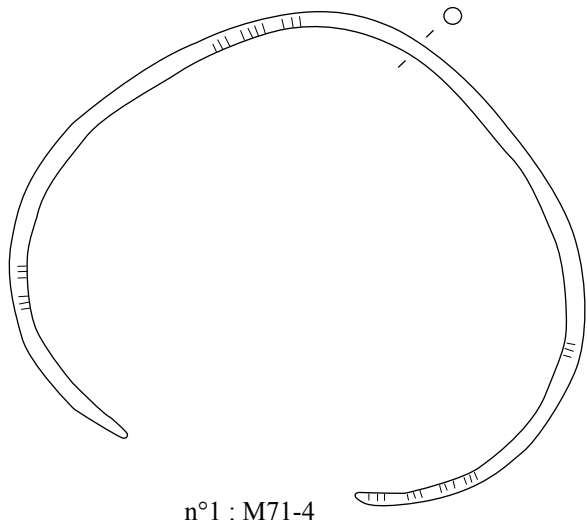

n°1 : M71-4

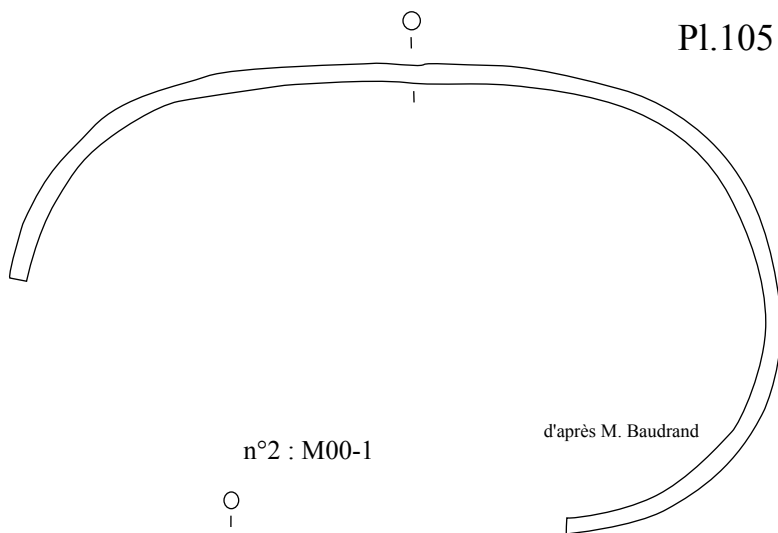

n°2 : M00-1

d'après M. Baudrand

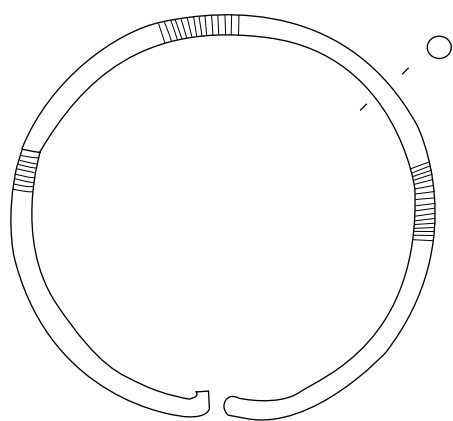

n°3 : M00-11

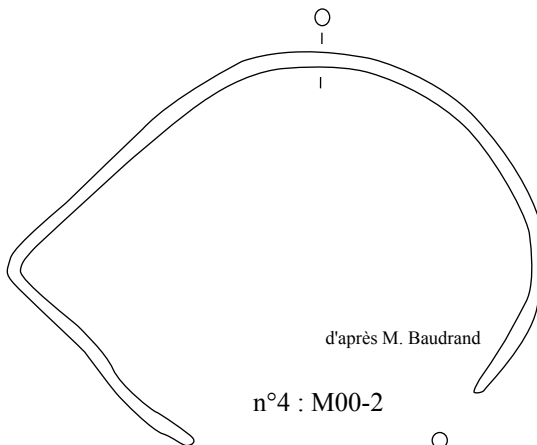

n°4 : M00-2

d'après M. Baudrand

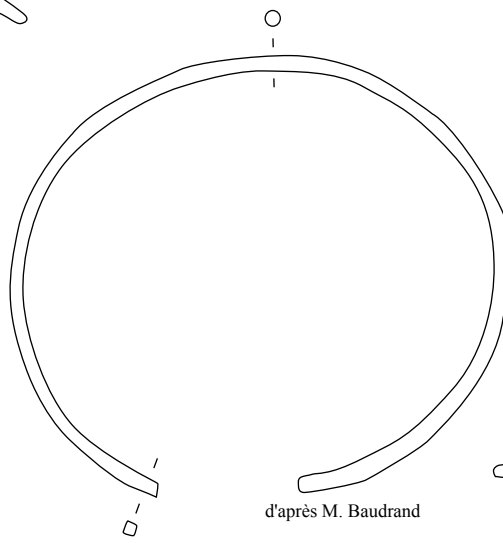

n°6 : M00-4

d'après M. Baudrand

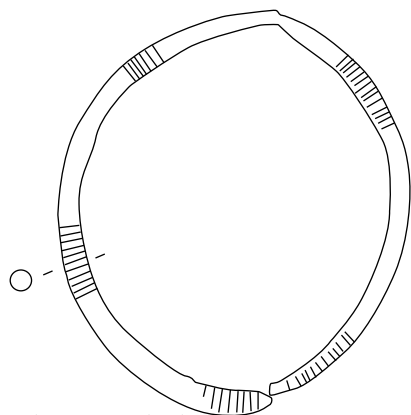

n°5 : M00-10

d'après M. Baudrand



n°10 : M89-1  
d'après M. Baudrand

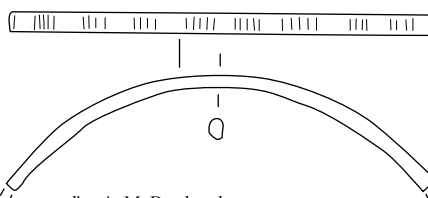

d'après M. Baudrand

n°8 : M68-8

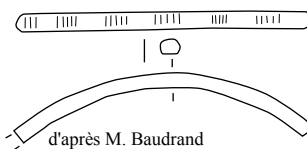

d'après M. Baudrand

n°9 : M84-16

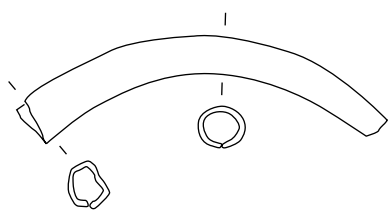

n°7 : M88-13

d'après M. Baudrand

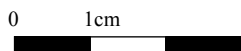

n°1 à 10 : bronze



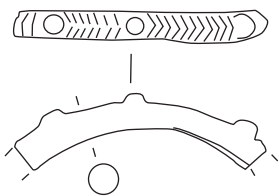

n°1 : M68-7  
d'après M. Baudrand

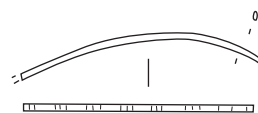

n°2 : M88-9

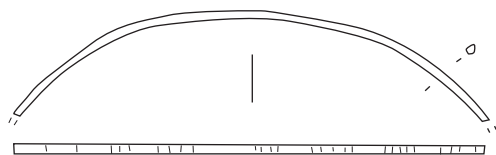

n°4 : M86-10



n°3 : M88-16

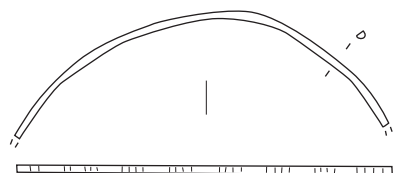

n°5 : M86-10

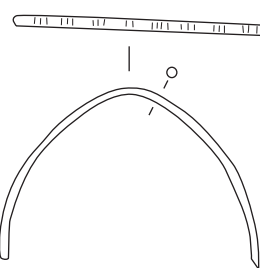

d'après M. Baudrand  
n°6 : M87-8

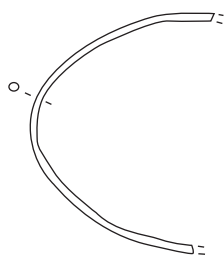

n°7 : M88-19



n°8 : M84-18

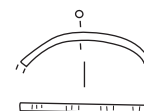

n°10 : M83-18

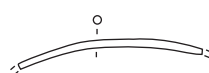

n°9 : M88-18

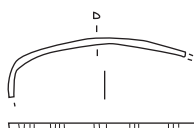

n°11 : M90-5

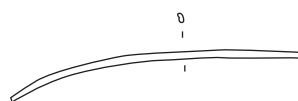

n°12 : M84-18

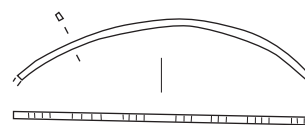

n°13 : M83-18

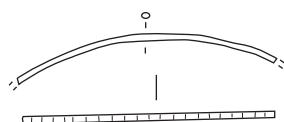

n°14 : M86-11

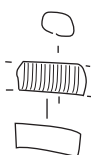

n°15 : M83-16

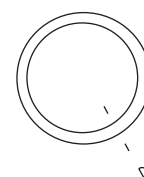

n°16 : M86-21

n°1 à 16 : bronze



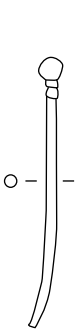

n°1 : M87-12  
d'après M. Baudrand

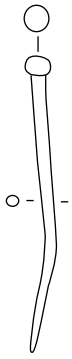

n°2 : M88-3  
d'après M. Baudrand

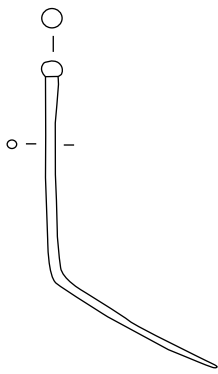

n°3 : M83-8  
d'après M. Baudrand

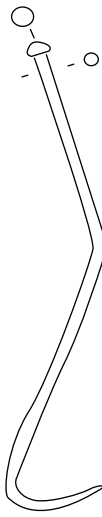

n°4 : M86-2



n°5 : M00-8  
d'après M. Baudrand

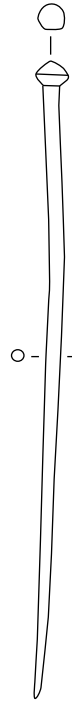

n°6 : M00-6  
d'après M. Baudrand

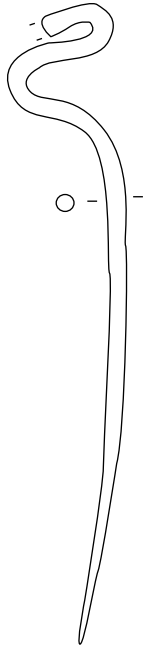

n°7 : M85-9  
d'après M. Baudrand

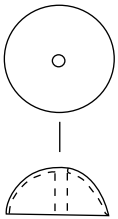

n°8 : M71-5

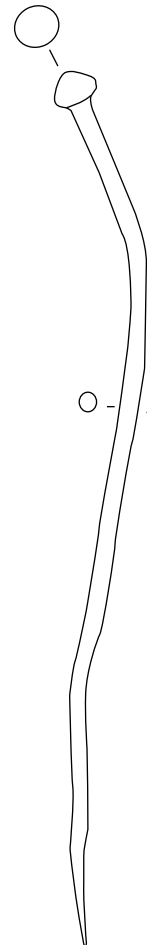

n°12 : M00-5  
d'après M. Baudrand

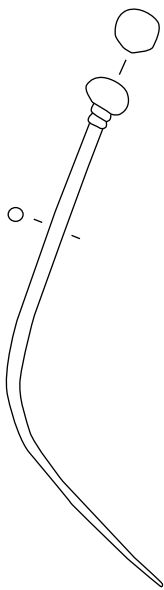

n°9 : M00-7  
d'après M. Baudrand

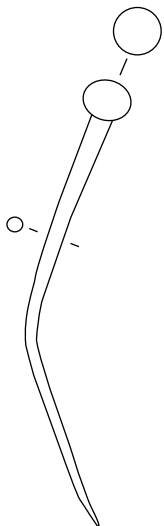

n°10 : M87-2  
d'après M. Baudrand

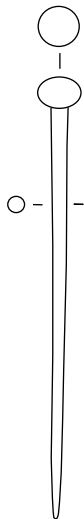

n°11 : M87-1  
d'après M. Baudrand

n°1 à 12 : Bronze

0 1cm

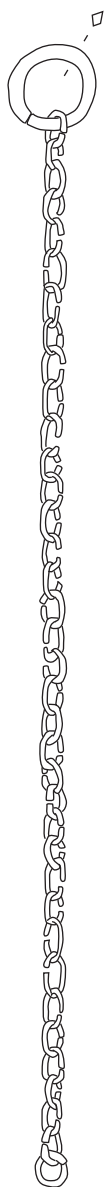

d'après M. Baudrand  
n°1 : M72-1

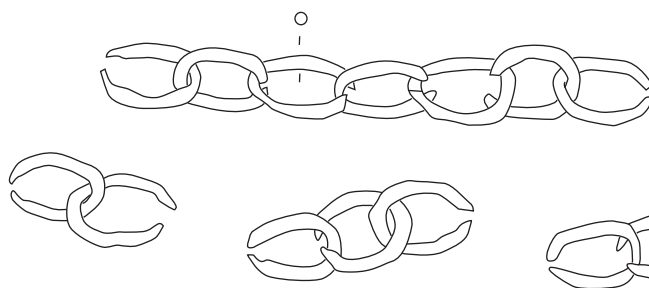

n°4 : LAM : 25069-44

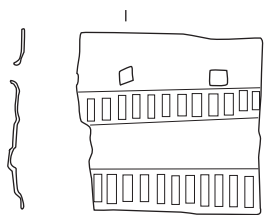

d'après M. Baudrand  
n°2 : M72-4

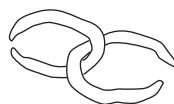

n°5 : M68-6

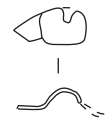

n°6 : M83-15

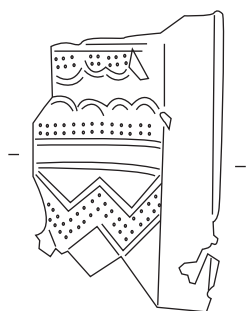

n°3 : M83-3  
d'après M. Baudrand

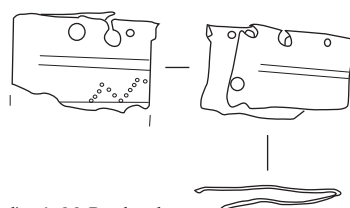

d'après M. Baudrand  
n°7 : M83-12

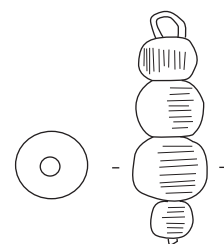

d'après M. Baudrand  
n°8 : M88-10

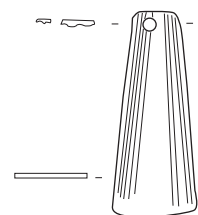

n°9 : M73-3

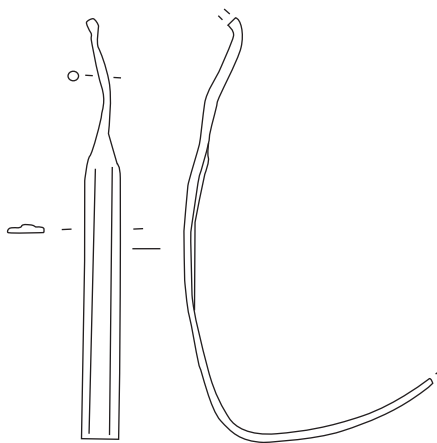

d'après M. Baudrand  
n°11 : M00-3

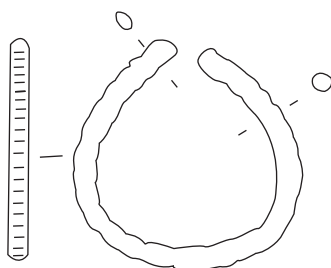

n°10 : M83-17

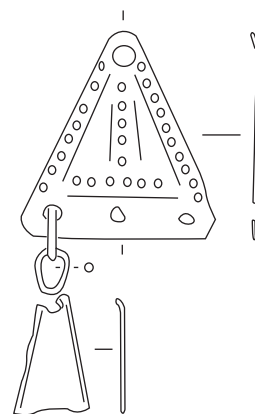

n°12 : M88-6  
d'après M. Baudrand

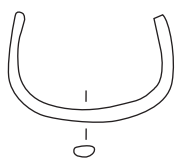

n°13 : M87-13  
d'après M. Baudrand

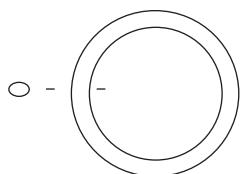

n°14 : M71-6

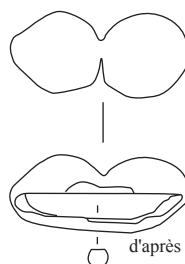

d'après M. Baudrand  
n°15 : M85-1

n°1 à 15 : bronze, sauf n°4 : fer

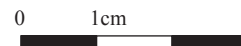

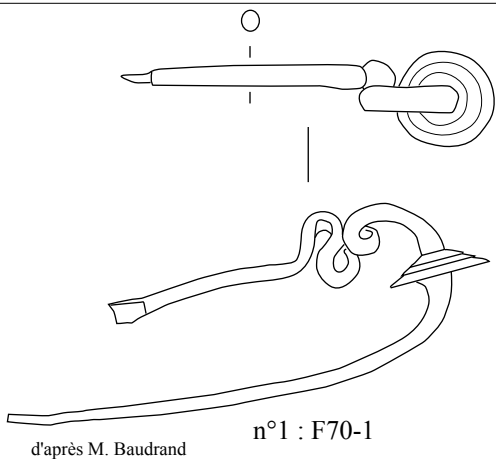

d'après M. Baudrand

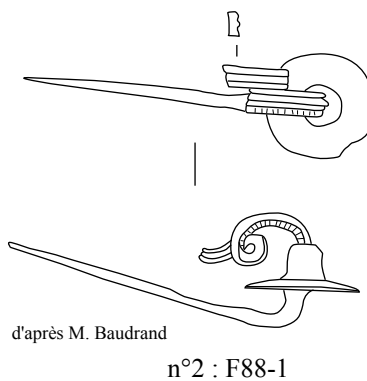

d'après M. Baudrand

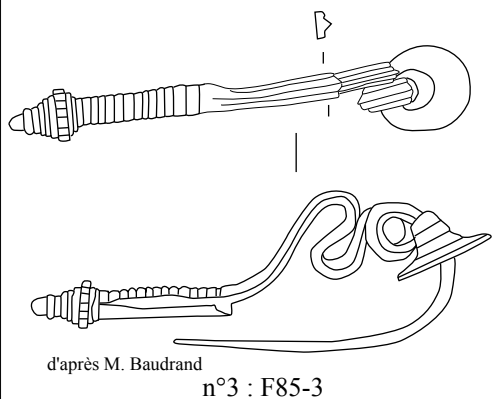

d'après M. Baudrand

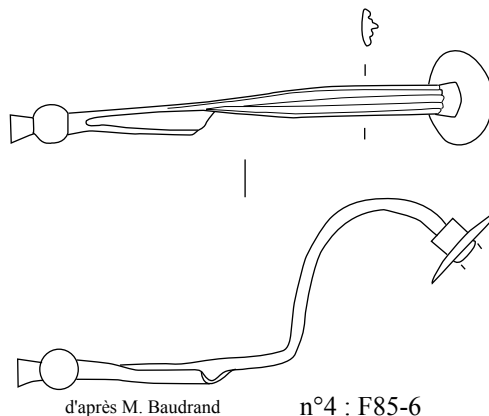

d'après M. Baudrand

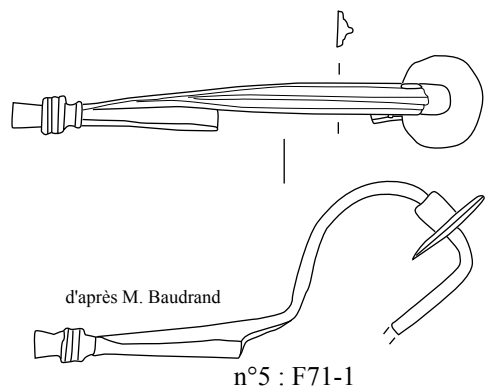

d'après M. Baudrand

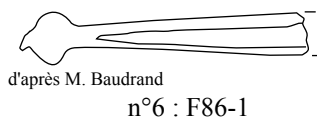

d'après M. Baudrand

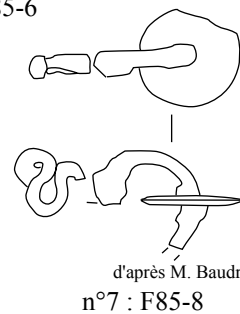

d'après M. Baudrand

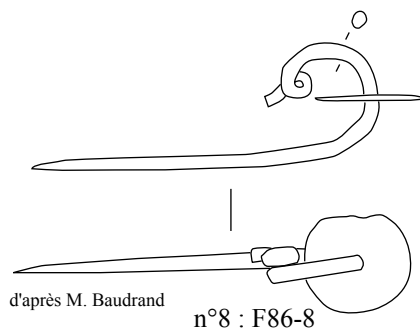
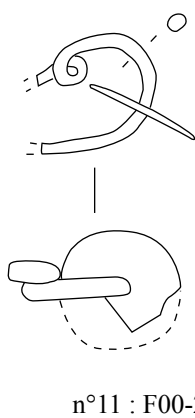

d'après M. Baudrand

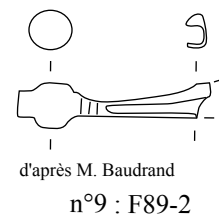

d'après M. Baudrand

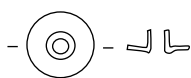
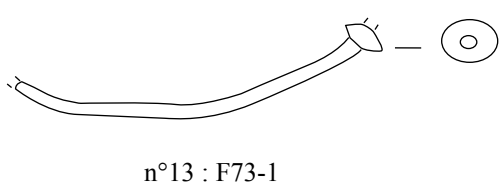
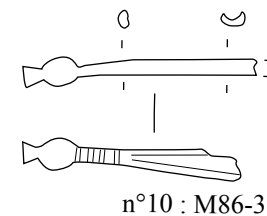
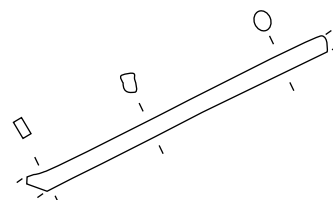

d'après M. Baudrand

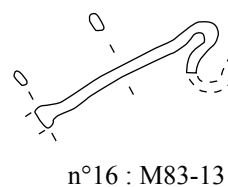
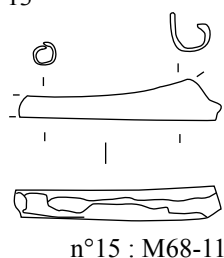

0 1cm

n°1 à 16 : bronze

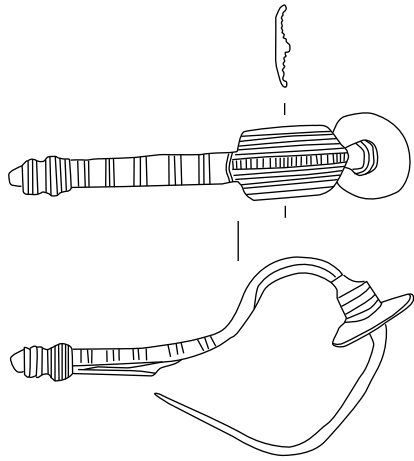

n°1 : F83-1  
d'après M. Baudrand

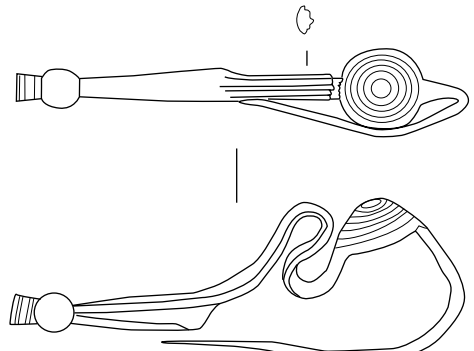

d'après M. Baudrand n°2 : F85-5

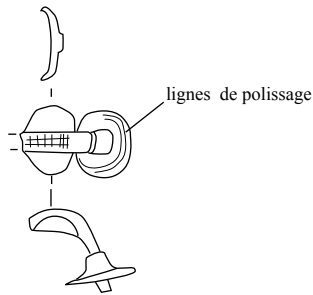

n°3 : F89-1

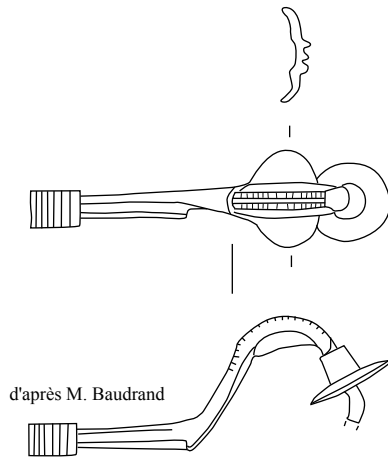

d'après M. Baudrand

n°4 : F85-9

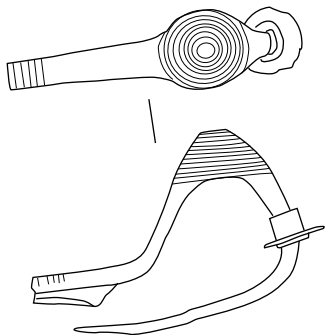

n°5 : F88-2  
d'après M. Baudrand

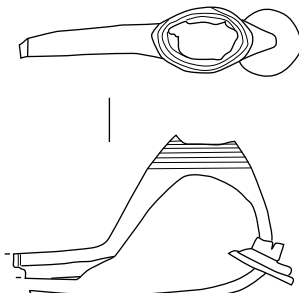

d'après M. Baudrand  
n°6 : F88-3

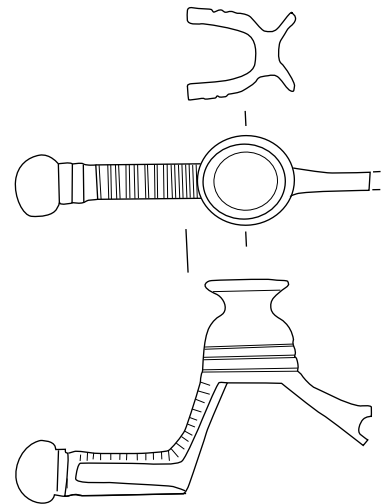

d'après M. Baudrand n°7 : F85-4

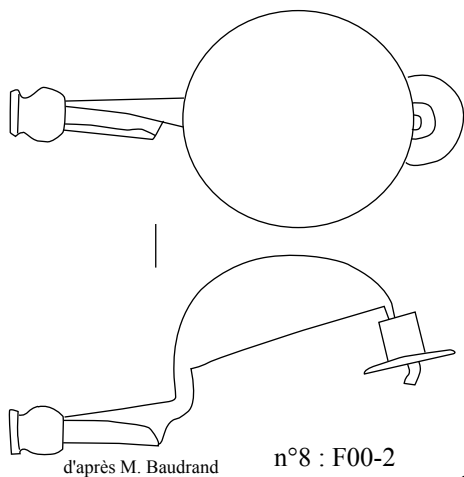

d'après M. Baudrand n°8 : F00-2

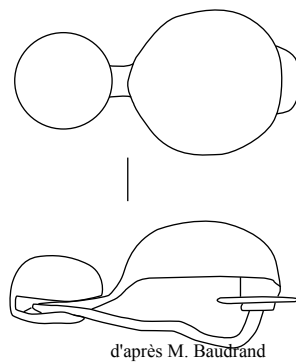

d'après M. Baudrand

n°9 : F85-7

n°1 à 9 : Bronze

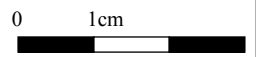

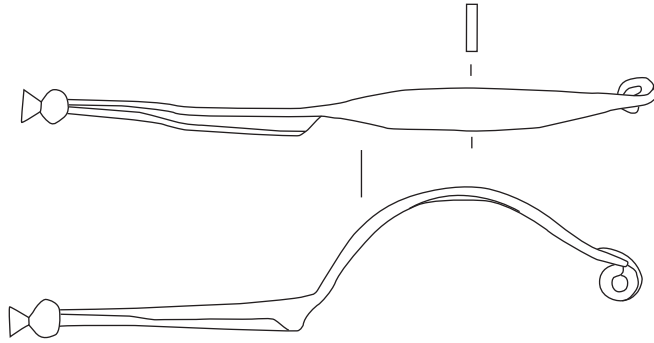

d'après M. Baudrand

n°1 : F83-2

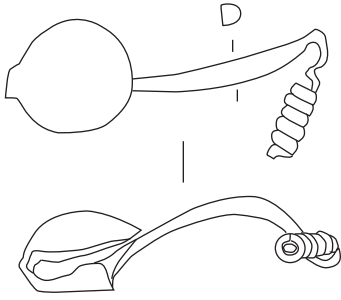

d'après M. Baudrand

n°2 : F83-3

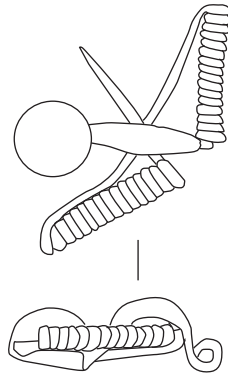

d'après M. Baudrand

n°3 : F85-10

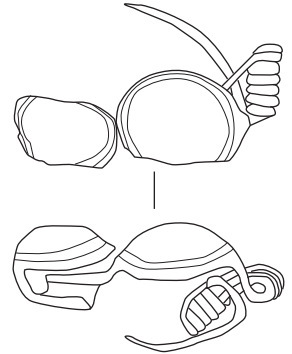

d'après M. Baudrand

n°4 : F71-10

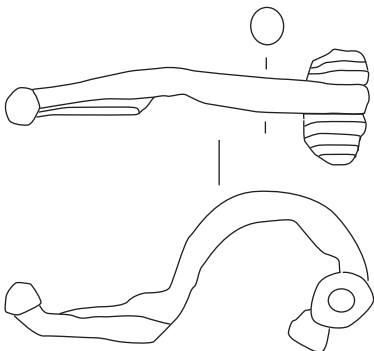

d'après M. Baudrand

n°5 : F85-1

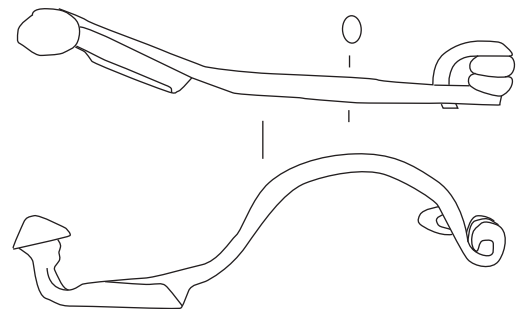

d'après M. Baudrand

n°7 : F66-1

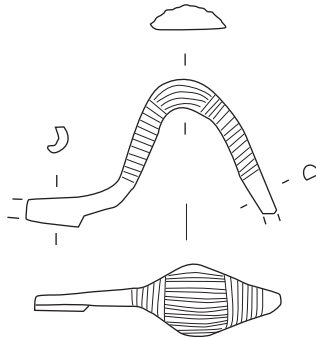

n°6 : F73-2

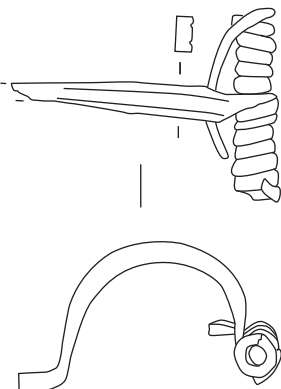

d'après M. Baudrand

n°8 : F70-2

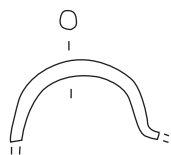

n°9 : F00-1

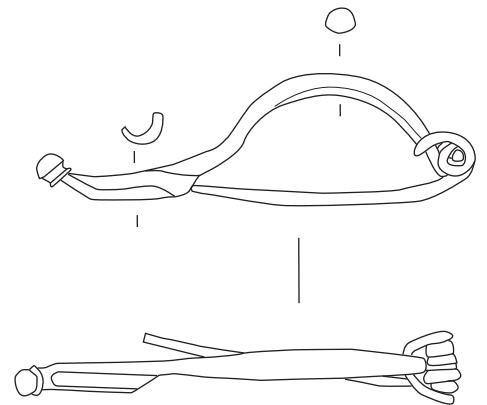

d'après M. Baudrand

n°10 : F85-11

n°1 à 9 : bronze sauf n°5-6-10 : fer

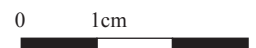

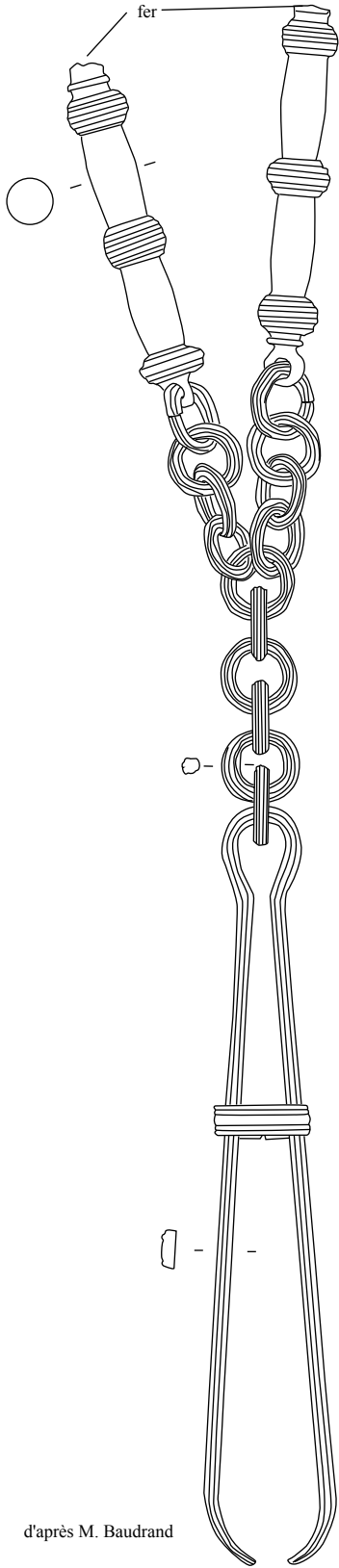

d'après M. Baudrand

n°1 : M85-4

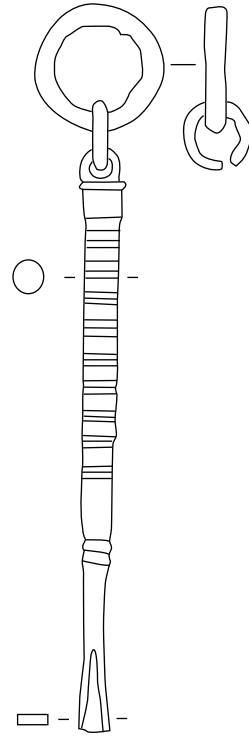

d'après M. Baudrand  
n°2 : M68-3

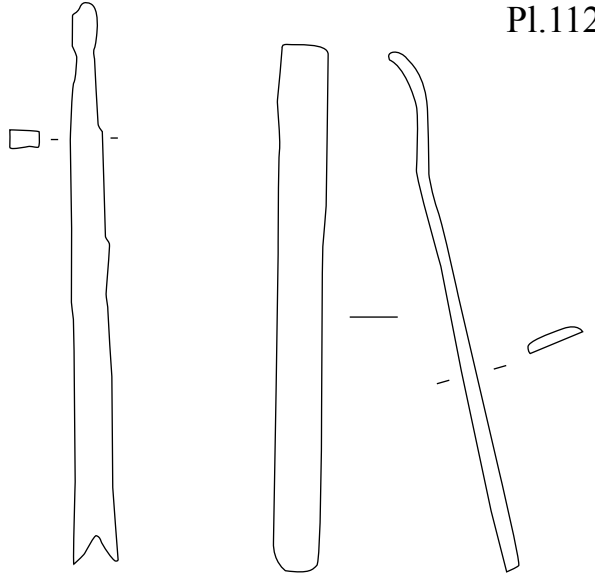

n°3 : M87-7  
d'après M. Baudrand

n°4 : M86-13

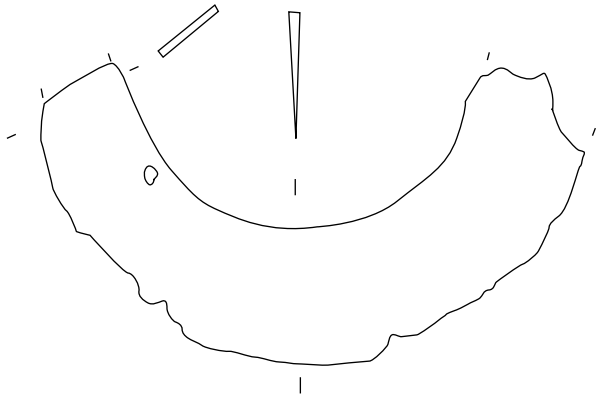

n°5 : M00-19

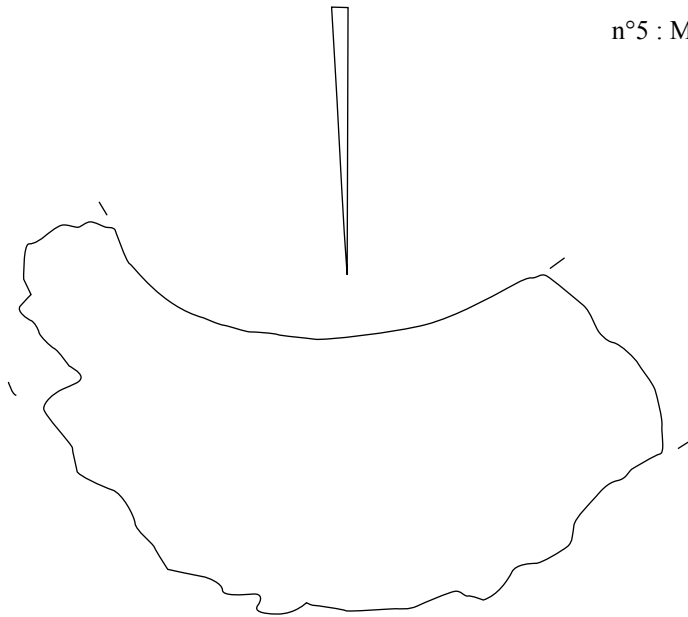

n°6 : M00-18

n°2 à 6 : fer sauf n°1 : bronze

0 1cm



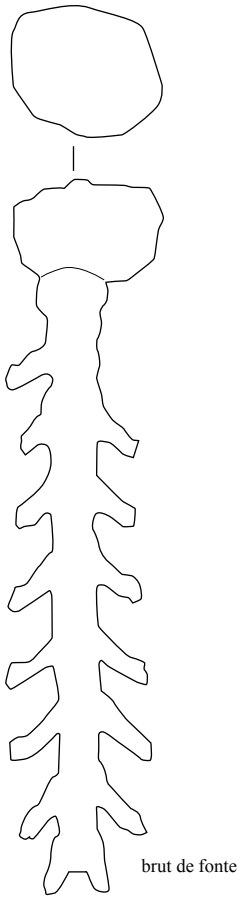

n°1 : M71-1  
d'après M. Baudrand

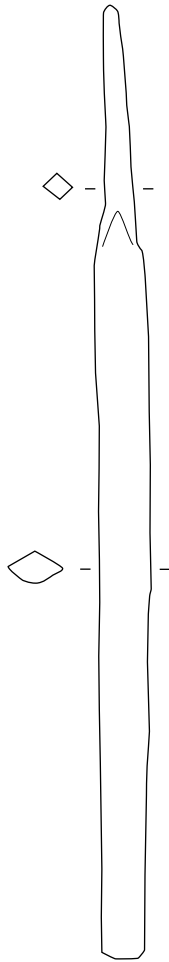

brut de fonte  
n°2 : M68-1  
d'après M. Baudrand

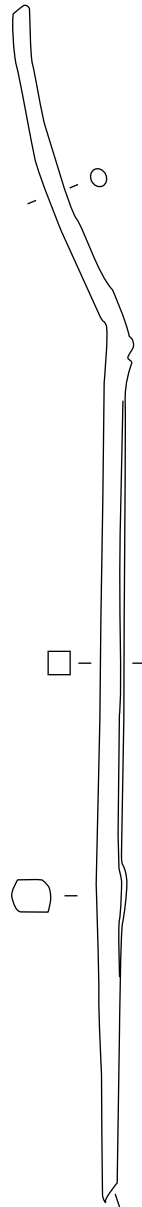

trace de découpe  
n°3 : M68-2  
d'après M. Baudrand

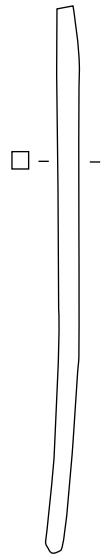

n°4 : M87-16

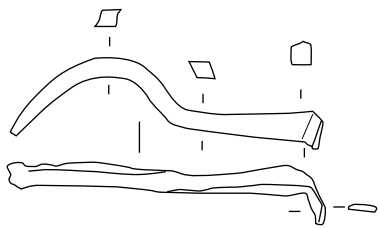

n°5 : M86-6  
d'après M. Baudrand

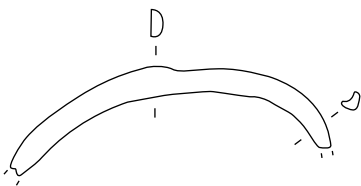

n°6 : M87-19

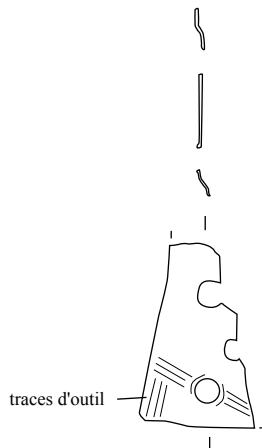

traces d'outil  
n°7 : M88-14  
d'après M. Baudrand

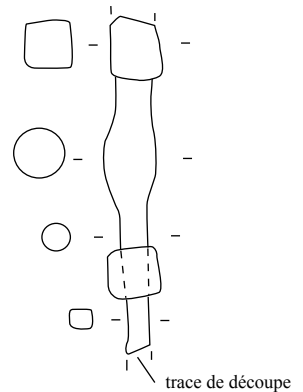

trace de découpe  
n°8 : M86-07

n°1 à 4 : fer sauf n°5 à 8 : fer

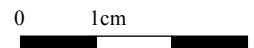



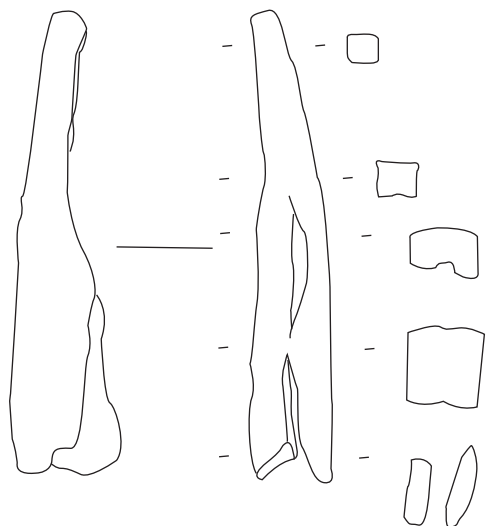
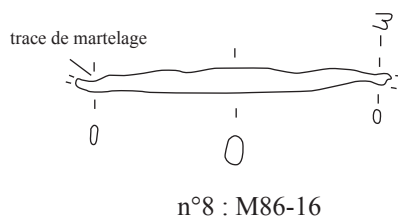
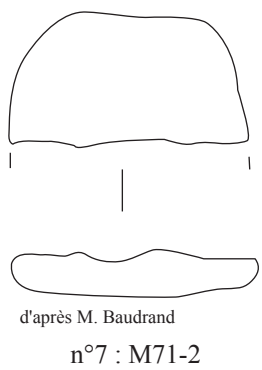
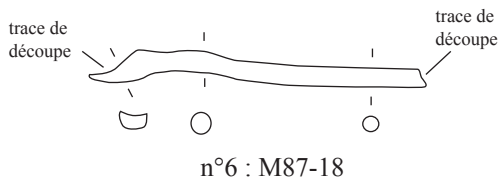
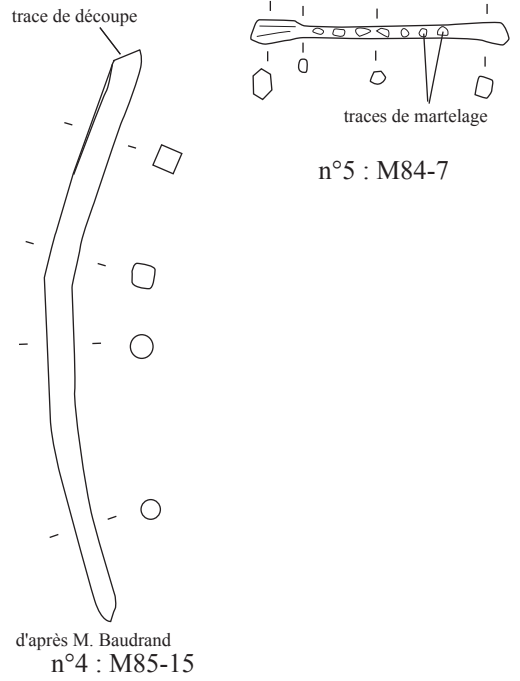
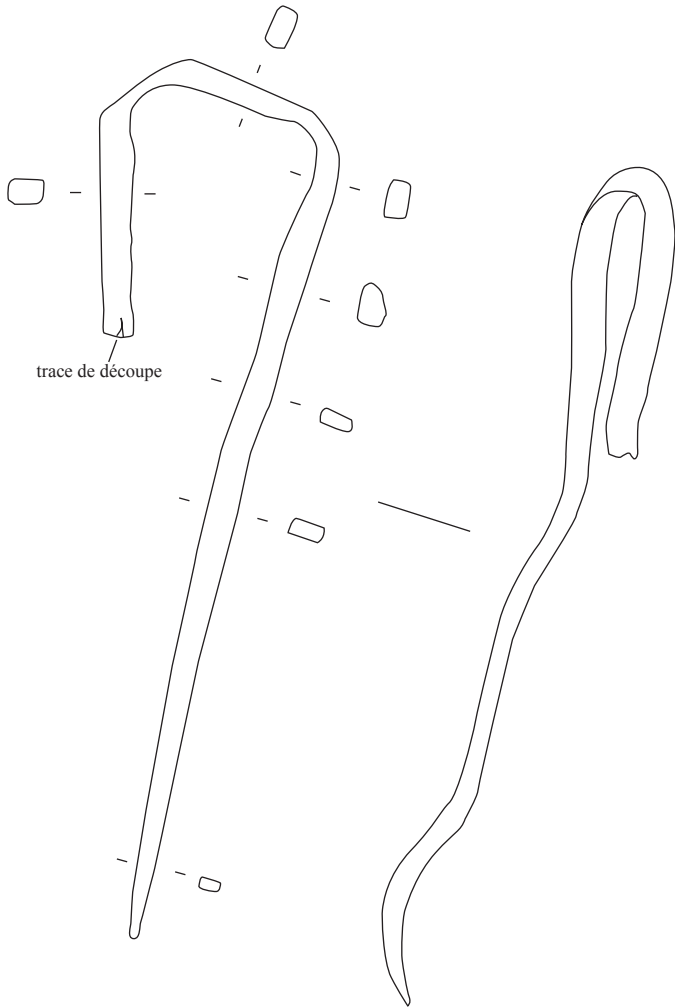
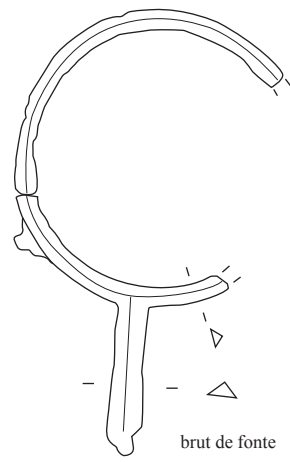
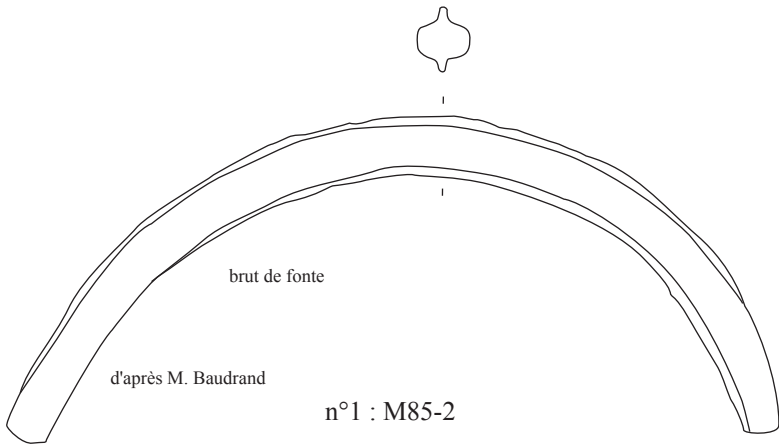

n°3 à 9 : fer sauf n°1-2-5-7 : bronze

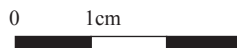

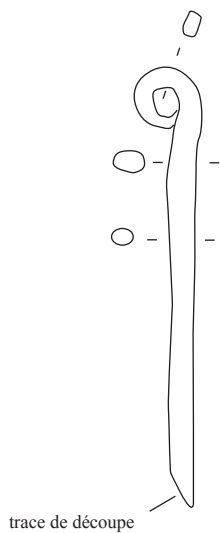

n°1 : M86-12

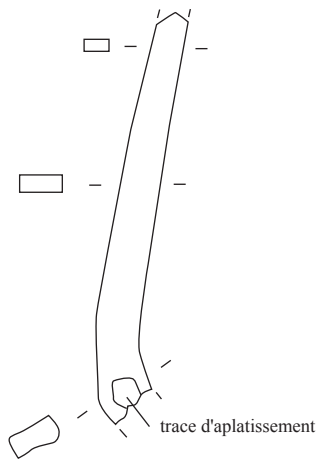

n°2 : M68-14

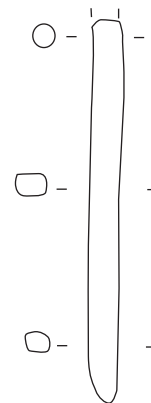

n°3 : M85-20

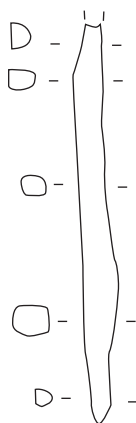

n°4 : M90-2

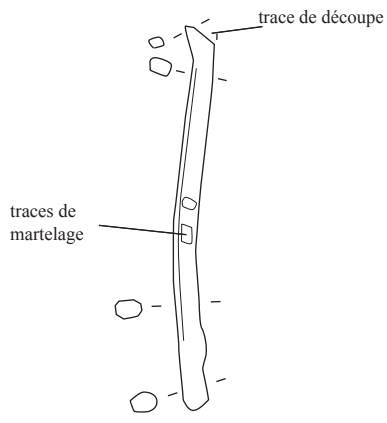

n°5 : M86-17

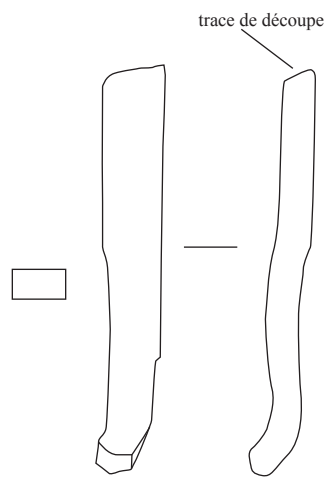

n°6 : M87-14  
d'après M. Baudrand

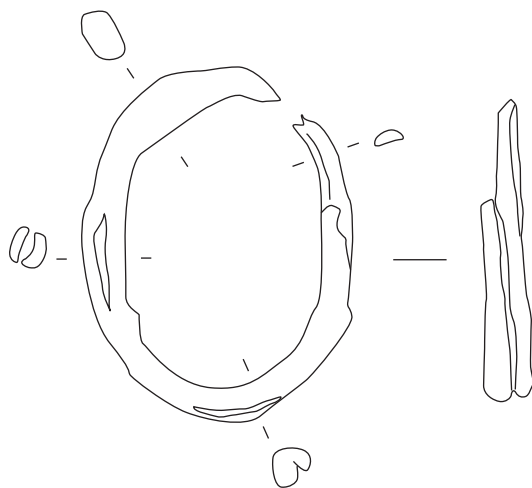

n°7 : M85-16

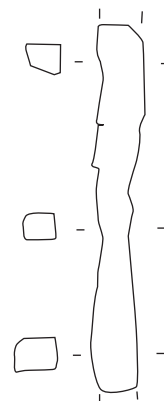
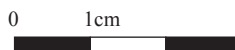

n°8 : M86-8

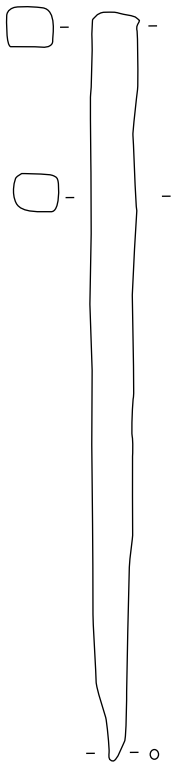

n°1 : M87-20

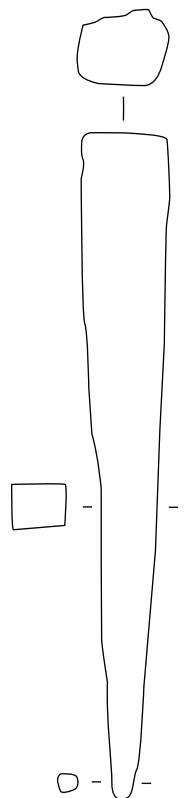

n°2 : M81-1

d'après M. Baudrand

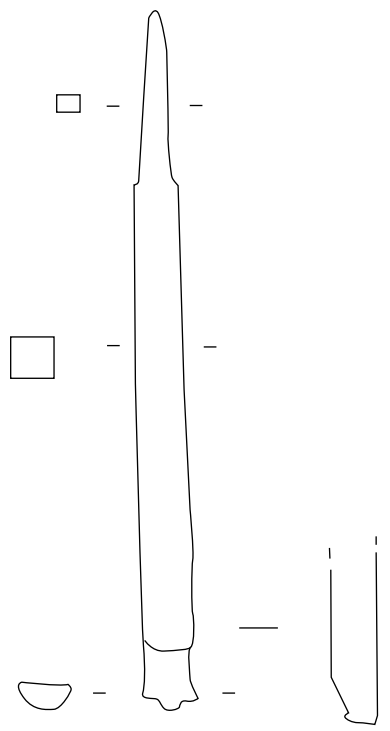

n°3 : M83-10

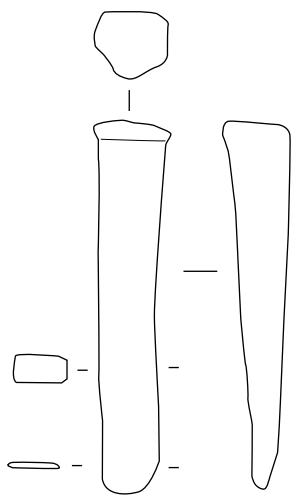

n°4 : M72-5  
d'après M. Baudrand

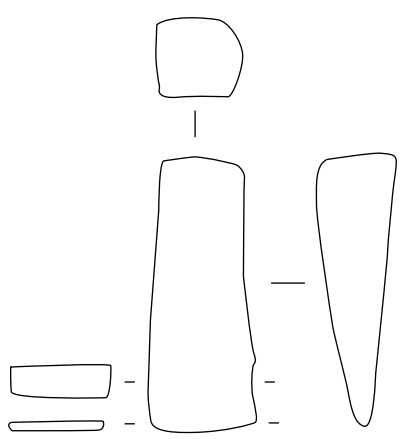

n°5 : M84-17  
d'après M. Baudrand



n°6 : M83-11  
d'après M. Baudrand

n°1 à 6 : fer

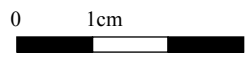

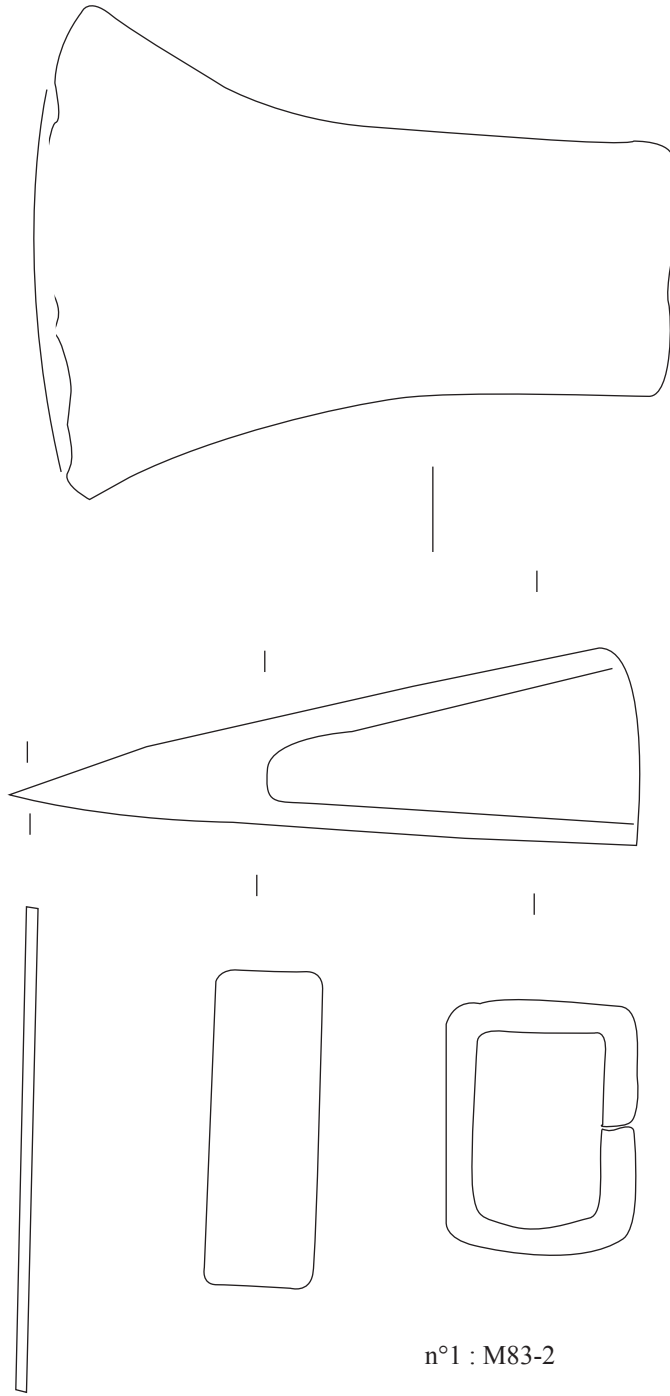

n°1 : M83-2

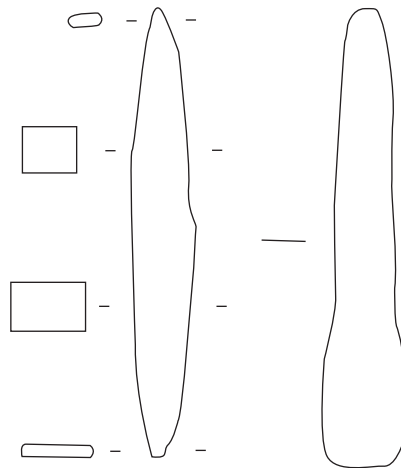

n°2 : M71-13

n°1 à 2 : fer

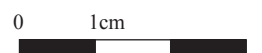

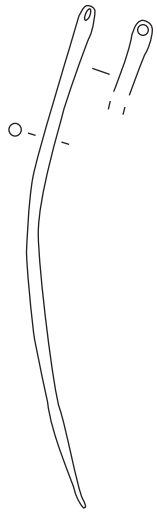

n°1 : M88-5  
d'après M. Baudrand

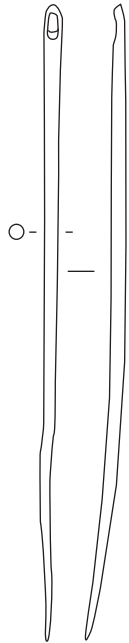

n°2 : M88-4  
d'après M. Baudrand

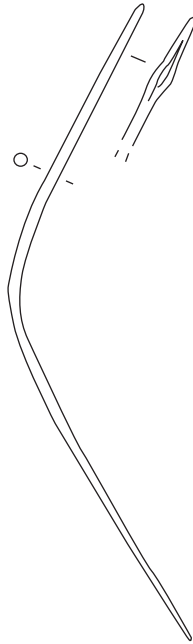

d'après M. Baudrand  
n°3 : M84-5

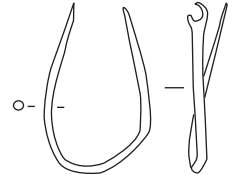

d'après M. Baudrand  
n°4 : M84-4

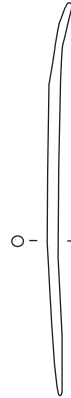

d'après M. Baudrand  
n°5 : M87-9

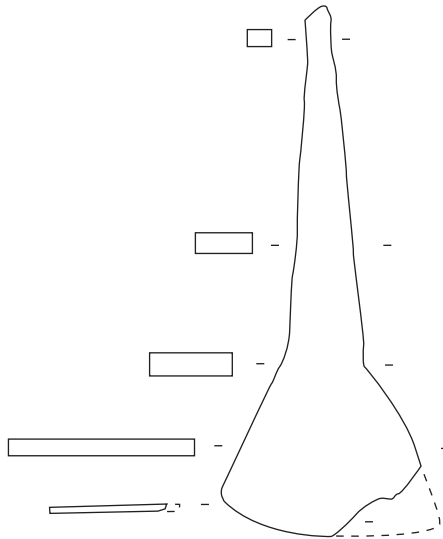

n°6 : M84-2

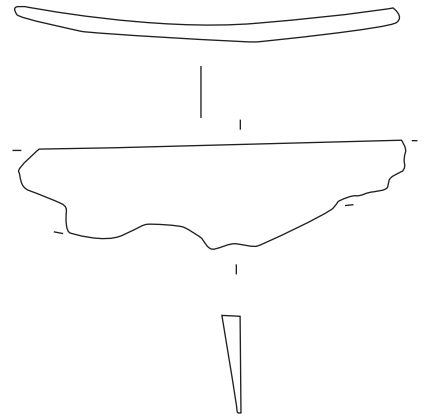

n°7 : M86-9

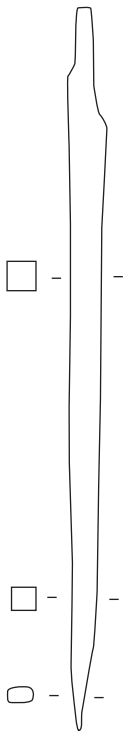

d'après M. Baudrand  
n°8 : M85-14

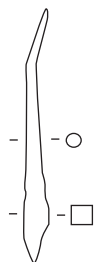

n°9 : M87-9  
d'après M. Baudrand

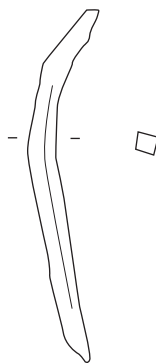

n°10 : M86-4  
d'après M. Baudrand

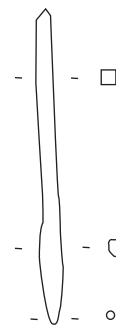

n°11 : M68-16

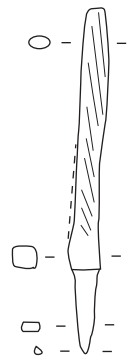

n°12 : M86-22

bois

n°6 à 12 : fer ; n°1 à 5 : bronze



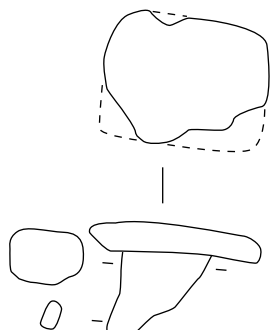

n°1 : M90-4

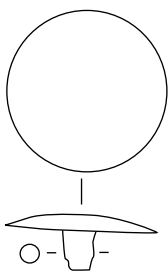

n°2 : M72-2  
d'après M. Baudrand

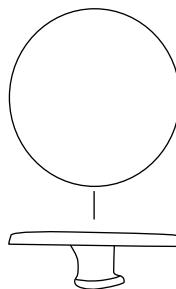

n°3 : M72-3  
d'après M. Baudrand

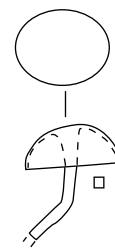

n°4 : M73-1

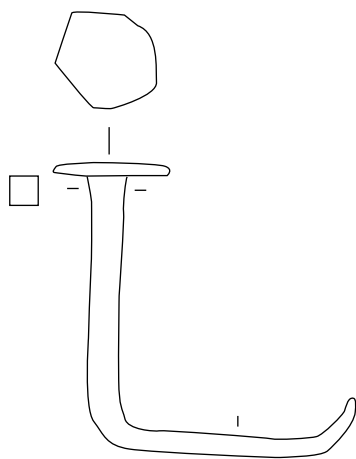

n°5 : M85-19

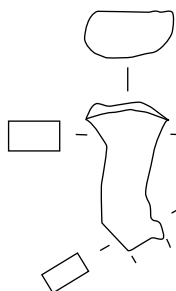

n°6 : M88-17

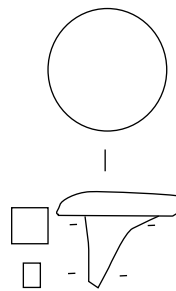

n°7 : M88-17

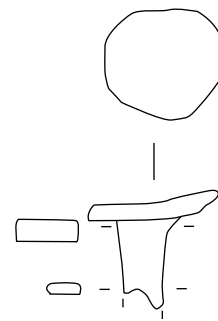

n°8 : M87-21

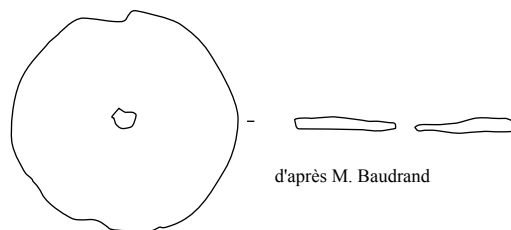

n°9 : M72-4

d'après M. Baudrand

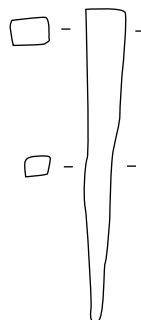

n°10 : M71-12

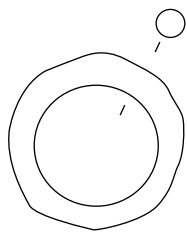

n°11 : M86-11

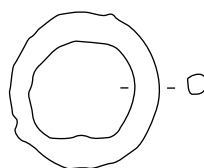

n°12 : M86-5  
d'après M. Baudrand

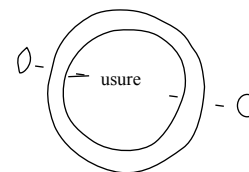

n°13 : M00-12  
d'après M. Baudrand

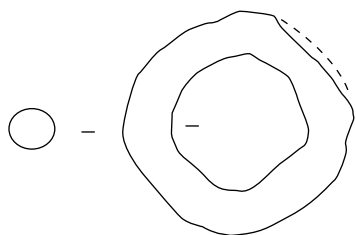

n°14 : M81-2

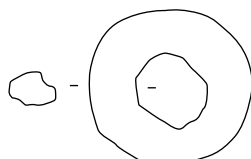

n°15 : M83-5  
d'après M. Baudrand



n°16 : M86-20



n°17 : M71-7

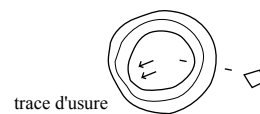

n°18 : M83-14

0 1cm

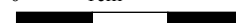

n°1-5 à 8-14-15 : fer ; n°2 à 4-9-11 à 13-16 à 18 : bronze

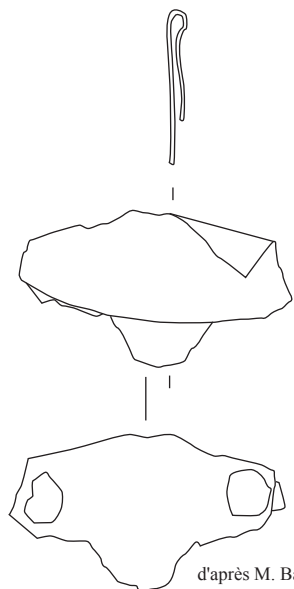

n°1 : M87-10

d'après M. Baudrand

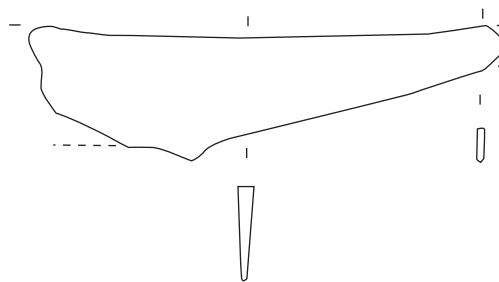

n°2 : M87-23

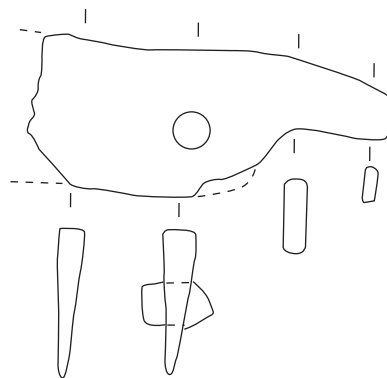

n°3 : M85-18

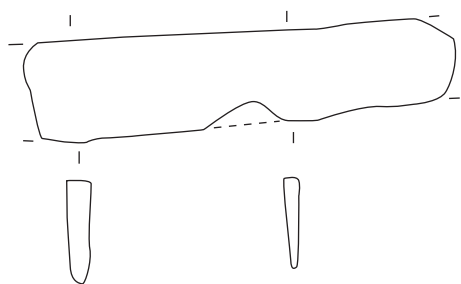

n°4 : M89-2

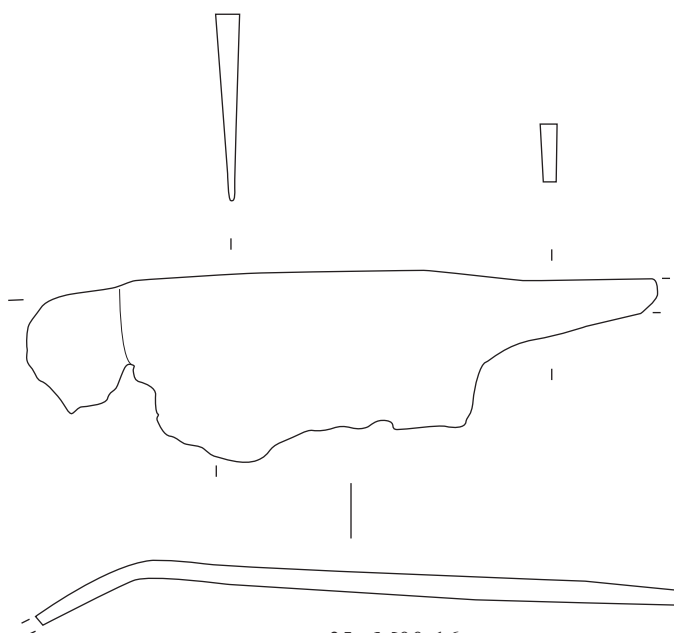

n°5 : M00-16



n°2 à 5 : fer sauf n°1 : bronze

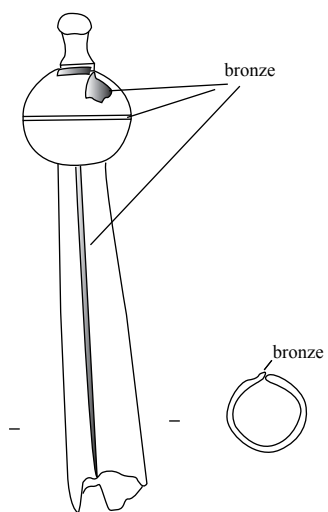

n°1 : LAM 25070-47

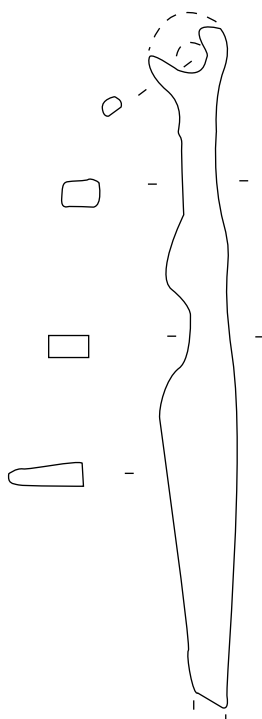

n°2 : M84-1

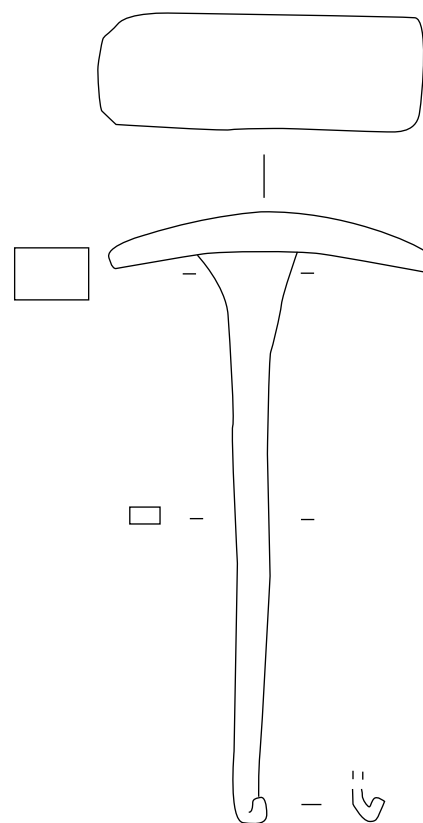

n°3 : M85-7

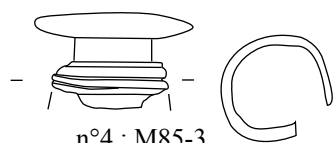
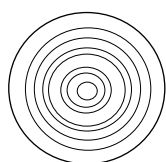

n°4 : M85-3

d'après M. Baudrand

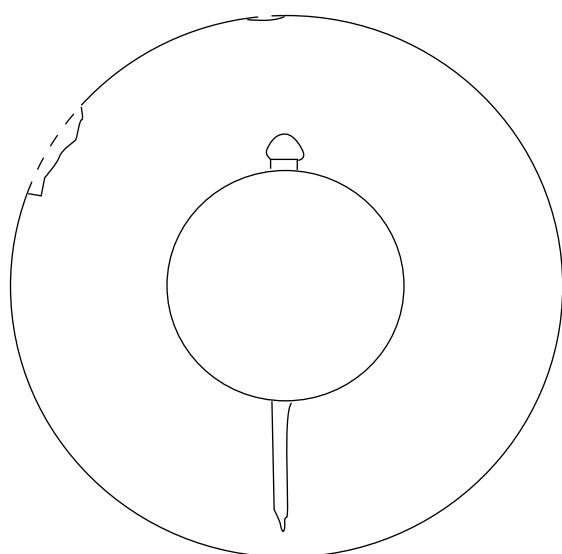

n°5 : M88-1

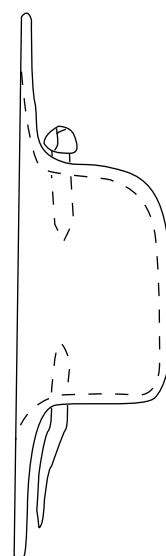

n°1 à 5 : fer sauf n°4 : bronze

0 1cm

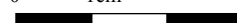



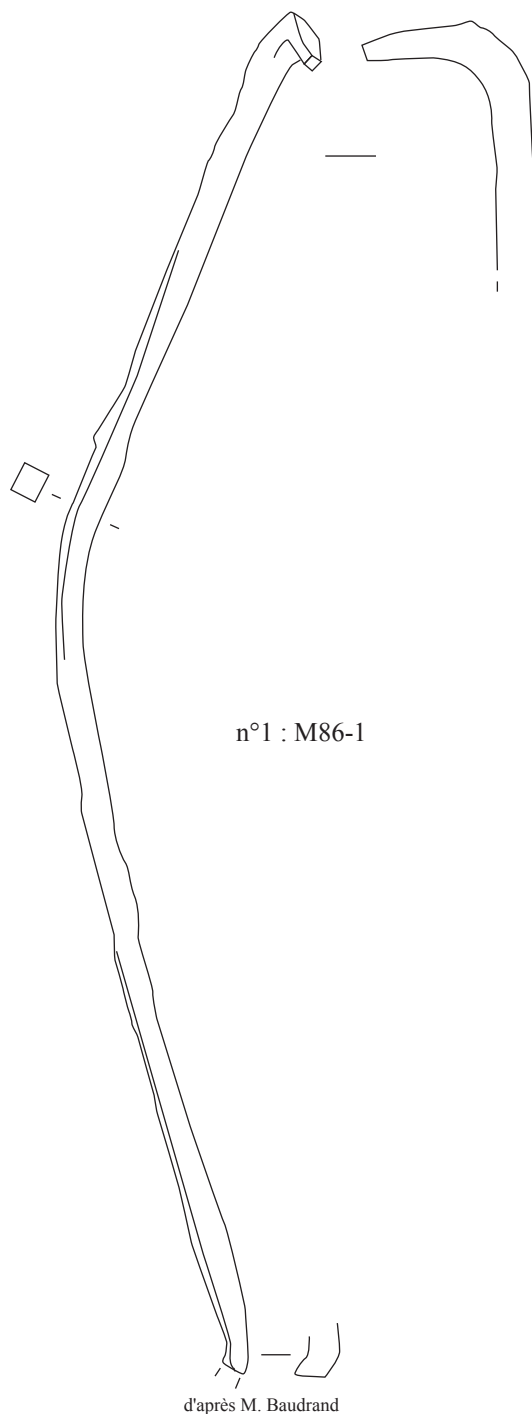

d'après M. Baudrand



n°1 : fer

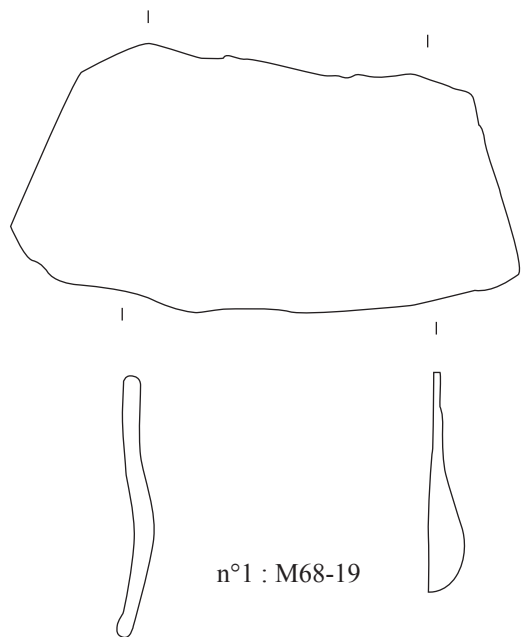

n°1 : M68-19

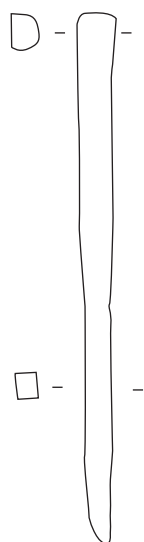

n°2 : M71-11

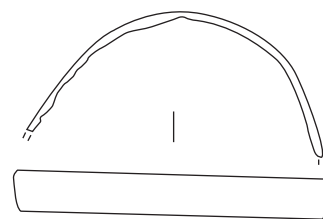

n°3 : M68-17

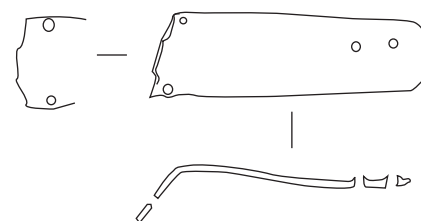

n°4 : M68-13

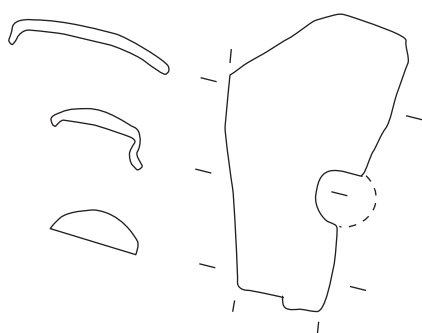

n°5 : M86-10

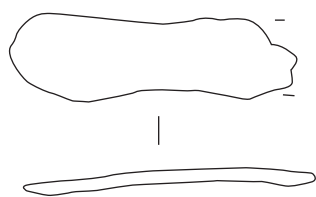
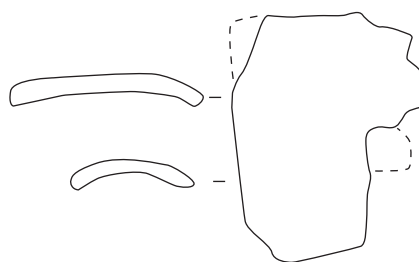

n°6 : M68-15

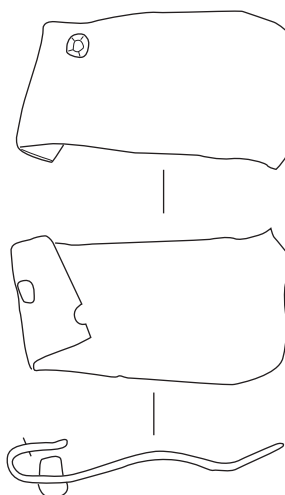

n°7 : M86-14

n°1 à 6 : fer sauf n°7 : bronze

0 1cm

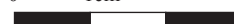



Posieux  
Châtillon-sur-Glâne

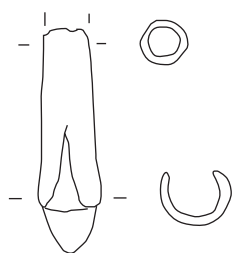

n°1 : VI-CHA 75

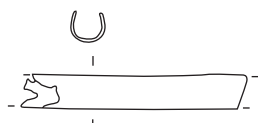

n°2 : 1988-781

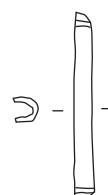

n°3 : 1975

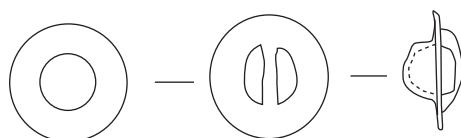

n°4 : 1980-663

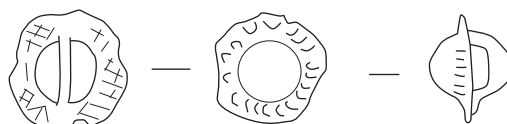

n°5 : 1993

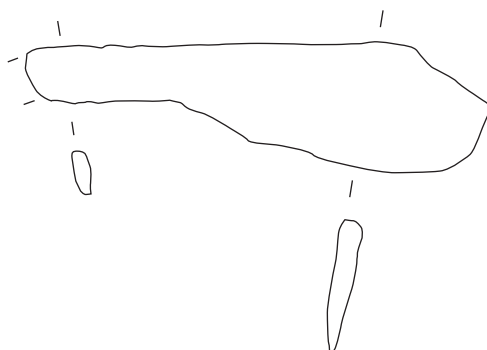

n°6 : VI-CHA 75

n°1-2-6: fer ; n°3 à 5 : bronze



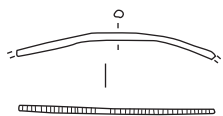

n°1 : 1980-661-sond.2

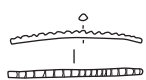

n°4 : 1980-662

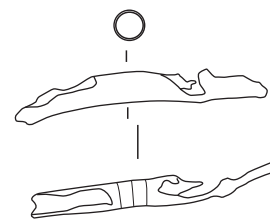

n°9 : 1980-660

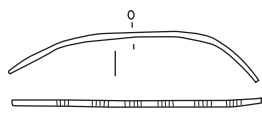

n°2 : 1977

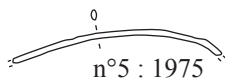

n°5 : 1975



n°3 : 1981-672

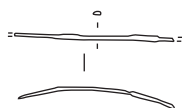

n°6 : 569

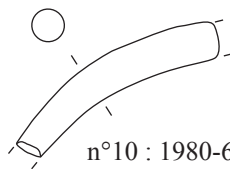

n°10 : 1980-664

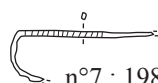

n°7 : 1981-809

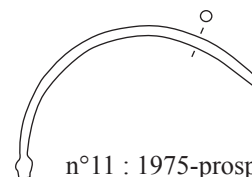

n°11 : 1975-prospection



n°8 : 1979-885

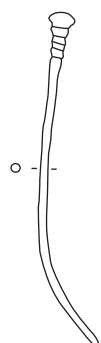

n°14 : 1976-53



n°15 : 1975-82

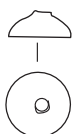

n°13 : 1980-872

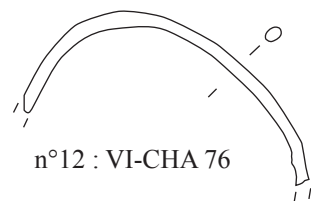

n°12 : VI-CHA 76



n°16 : 1993-plateau sup.



n°17 : 1977-  
Tr. I



n°18 : 1981-  
813

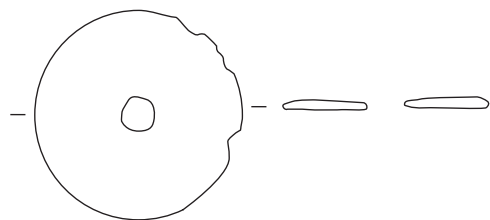

n°19 : 1980-875

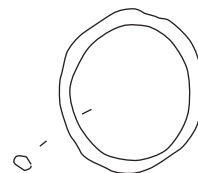

n°20 : VI-CHA 93/3

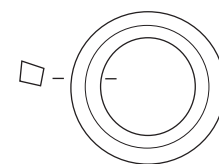

n°21 : VI-CHA  
1975

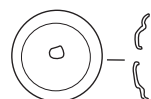

n°22 : VI-CHA 10

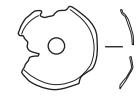

n°23 : 1977-M10

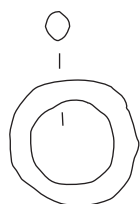

n°24 : VI-CHA  
93/3

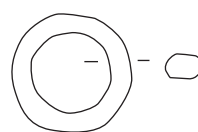

n°25 : VI-CHA  
93/2

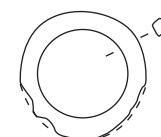

n°26 : 1975-577

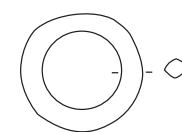

n°27 : 1978-578

n°1 à 27 : bronze

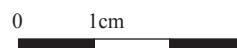

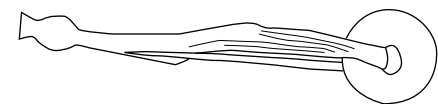

n°1 : 1981-805

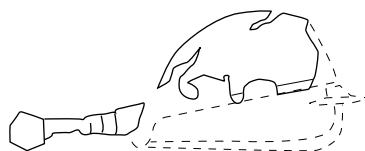
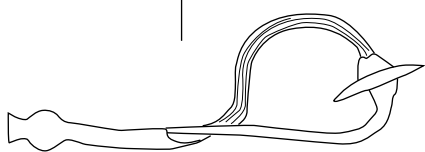

n°6 : 1988-712

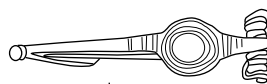

n°7 : 1979-563

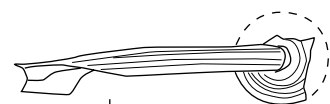

n°2 : 1981

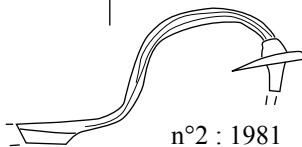

n°3 : 1981-806

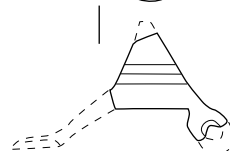
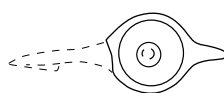

n°8 : 1988-1485



n°4 : 1980-658

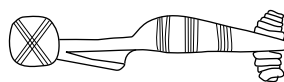
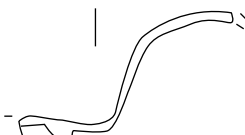

n°9 : 1975-871

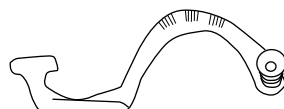

n°10 : 1975-868



n°5 : 1979-564

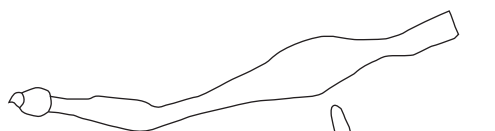
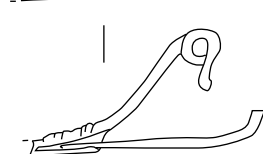

n°11 : 1975-869

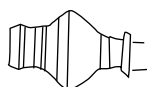
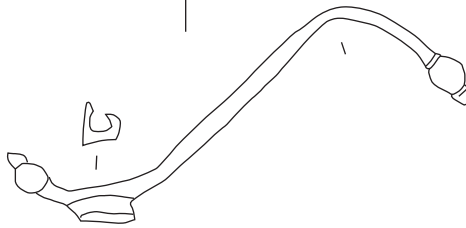

n°12 : VI CHA 1993



n°13 : 1980-659



n°14 : 1981-822

n°1 à 15 : bronze

0 1cm

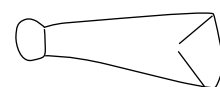

n°15 : 1977-10



n°1 : 1980-654

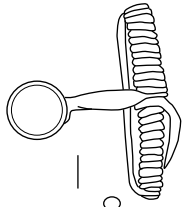

n°2 : 1975-75a

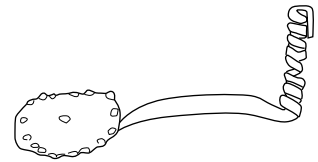

n°3 : 865

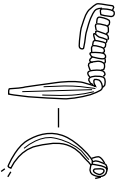

n°4 : 1975-82

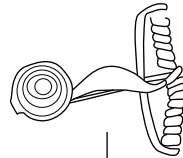

n°5 : 1976-75

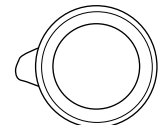

n°8 : VI CHA 1993

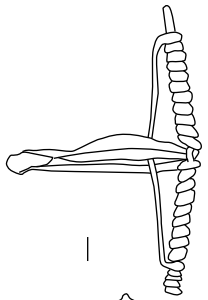

n°6 : 867

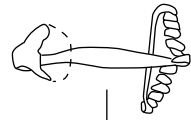

n°7 : VI CHA 1975-862

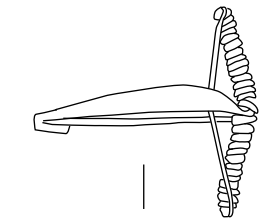

n°8 : VI CHA 1975-866

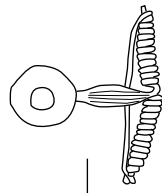

n°9 : VI CHA 1975-863

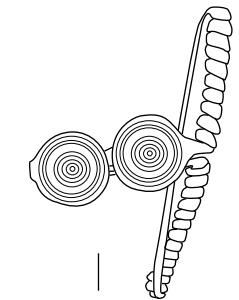

n°10 : 1977-74

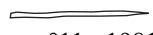

n°11 : 1981-n°3

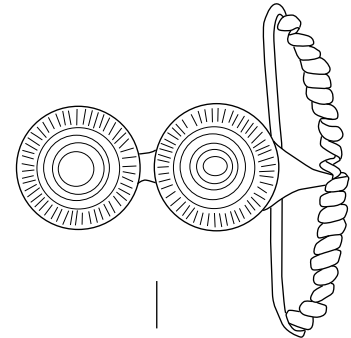

n°12 : 1981-n°3

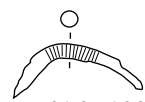

n°16 : 1980-669



n°13 : 1981



n°14 : 1989-3



n°17 : 1989



n°15 : VI-CHA 75/2

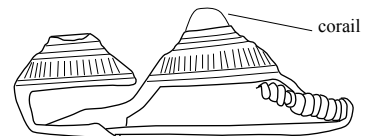

n°18 : VI-CHA 1973-860

n°1 à 18 : bronze

0 1cm

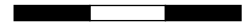





n°1 : 1975

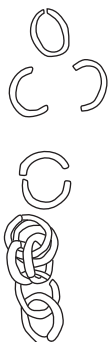

n°2 : 1988-776

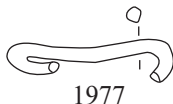

1977



n°3 : 1988-711

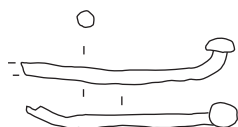

n°4 : 1980



n°6 : 1980-655

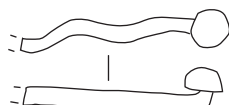

n°5 : VI-CHA 96



n°7 : VI-CHA 94

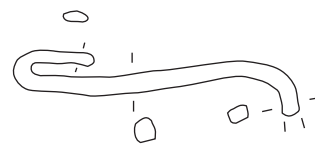

n°8 : 1979-70

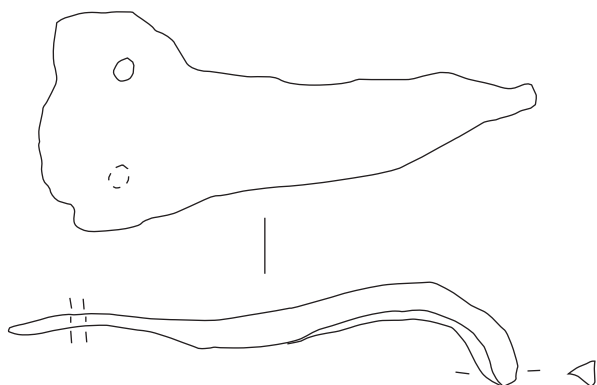

n°9 : VI-CHA 94

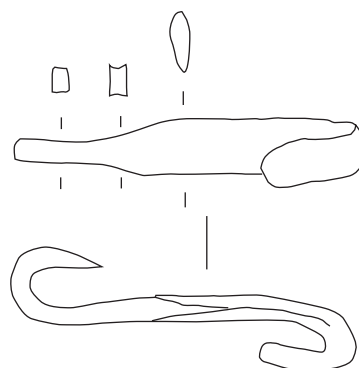

n°10 : 1981-881

1 à 6 : bronze ; n°7 à 10 : fer

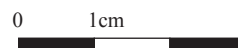

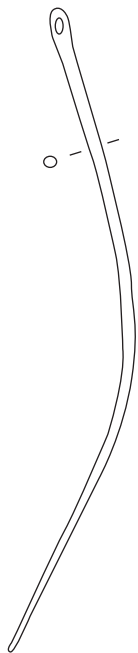

n°1 : 1989-856

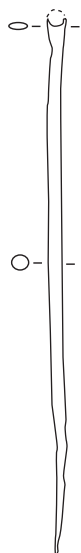

n°2 : 1979-566

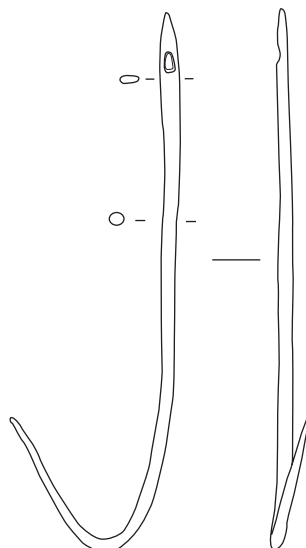

n°3 : 1978-565

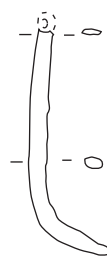

n°4 : 1988-162

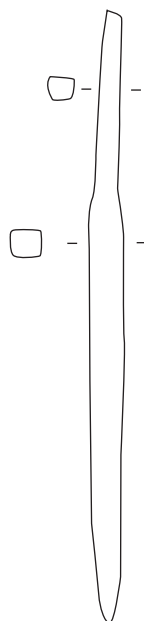

n°4 : 1988-340

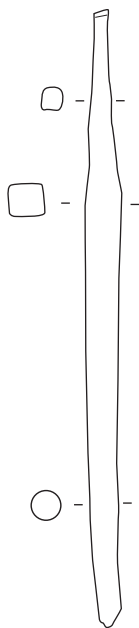

n°5 : 1981-817

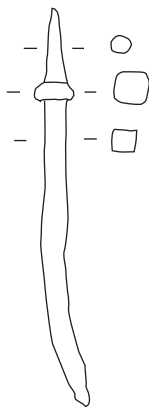

n°6 : 1981-818

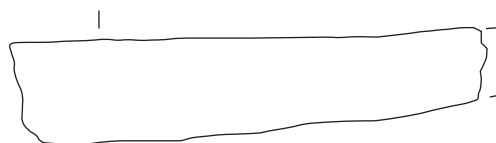

n°7 : 1975-876

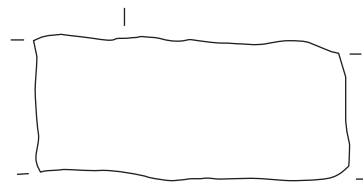

n°8 : 1993



n°9 : 1988-96

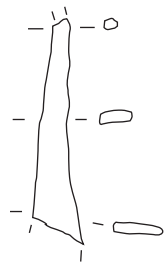

n°10 : 1988-85

n°1 à 3 : bronze ; n°4 à 10 : fer

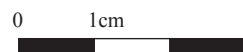

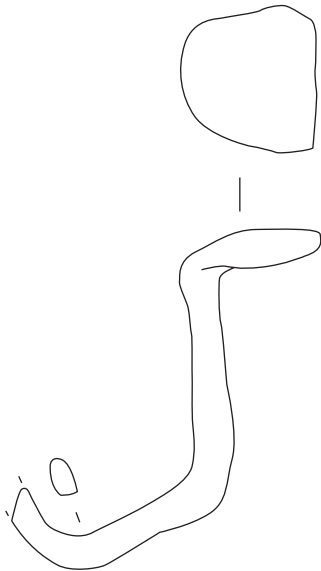

n°1 : 1988-169

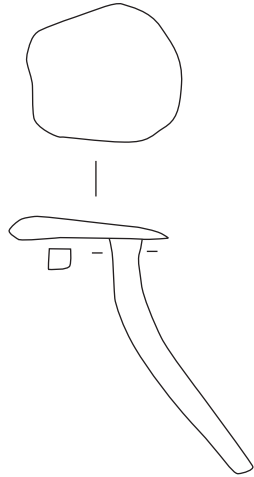

n°2 : 1988-Tr. XI

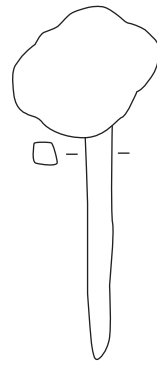

n°3 : 1988-41

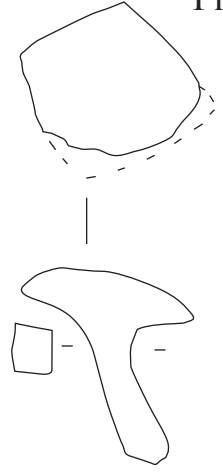

n°4 : VI-CHA 93

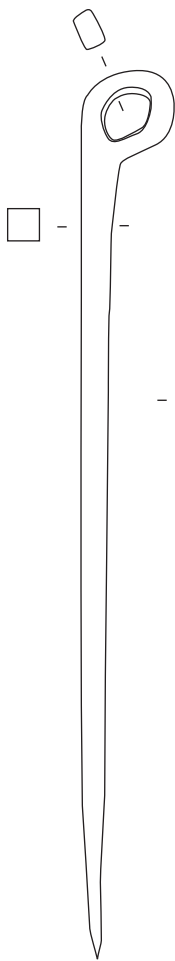

n°7 : 1979-567

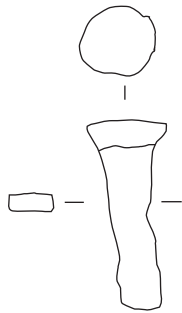

n°5 : 1988-1486



n°6 : 1988-20

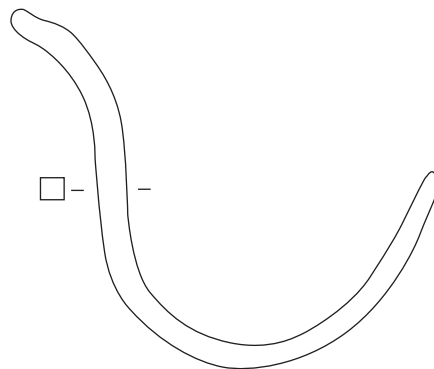

n°8 : 1988-Tr. XI

n°1 à 8 : fer

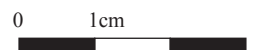

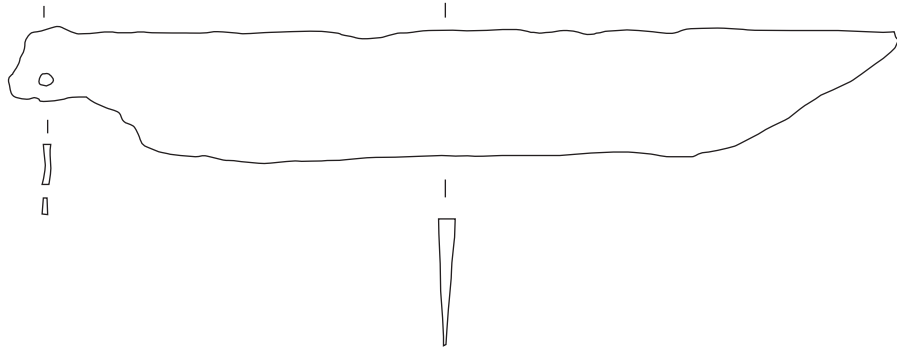

n°1 : 1975-877

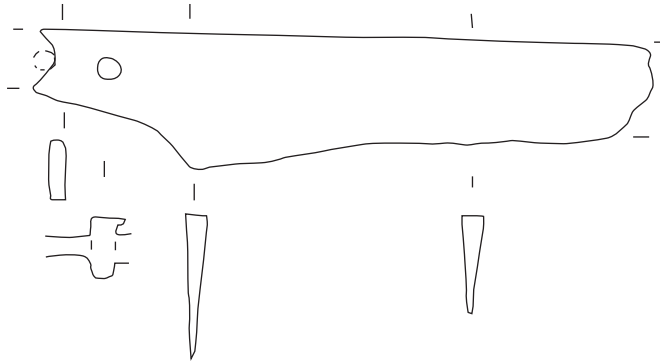

n°2 : 1975-877

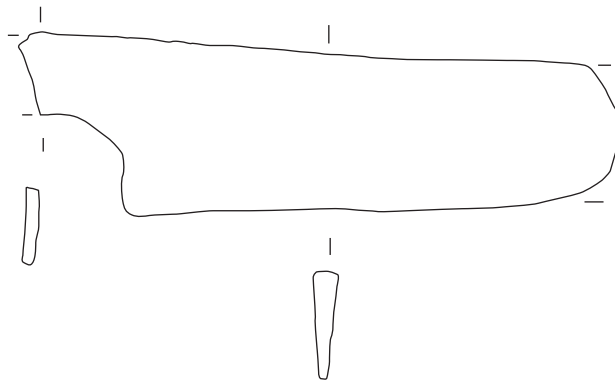

n°3 : VI-CHA 75

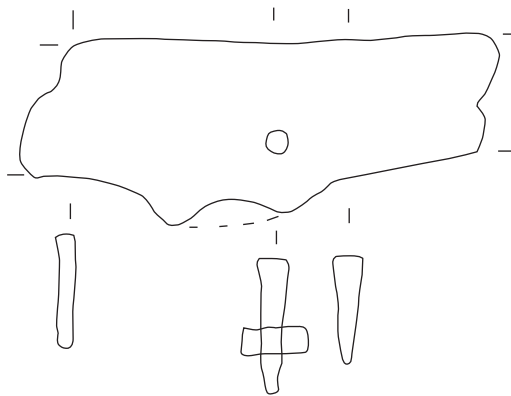

n°4 : VI-CHA 75

n°1 à 4 : fer

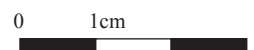

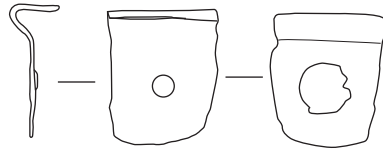

n°1 : 1981-810

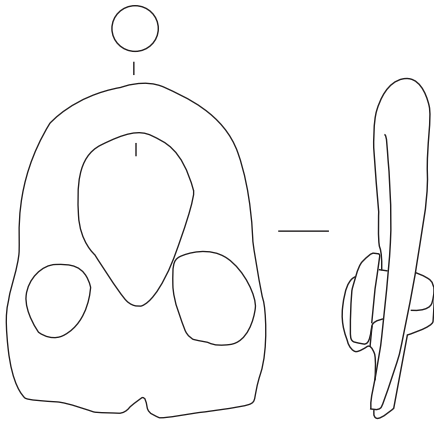

n°2 : 1988-169

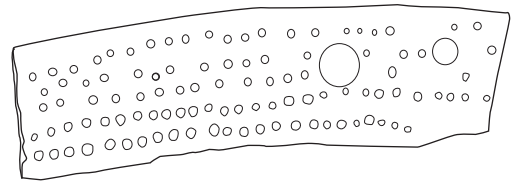
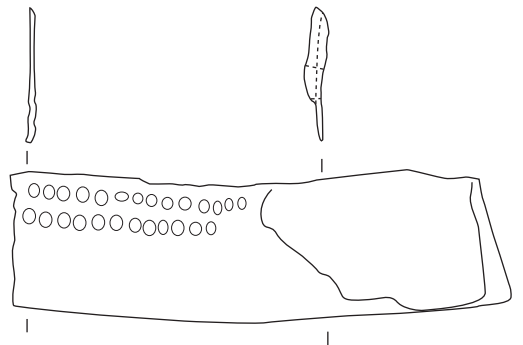

n°3 : 1979-513

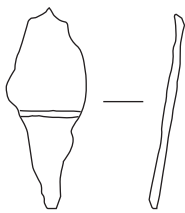

n°4 : 1989-3



n°5 : 1975-894

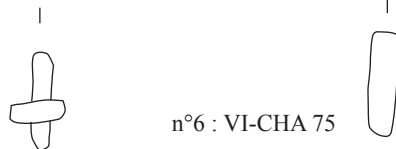
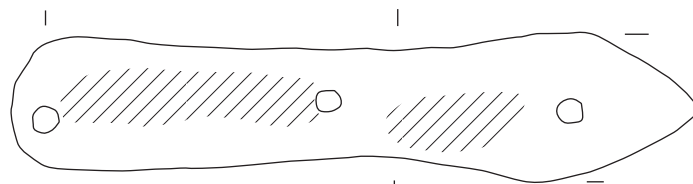

n°6 : VI-CHA 75

n°2-6 : fer sinon bronze

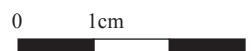

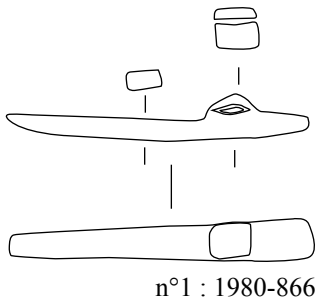

n°1 : 1980-866

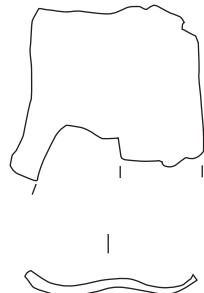

n°2 : 1989-1255

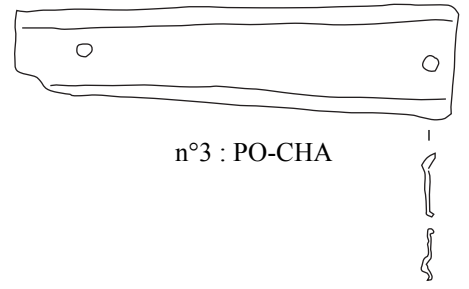

n°3 : PO-CHA

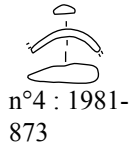

n°4 : 1981-873

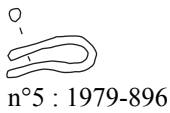

n°5 : 1979-896

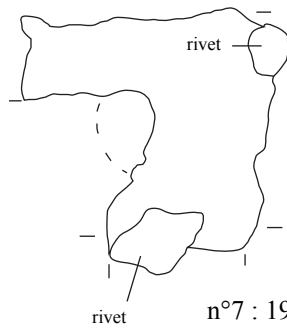

n°7 : 1979-878

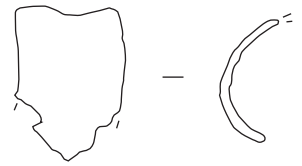

n°8 : 1988-320



n°6 : 1981-889



n°9 : 1979-893

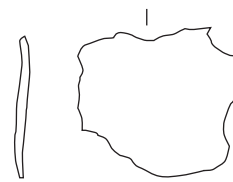

n°10 : 1988

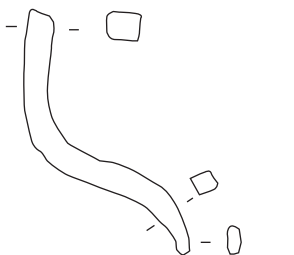

n°11 : 1981-880

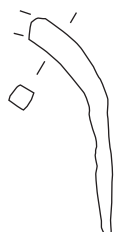

n°12 : 1988-549

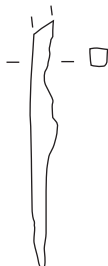

n°13 : 1988-549/2



n°14 : 1981-819

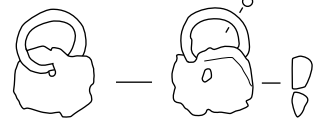

n°15 : 1981-812

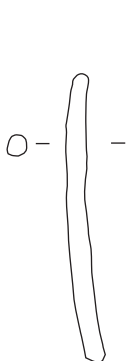

n°16 : 1988-562



n°17 : VI-CHA 93

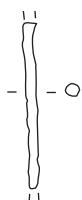

n°18 : 1989-1298



n°19 : 1981-671

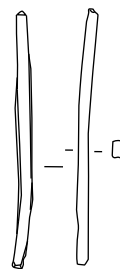

n°20 : 1979-571



brut de fonte  
n°21 : 1981-811

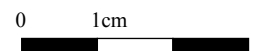

n°1-2-7 à 14 : fer sinon bronze



Chassey  
Le Camp



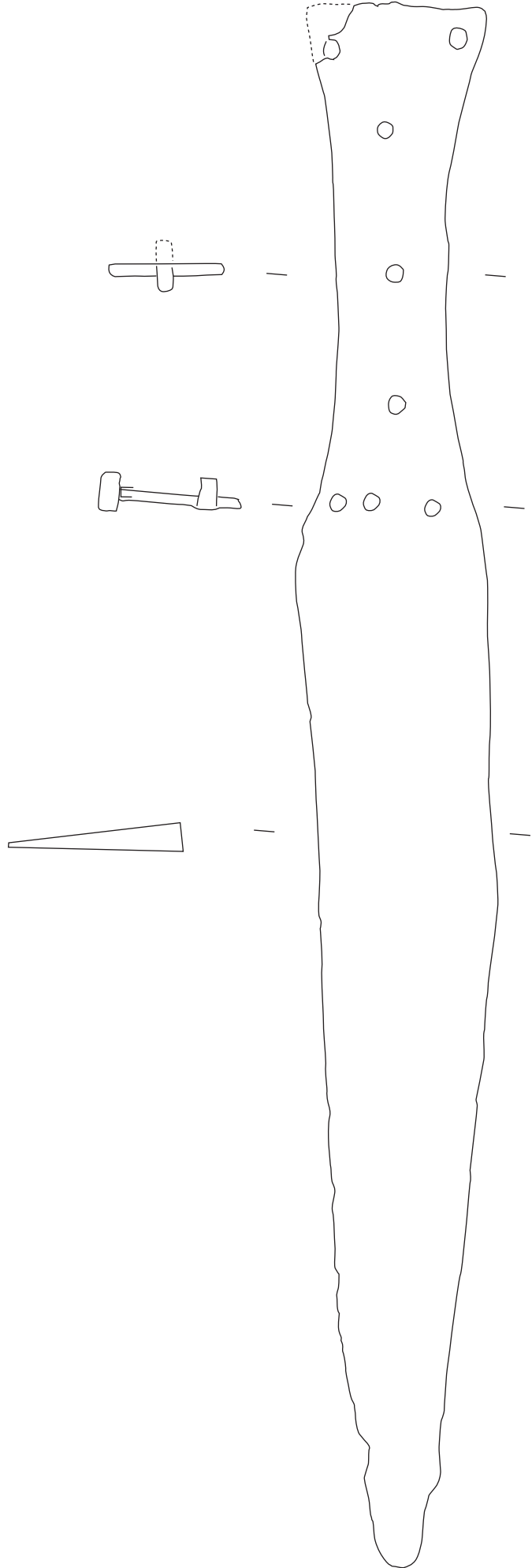

n°1 : fer      n°1-192

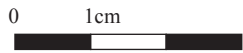

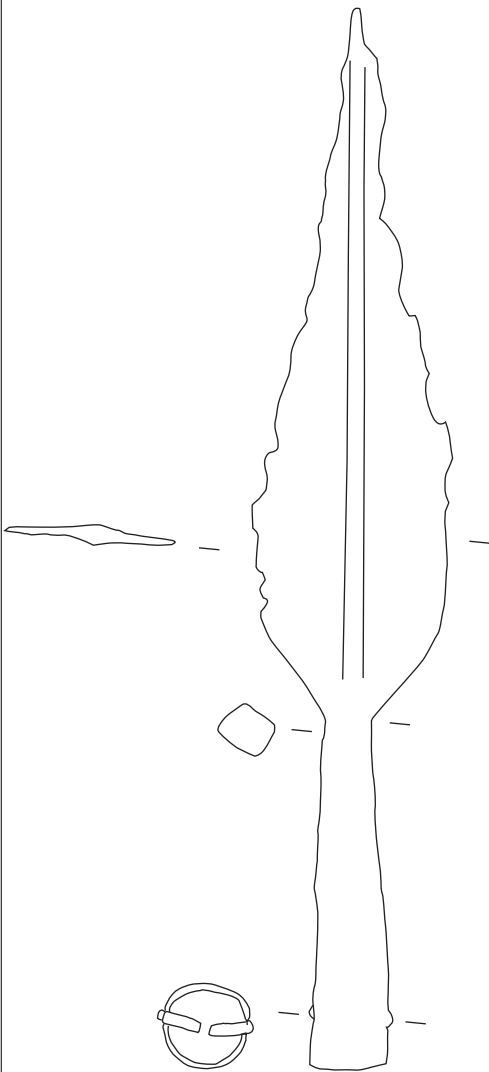

n°1-186

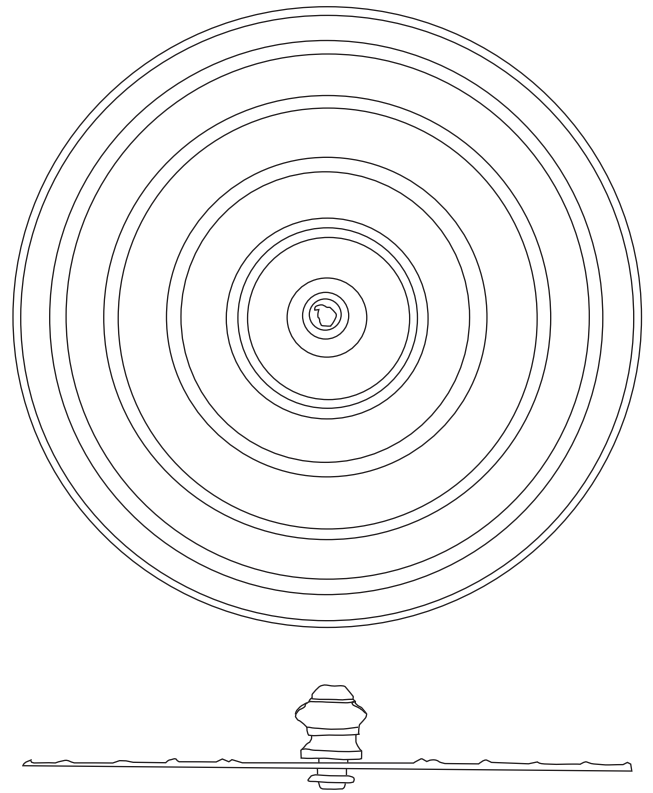

n°2-135

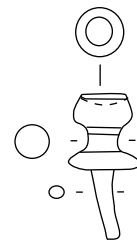

n°3-XLII.52.1



n°4-184a



n°5-184b

n°1-4-5 : fer sinon bronze

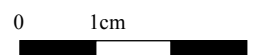

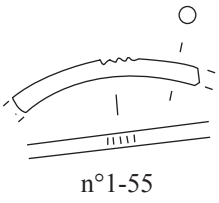

n°1-55

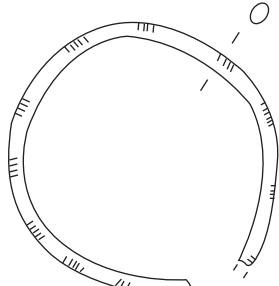

n°3-59

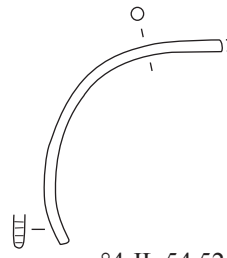

n°4-IL.54.52

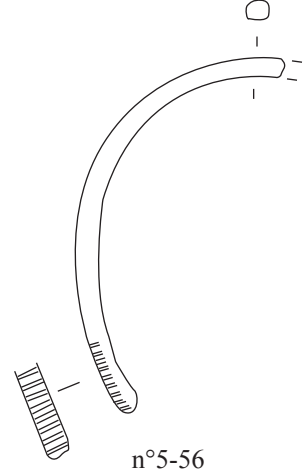

n°5-56

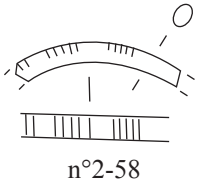

n°2-58

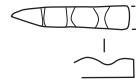

n°6-XLVII.53.198

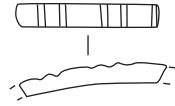

n°7-XLV.53.25

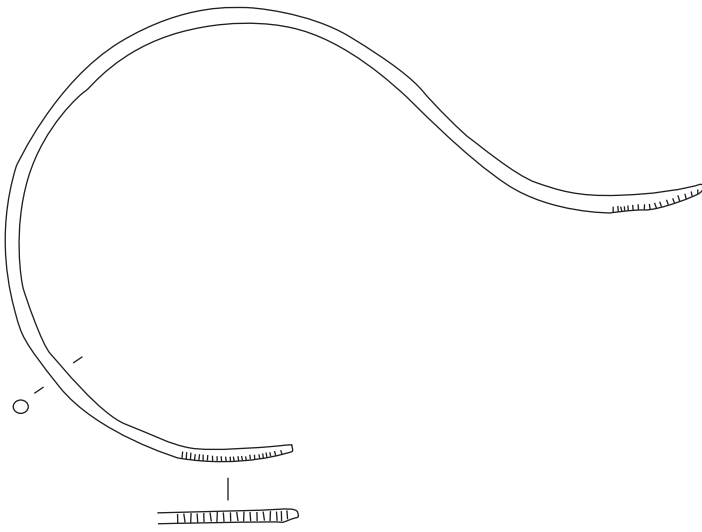

n°9-57

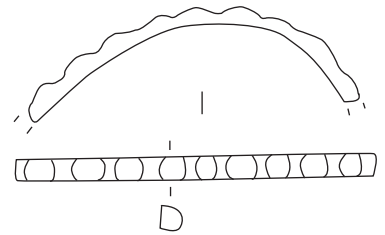

n°8-50

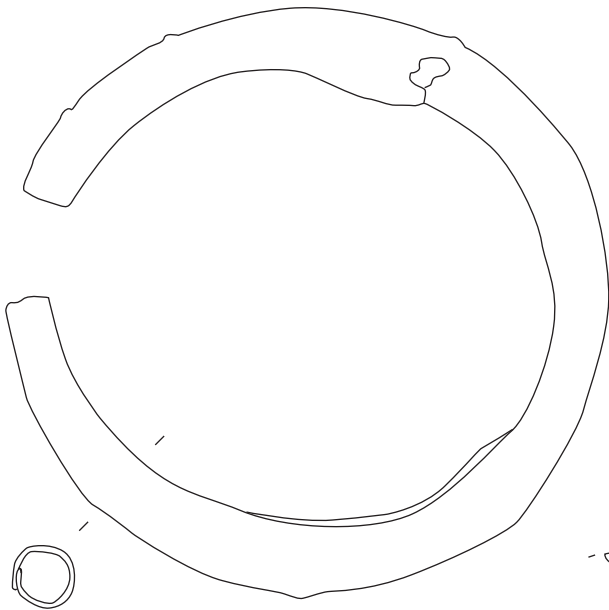

n°10-52

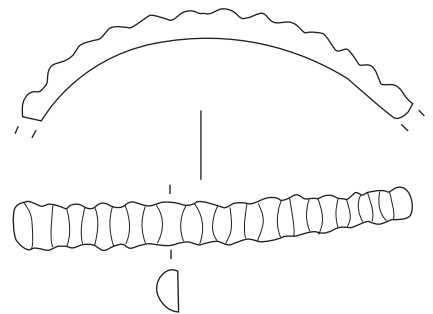

n°11-46

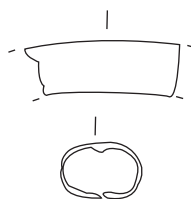

n°13-54

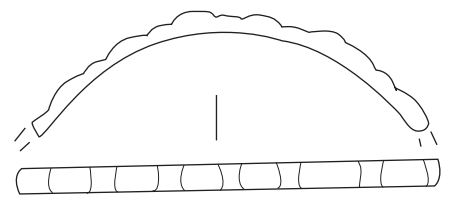

n°12-47

n°1 à 13 : bronze



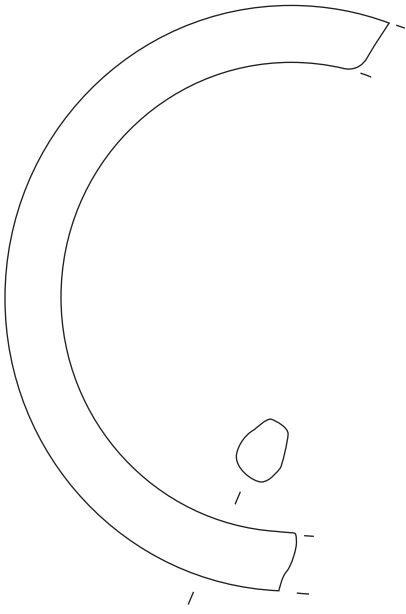

n°1-44



n°2-67

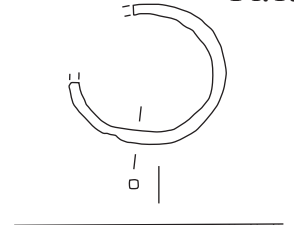

n°4-109

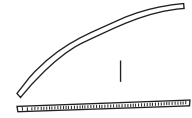

n°5-XLVII.52.56

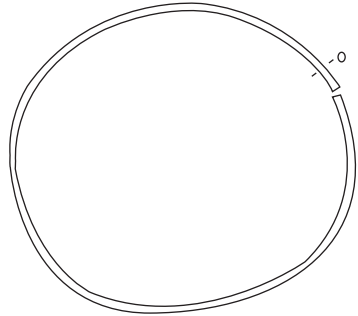

n°3-XLIV.55.64

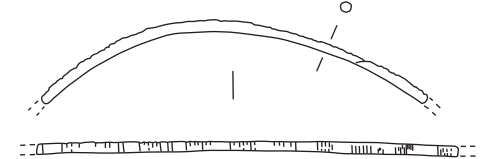

n°6-73

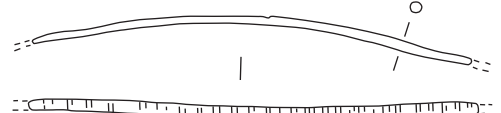

n°7-75

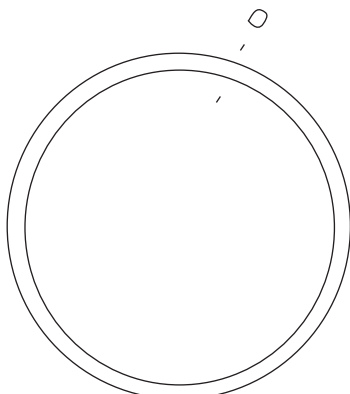

n°8-60

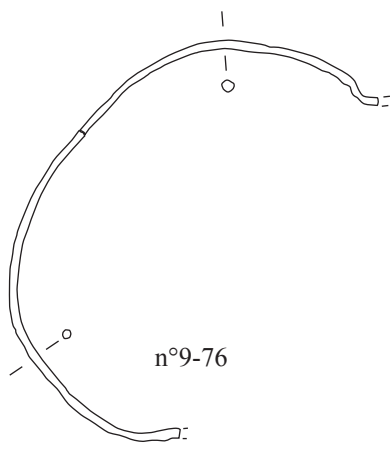

n°9-76

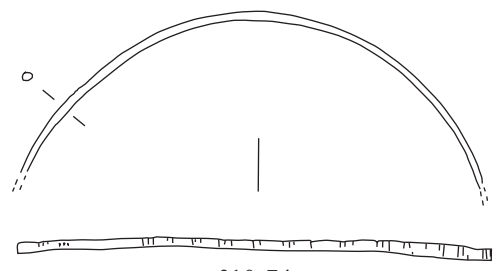

n°10-74

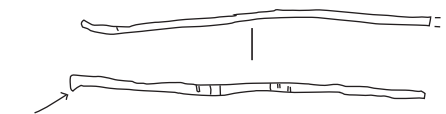

trace de découpe

n°11-138

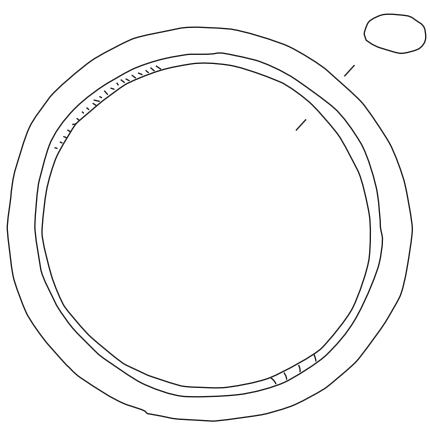

n°12-63

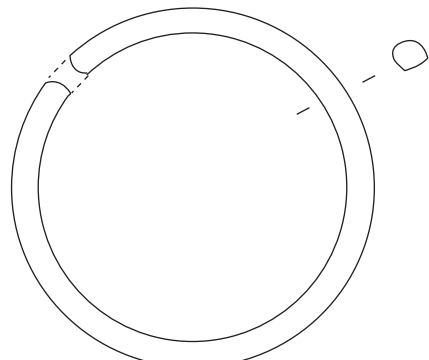

n°13-62

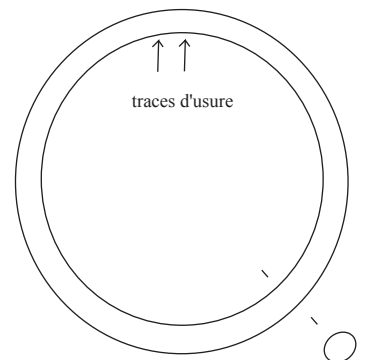

n°14-61

n°1 à 14 : bronze

0 1cm



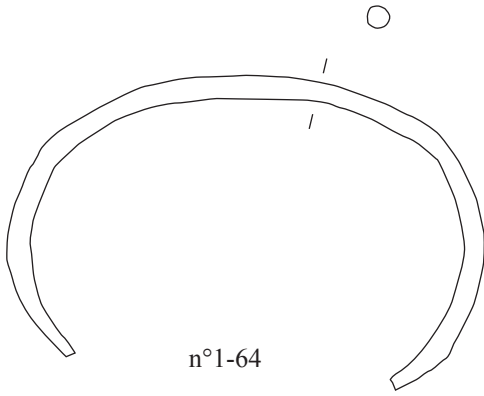

n°1-64

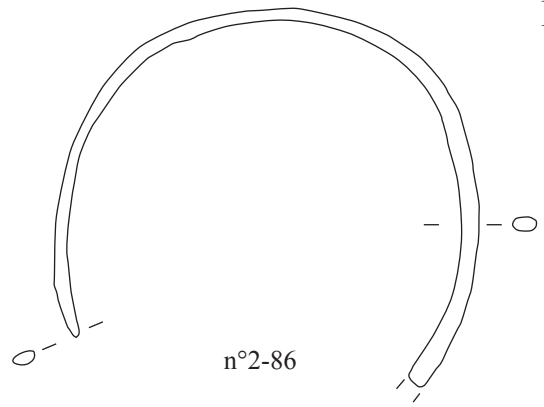

n°2-86

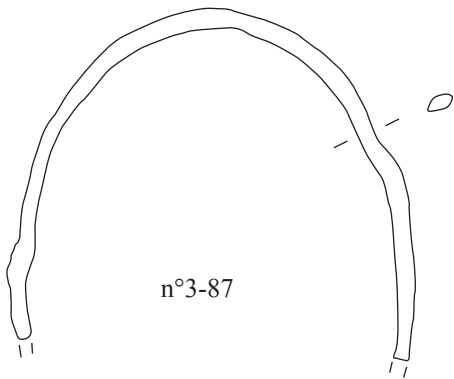

n°3-87

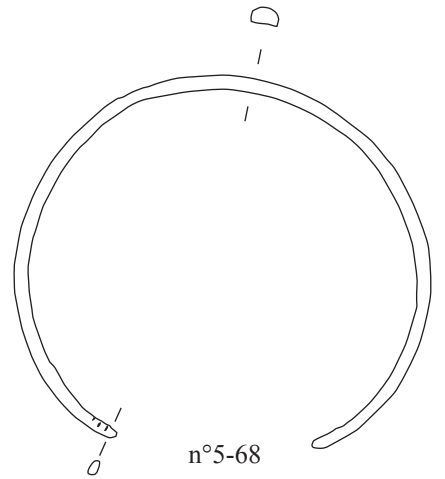

n°5-68

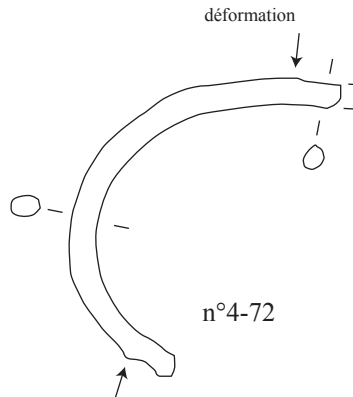

n°4-72

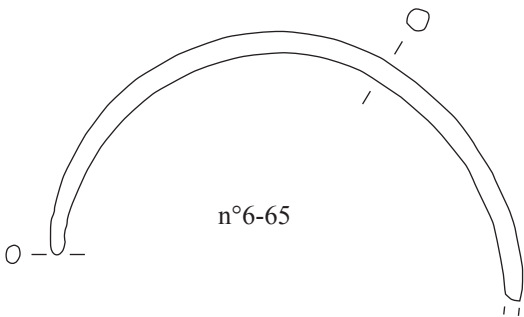

n°6-65

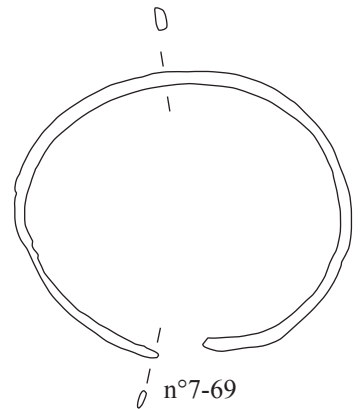

n°7-69

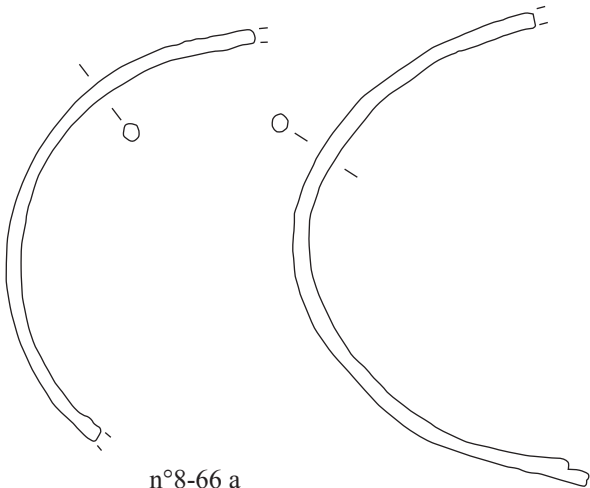

n°8-66 a

n°9-66 c

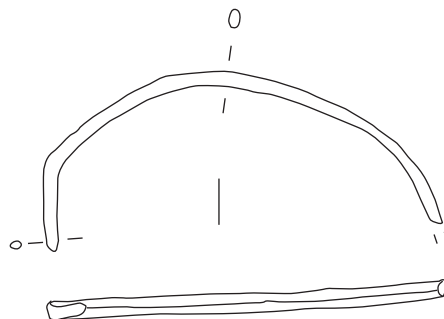

n°10-88

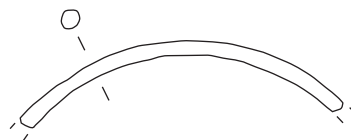

n°11-66 d

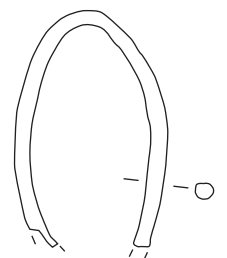

n°12-66 b

n°1 à 12 : bronze

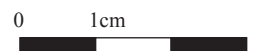

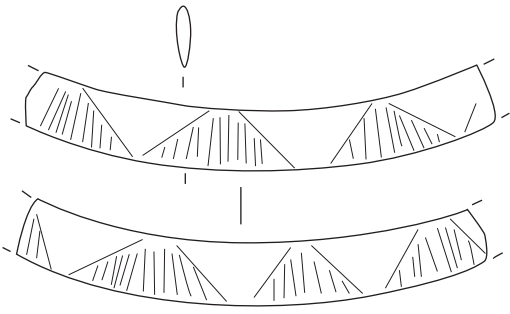

n°1-45

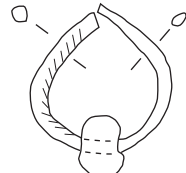

n°4-95

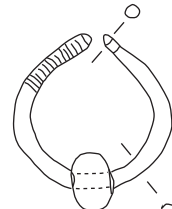

n°5-96

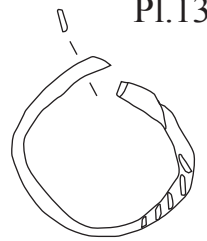

n°6-97

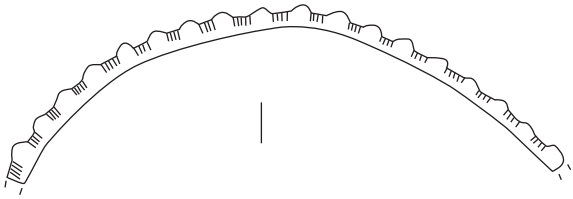

n°2-48

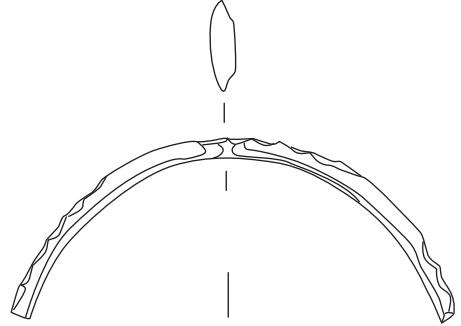

n°7-49

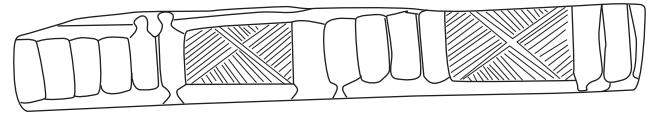

d'après Thevenot



n°3-51

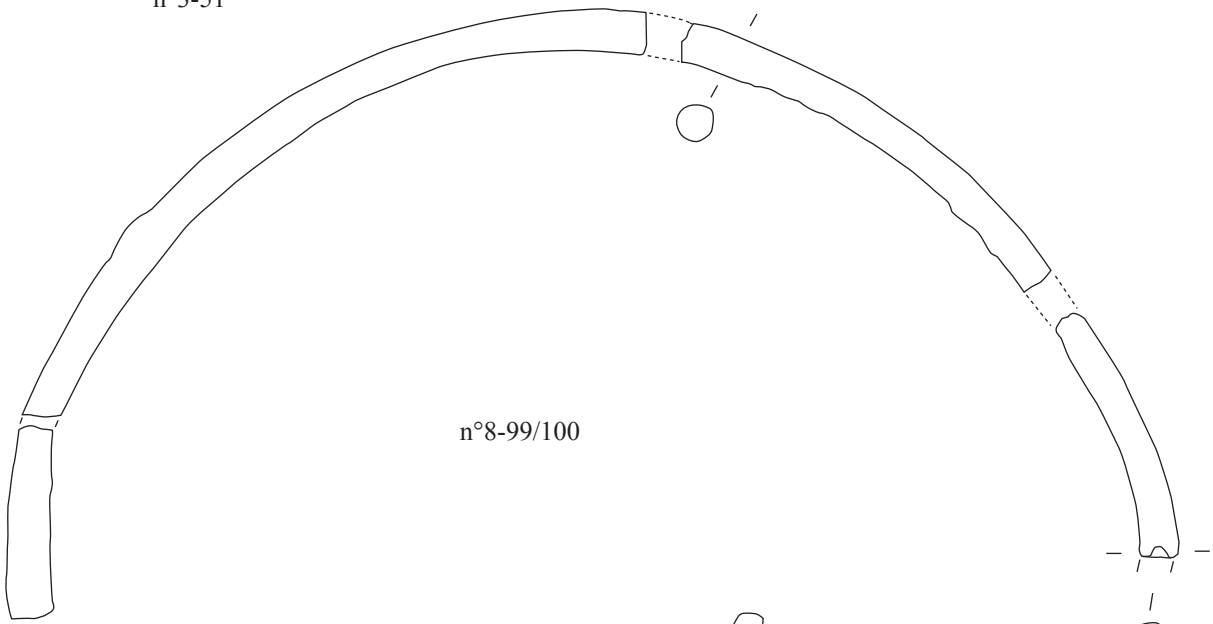

n°8-99/100

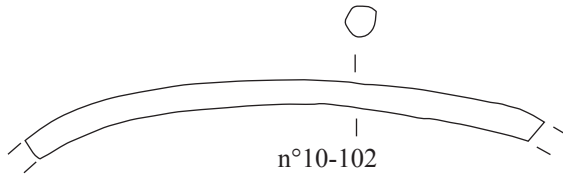

n°10-102

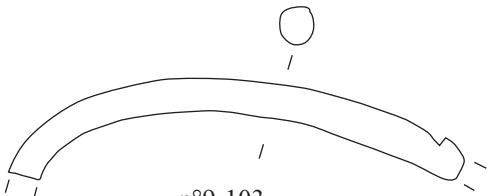

n°9-103

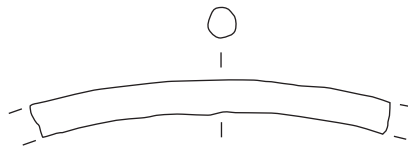

n°11-101



n°12-111

n°1 à 12 : bronze

0 1cm





n°1 : 119  
d'après Thevenot

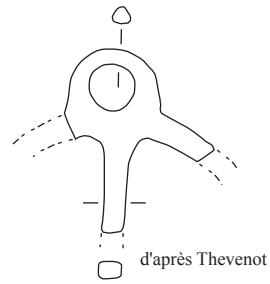

n°2 : 122  
d'après Thevenot

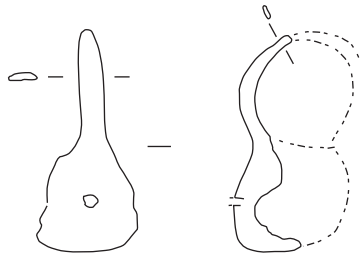

n°3 : 121

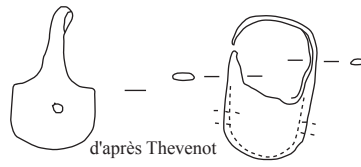

n°4 : 120  
d'après Thevenot

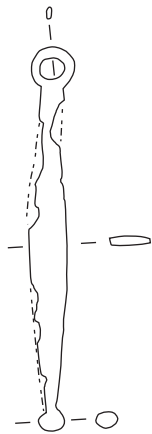

n°5 : 129

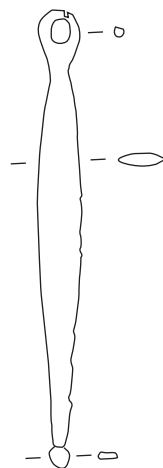

n°6 : 128

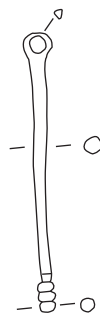

n°7 : 130

n°1 à 4-7 : bronze ; n°5-6 : fer



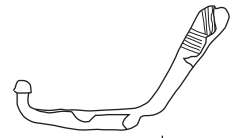

n°1-25

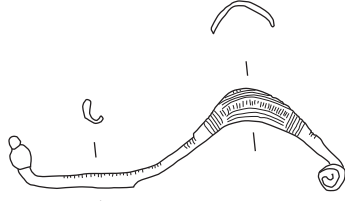

n°2-22

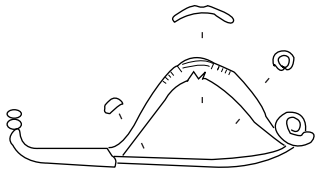

D'après Thevenot

n°3-23

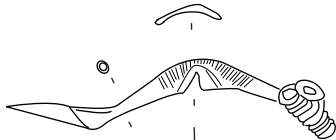

D'après Thevenot

n°4-24

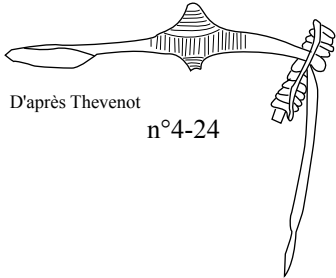

n°12-37

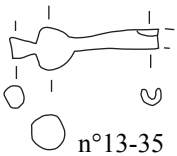

n°13-35

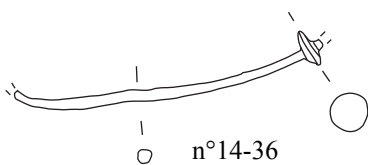

n°14-36

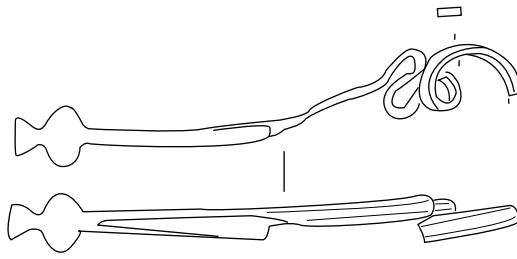

D'après Thevenot

n°8-29

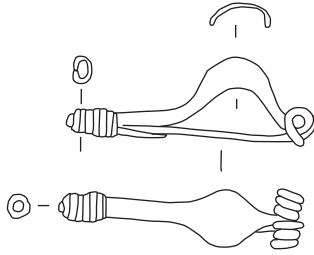

n°5-12

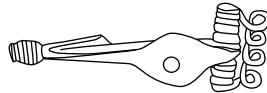

n°6-IL.53.12

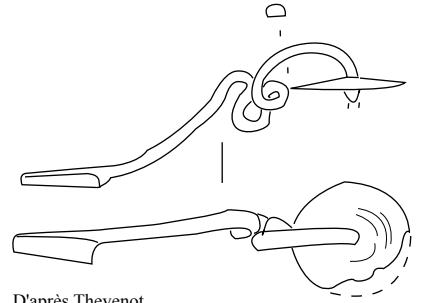

D'après Thevenot

n°9-30

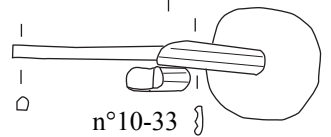
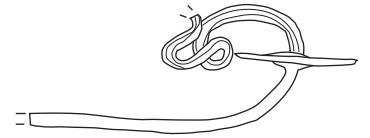

n°10-33

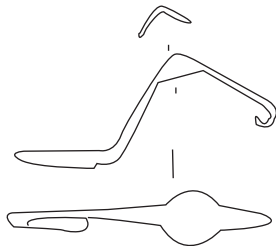

D'après Thevenot

n°7-19

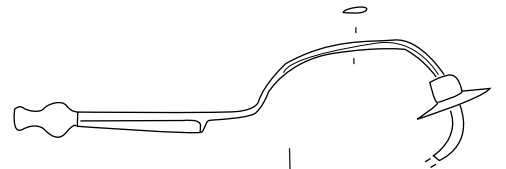

D'après Thevenot

n°11-31

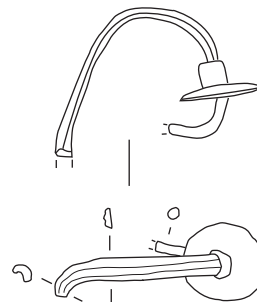

n°15-34

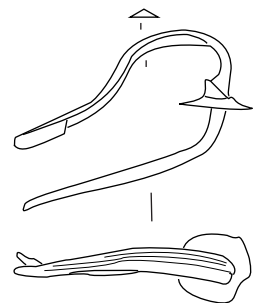

D'après Thevenot

n°16-32

n°1 à 16 : bronze

0 1cm





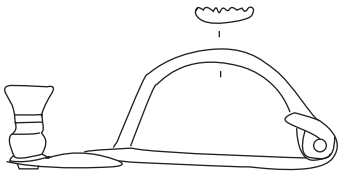

D'après Thevenot

n°1 -14

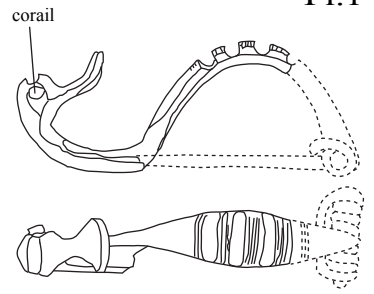
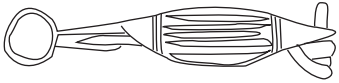

d'après Thevenot

n°4-17

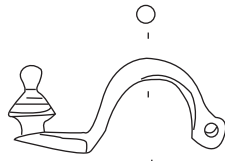

D'après Thevenot

n°3-16

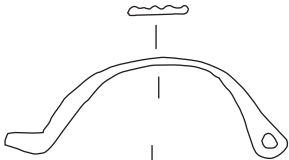

n°2-15

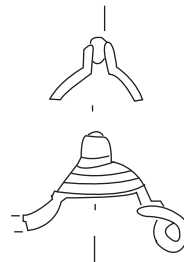
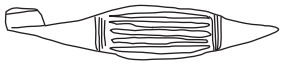

D'après Thevenot

n°5-20

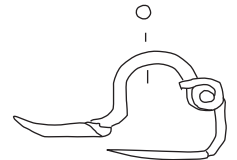
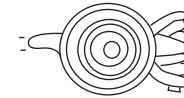

D'après Thevenot

n°6-26

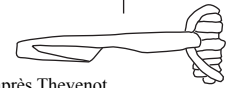

n°7-09/XLV-53.2

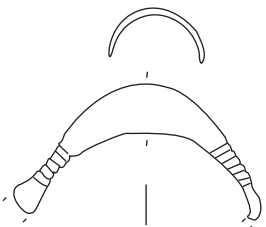
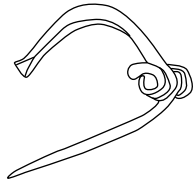
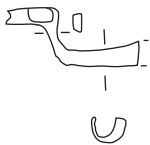

D'après Thevenot

n°9-28

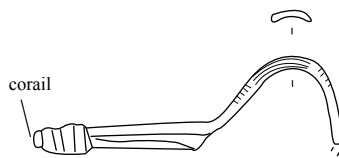
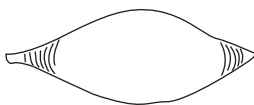

D'après Thevenot

n°8-21

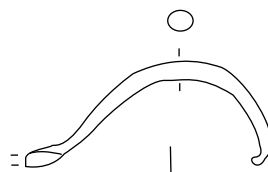

D'après Thevenot

n°10-27

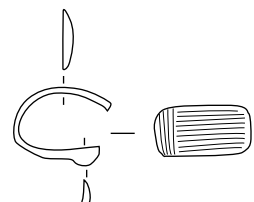
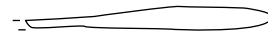

n°11-L.54.190

0 1cm

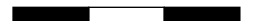

n°1 à 11 : bronze

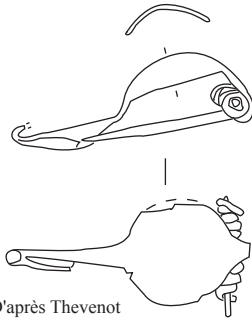

D'après Thevenot

n°1 : 05

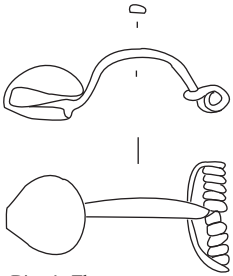

D'après Thevenot

n°2 : 02

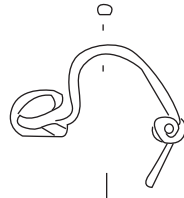

D'après Thevenot

n°5 : 07

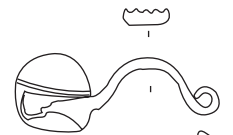

D'après Thevenot

n°3 : 03

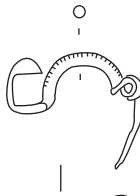

D'après Thevenot

n°6 : 08

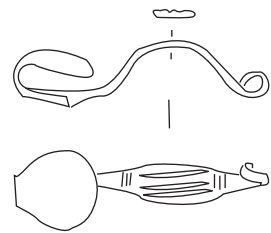

D'après Thevenot

n°4 : 04

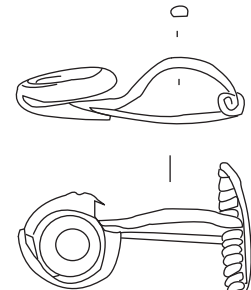

D'après Thevenot

n°7 : 06

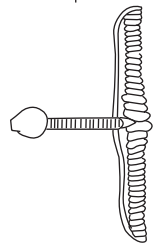

n°10 : 12

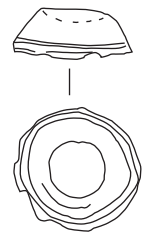

n°8 : 10



n°9 : 11



n°11 : XLV.53.63

n°1 à 11 : bronze

0 1cm

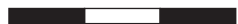

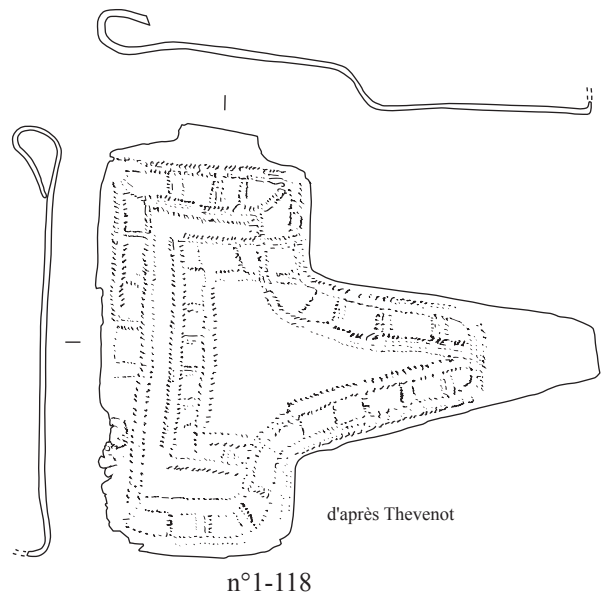

n°1-118

d'après Thevenot

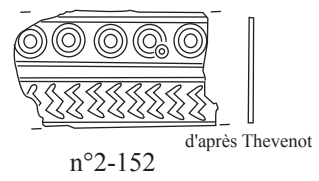

n°2-152

d'après Thevenot

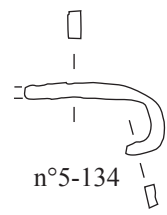

n°5-134



n°3-132

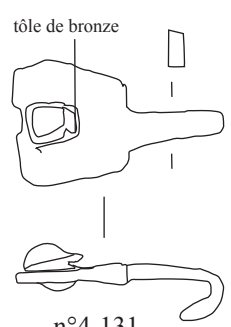

n°4-131

tôle de bronze

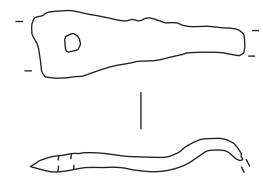

n°6-133

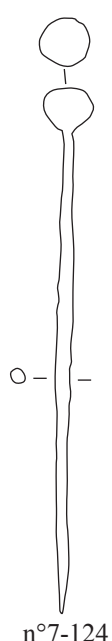

n°7-124

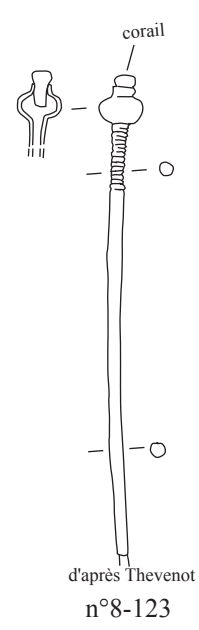

n°8-123

d'après Thevenot

corail

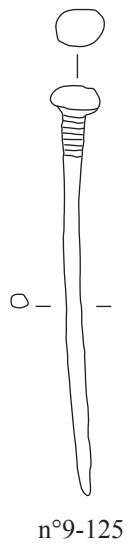

n°9-125



n°10-126

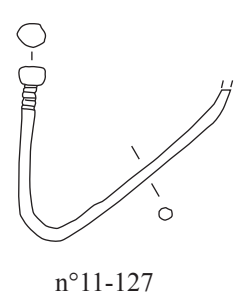

n°11-127

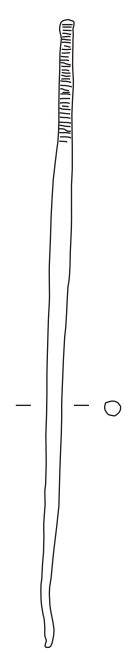

n°12-146

n°1-2-6 à 12 : bronze sinon fer

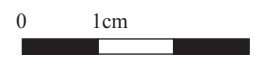

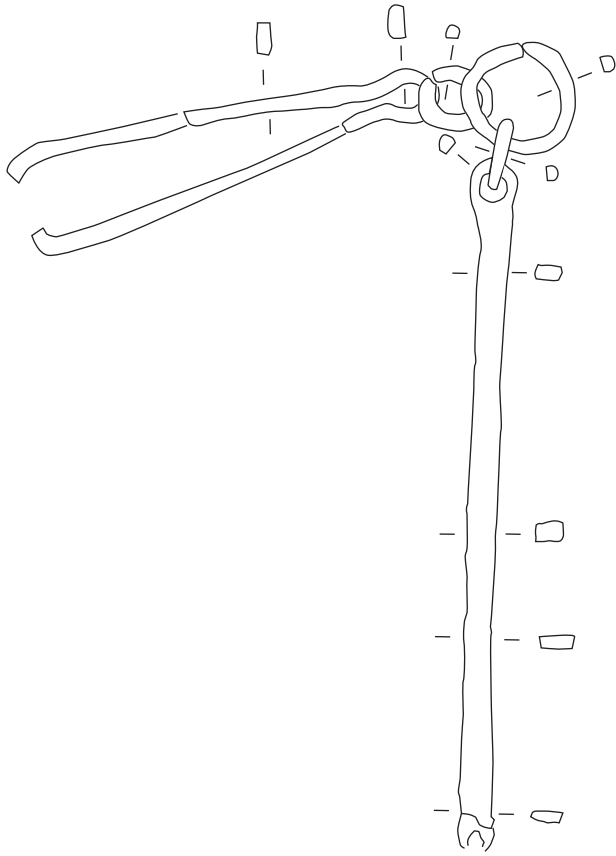

n°1-113

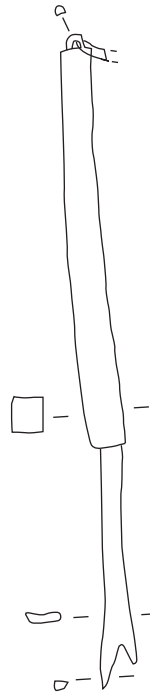

n°2-116

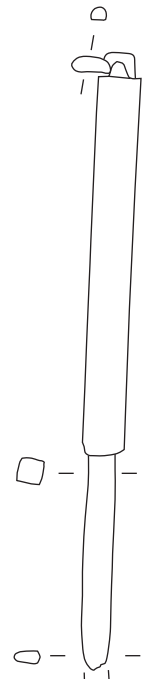

n°3-117

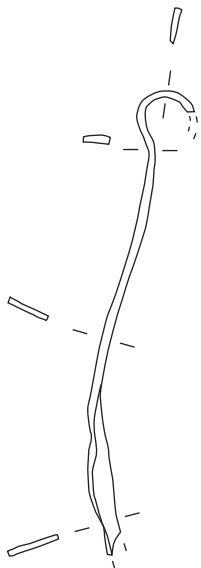

n°4-114

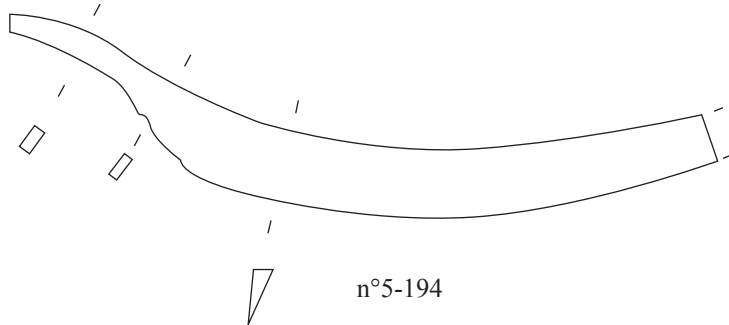

n°5-194

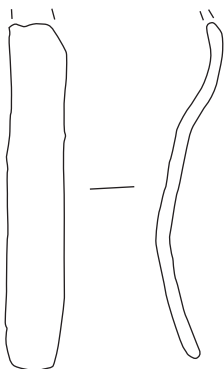

n°6-115

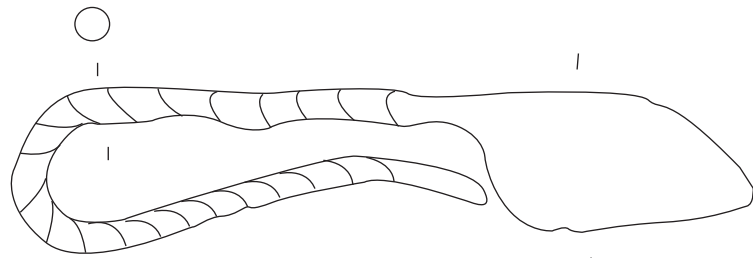

n°7-197

n°1 à 3-5-7 : fer ; n°4-6 : bronze

0 1cm

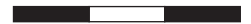

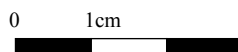
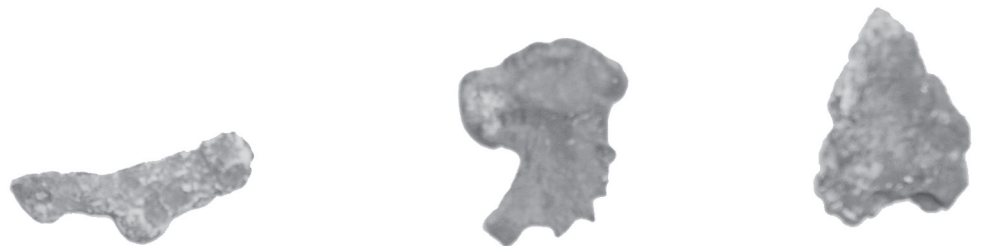
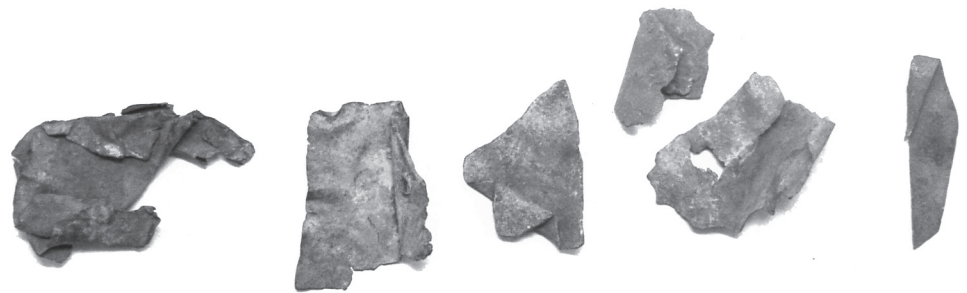
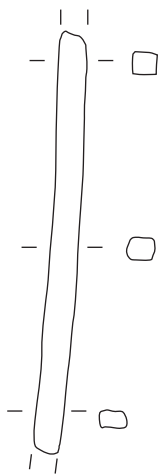
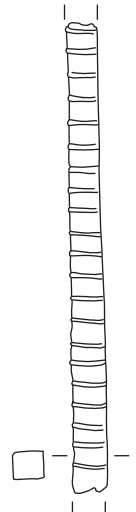
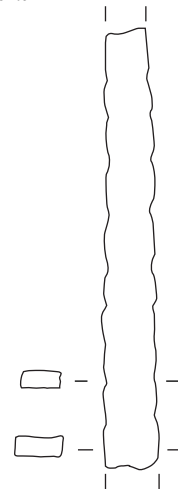
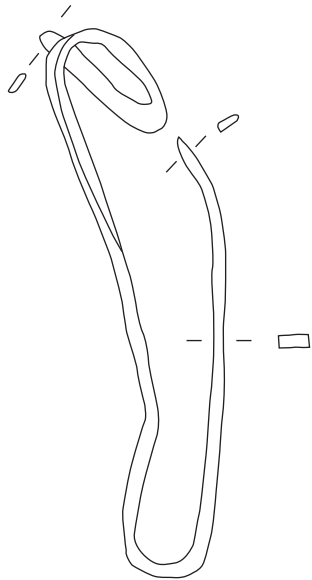
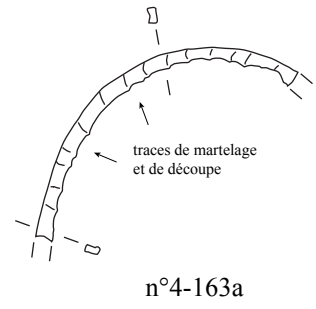
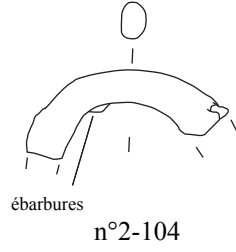
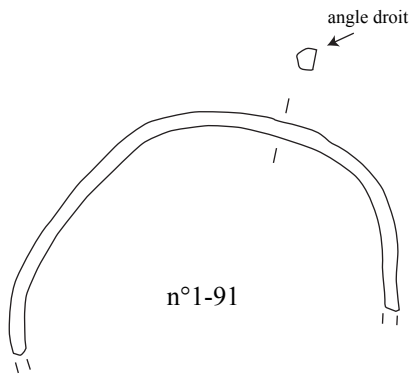

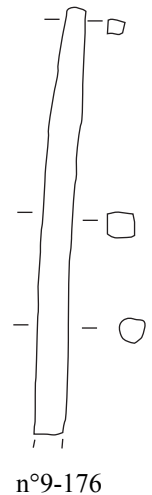
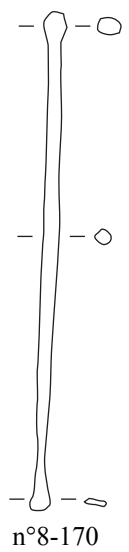
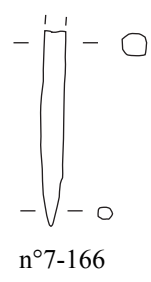
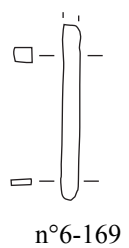
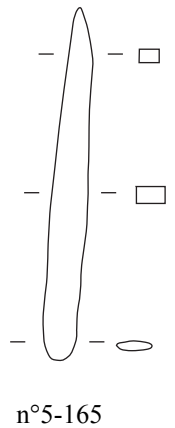
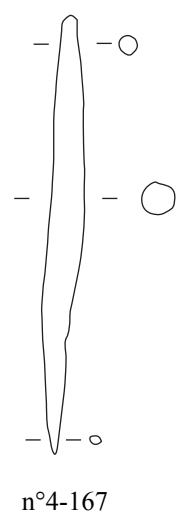
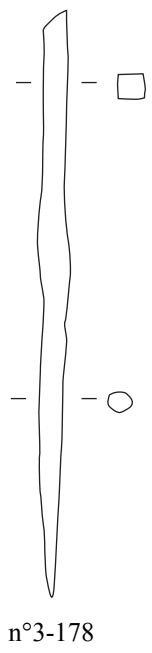
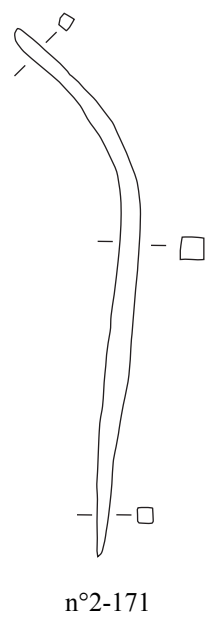
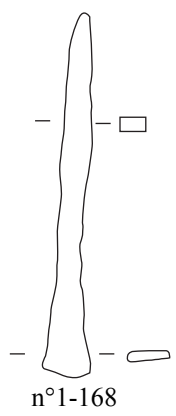

n°1-3-5 : fer sinon fer

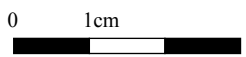

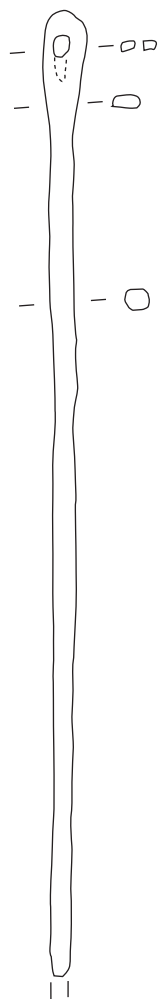

n°1-144a

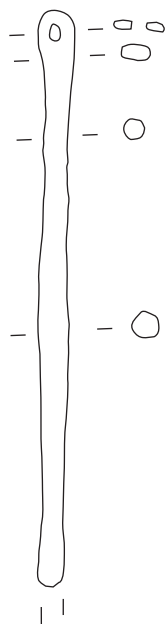

n°2-144b

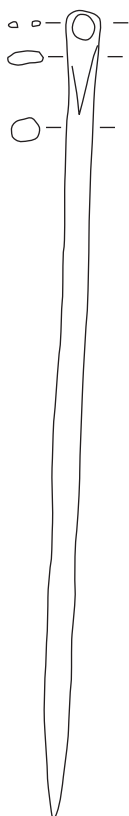

n°4-142

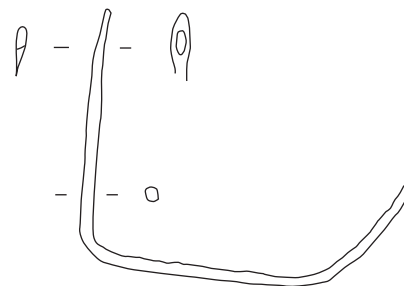

n°5-140c

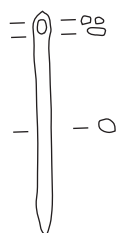

n°3-143a



n°6-145

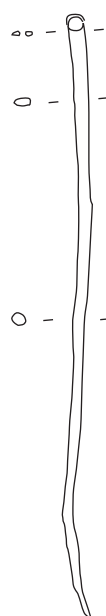

n°7-141e

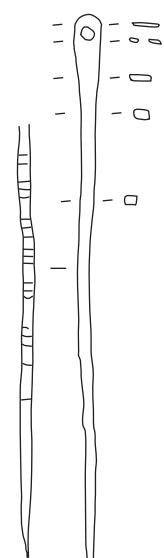

n°8-141b

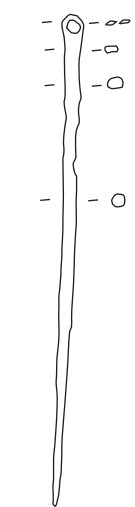

n°9-141a

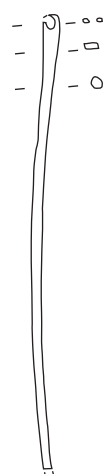

n°10-141d

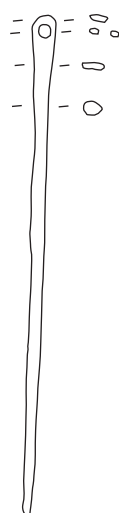

n°11-141c

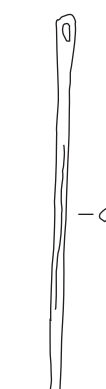

n°12-143b

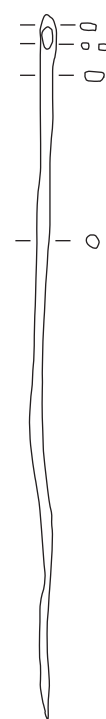

n°13-143c

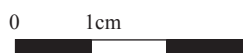

n°1-2 : fer ; n°3 à 13 : bronze

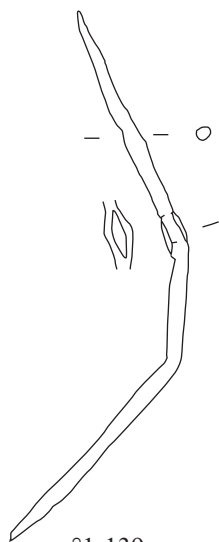

n°1-139a



n°2-139b

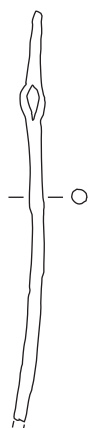

n°3-139d



n°4-139c

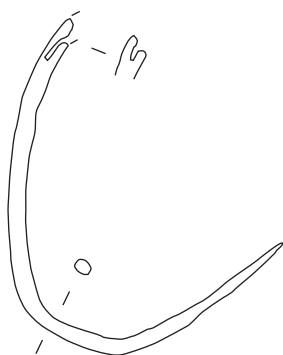

n°5-145b

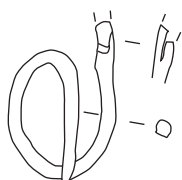

n°6-145c

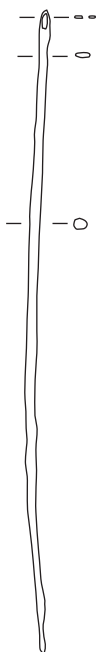

n°9-143d

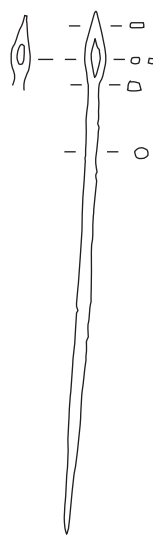

n°7-140a

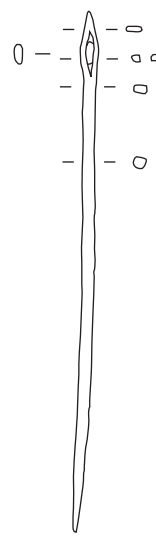

n°8-140b

n°1 à 9 : bronze

0 1cm







n°1-157



n°2-158

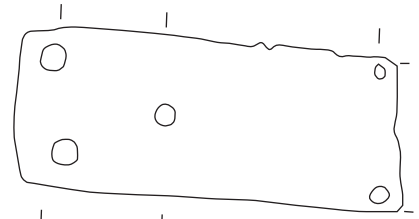

n°3-155

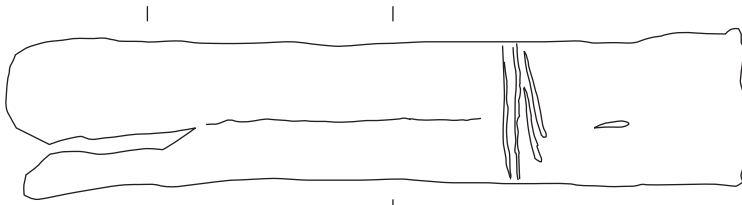
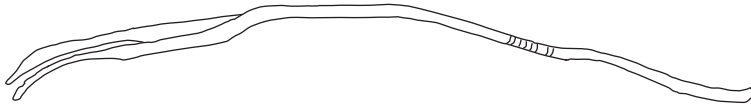
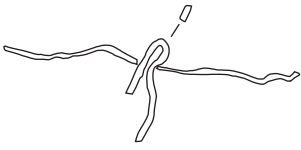

n°4-156

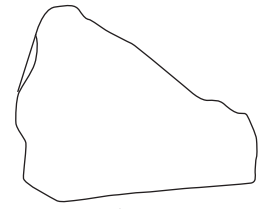

n°5-XLVII.55.35

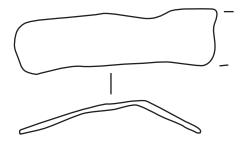
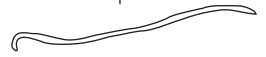

n°8-XLVIII.55.95

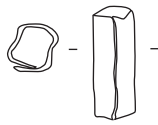

n°6-XLVIII.55.128

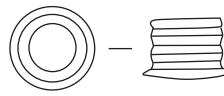

n°7-XLVIII.53.49

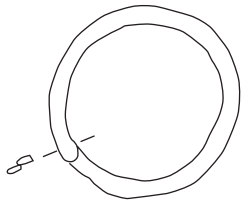

n°9-107a



n°10-107b

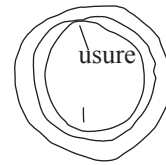

n°11-106



n°12-110

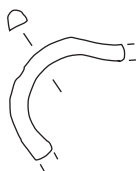

n°13-108

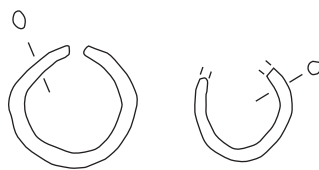

n°14-98

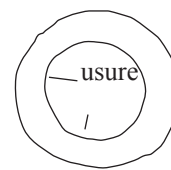

n°15-105

n°1-2-4-6 à 15 : bronze sinon fer

0 1cm



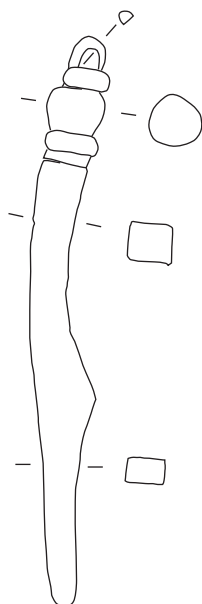
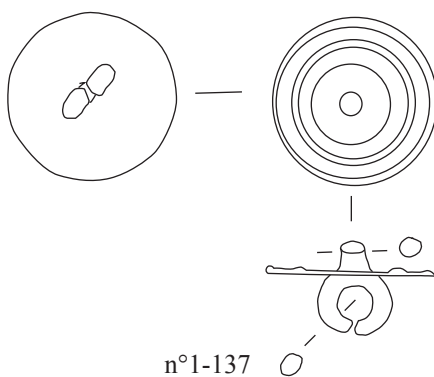

n°1 : bronze ; n°2 : fer

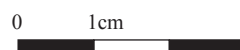



Vix  
Mont Lassois

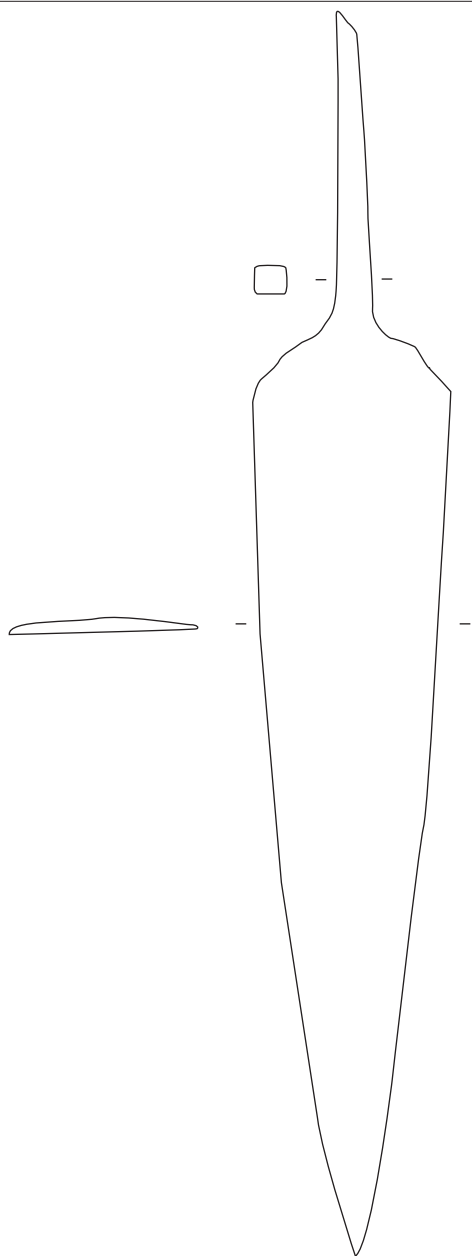

n°1 : 1077

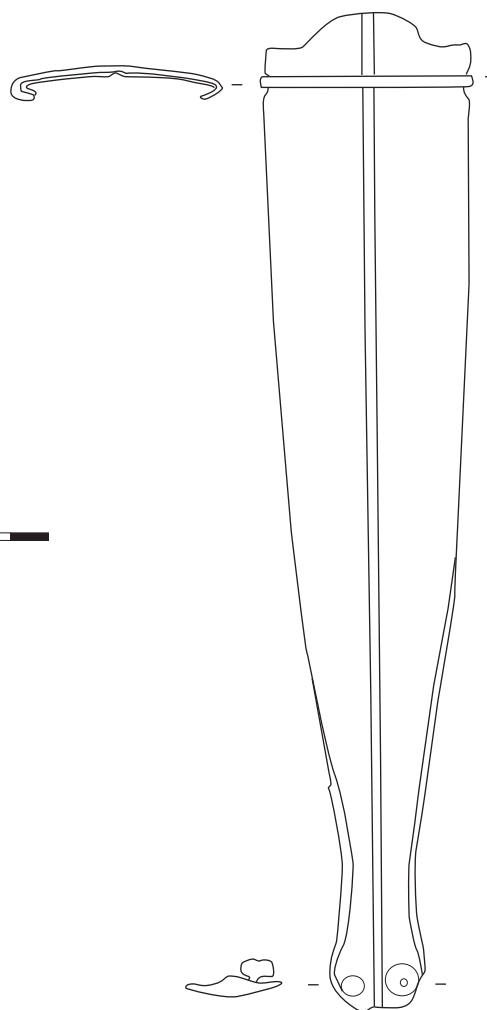

n°2 : 1078

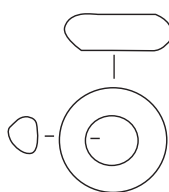

n°3 : 639

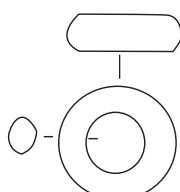

n°4 : 640

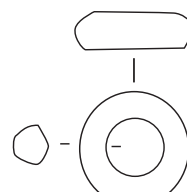

n°5 : 641

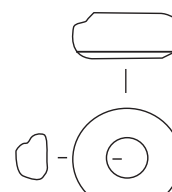

n°6 : 642

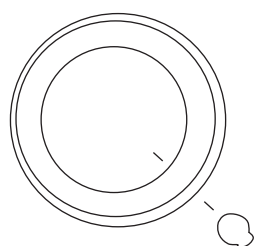

n°7 : 681

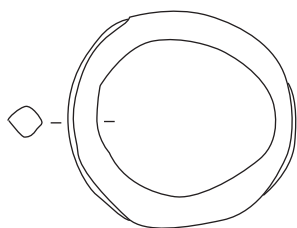

n°8 : 682

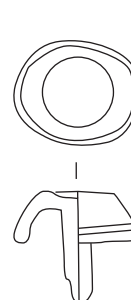

n°9 : 786

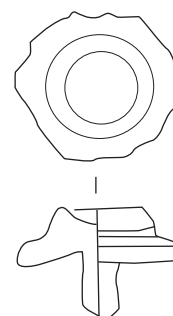

n°10 : 787

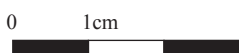

n°1 : fer sinon bronze

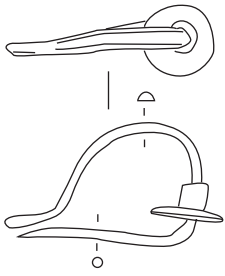

n°1 : 1

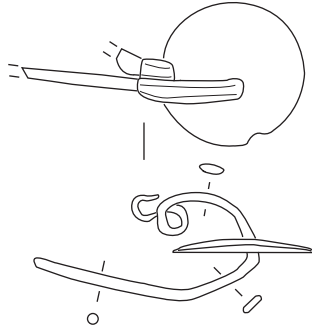

n°2 : 2

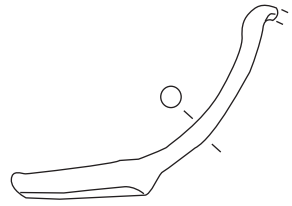

n°3 : 3

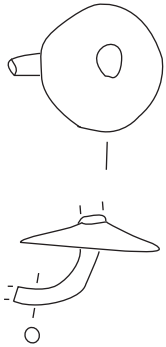

n°4 : 4



n°5 : 5

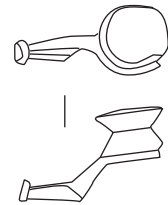

n°6 : 7

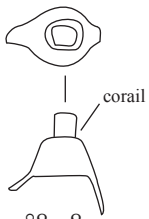

n°8 : 8

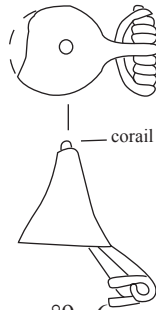

n°9 : 6

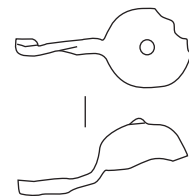

n°10 : 183

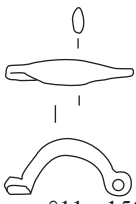

n°11 : 150

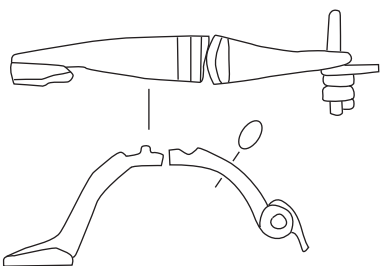

n°12 : 181/145

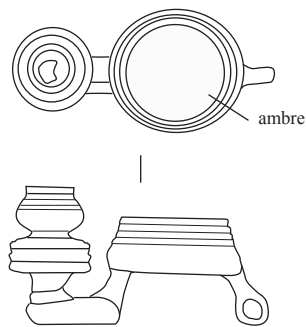

n°13 : 116

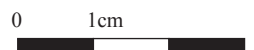

n°1 à 13 : bronze

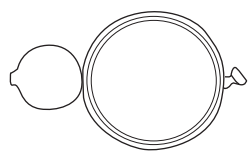

n°1 : 29



n°5 : 18

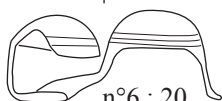

n°6 : 20



n°10 : 212



n°2 : 35

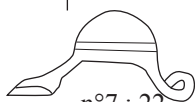

n°7 : 22



n°11 : 34



n°3 : 36

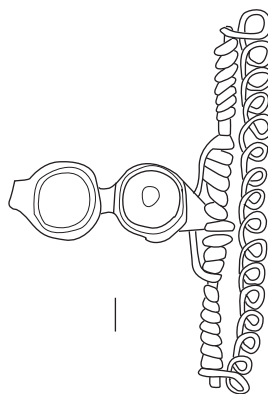

n°8 : 9

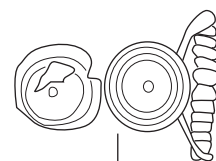

n°12 : 11

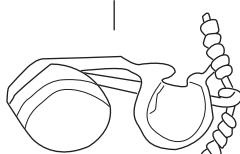

n°4 : 12



n°9 : 17

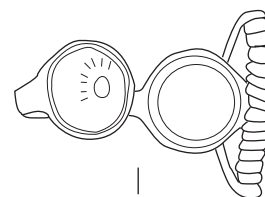

n°13 : 15

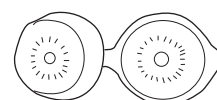

n°15 : 19

n°1 à 15 : bronze

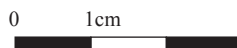

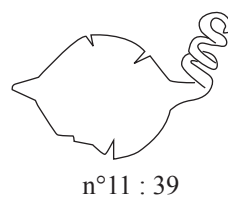
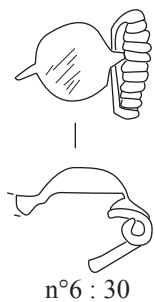
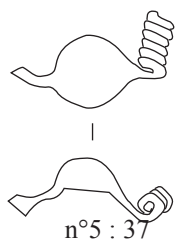
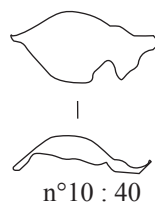
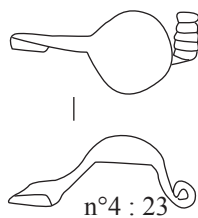
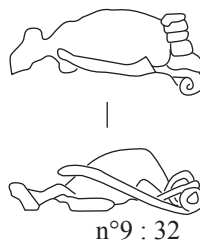
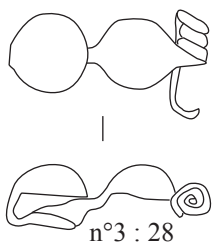
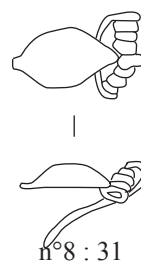
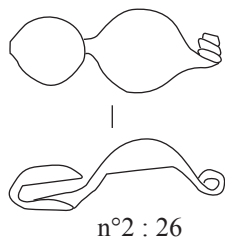
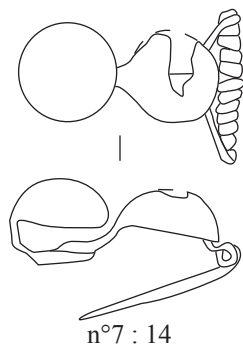
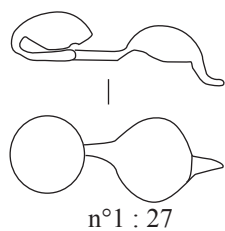

n°1 à 11 : bronze

0 1cm



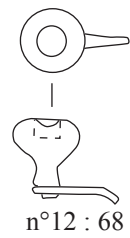
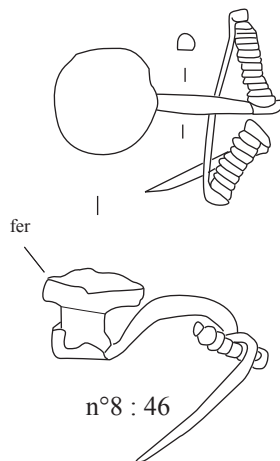
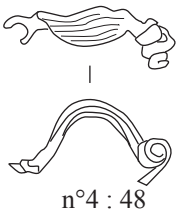
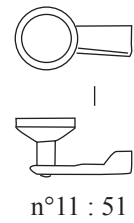
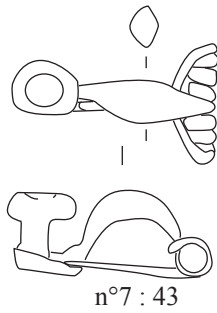
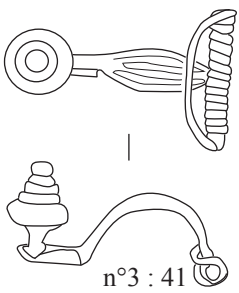
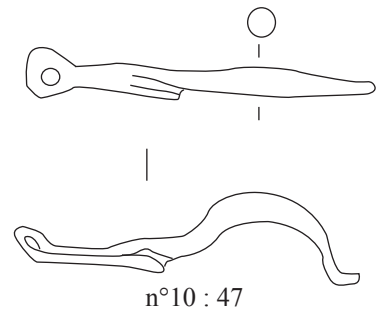
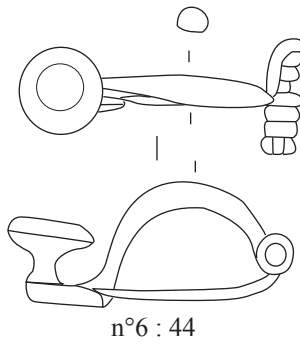
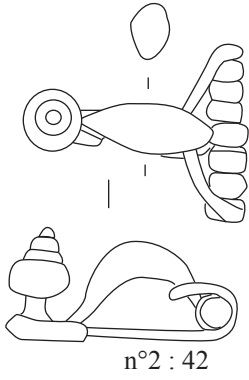
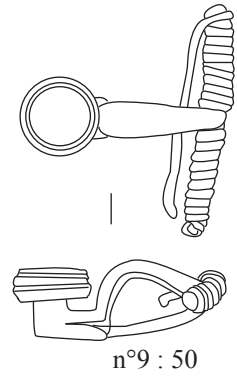
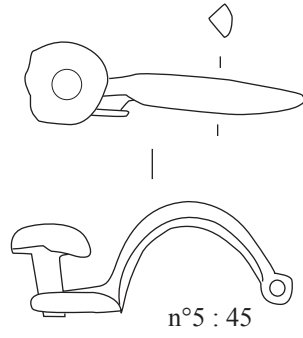
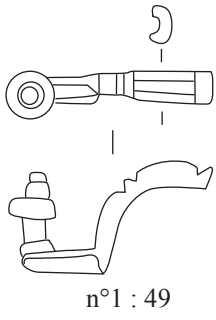

n°1 à 12 : bronze



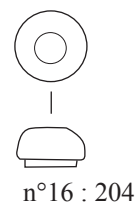
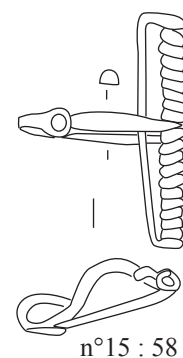
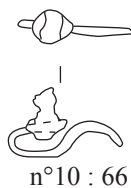
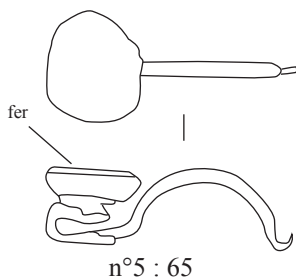
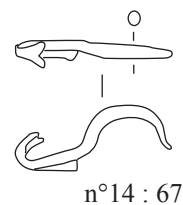
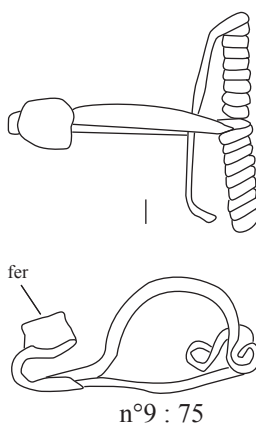
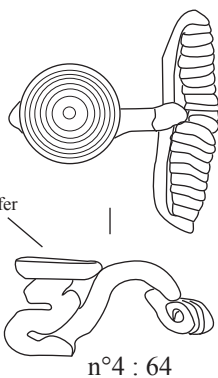
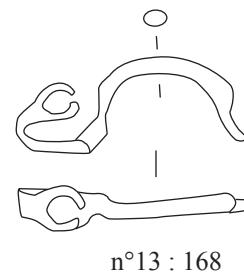
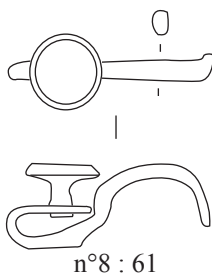
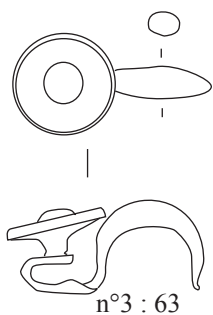
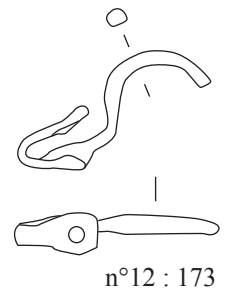
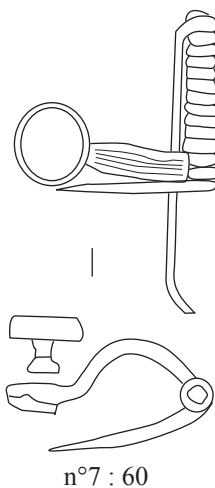
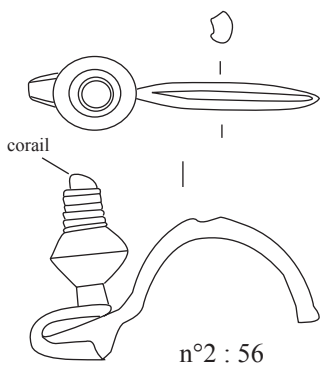
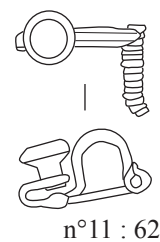
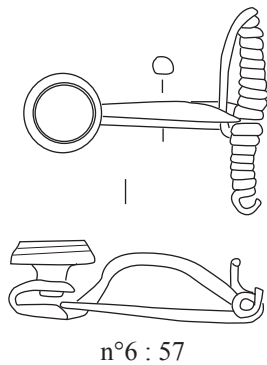
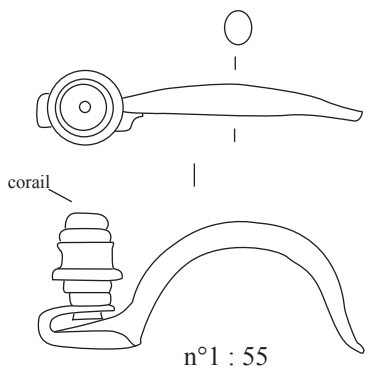

n°1 à 16 : bronze

0 1cm



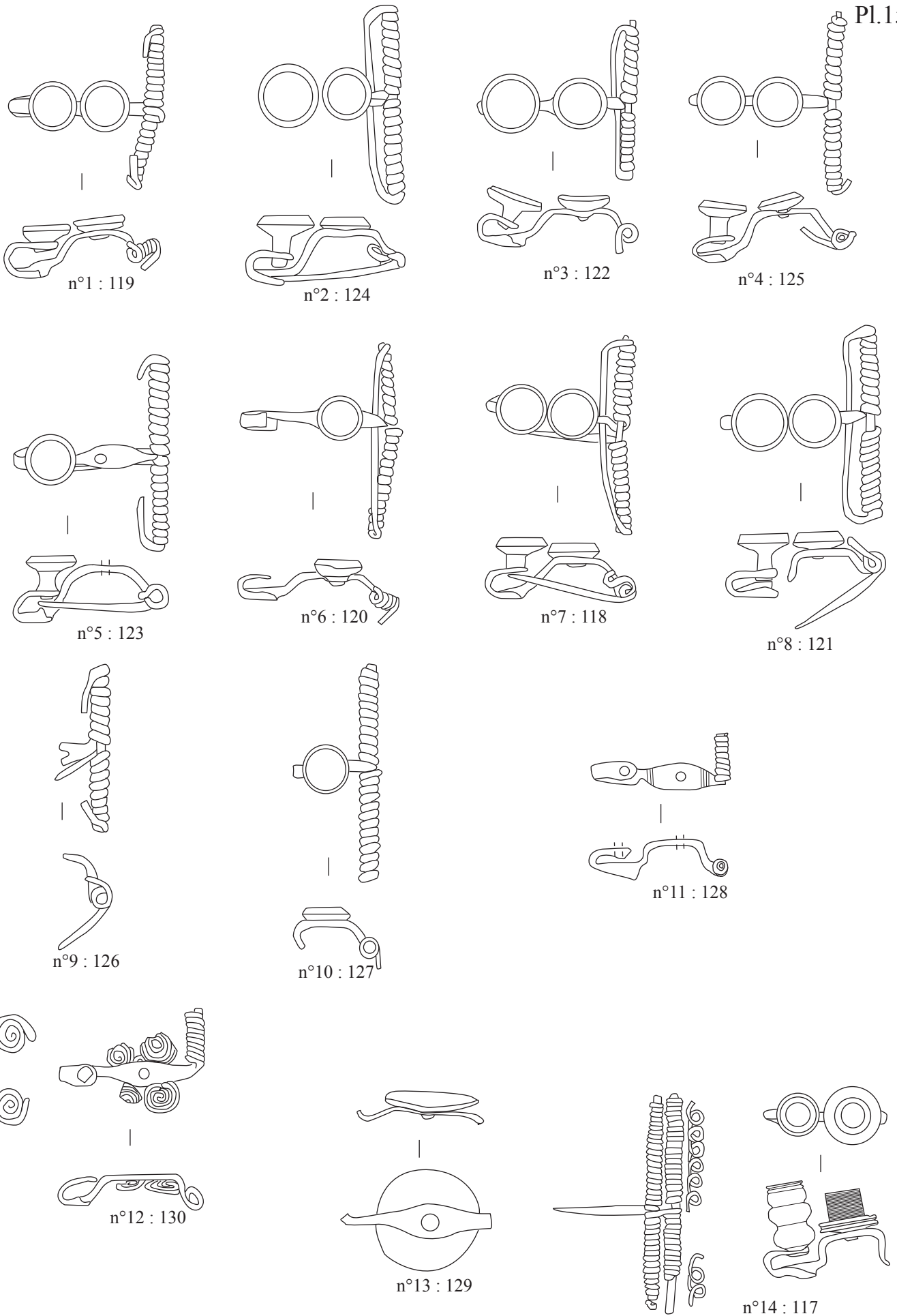

n°1 à 14 : bronze

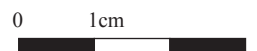

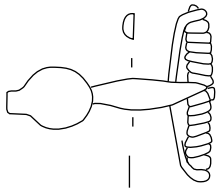

n°1 : 74

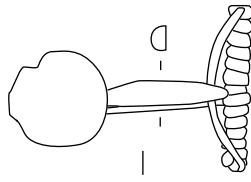

n°6 : 84

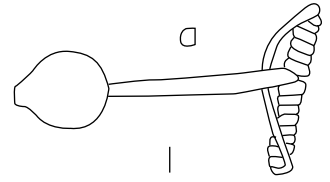
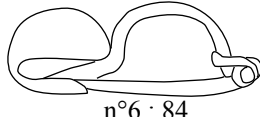

n°12 : 77

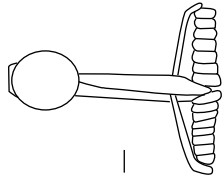
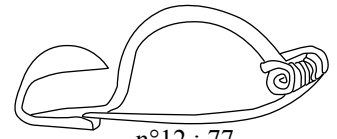

n°2 : 72

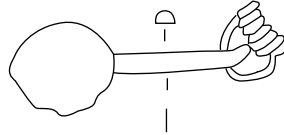
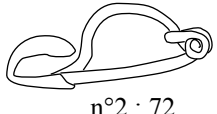

n°7 : 101

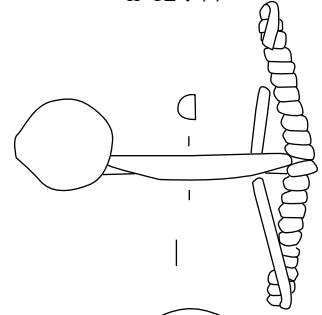
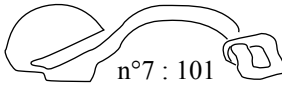

n°13 : 79

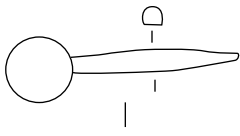
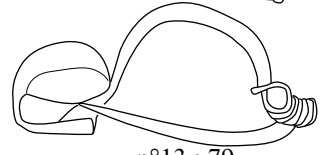

n°3 : 98

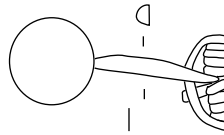
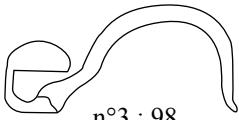

n°8 : 82

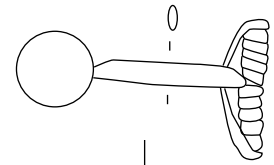
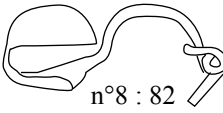

n°14 : 73

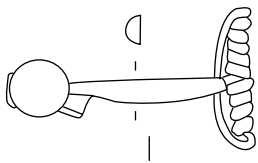
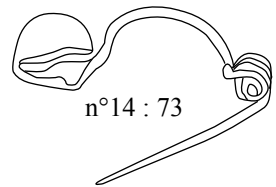

n°4 : 83

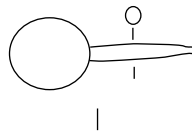
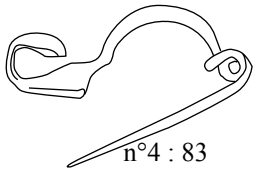

n°9 : 99

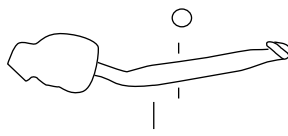
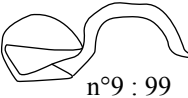

n°10 : 92

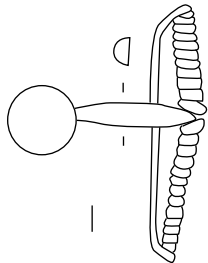
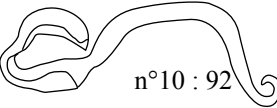

n°5 : 86

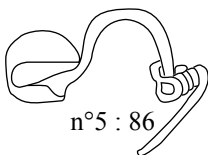

n°11 : 78

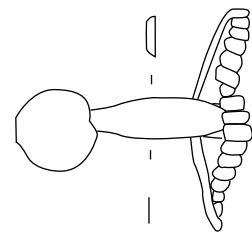
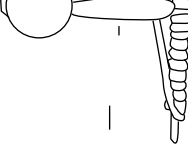

n°15 : 80

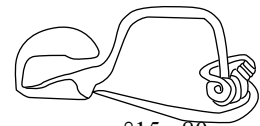

n°16 : 71

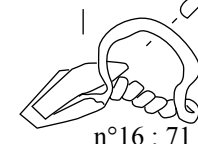

n°1 à 16 : bronze

0 1cm

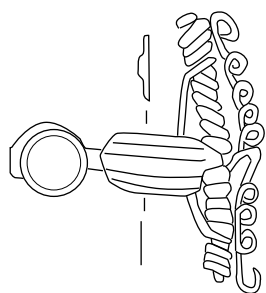

n°1 : 69

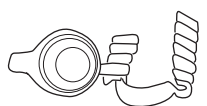
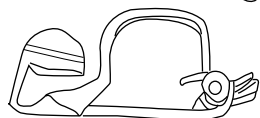

n°2 : 113

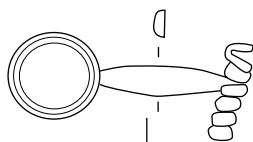

n°4 : 85

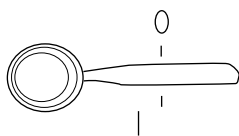

n°5 : 89

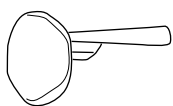

n°6 : 100

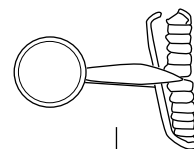
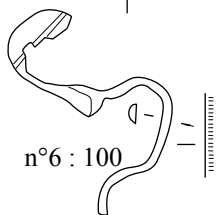

n°9 :

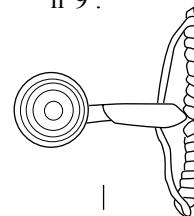

n°10 : 88

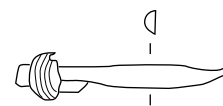
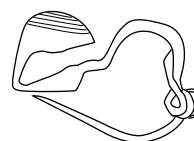

n°11 : 95

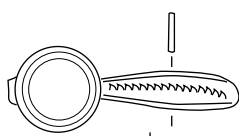

n°7 : 93

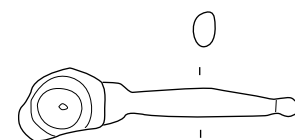
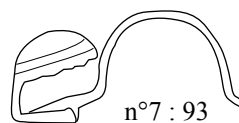

n°12 : 91

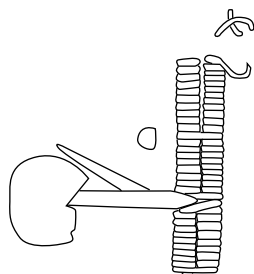
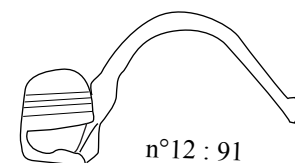

n°3 : 70

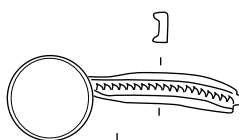

n°8 : 94

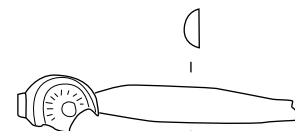
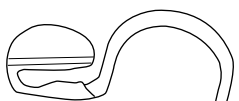

n°13 : 96



n°1 à 13 : bronze

0 1cm

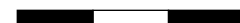

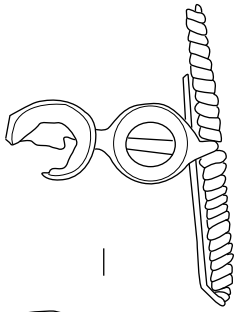

n°1 : 16

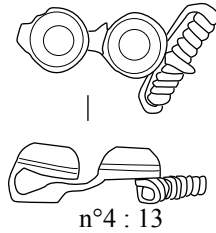

n°4 : 13

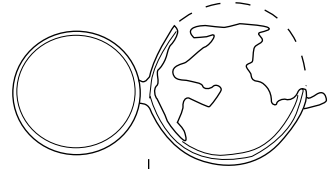
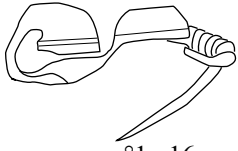

n°6 : 10

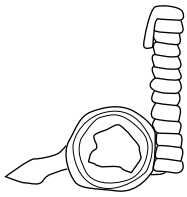

n°2 : 25

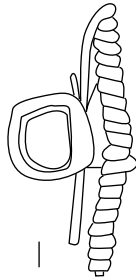

n°5 : 24

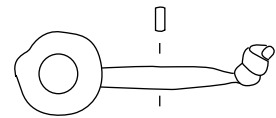
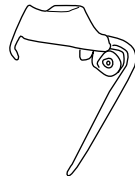
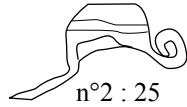
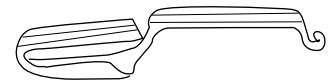

n°9 : 90

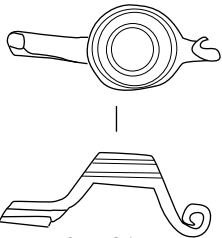

n°7 : 21

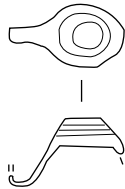

n°8 : 33

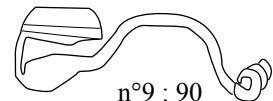

n°10 : 115

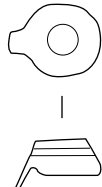

n°11 : 198

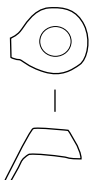

n°12 : 197

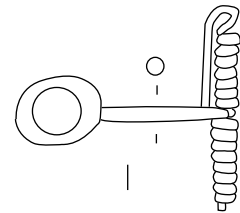

n°13 : 81

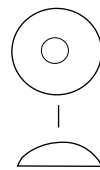

n°14 : 208

n°1 à 14 : bronze

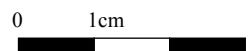

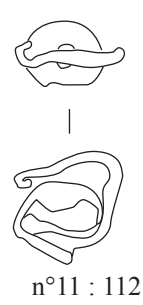
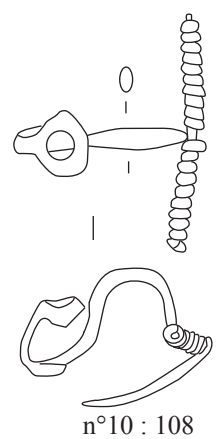
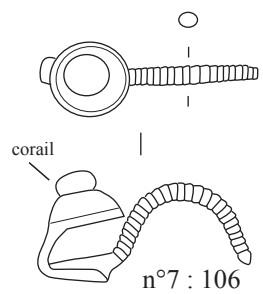
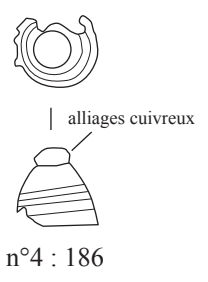
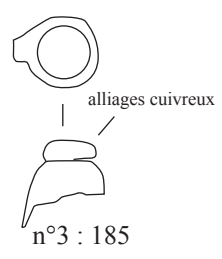
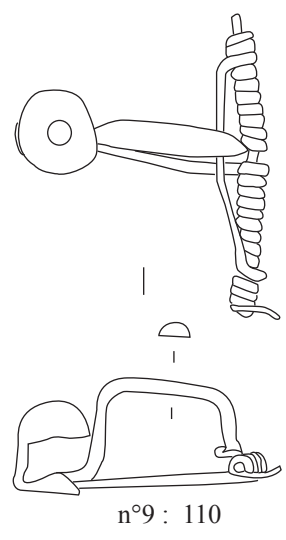
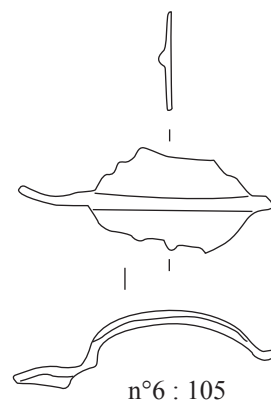
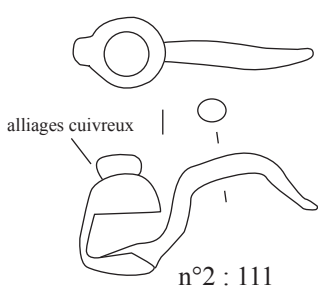
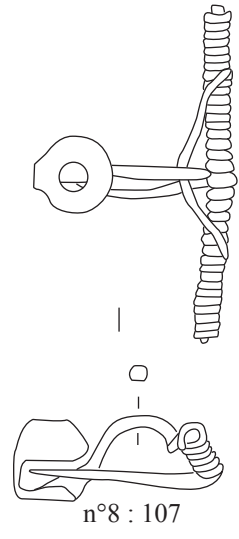
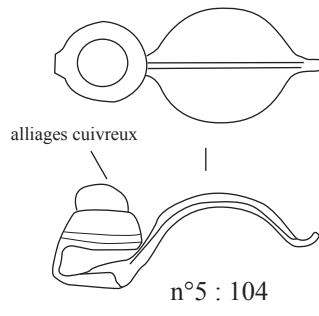
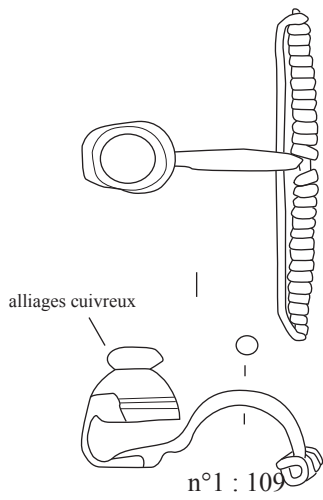

n°1 à 11 : bronze

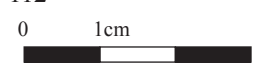

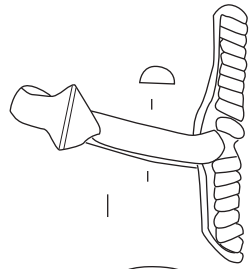

n°1 : 103

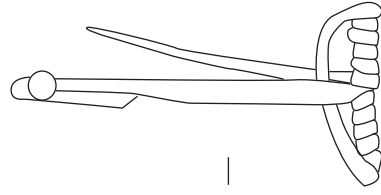

n°4 : 53

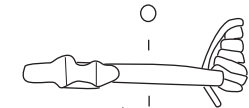
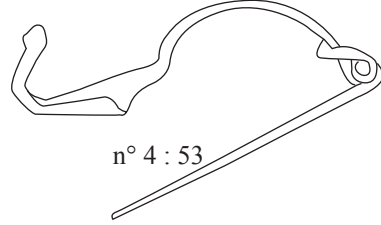

n°2 : 114

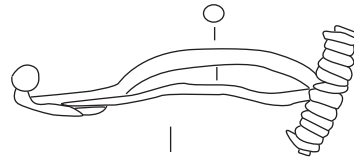
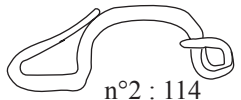

n°5 : 52

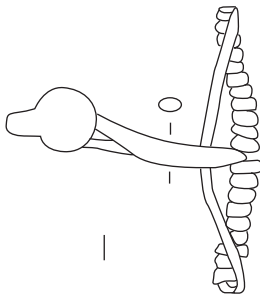

n°3 : 102

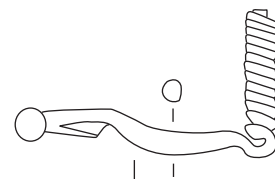

n°6 : 54

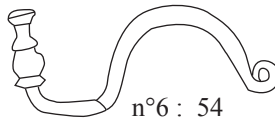

n°1 à 6 : bronze

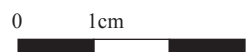



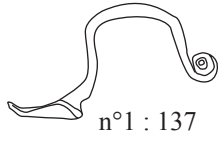
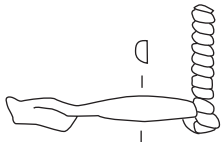

n°1 : 137

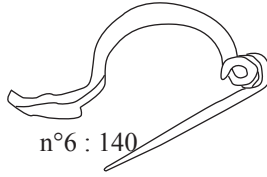
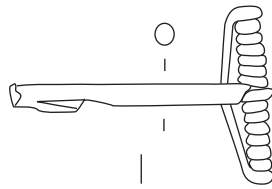

n°6 : 140

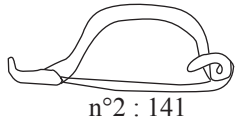
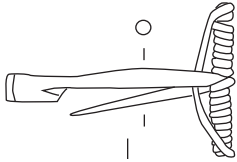

n°2 : 141

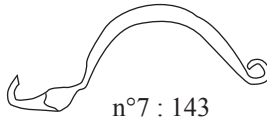
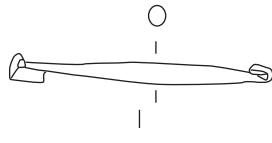

n°7 : 143



n°12 : 131

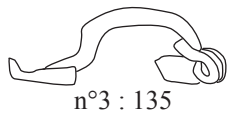
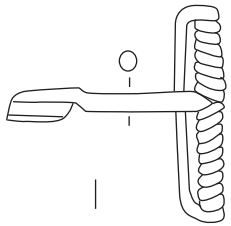

n°3 : 135

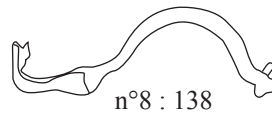
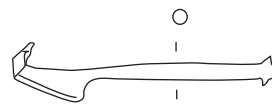

n°8 : 138



n°13 : 146

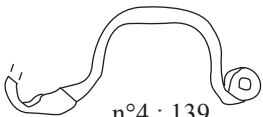
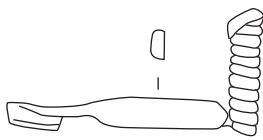

n°4 : 139

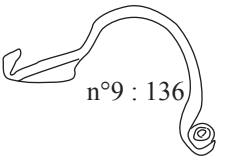

n°9 : 136

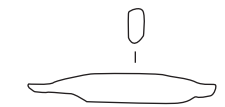

n°14 : 144

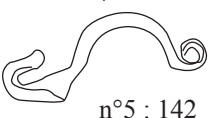
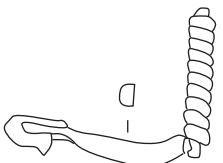

n°5 : 142

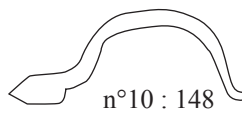

n°10 : 148

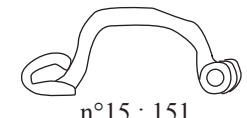
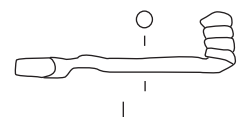

n°15 : 151

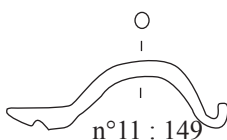

n°11 : 149

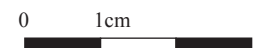

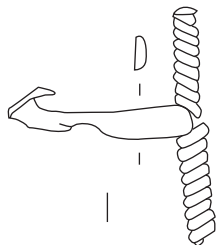

n°1 : 97

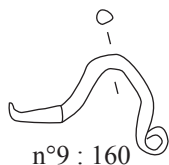

n°9 : 160

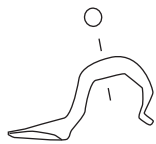

n°10 : 165

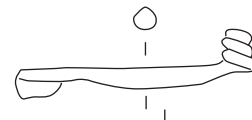

n°11 : 169

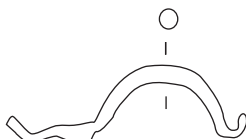
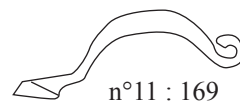

n°2 : 159



n°3 : 176

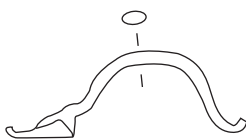

n°4 : 170

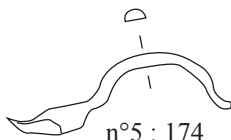

n°5 : 174

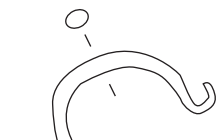

n°6 : 167

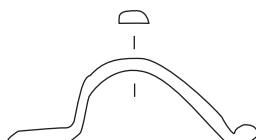

n°7 : 163

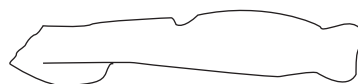

n°12 : 152

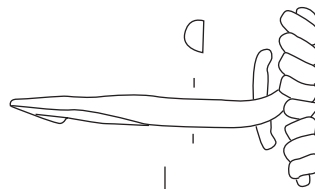
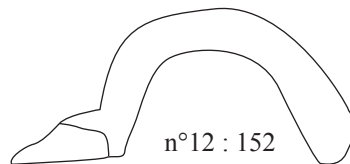

n°13 : 132

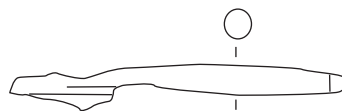
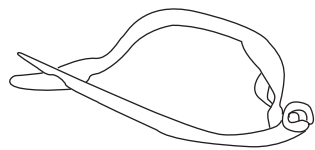

n°14 : 147



n°12 à 14 : fer sinon bronze

0 1cm



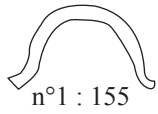
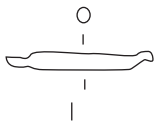

n°1 : 155

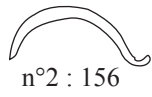
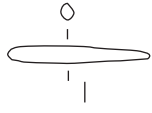

n°2 : 156

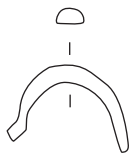

n°3 : 171

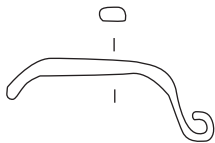

n°4 : 162

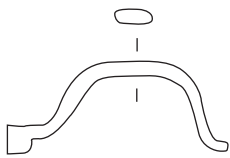

n°5 : 161

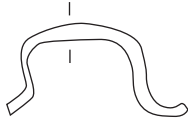

n°6 : 179

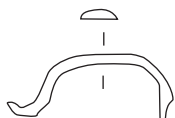

n°7 : 164

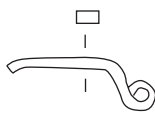

n°8 : 178

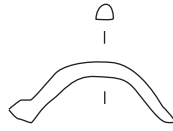

n°9 : 166

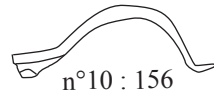
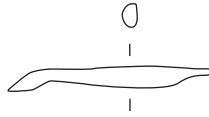

n°10 : 156

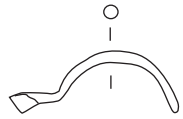

n°11 : 172

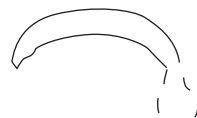
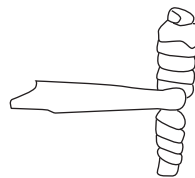

n°12 : 182

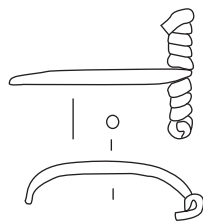

n°13 : 157

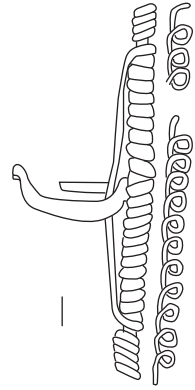

n°14 : 134

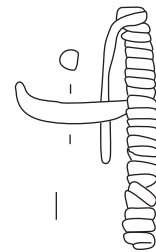

n°15 : 133

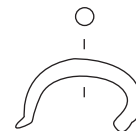

n°16 : 153

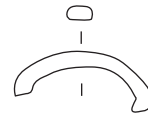

n°17 : 175



n°18 : 180

n°1 à 18 : bronze sauf n°12 : fer

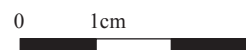



n°1 : 194

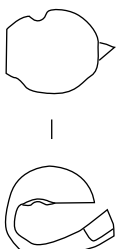

n°2 : 188

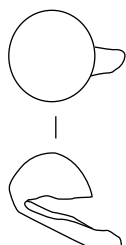

n°3 : 202



n°4 : 195

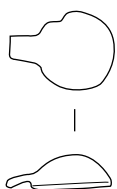

n°5 : 190

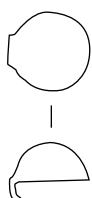

n°6 : 193



n°7 : 199

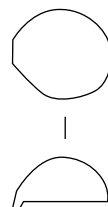

n°8 : 196



n°10 : 211

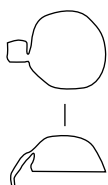

n°11 : 189

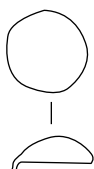

n°12 : 200

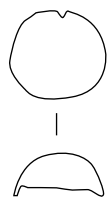

n°13 : 203



n°14 : 201



n°15 : 210



n°16 : 207

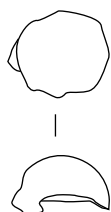

n°17 : 191

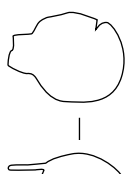

n°18 : 209



n°19 : 205

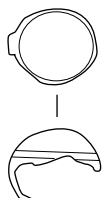

n°20 : 206

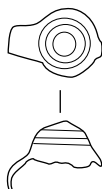

n°21 : 184

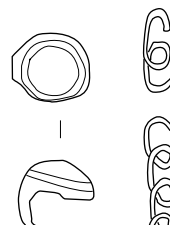

n°22 : 192

n°1 à 22 : bronze

0 1cm

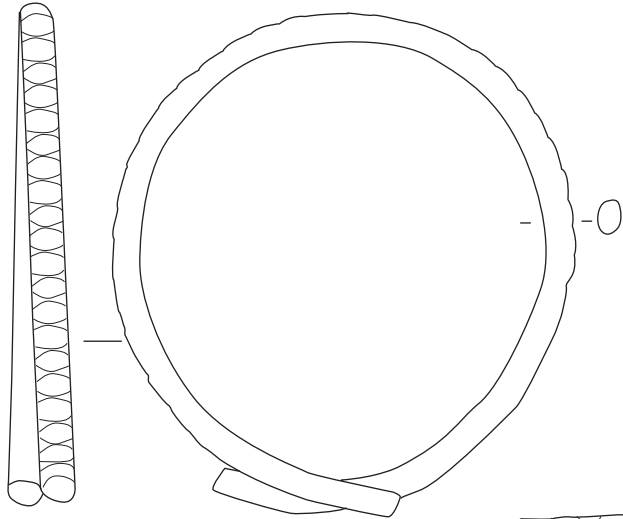

n°1 : 464

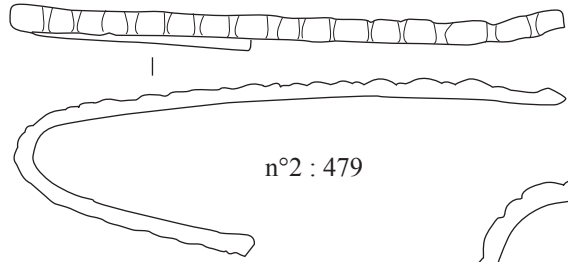

n°2 : 479

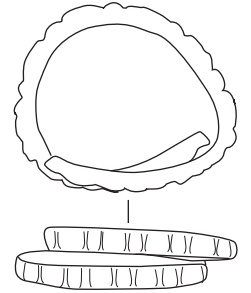

n°3 : 467



n°4 : 478

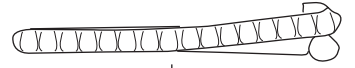

n°5 : 477

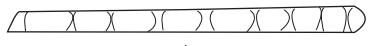

n°7 : 466

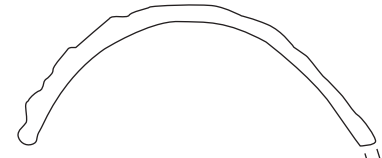

n°8 : 471

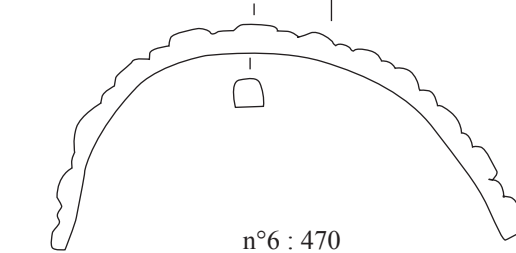

n°9 : 472



n°10 : 474

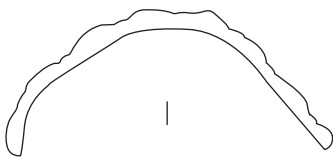

n°11 : 469

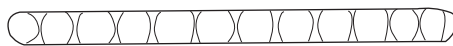

n°12 : 468

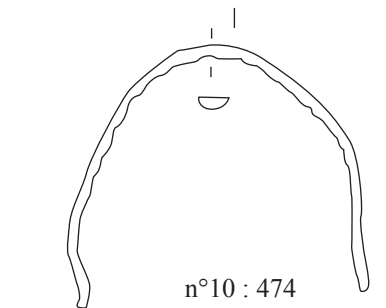

n°13 : 465



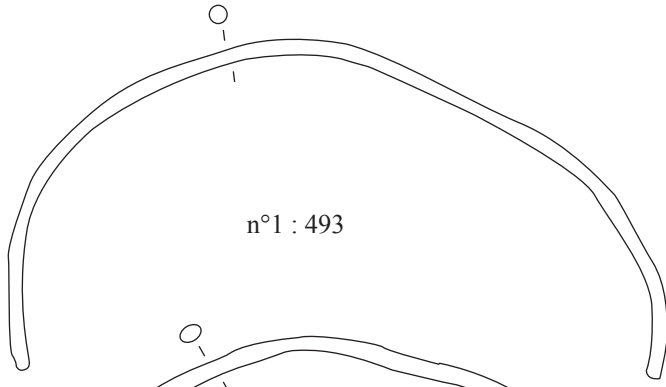

n°1 : 493

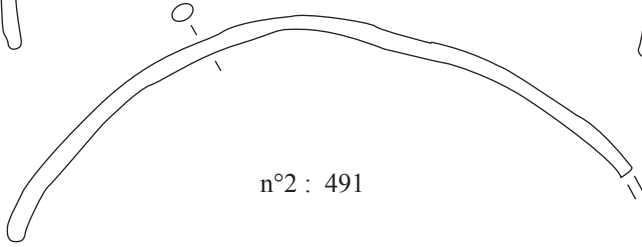

n°2 : 491

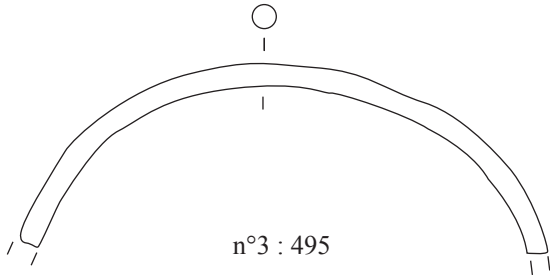

n°3 : 495

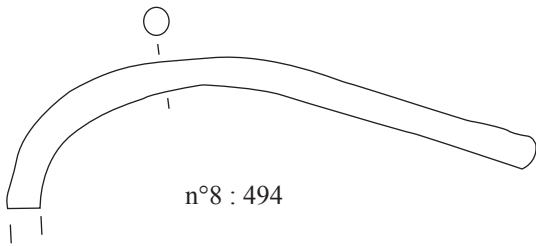

n°8 : 494

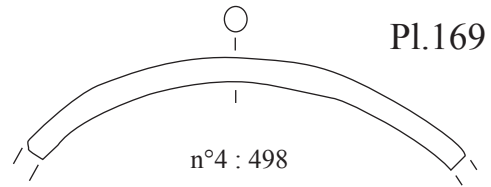

n°4 : 498

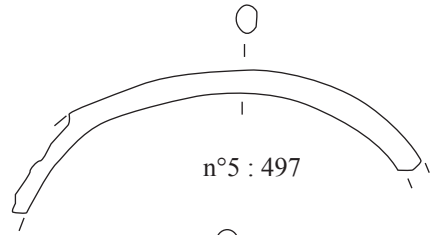

n°5 : 497

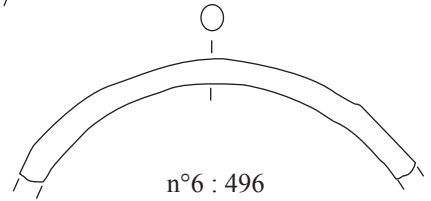

n°6 : 496

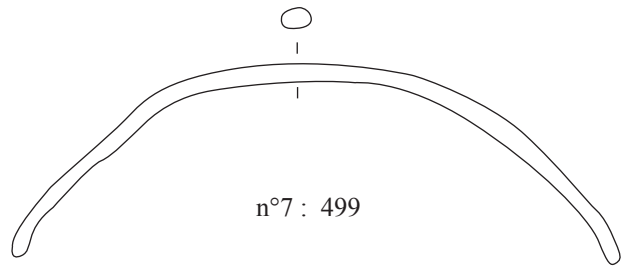

n°7 : 499

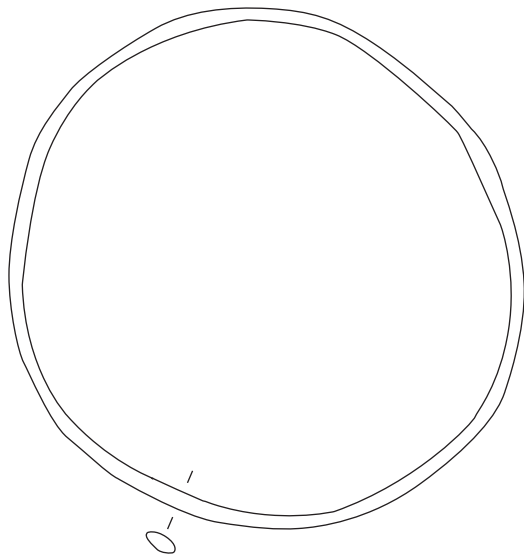

n°9 : 489

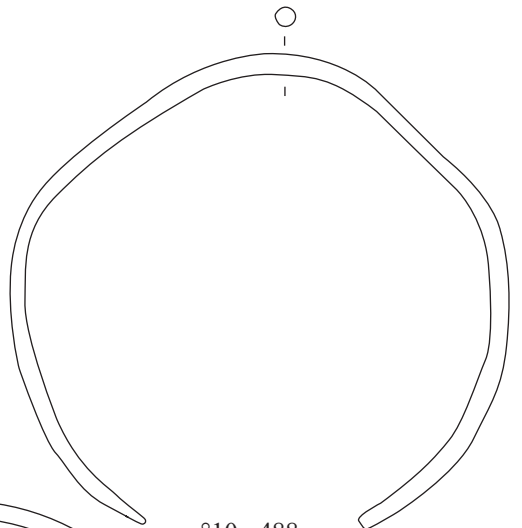

n°10 : 488

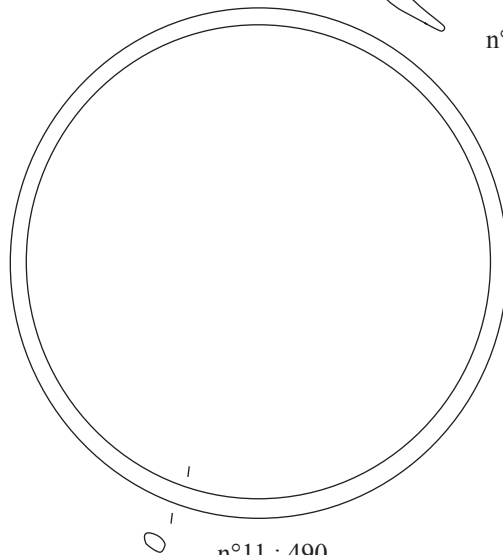

n°11 : 490

n°1 à 11 : bronze

0 1cm

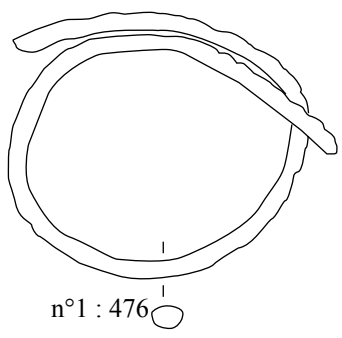

n°1 : 476

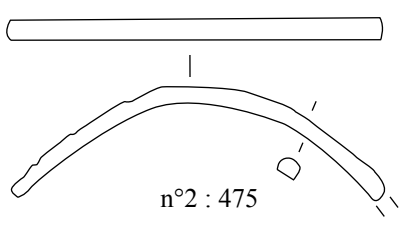

n°2 : 475

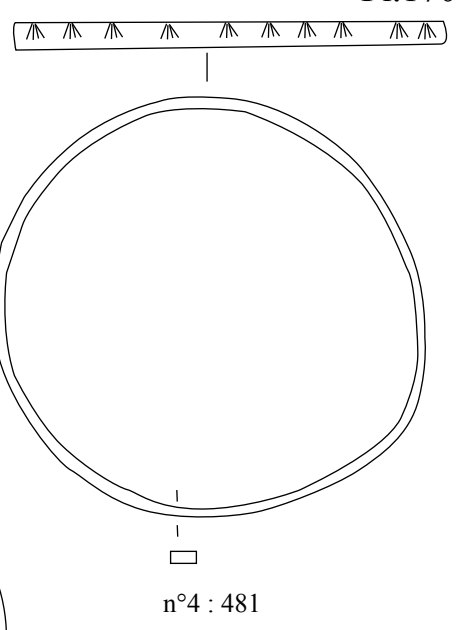

n°4 : 481

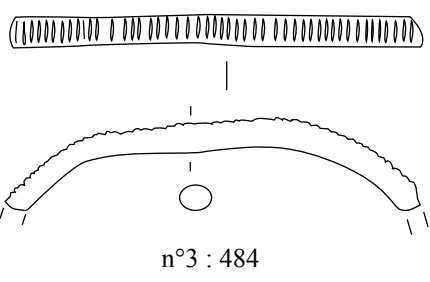

n°3 : 484

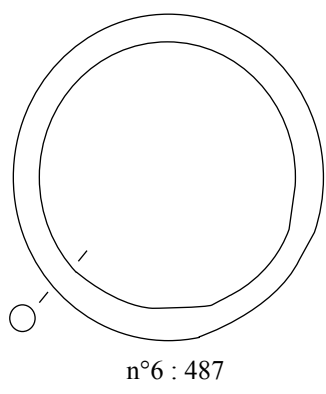

n°6 : 487

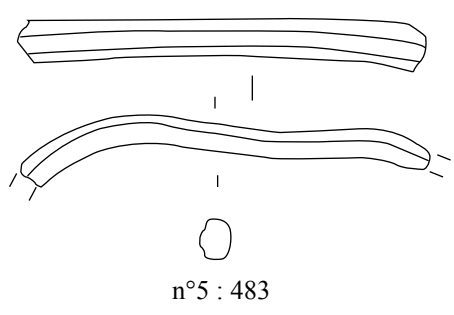

n°5 : 483

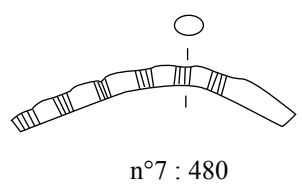

n°7 : 480

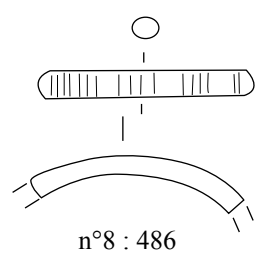

n°8 : 486

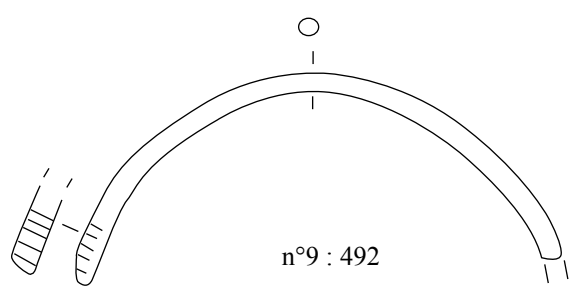

n°9 : 492

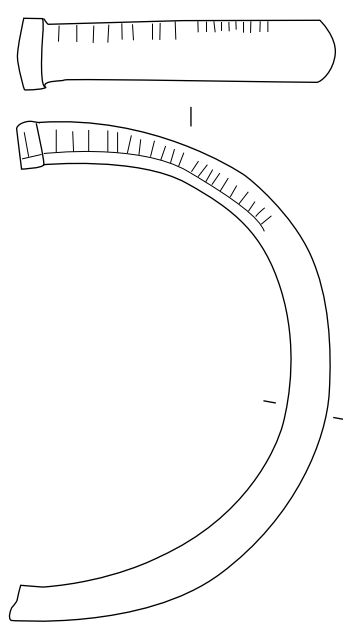

n°10 : 463

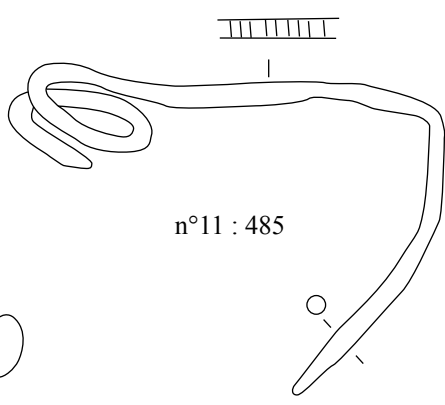

n°11 : 485

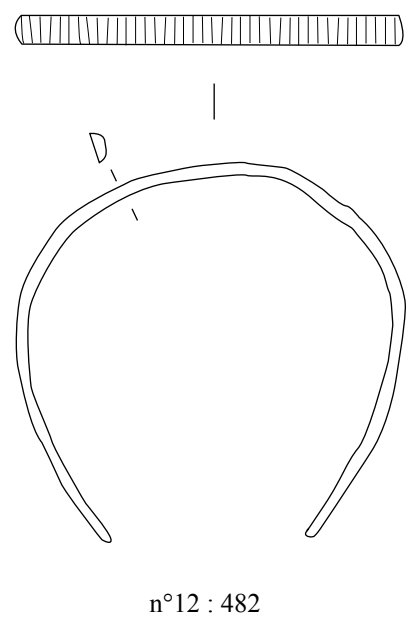

n°12 : 482

n°1 à 12 : bronze

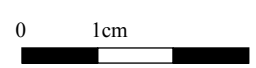

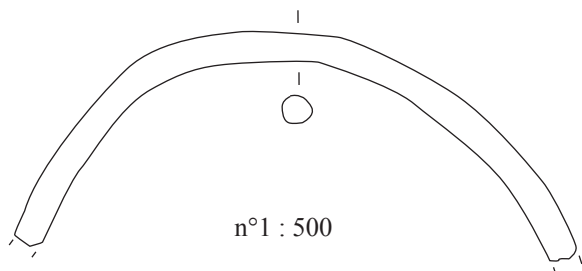

n°1 : 500

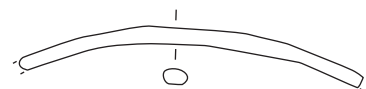

n°8 : 501

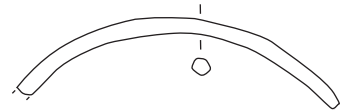

n°9 : 506

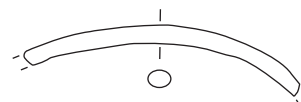

n°10 : 505

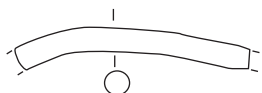

n°2 : 510

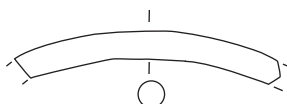

n°3 : 504

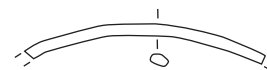

n°11 : 509

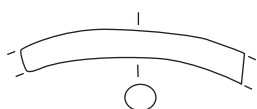

n°4 : 502

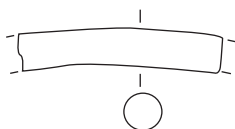

n°7 : 503



n°12 : 508

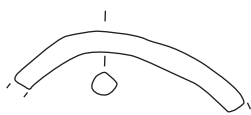

n°5 : 511



n°13 : 516

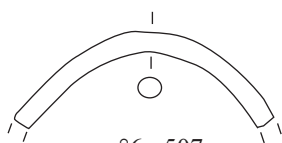

n°6 : 507

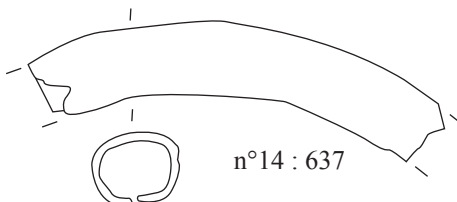

n°14 : 637

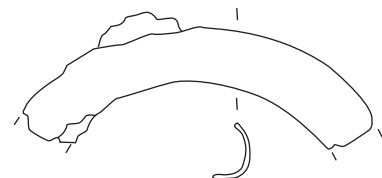

n°15 : 518

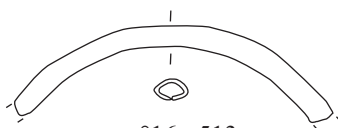

n°16 : 513

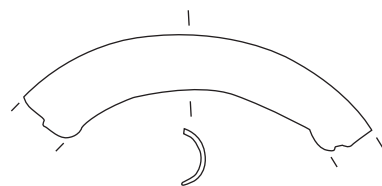

n°17 : 517

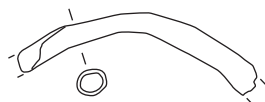

n°19 : 512

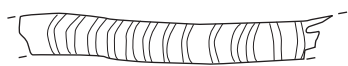

n°18 : 519

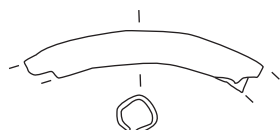

n°21 : 515

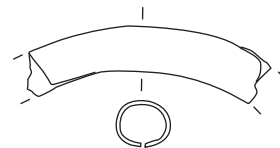

n°20 : 514

n°1 à 21 : bronze





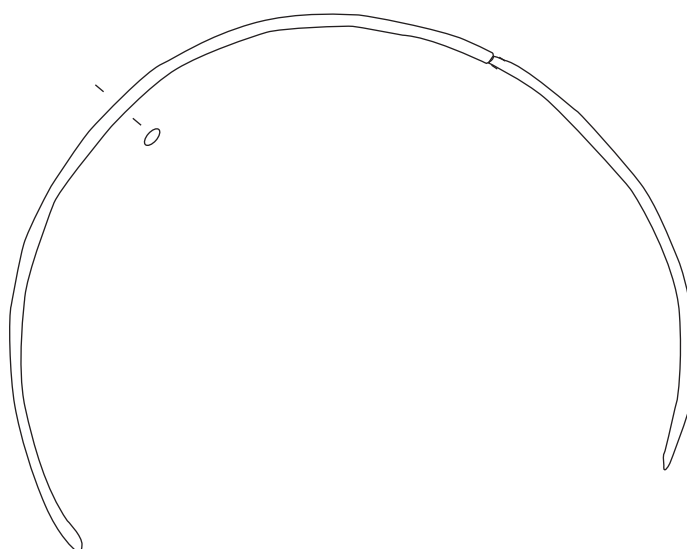
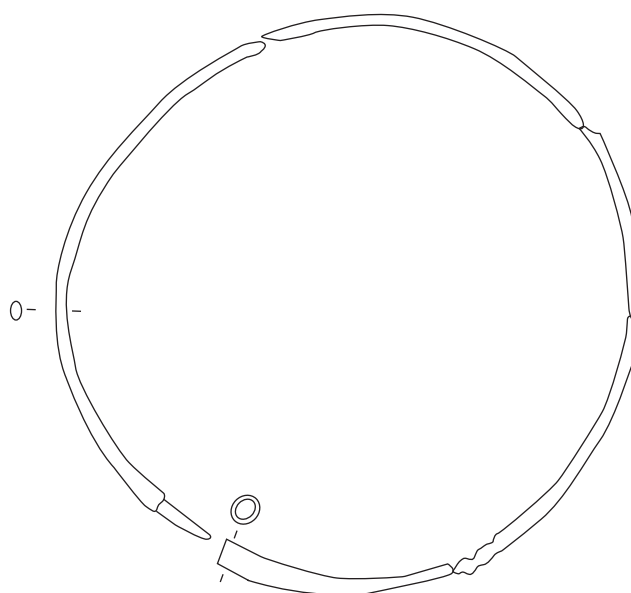
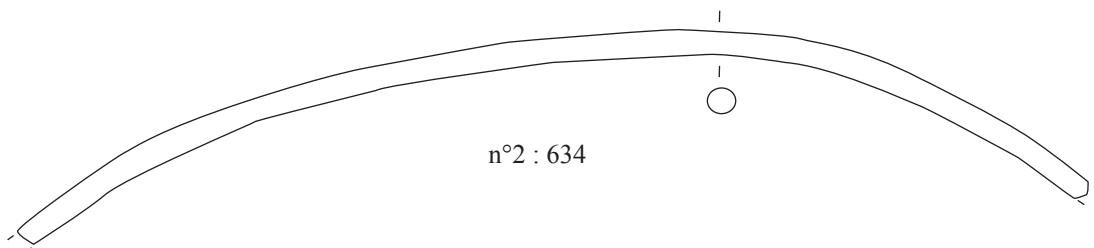
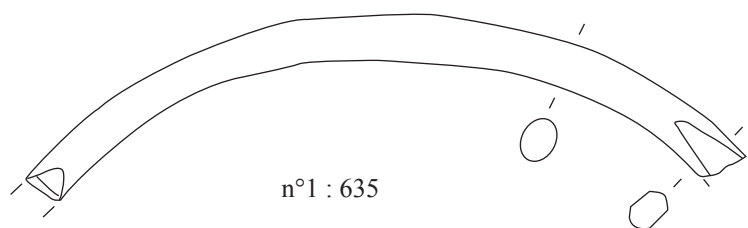

n°4 : 636

n°1 à 4 : bronze

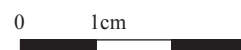

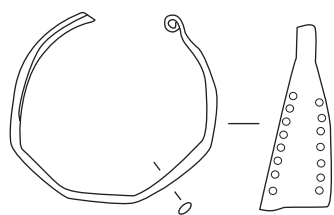

n°1 : 705

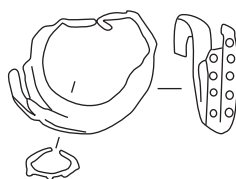

n°2 : 706

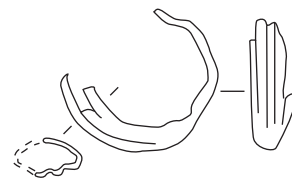

n°3 : 707

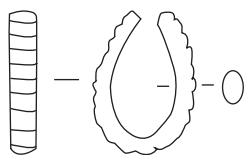

n°4 : 665

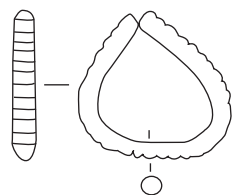

n°5 : 666

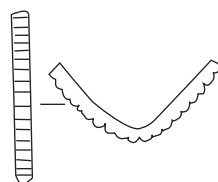

n°6 : 667

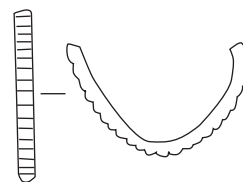

n°7 : 668

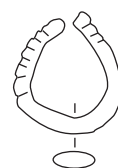

n°8 : 664

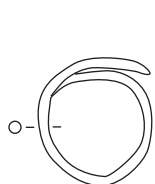

n°9 : 655

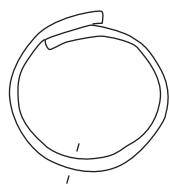

n°10 : 656

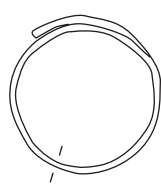

n°11 : 657

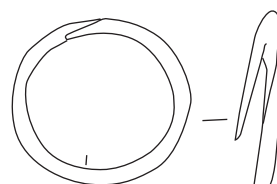

n°12 : 658

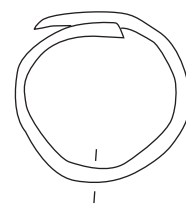

n°13 : 659



n°14 : 669



n°15 : 670



n°16 : 674

n°1 à 16 : bronze



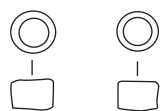

n°1 : 775

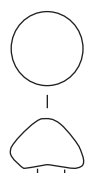

n°2 : 778

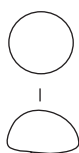

n°3 : 779

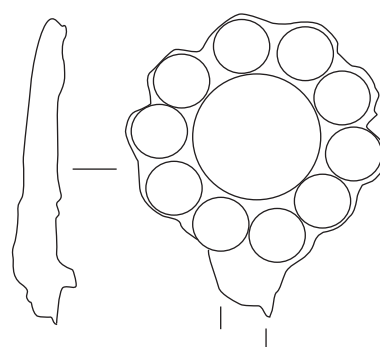

n°7 : 743

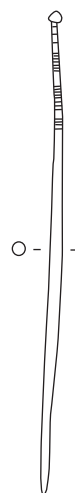

n°4 : 737

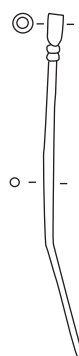

n°5 : 739

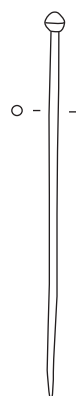

n°6 : 740



n°8 : 766



n°9 : 770

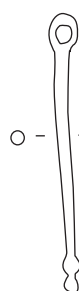

n°10 : 769

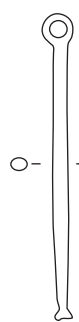

n°11 : 768

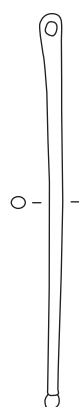

n°12 : 767



n°13 : 771

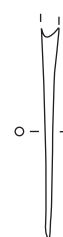

n°14 : 758

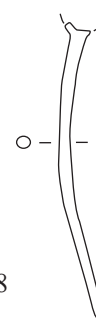

n°15 : 757

n°1 à 15 : bronze sauf n°7 : fer



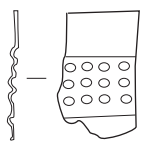

n°1 : 717

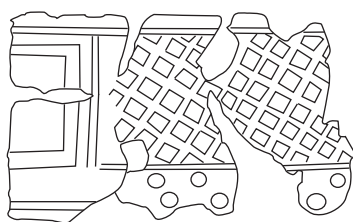

n°2 : 718

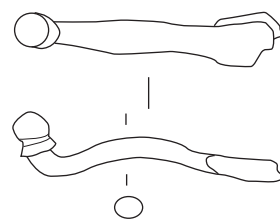

n°3 : 719

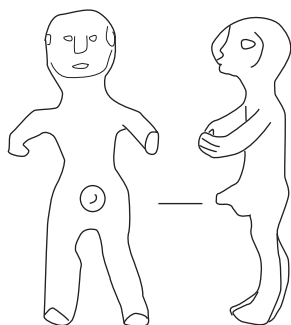

n°4 : 686

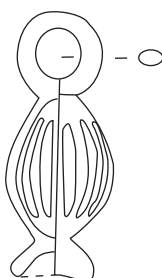

n°5 : 688

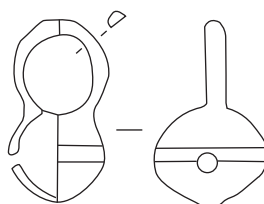

n°6 : 689



n°7 : 690

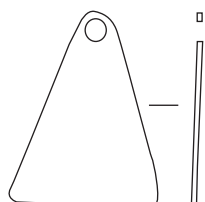

n°8 : 692

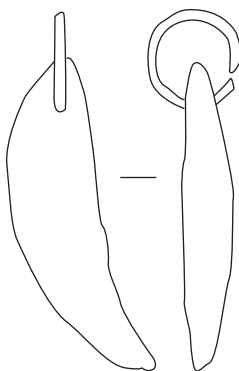

n°9 : 697

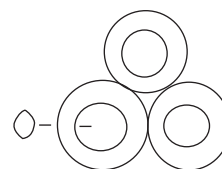

n°10 : 691

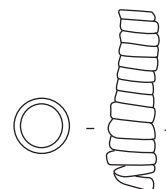

n°14 : 695



n°11 : 696

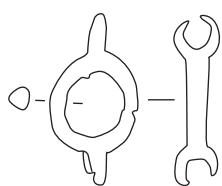

n°12 : 693

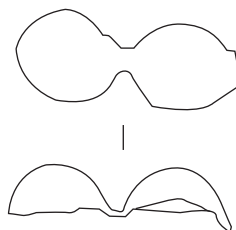

n°13 : 38



n°15 : 694

n°1 à 15 : bronze

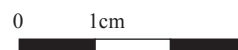

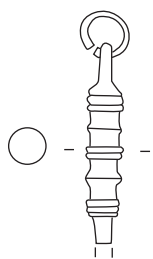

n°1 : 732

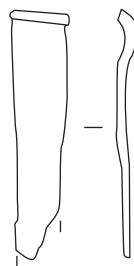

n°2 : 734

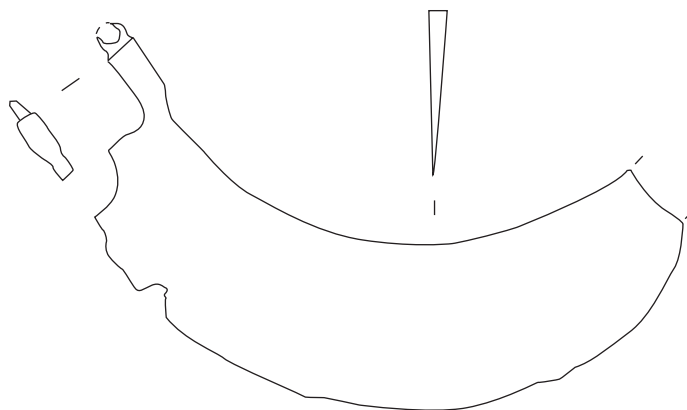

n°3 : 772

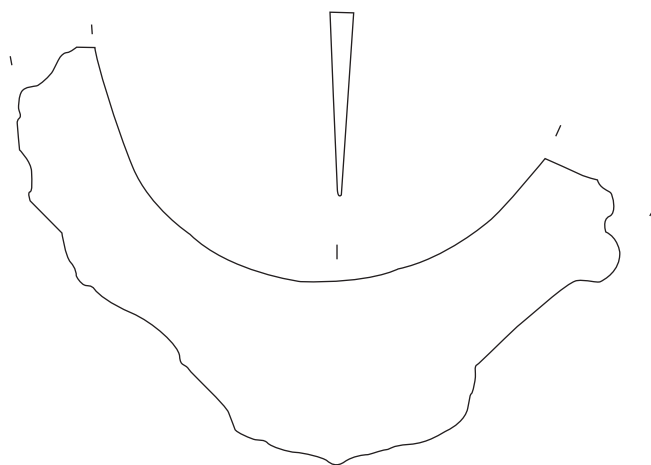

n°4 : 773

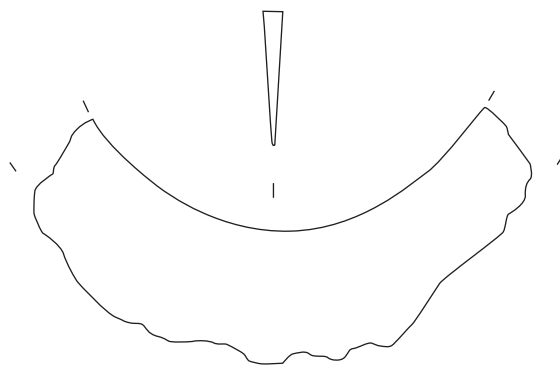

n°5 : 774

n°1-2 : bronze ; n°3 à 5 : fer

0 1cm



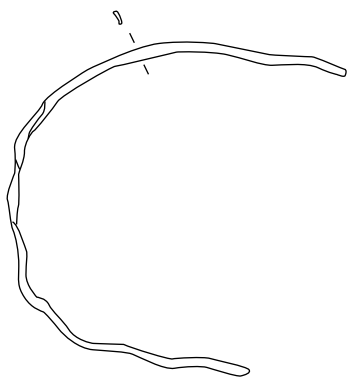

n°1 : 1171

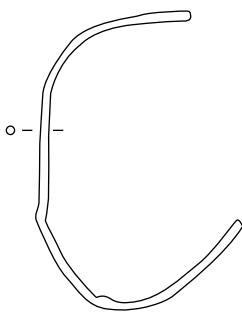

n°2 : 1172

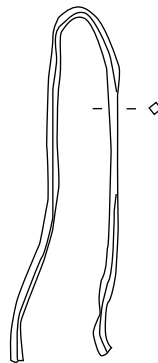

n°3 : 1151

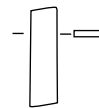

n°4 : 1189



n°5 : 1188

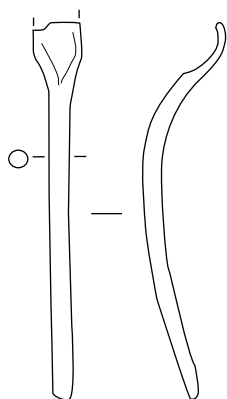

n°6 : 1175

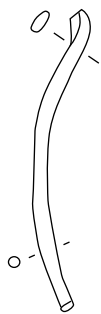

n°7 : 1178

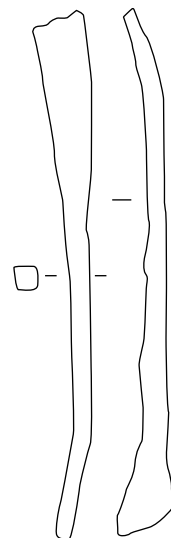

n°8 : 1180

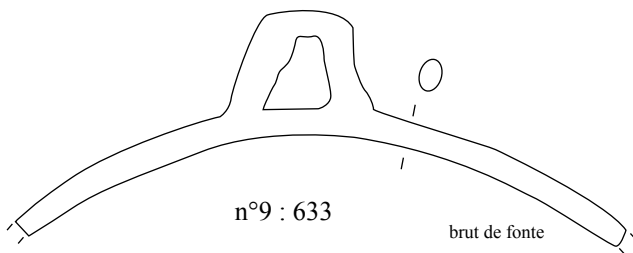

n°9 : 633

brut de fonte

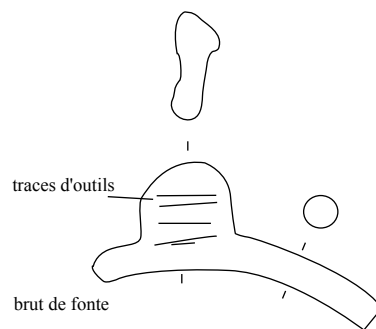

n°10 : 520

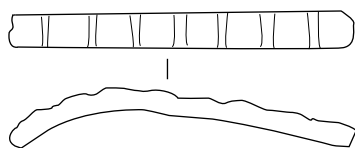

n°11 : 473 brut de fonte

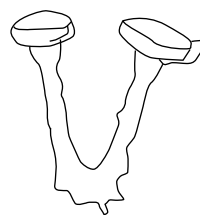

n°12 : 59

n°1 à 12 : bronze

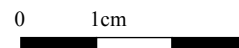

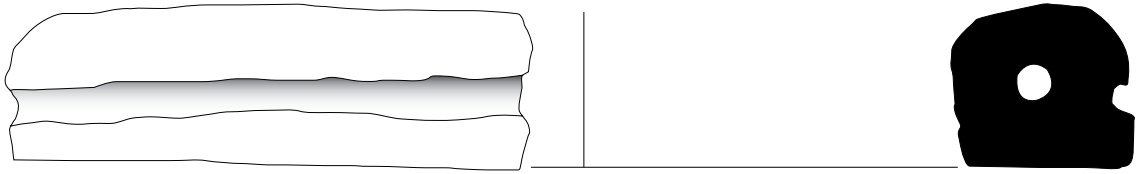

n°1

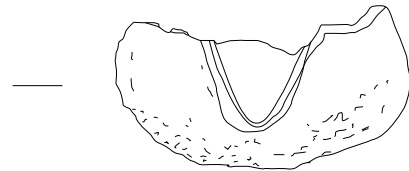
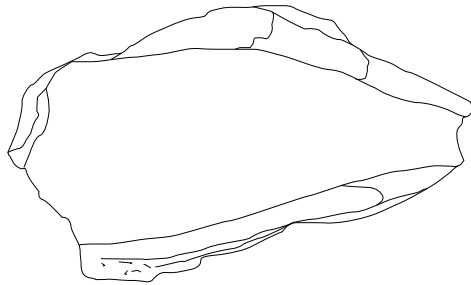

n°2

n°1-2 : terre cuite

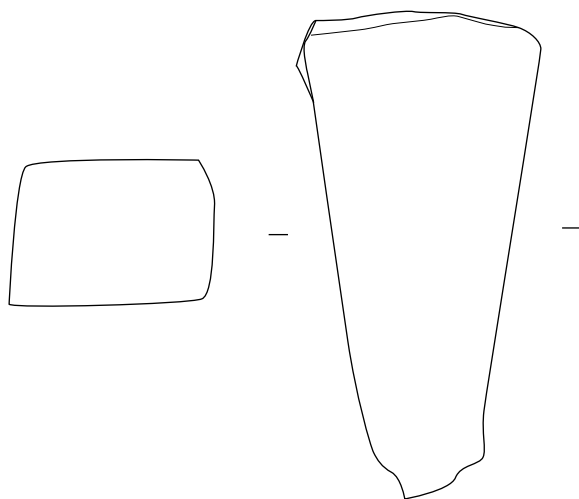

n°1 : 1233

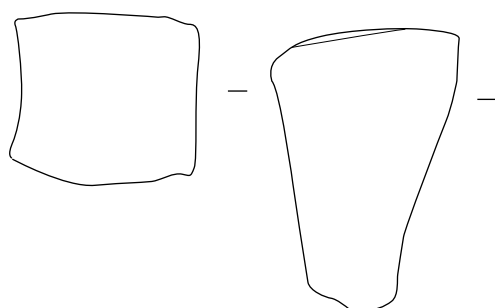

n°2 : 1232

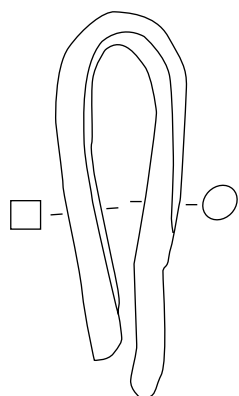

n°3 : 1185

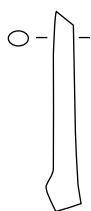

n°4 : 1182

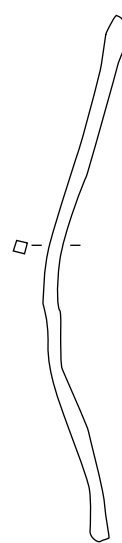

n°5 : 1173

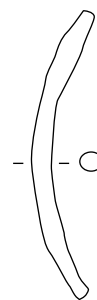

n°6 : 1174

n°1-2 : fer sinon bronze

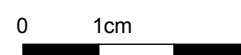



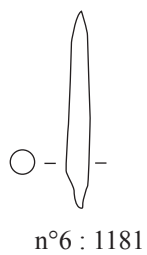
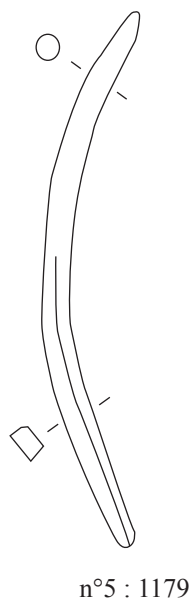
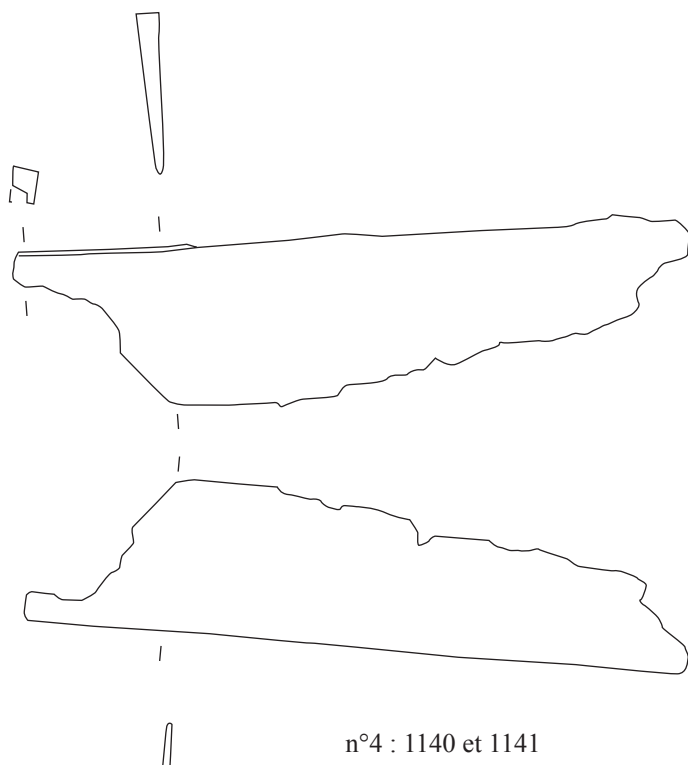
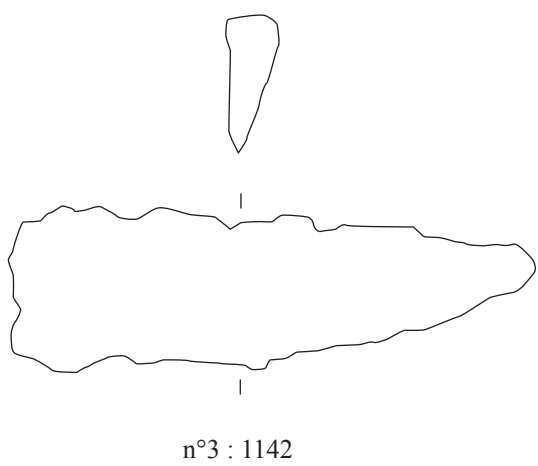
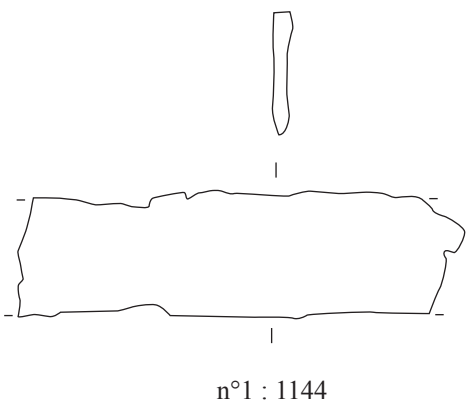
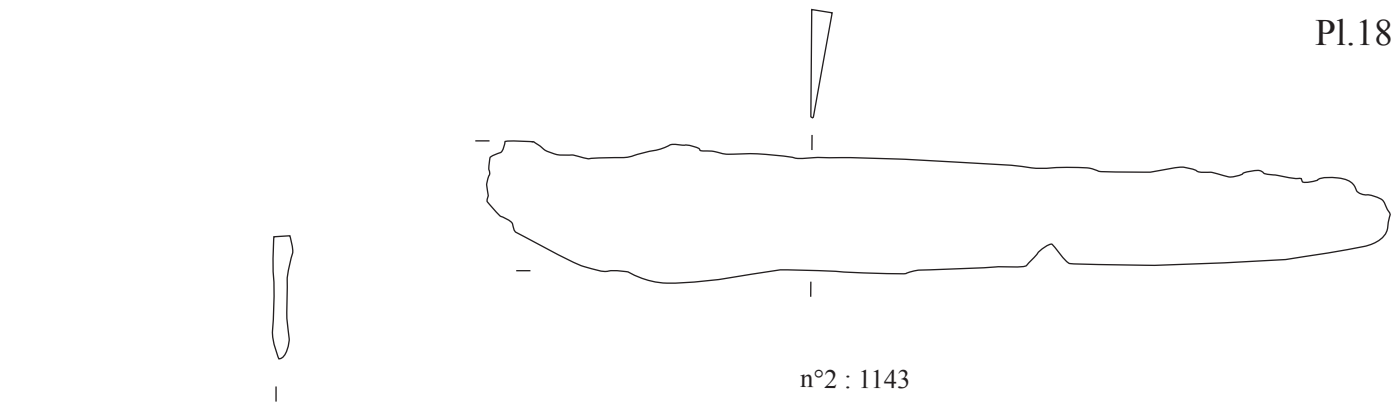

n°1 à 4-6 : fer ; n°5 : bronze

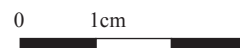

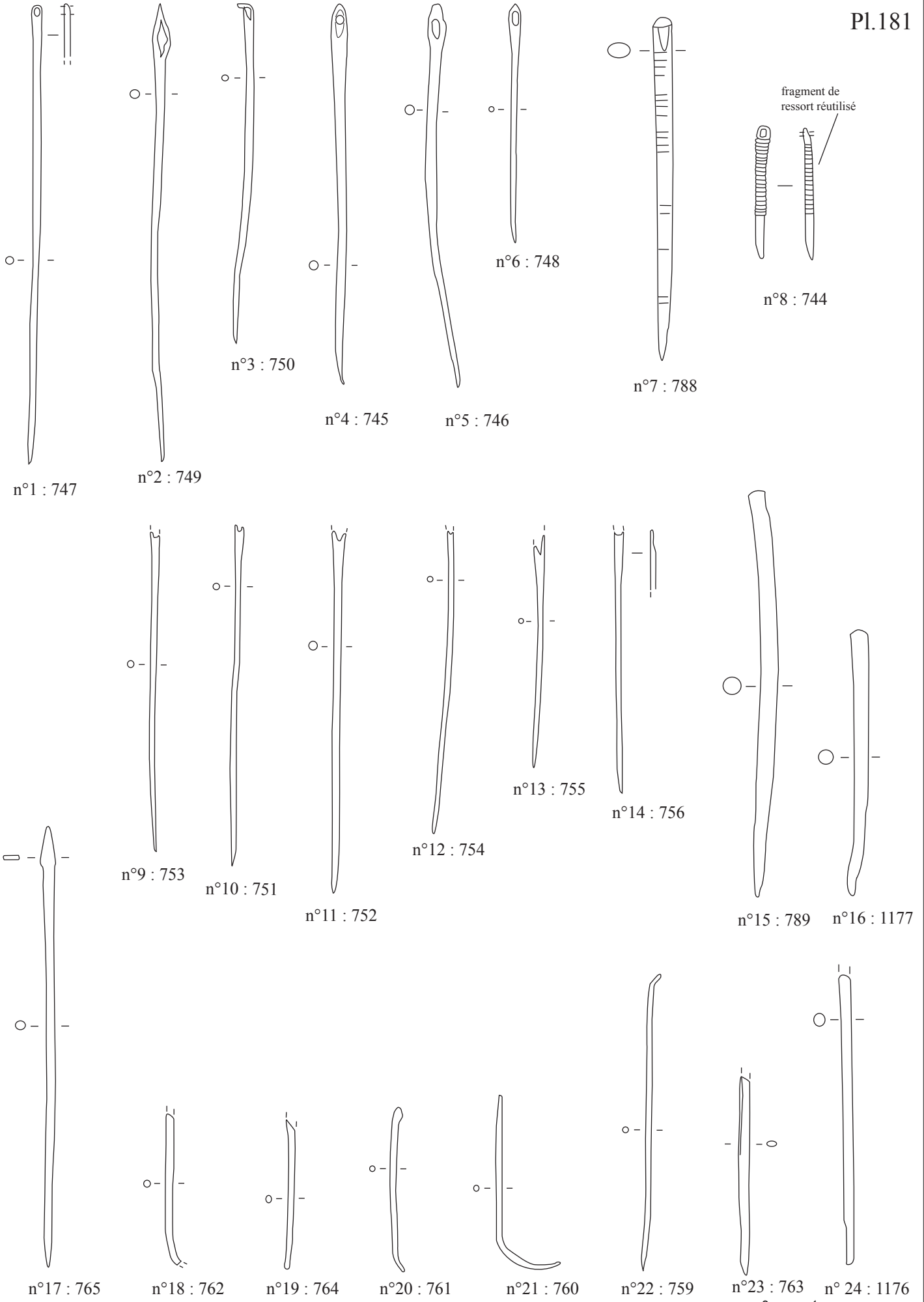

n°1 à 24 : bronze

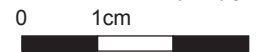

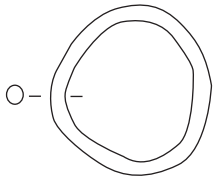

n°1 : 660

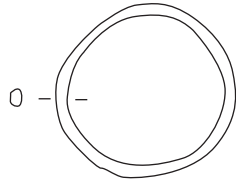

n°2 : 661

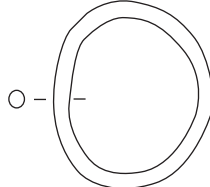

n°3 : 663

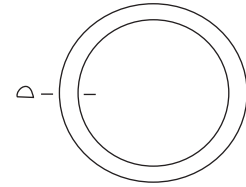

n°4 : 662



n°5 : 673

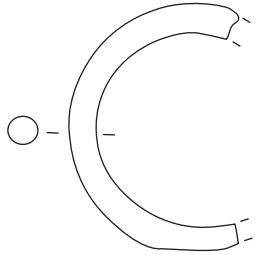

n°6 : 647

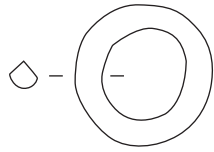

n°7 : 644

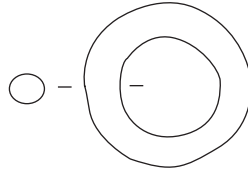

n°8 : 645

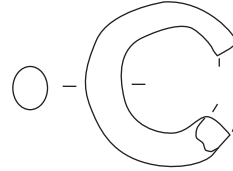

n°9 : 646

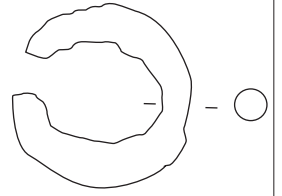

n°10 : 649

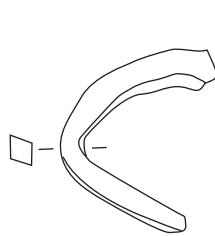

n°11 : 679

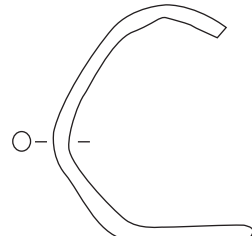

n°12 : 677

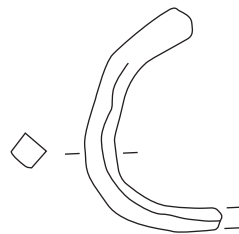

n°13 : 680

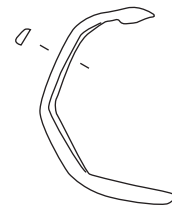

n°14 : 678

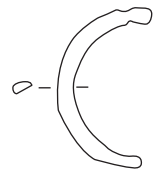

n°15 : 676

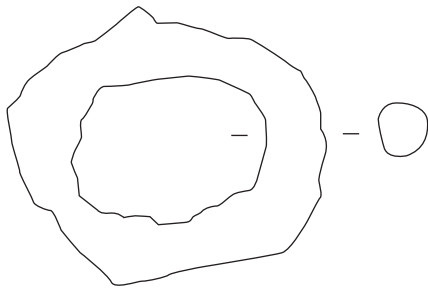

n°16 : 651

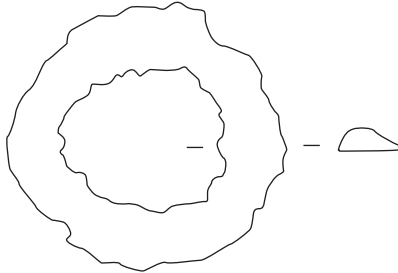

n°17 : 652

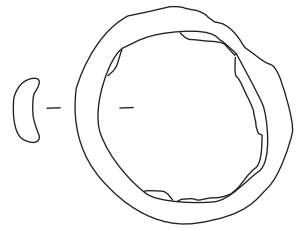

n°18 : 648

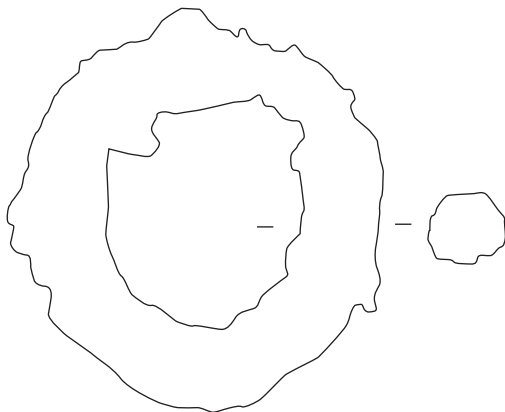

n°19 : 654

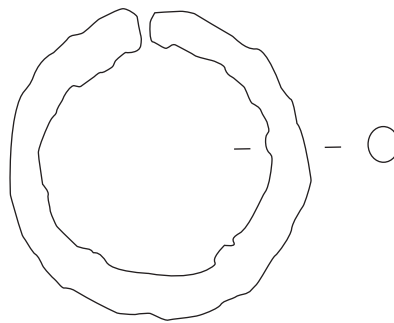

n°20 : 653

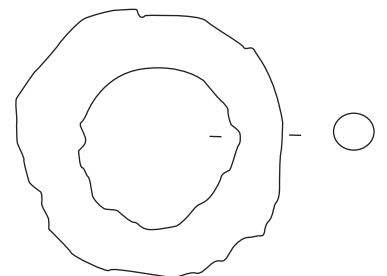

n°21 : 650

n°1 à 15 : bronze ; n°16 à 21 : fer

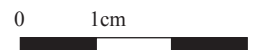

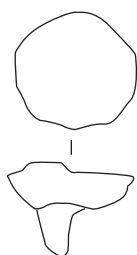

n°1 : 781



n°2 : 782

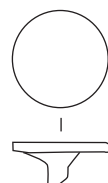

n°3 : 783



n°4 : 784

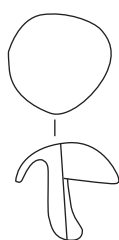

n°6 : 785

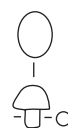

n°5 : 777

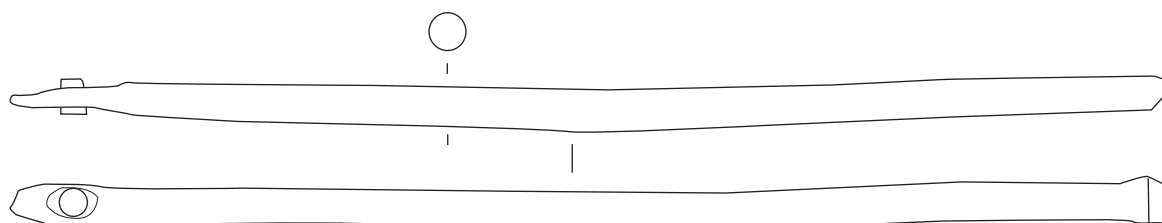

n°7 : 1135

n°1 à 2 : fer sinon bronze



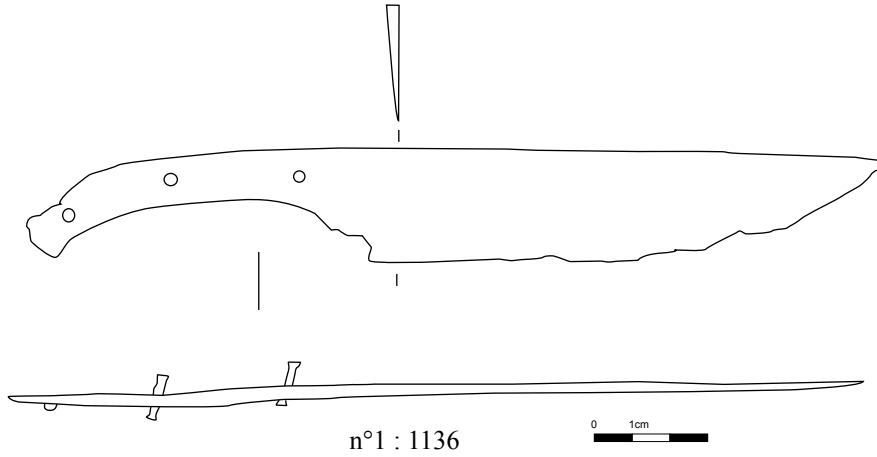

n°1 : 1136

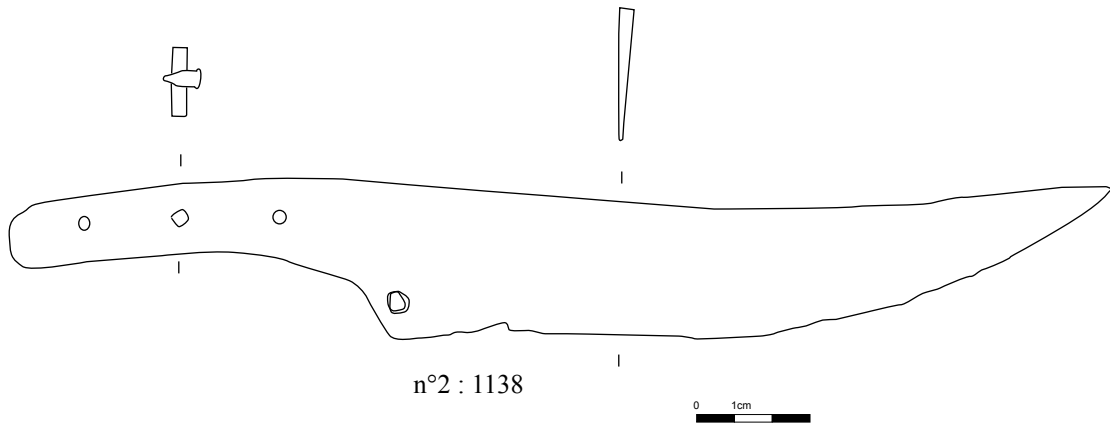
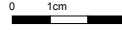

n°2 : 1138

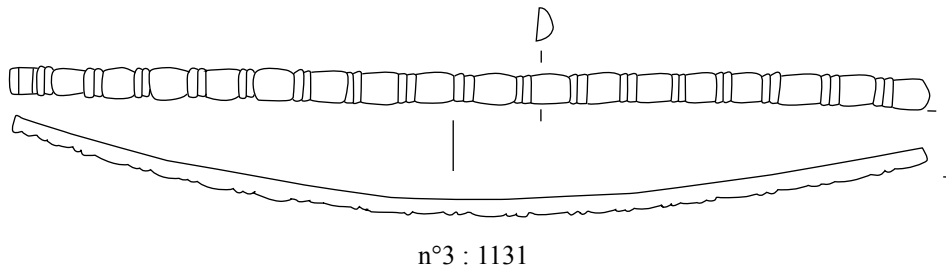
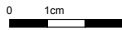

n°3 : 1131

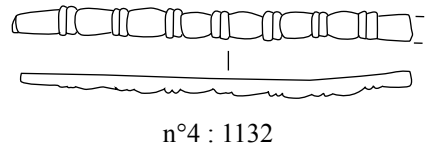

n°4 : 1132

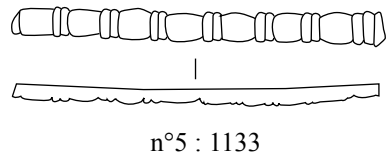

n°5 : 1133



n°6 : 687

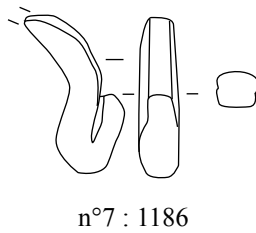

n°7 : 1186

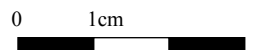

n°1-2 : fer sinon bronze

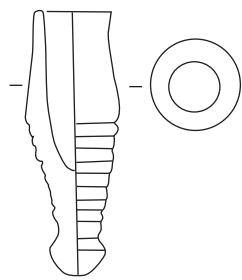

n°1 : 1127

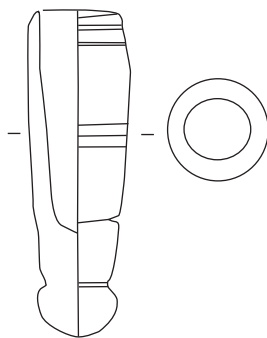

n°2 : 1128

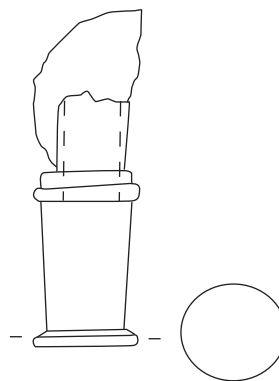

n°3 : 1129

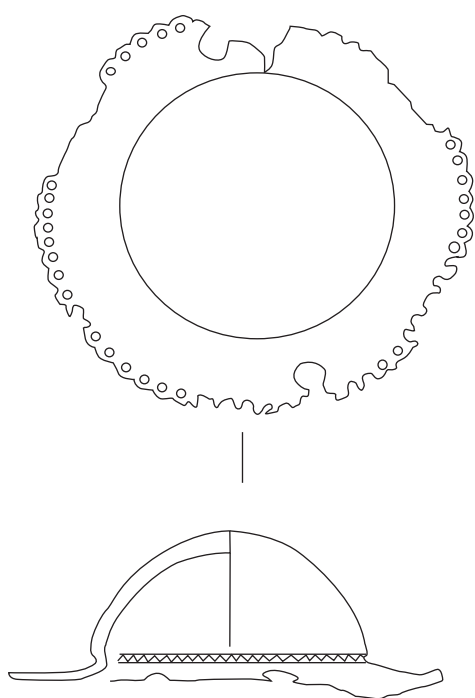

n°4 : 1130

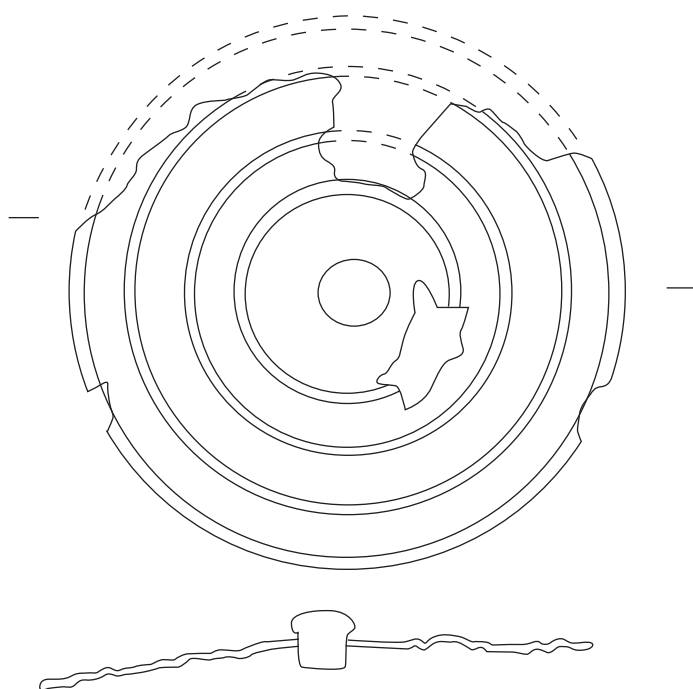

n°5 : 1116

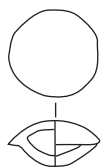

n°5 : 776

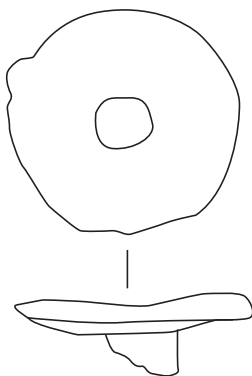

n°6 : 1247



n°7 : 780

n°6 : fer sinon bronze

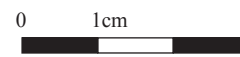



# Mancey Charmes



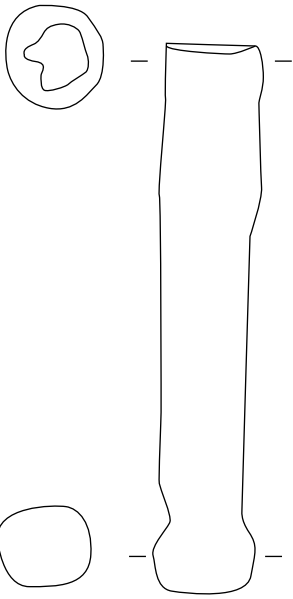

n°1 : III-08.119

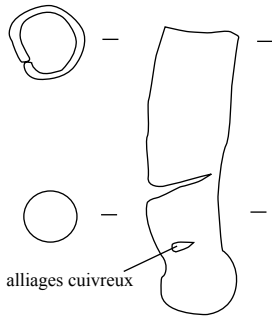

alliages cuivreux

n°2 : L7/L8-L7.108

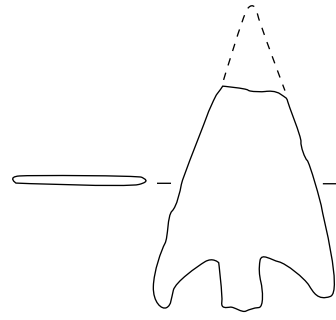

n°4 : III-M8.5

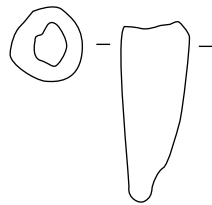
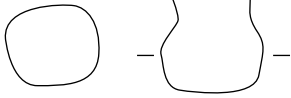

n°3 : III-M9.46

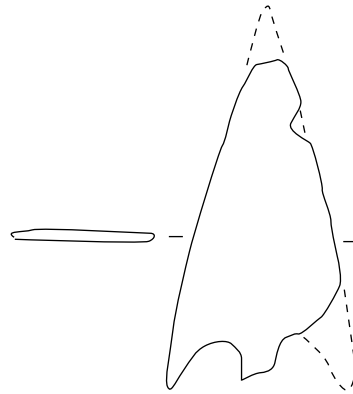

n°5 : III-M8.5



n°6 : III-L7.80

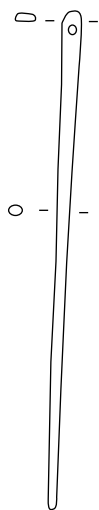

n°7 : III-N8.215

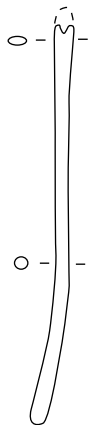

n°8 : III-M9.52

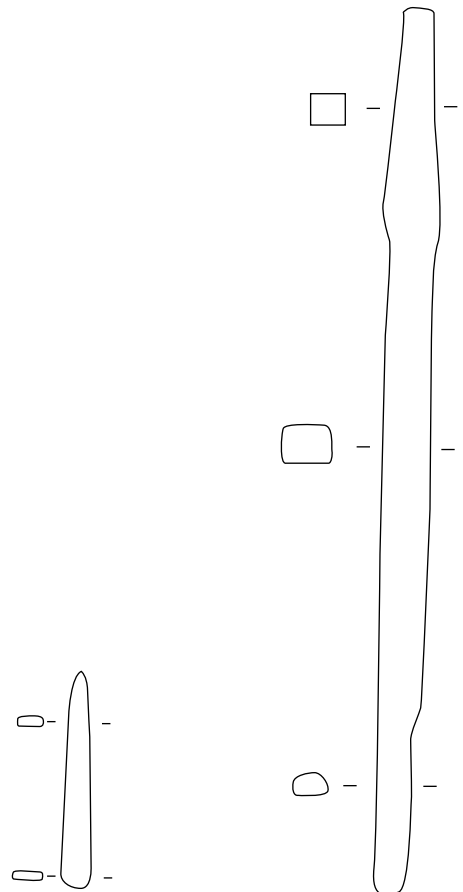

n°9 : L7-98

n°10 : L7/L8-L8.142

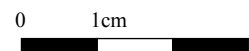

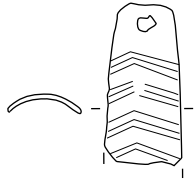

n°1 : III-08.40



n°3 : 08.190

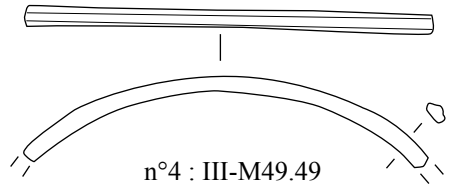

n°4 : III-M49.49

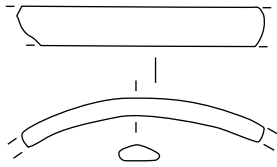

n°2 : III-N8.85

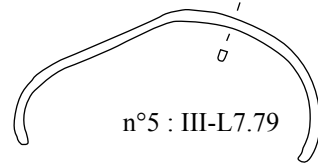

n°5 : III-L7.79

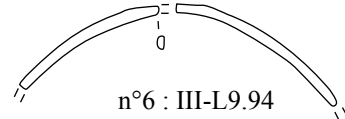

n°6 : III-L9.94

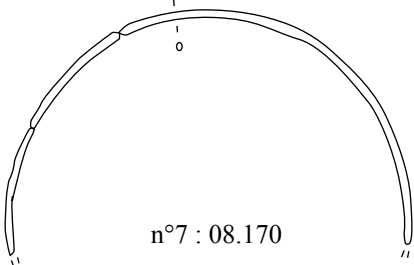
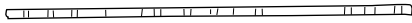

n°7 : 08.170

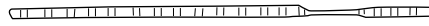

n°8 : III-L9.89

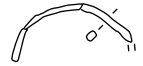
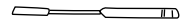

n°9 : III-N8.226



n°10 : O-P7.5

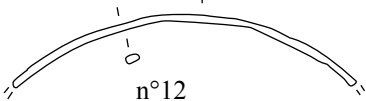
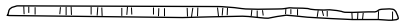

n°12

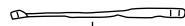

n°14 : III-M6.6

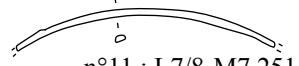
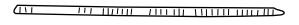

n°11 : L7/8-M7.251

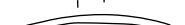
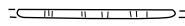

n°16 : L7/8-L8.133

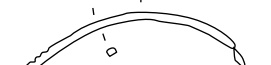

n°17 : L7/8-L8.136

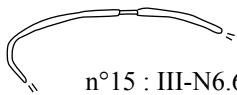
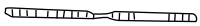

n°15 : III-N6.61

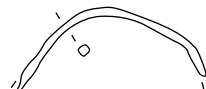
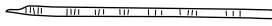

n°19 : L5.10

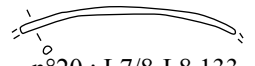

n°20 : L7/8-L8.133

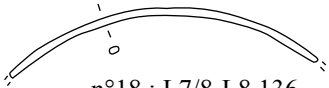
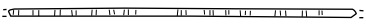

n°18 : L7/8-L8.136

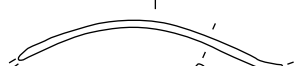

n°22 : L7/8-L8.134

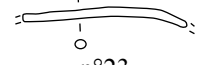
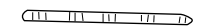

n°23



n°21 : fosse Q-Q6.97

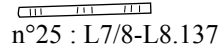

n°25 : L7/8-L8.137

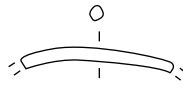

n°26 : III-M9.53

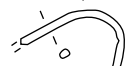
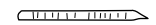

n°27 : fosse Q-Q7.199

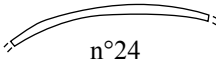
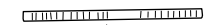

n°24

0 1cm

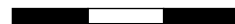

n°1 à 27 : bronze

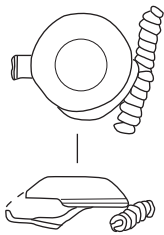

n°1 : III-Q4.10

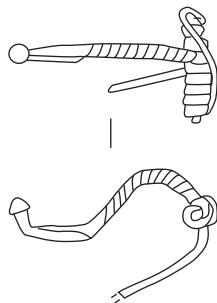

n°2 : N8-245

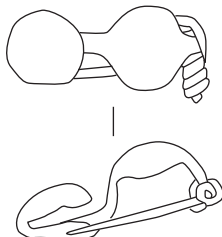

n°3 : fosse Q-Q7.178

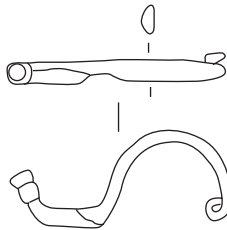

n°4 : M7.252

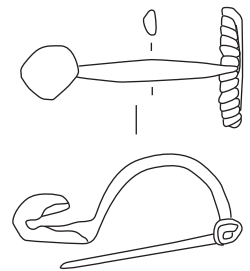

n°5 : L7/8-L8.125



n°7 : III-M9.54

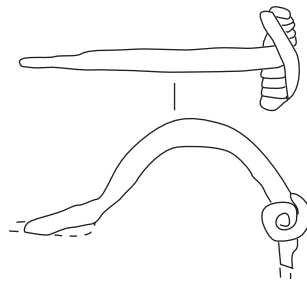

n°8 : fosse Q-P6.64

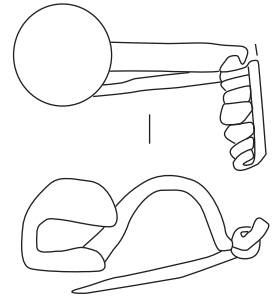

n°6 : III-N7.19

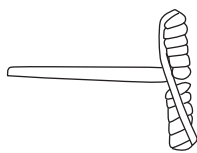

n°9 : III-Q5.100



n°10 : III-L8.80

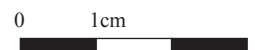

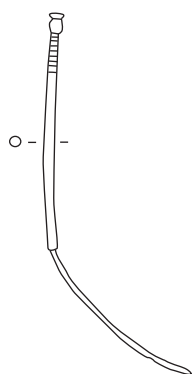

n°1 : III-Q7.43

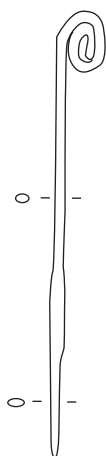

n°2 : L7/L8-L7.107



n°3 : III-M9.48



n°5 : III-M6.11

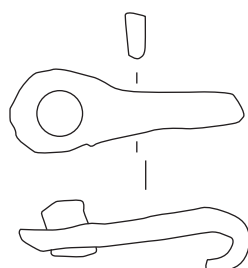

n°6 : fosse Q-Q6.98

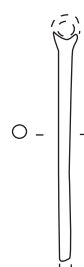

n°4 : III-L9.37

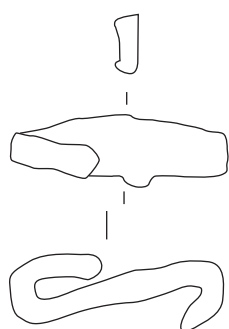

n°7 : III-N8.214

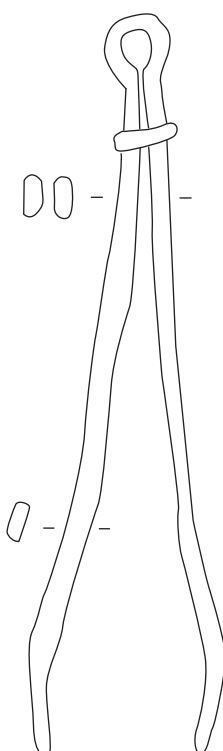

n°9 : III-N8.84

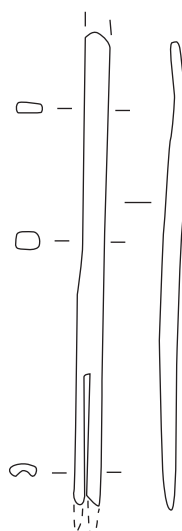

n°10 : III-N9.48

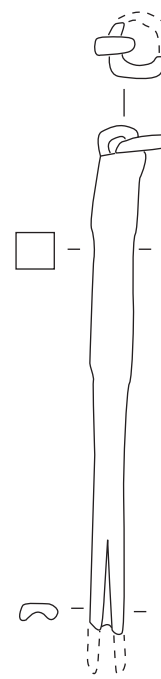

n°11 : N8.247

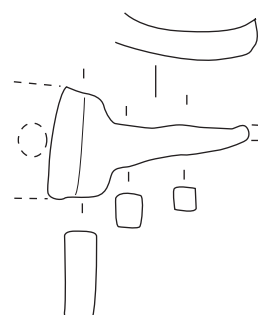

n°8 : III-O8.9

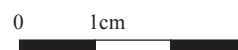

n°2-6 à 11 : fer sauf n°1-3-5 : bronze



I

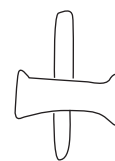

I



I

n°1 : III-O8.2



n°2 : L7/L8-  
L8.152

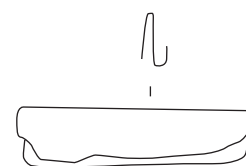

I



n°4 : III-O8.18

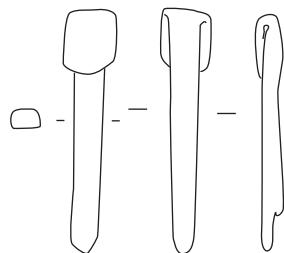

n°3 : III-07.42

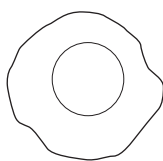

I

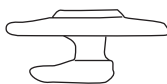

I

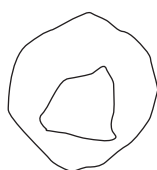

n°6 : III-N9.72



n°8 : III-O8.197

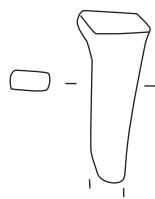

n°5 : III-M7.164

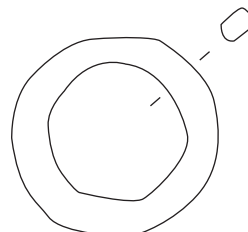

n°9 : III-O7.82

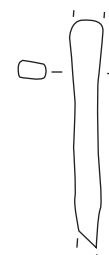

n°10 : III-O8.47

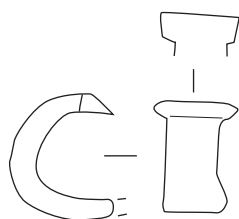

n°7 : III-N8.158

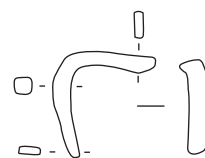

n°11 : fosse Q8.47

n°1-3-5 à 11 : fer sauf n°2-4 : bronze

0 1cm



Illfurth  
Britzgyberg-Buergelen

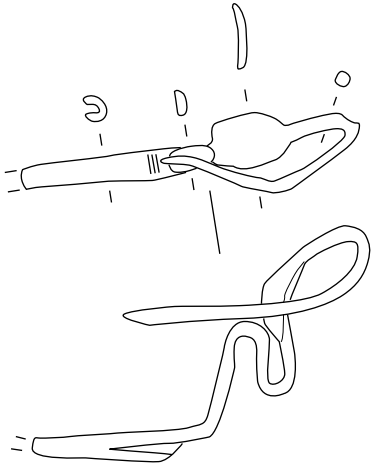

n°1 : 2005-St.11-n°2

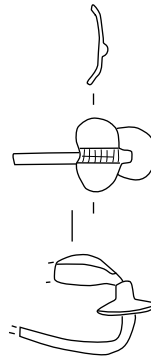

n°2 : 2005-St.15-n°13-P2

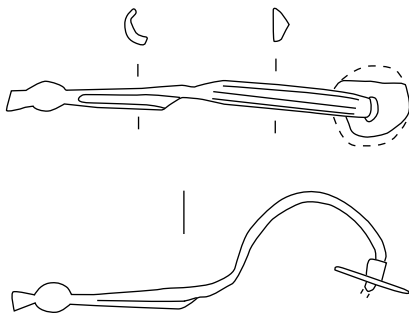

n°3 : 2005-St.15

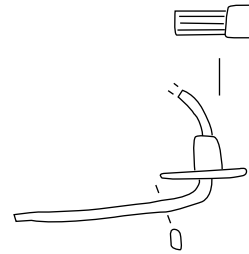

n°4 : 2005-St.15-n°6

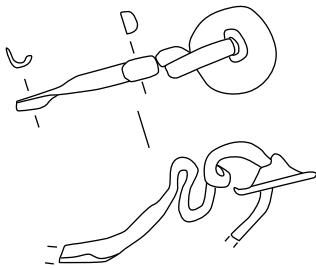

n°5 : 2005-St.15-n°3

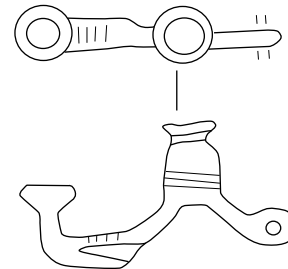

n°7 : 2005-St.285-P2

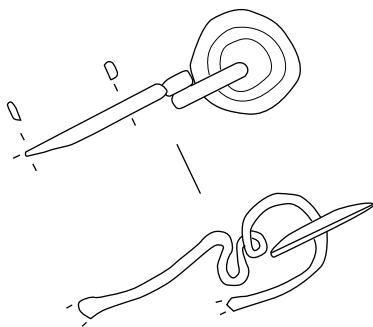

n°6 : 2005-St.15-n°5

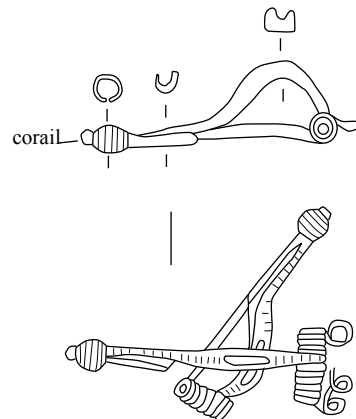

n°8 : 2005-St.15-n°4

n°1 à 8 : bronze

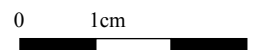

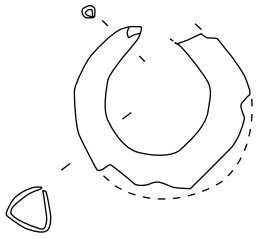

n°1 : 2005-St.373-P19

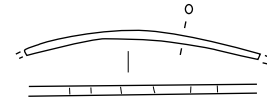

n°2 : 2005-St.15

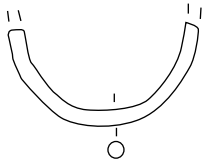

n°3 : 2005-St.15-n°7-décapage

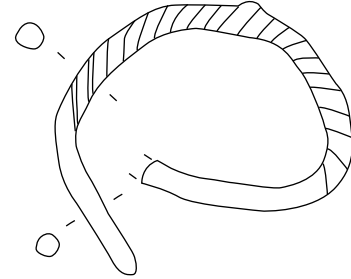

n°4 : 2005-St.291-P2

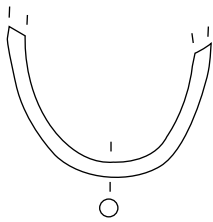

n°5 : 2005-St.267

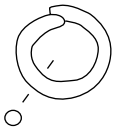

n°6 : 2005-St.15-n°12-P10



n°7 : 2005-St.305-n°1-P3



n°8 : 2005-St.15-n°19-P6

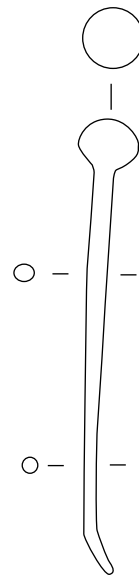

n°9  
D'après V. Rougier

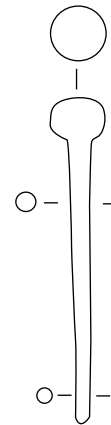

n°10  
D'après V. Rougier

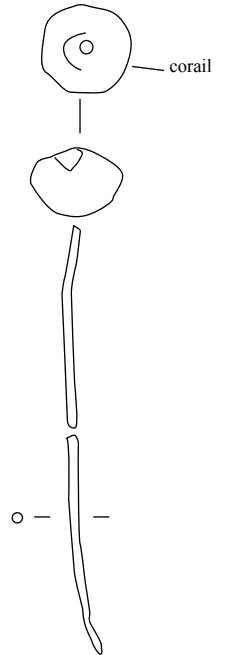

n°11  
D'après V. Rougier

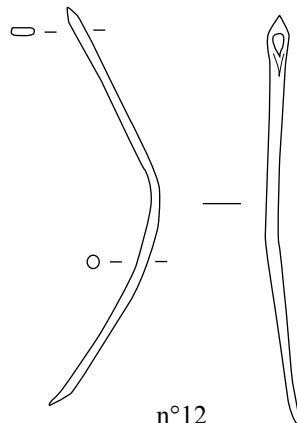

n°12



n°13

n°1 à 13 : bronze

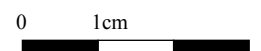



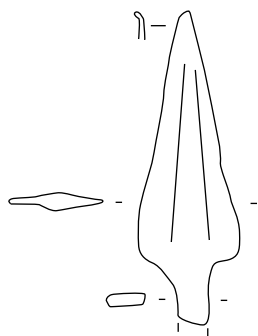

n°1 : 2005-St.15-n°17-P15

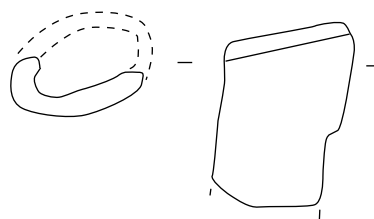

n°2 : 2005-St.287-n°1-P2

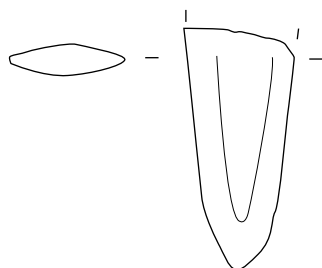

n°3 : 2005-St.9

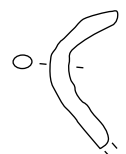

n°4 : 2005-St.15-n°18-P7

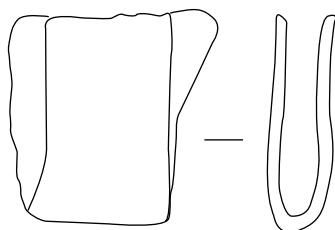

n°7 : 2005-St.364-n°1



n°5 : 2005-St.15-n°8-P6

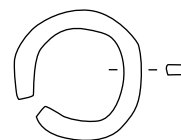

n°6 : 2005-St. 15-n°11-P13

n°1 à 7 : bronze

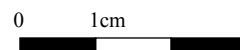

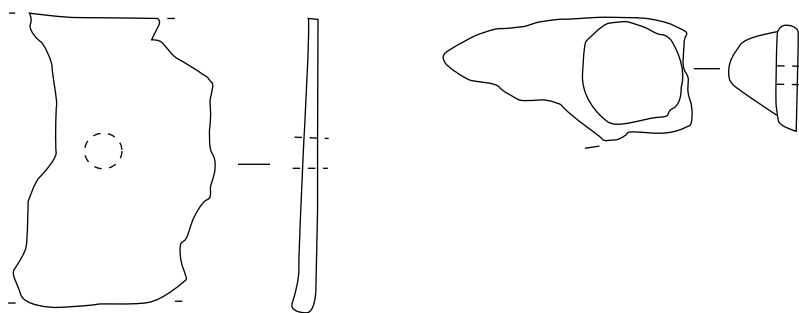

n°1 : 2005-St.15-P5

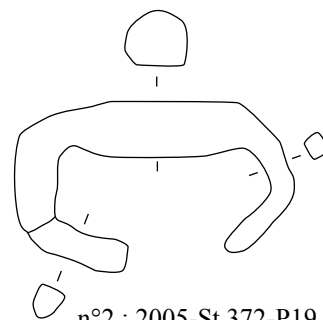

n°2 : 2005-St.372-P19

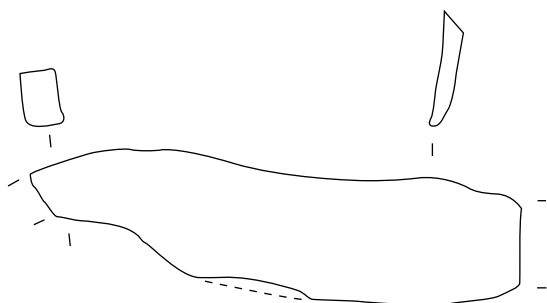

n°3 : 2005-St.15-décapage

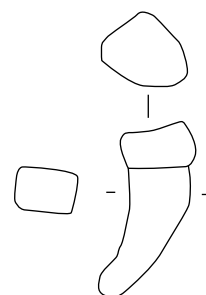

n°4 : 2005-St.372-P19

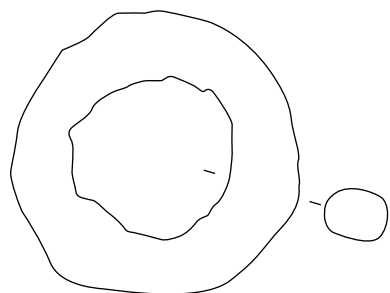

n°5 : 2005-St.264-n°1

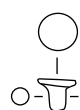

n°6 : 2005-St.15-n°14-P4

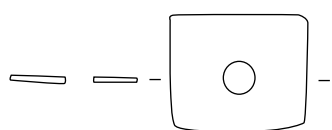

n°7 : 2005-St.15-n°21

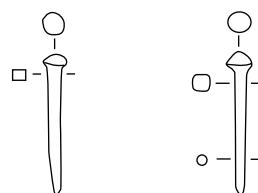

n°8 : 2005-St.308-n°1-P7

n°1 à 5 : fer sinon bronze

