



**HAL**  
open science

# An Integrated Process Planning System for Machining and Inspection

Yaoyao Fiona Zhao

► **To cite this version:**

Yaoyao Fiona Zhao. An Integrated Process Planning System for Machining and Inspection. Chemical and Process Engineering. University of Auckland, 2009. English. NNT : . tel-00726013

**HAL Id: tel-00726013**

**<https://theses.hal.science/tel-00726013>**

Submitted on 28 Aug 2012

**HAL** is a multi-disciplinary open access archive for the deposit and dissemination of scientific research documents, whether they are published or not. The documents may come from teaching and research institutions in France or abroad, or from public or private research centers.

L'archive ouverte pluridisciplinaire **HAL**, est destinée au dépôt et à la diffusion de documents scientifiques de niveau recherche, publiés ou non, émanant des établissements d'enseignement et de recherche français ou étrangers, des laboratoires publics ou privés.



THE UNIVERSITY OF AUCKLAND  
NEW ZEALAND

*An Integrated Process Planning System for  
Machining and Inspection*

*Yaoyao (Fiona) Zhao*

**A Thesis submitted in partial fulfilment of the requirements  
for the degree of Doctor of Philosophy in Engineering**

**December 2009**

Intelligent and Interoperable Manufacturing Systems Research Group

Department of Mechanical Engineering

Faculty of Engineering

University of Auckland



# *Abstract*

Due to the deterministic nature of manufacturing processes, measuring important process parameters and performing timely adjustment is an effective way to improve manufacturing efficiency and quality. In-process measurement is such a method. It is capable of monitoring manufacturing processes in real time. However, the current information flow between different manufacturing processes is segmented due to the lack of a consolidated data model to represent sufficient information of a product. This directly results in segmented process planning for in-process measurement. The establishment of STEP (STandard for Exchange of Product data) offers manufacturers a new method to exchange product data through the entire product lifecycle. As an extension to STEP, STEP-NC provides the potential to finally close the gap between design and manufacturing in the drive for a complete and integrated product development environment. The STEP/STEP-NC data model is a long overdue improvement in the domain of process planning for Computer Numerical Controlled (CNC) machining in the industry where G-codes have been in use for more than half a century. STEP/STEP-NC brings richer information to the CNC machining industry presenting an opportunity for the development of more intelligent, interoperable and informative machining processes.

The research work documented in this thesis introduces a consolidated STEP/STEP-NC data model and system for an automatic and integrated process planning system for machining, in-process measurement, and feedback. This research first developed the current STEP/STEP-NC data model with new definitions covering tolerance requirement information, and measurement operation information. A mechanism to link tolerance requirements and machining feature information was also developed to provide the crucial connection between machining and measurement.

With sufficient information provided by the proposed STEP data model, the concept of an integrated process planning system was conceived to carry out automated process planning for machining and in-process measurement. The system is able to analyse and select critical tolerance(s) from an input data file, generate measuring operation(s) for each

critical tolerance in-between machining operations. Measurement of each critical tolerance is also planned by the developed system including generating, allocating, and sequencing measurement points for each measuring operation. After the measurement results of each measuring operation are collected, the system analyses the results and provides proper adjustments to the immediate subsequent machining operation(s). A software prototype was developed to test the proposed data model and the integrated process planning and feedback concept.

The ultimate goal of performing measurement in a manufacturing system is to gain close control of the machining process based on tolerance requirements and to adjust process errors as they occur. The key issue is to connect machining and tolerance requirements. What to measure and when to measure is another critical issue. This research has made an attempt to address these issues in order to realize a long-awaited paradigm of automatic placement of measurement procedures in-between machining operations and provide automated process-intermittent feedback to the machining process.

The research work in this thesis has been reported in 3 published journal papers [1-3], 2 journal papers *in press* [4, 5], and presented at 2 international conferences [6, 7]. This research has also been carried out in collaboration with the U. S. National Institute of Standards and Technology where the author made two research visits.

# *Acknowledgements*

For the past three years, my life has been devoted to this research. It has been a rewarding journey: along the way I have stumbled but regained my footing, I have learnt and I have grown. Always, I have received support and encouragement from my supervisors, colleagues, friends, and my parents. Without them I would not have reached this point. I extend my appreciation and thanks to each of those people who helped me, cared about me and loved me.

Firstly, I offer a special thank you to my supervisor, Associate Professor Xun Xu, who gave me the opportunity to work on this exciting research project. His supervision, encouragement, and inspiration supported me all the way. His advice on doing research and on becoming a better person is invaluable to me. I am also thankful to my co-supervisor, Dr. Shane Xie, and the Advisory Committee members for their detailed and constructive comments.

Many thanks to Mr. Sarath Pathirana and Mr Ken Snow, the technicians at the Manufacturing Systems Laboratory, for their kind assistance, useful comments and prompt response toward my request.

I feel fortunate to have been part of such a vibrant research community – Intelligent & Interoperable Manufacturing Systems (IIMS) group – that enabled me to be benefited from interactions with a number of researchers in that group: Dr. Derek Wang, Mohamad Bin Minhat, Albert Yang, Salah Habeeb, Firman Ridwan, Aini Zuhra Abdul Kadir, Vincent Wang, and Dr. Matthieu Rauch. I would like to thank also Ian Yen-hung Chen from the Electrical and Computer Engineering Department for his help on the software development. I am thankful for and proud of the friendship I share with each of them.

Funding for this research project has been supplied by the University of Auckland Faculty of Engineering International Doctoral/Fees scholarship, Postgraduate Students Support (PReSS) funding, and New Zealand Postgraduate Study Abroad Award. Without their support, this project would not have happened.

## Acknowledgements

---

Lastly, I present this thesis as a special gift to my mother and father for their unflagging love and support through out my life. Had it not been for their ongoing encouragement and love, this thesis would have not been a reality. Throughout my life, they have done their uttermost to provide me with the best possible environment to grow up in, be it for attending school or studying overseas. My parents have always been there for me, both during my rebellious teenage years and later, supporting me and encouraging me every time I felt beset by difficulties, under pressure or feeling a bit down. I have no words adequate to fully describe my appreciation of their everlasting love for me. They are the best parents I could every ask for. This thesis is my special gift to them; I trust they will share this happiness with me. I will continue to do my best to be the daughter they are proud of.

Yaoyao Fiona Zhao

24 November 2009

# *List of Abbreviations*

|              |  |
|--------------|--|
| <b>AAG</b>   | <b>Attributed Adjacency Graph</b>                  |
| <b>AAM</b>   | <b>Application Activity Model</b>                  |
| <b>AIAG</b>  | <b>Automotive Industry Action Group</b>            |
| <b>AIM</b>   | <b>Application Interpreted Model</b>               |
| <b>AM</b>    | <b>Application Model</b>                           |
| <b>ANSI</b>  | <b>American National Standards Institute</b>       |
| <b>AP</b>    | <b>Application Protocol</b>                        |
| <b>API</b>   | <b>Application Programming Interface</b>           |
| <b>ARM</b>   | <b>Application Reference Model</b>                 |
| <b>ASME</b>  | <b>American Society of Mechanical Engineers</b>    |
| <b>ASQ</b>   | <b>American Society for Quality</b>                |
| <b>BS</b>    | <b>British Standard</b>                            |
| <b>CAD</b>   | <b>Computer-Aided Design</b>                       |
| <b>CAIPP</b> | <b>Computer-Aided Inspection Process Planning</b>  |
| <b>CAM</b>   | <b>Computer-Aided Manufacturing</b>                |
| <b>CAPP</b>  | <b>Computer-Aided Process Planning</b>             |
| <b>CAVES</b> | <b>Computer Aided Valid Expert System</b>          |
| <b>CLM</b>   | <b>Closed-loop Manufacturing</b>                   |
| <b>CMM</b>   | <b>Coordinate Measuring Machine</b>                |
| <b>CMC</b>   | <b>Canonical Machining Commands</b>                |
| <b>CNC</b>   | <b>Computer Numerical Controlled</b>               |
| <b>DMIS</b>  | <b>Dimensional Measuring Interface Standard</b>    |
| <b>DML</b>   | <b>Dimensional Markup Language</b>                 |
| <b>DMSC</b>  | <b>Dimensional Metrology Standard Consortium</b>   |
| <b>EB</b>    | <b>Error Budget</b>                                |
| <b>EMC</b>   | <b>Enhanced Machine Controller</b>                 |
| <b>EWEDS</b> | <b>Extended Winged Edge Data Structure</b>         |
| <b>FBICS</b> | <b>Feature-Based Inspection and Control System</b> |

|                 |   |
|-----------------|---|
| <b>FTP</b>      | <b>File Transfer Protocol</b>                                 |
| <b>GCAPPSS</b>  | <b>Genetic Computer-Aided Process Planning Support System</b> |
| <b>GD&amp;T</b> | <b>Geometric and Dimensional Tolerancing</b>                  |
| <b>GOIS</b>     | <b>Genetic Object Information System</b>                      |
| <b>GSL</b>      | <b>GNU Scientific Library</b>                                 |
| <b>HIPP</b>     | <b>High-level Inspection Process Planning</b>                 |
| <b>HTTP</b>     | <b>Hyper Text Transfer Protocol</b>                           |
| <b>I++DME</b>   | <b>Inspection++ Dimensional Measurement Equipment</b>         |
| <b>IDE</b>      | <b>Integrated Development Environment</b>                     |
| <b>IDEF0</b>    | <b>Integration DEfinition for Function Modelling</b>          |
| <b>IGES</b>     | <b>Initial Graphics Exchange Specification</b>                |
| <b>IIMS</b>     | <b>Intelligent and Interoperable Manufacturing Systems</b>    |
| <b>IPF</b>      | <b>Inspection Plan Fragments</b>                              |
| <b>IPIM</b>     | <b>Integrated Product Information Model</b>                   |
| <b>IPPEX</b>    | <b>Inspection Process Planning EXpert system</b>              |
| <b>IS</b>       | <b>International Standards</b>                                |
| <b>ISO</b>      | <b>International Organization for Standardization</b>         |
| <b>MEPT</b>     | <b>MEtrology Project Team</b>                                 |
| <b>MFC</b>      | <b>Microsoft Foundation Classes</b>                           |
| <b>MMC</b>      | <b>Maximum Material Condition</b>                             |
| <b>NIST</b>     | <b>National Institute of Standards and Technology</b>         |
| <b>NURBS</b>    | <b>Non-Uniform Rotational B-Spline</b>                        |
| <b>OMM</b>      | <b>On-machine Measurement</b>                                 |
| <b>PLM</b>      | <b>Product Lifecycle Management</b>                           |
| <b>PMI</b>      | <b>Product Manufacturing Information</b>                      |
| <b>POM</b>      | <b>Probe Orientation Module</b>                               |
| <b>QMD</b>      | <b>Quality Measurement Data</b>                               |
| <b>RDS</b>      | <b>Rapid Design System</b>                                    |
| <b>SC</b>       | <b>Sub-Committee</b>  |
| <b>SDAI</b>     | <b>STEP Data Access Interface</b>                             |
| <b>STEP</b>     | <b>STandards for Exchange of Product data</b>                 |
| <b>STEP-NC</b>  | <b>STEP data model for Computerized Numerical Controllers</b> |



|             |  |
|-------------|--|
| <b>STL</b>  | <b>ST</b> ereo <b>L</b> ithography                             |
| <b>TC</b>   | <b>T</b> echnical <b>C</b> ommittee                            |
| <b>TSP</b>  | <b>T</b> ravelling <b>S</b> ales <b>P</b> erson                |
| <b>UOF</b>  | <b>U</b> nits of <b>F</b> unction                              |
| <b>VGM</b>  | <b>V</b> irtual <b>G</b> ear <b>M</b> odel                     |
| <b>VRML</b> | <b>V</b> irtual <b>R</b> eality <b>M</b> odel <b>L</b> anguage |
| <b>XML</b>  | <b>eX</b> tensible <b>M</b> arkup <b>L</b> anguage             |

---

# *Table of Content*

|   |              |
|---|--------------|
| <b>Abstract .....</b>   | <b>i</b>     |
| <b>Acknowledgements.....</b>  | <b>iii</b>   |
| <b>List of Abbreviations.....</b>                                       | <b>v</b>     |
| <b>Table of Content .....</b>   | <b>viii</b>  |
| <b>List of Figures .....</b>  | <b>xiii</b>  |
| <b>List of Tables.....</b>  | <b>xviii</b> |
| <b>Chapter 1 Introduction.....</b>                                      | <b>1</b>     |
| <b>1.1. Closed-loop Manufacturing .....</b>                             | <b>2</b>     |
| <b>1.2. Process Variations and Error Resources.....</b>                 | <b>6</b>     |
| <b>1.3. In-process Measurement.....</b>                                 | <b>9</b>     |
| <b>1.4. Measurement Sensors.....</b>                                    | <b>13</b>    |
| <b>1.5. Information and Data Model for In-process Measurement .....</b> | <b>15</b>    |
| <b>1.6. Recap.....</b>  | <b>16</b>    |
| <b>1.7. Thesis Organization.....</b>                                    | <b>16</b>    |
| <b>Chapter 2 Literature Review .....</b>                                | <b>19</b>    |
| <b>2.1. Review on CAIPP Systems.....</b>                                | <b>20</b>    |
| 2.1.1. Early Research (Prior to 1995) on CAIPP .....                    | 21           |
| 2.1.1.1. <i>Tolerance-driven CAIPP Systems</i> .....                    | 21           |
| 2.1.1.2. <i>Geometry-based CAIPP Systems</i> .....                      | 25           |
| 2.1.2. Recent CAIPP Research for OMM and CMM.....                       | 26           |
| 2.1.2.1. <i>Inspection Feature Selection and Sequencing</i> .....       | 27           |

---

|  |               |
|--|---------------|
| 2.1.2.2. <i>Measurement/Sampling Points Selection and Optimization</i> .....       | 30            |
| 2.1.2.3. <i>Probing Path Planning and Generation</i> .....                         | 33            |
| 2.1.3. Review of CAIPP Systems for OMM .....                                       | 35            |
| <b>2.2. Recap of CAIPP Review</b> .....  | <b>40</b>     |
| <b>2.3. Dimensional Metrology Interoperability Issues</b> .....                    | <b>45</b>     |
| 2.3.1. Product Definition .....  | 47            |
| 2.3.2. Measurement Process Definition .....  | 48            |
| 2.3.3. Measurement Process Execution .....   | 50            |
| 2.3.4. Analysis and Report .....   | 51            |
| 2.3.5. Crosscutting Interoperability Issues in Dimensional Metrology Systems ..... | 53            |
| 2.3.6. Recap of Dimensional Metrology Interoperability Issues .....                | 54            |
| <b>2.4. Recap</b> .....  | <b>56</b>     |
| <br><b>Chapter 3 STEP and STEP-NC</b> .....  | <br><b>58</b> |
| <br><b>3.1. A Snapshot of STEP</b> .....   | <br><b>58</b> |
| 3.1.1. Overview of STEP.....   | 58            |
| 3.1.2. History of STEP .....   | 59            |
| 3.1.3. Objectives of STEP .....  | 61            |
| <b>3.2. Structure and Technical Details of STEP</b> .....                          | <b>61</b>     |
| 3.2.1. Description Methods .....   | 63            |
| 3.2.2. STEP Implementation Methods .....   | 65            |
| 3.2.3. Part 21 Physical File Implementation Method .....                           | 66            |
| 3.2.4. STEP Data Access Interface.....   | 67            |
| 3.2.5. XML Files .....   | 69            |
| 3.2.6. Application Protocols .....   | 69            |
| 3.2.6.1. <i>Application Activity Model</i> .....                                   | 69            |
| 3.2.6.2. <i>Application Reference Model</i> .....                                  | 70            |
| 3.2.6.3. <i>Application Interpreted Model</i> .....                                | 71            |
| 3.2.6.4. <i>Other Documentation Strategies of AP</i> .....                         | 71            |
| 3.2.7. STEP Integrated Resources .....   | 72            |
| <b>3.3. STEP-NC</b> .....  | <b>72</b>     |

|   |            |
|---|------------|
| 3.3.1. Information Content and Structure .....  | 74         |
| 3.3.2. ARM vs. AIM in STEP-NC .....   | 78         |
| <b>3.4. Recap.....</b>  | <b>79</b>  |
| <br>  |            |
| <b>Chapter 4 Proposed STEP Data Model .....</b>   | <b>81</b>  |
| <br>  |            |
| <b>4.1. STEP/STEP-NC Related Research on CAIPP and Standard Development.....</b>                              | <b>81</b>  |
| 4.1.1. Overview of STEP/STEP-NC Related CAIPP Research .....  | 82         |
| 4.1.2. CAIPP Related STEP/STEP-NC Standard Development .....  | 85         |
| <b>4.2. Proposed STEP ARM Data Model for Integrated CNC Machining and<br/>Inspection .....</b>                | <b>87</b>  |
| 4.2.1. AAM Model of Integrated Machining and In-process Measurement Process<br>Planning System .....          | 87         |
| 4.2.2. Proposed STEP Application Protocol ARM Data Model for Integrated CNC<br>Machining and Inspection ..... | 93         |
| 4.2.3. GD&T Data Definitions .....  | 102        |
| 4.2.4. Measurement Technological Information Definitions .....  | 111        |
| <b>4.3. Recap.....</b>  | <b>113</b> |
| <br>  |            |
| <b>Chapter 5 Proposed Integrated Process Planning System.....</b>   | <b>114</b> |
| <br>  |            |
| <b>5.1. Integrated Process Planning and Feedback System.....</b>  | <b>117</b> |
| <b>5.2. Measurement Geometry Selection/Creation System.....</b>   | <b>119</b> |
| 5.2.1. Tolerance Filter .....   | 119        |
| 5.2.2. Measurement Geometry Decision Rules .....  | 121        |
| 5.2.2.1. <i>Form Tolerances</i> .....   | 128        |
| 5.2.2.2. <i>Orientation Tolerances</i> .....  | 128        |
| 5.2.2.3. <i>Location Tolerances</i> .....   | 129        |
| <b>5.3. Workingstep Re-sequencing .....</b>   | <b>134</b> |
| <b>5.4. Micro Inspection Process Planning.....</b>  | <b>136</b> |
| 5.4.1. Measurement Points Generation and Distribution .....   | 136        |
| 5.4.2. Feature Interaction Detection .....  | 140        |
| 5.4.3. Measurement Points Reallocation and Re-sequence .....  | 145        |

|   |            |
|---|------------|
| <b>5.5. Measurement Result Analysis and Feedback .....</b>              | <b>146</b> |
| 5.5.1. Data Fitting Algorithms.....                                     | 147        |
| 5.5.1.1. <i>Mathematical Representation of Geometric Elements</i> ..... | 147        |
| 5.5.1.2. <i>Data Fitting Criteria</i> .....                             | 149        |
| 5.5.2. Tolerance Zone Analysis and Feedback Update .....                | 152        |
| <b>5.6. Recap.....</b>  | <b>154</b> |
| <br>  |            |
| <b>Chapter 6 System Implementation and Case Studies.....</b>            | <b>156</b> |
| <br>  |            |
| <b>6.1. Software Development Environment and Tools.....</b>             | <b>156</b> |
| 6.1.1. Microsoft Visual Studio and Microsoft Foundation Class®.....     | 157        |
| 6.1.2. ST-Developer™.....   | 157        |
| 6.1.3. Open CASCADE®.....   | 161        |
| 6.1.4. GNU Scientific Library .....                                     | 163        |
| <b>6.2. STEP-INSPEC Software Prototype.....</b>                         | <b>163</b> |
| 6.2.1. Implementation Environmental Setting.....                        | 164        |
| 6.2.2. STEP-INSPEC Software .....                                       | 166        |
| 6.2.3. STEP-INSPEC Software Information Flow .....                      | 169        |
| <b>6.3. Case Studies.....</b>   | <b>172</b> |
| 6.3.1. Case Study 1 .....   | 173        |
| 6.3.2. Cast Study 2.....  | 178        |
| <b>6.4. Recap.....</b>  | <b>183</b> |
| <br>  |            |
| <b>Chapter 7 Conclusions and Future Work.....</b>                       | <b>185</b> |
| <br>  |            |
| <b>References .....</b>   | <b>192</b> |
| <br>  |            |
| <b>Appendix A EXPRESS-G Diagram of Proposed Data Model .....</b>        | <b>204</b> |
| <br>  |            |
| <b>Appendix B STEP-NC programs.....</b>                                 | <b>208</b> |
| <br>  |            |
| <b>Appendix B.1 ISO 14649 Part 11 Example 1.....</b>                    | <b>209</b> |
| <b>Appendix B.2 Fish-head Roughing Example .....</b>                    | <b>213</b> |

|                   |   |            |
|-------------------|---|------------|
| <b>Appendix C</b> | <b>STEP-INSPEC Software Output Files.....</b>   | <b>221</b> |
| Appendix C.1      | CMC Output of Fish-head Roughing Example .....  | 222        |
| Appendix C.2      | G-code Output .....                             | 234        |
| Appendix C.3      | Newly Generated STEP Part 21 File .....         | 245        |
| <br>              |   |            |
| <b>Appendix D</b> | <b>Abstracts of Research Publications .....</b> | <b>254</b> |
| Appendix D.1      | Journal Publication (6-1) .....                 | 256        |
| Appendix D.2      | Journal Publication (6-2) .....                 | 257        |
| Appendix D.3      | Journal Publication (6-3) .....                 | 258        |
| Appendix D.4      | Journal Publication (6-4) .....                 | 259        |
| Appendix D.5      | Journal Publication (6-5) .....                 | 260        |
| Appendix D.6      | Journal Publication (6-6) .....                 | 261        |
| Appendix D.7      | Conference Publication (2-1) .....              | 262        |
| Appendix D.8      | Conference Publication (2-2) .....              | 263        |

# *List of Figures*

|   |    |
|---|----|
| Figure 1: Elements of CLM.....  | 3  |
| Figure 2: Six error elements in linear axis motions.....  | 8  |
| Figure 3: Concept of in-process measurement .....   | 10 |
| Figure 4: Sensor application versus level of precision and error control parameters [19]..              | 14 |
| Figure 5: An expert inspection planning system model [25] .....   | 22 |
| Figure 6: An inspection control hierarchy.....  | 23 |
| Figure 7: The role of CAIP and the inter-relations between CAD/CAI/CAM.....                             | 25 |
| Figure 8: Flowchart of the feature-based inspection process planning system.....                        | 28 |
| Figure 9: CATIP system structure [53] .....   | 29 |
| Figure 10: Flowchart of the collision free probing path generation.....                                 | 34 |
| Figure 11: CAIPP system using (a) CMM and (b) OMM.....  | 36 |
| Figure 12: Framework of GCAPPSS .....   | 37 |
| Figure 13: The overall schematic structure of OMM process planning.....                                 | 39 |
| Figure 14: IDEF0 model of dimensional metrology system .....  | 42 |
| Figure 15: IDEF0 diagram of measurement process definition activity .....                               | 43 |
| Figure 16: Interoperability barriers between dimensional metrology commercial software<br>systems ..... | 45 |
| Figure 17: Current-state dimensional metrology interoperability issues .....                            | 46 |
| Figure 18: The current metrology interoperability standard landscape [83].....                          | 54 |
| Figure 19: Future vision of dimensional metrology system.....   | 55 |
| Figure 20 Design – manufacturing data exchange enabled by STEP.....                                     | 60 |

## List of Figures

---

|  |     |
|--|-----|
| Figure 21: Structure of the STEP standard [20] .....                             | 62  |
| Figure 22: An example of EXPRESS schema .....                                    | 64  |
| Figure 23: An example of EXPRESS-G diagram .....                                 | 66  |
| Figure 24: An example of Part 21 file .....                                      | 68  |
| Figure 25: An AAM for digital manufacturing [21].....                            | 70  |
| Figure 26: Design – manufacturing chain enabled by STEP-NC.....                  | 73  |
| Figure 27: Comparison of G&M code and STEP-NC data .....                         | 75  |
| Figure 28: Structure of the STEP-NC data model [21] .....                        | 76  |
| Figure 29: Structure of a STEP-NC program .....                                  | 77  |
| Figure 30: Relationships between ISO 14649 and STEP APs [125].....               | 79  |
| Figure 31: Prototype implementation of the STEP-NC enabled CLM [129].....        | 83  |
| Figure 32: Research on STEP/STEP-NC enabled inspection systems (2001-2008).....  | 86  |
| Figure 33: A0 level AAM model for the integrated process planning system.....    | 88  |
| Figure 34: A0 activities in the integrated process planning AAM model.....       | 89  |
| Figure 35: A1 activities in the integrated process planning AAM model.....       | 90  |
| Figure 36: A11 activities in the integrated process planning AAM model.....      | 91  |
| Figure 37: A12 activities in the integrated process planning AAM model.....      | 92  |
| Figure 38: A2 activities in the integrated process planning AAM model.....       | 93  |
| Figure 39: Information defined in ISO 14649 Parts 10, 11, 12, 111, and 121 ..... | 95  |
| Figure 40: Dimensional measurement related information definitions.....          | 98  |
| Figure 41: EXPRESS-G diagram of dimensional measurement features .....           | 100 |
| Figure 42: GD&T definitions in the proposed data model.....                      | 104 |
| Figure 43: Datum information definitions.....                                    | 106 |
| Figure 44: Relationship between machining features and tolerances .....          | 107 |



Figure 45: Illustration of feature and toleranced\_geomtry ..... 108

Figure 46: Toleranced geometry definitions ..... 109

Figure 47: Illustration of value\_qualifier attribute ..... 110

Figure 48: Measurement result and measurement strategy definitions ..... 112

Figure 49: Measurement technology and measurement machine function definitions ..... 112

Figure 50: Proposed STEP-based CLM system architecture ..... 115

Figure 51: Proposed integrated process planning system framework ..... 118

Figure 52: Machine accuracy information ..... 120

Figure 53: Form deviation, orientational deviation, and locational deviation ..... 125

Figure 54: Information linkage between machining, tolerance, and features ..... 126

Figure 55: Difference between a machining feature and a measurement geometry ..... 126

Figure 56: Parallelism tolerance of a cylinder axis ..... 127

Figure 57: Positional tolerancing for symmetrical features ..... 130

Figure 58: Symmetry tolerancing for symmetrical features ..... 130

Figure 59: Measurement geometry decision making algorithm ..... 132

Figure 60: Measurement geometry selection algorithm ..... 133

Figure 61: Distribution of points on rectangular plane ..... 138

Figure 62: A distribution of points on a cylinder ..... 139

Figure 63: Round hole defined in STEP-NC standard [118] ..... 140

Figure 64: Illustration of feature interaction ..... 141

Figure 65: Feature interaction detection zones for closed pocket feature ..... 143

Figure 66: Feature interaction zones for step feature ..... 143

Figure 67: Feature interaction detection algorithm flowchart for closed pocket feature .. 144

Figure 68: Measurement points reallocation algorithm ..... 146

|   |     |
|---|-----|
| Figure 69: ST-Developer™ architecture .....   | 158 |
| Figure 70: Compiling EXPRESS source for use in application program.....   | 159 |
| Figure 71: Converting STEP EXPRESS schema into C++ classes and ROSE schema files<br>.....   | 160 |
| Figure 72: Open CASCADE® software platform structure.....   | 161 |
| Figure 73: STEP-INSPEC software library and additional directory setup .....  | 165 |
| Figure 74: STEP-INSPEC input interface .....  | 166 |
| Figure 75: STEP-INSPEC software input and output interface .....  | 167 |
| Figure 76: STEP-INSPEC system outputs and tree-view .....   | 168 |
| Figure 77: Four elements of STEP-INSPEC software system and their program files.....  | 170 |
| Figure 78: STEP-INSPEC software prototype system flowchart.....   | 171 |
| Figure 79: ISO 14649 Part 11 Example 1.....   | 173 |
| Figure 80: Dimensions and tolerances of the example.....  | 174 |
| Figure 81: Case study software output .....   | 175 |
| Figure 82: Machining and inspection workingsteps combined.....  | 176 |
| Figure 83: Machined workpiece of Example 1 .....  | 178 |
| Figure 84: Second case study workpiece and its machining_workingsteps.....  | 179 |
| Figure 85: Second case study drawing .....  | 180 |
| Figure 86: STEP-INSPEC software output for the second case study .....  | 182 |
| Figure 87: Machined workpiece of the second case study .....  | 183 |
| Figure 88: EXPRESS-G diagram of proposed GD&T, datum, and toleranced geometry<br>definitions.....   | 205 |
| Figure 89: EXPRESS-G diagram of proposed measurement workingstep, operation,<br>technology, strategy, machine function, result definitions..... | 206 |

## List of Figures

---

|   |     |
|---|-----|
| Figure 90: EXPRESS-G diagram of proposed dimensional measurement feature definitions<br>..... | 207 |
| Figure 91: ISO 14649 Part 11 Example 1.....   | 209 |
| Figure 92: Fish-head roughing example.....  | 213 |

# *List of Tables*

|  |     |
|--|-----|
| Table 1: Types of measurement and their properties [11].....                     | 4   |
| Table 2: Summary of research on measurement points sampling.....                 | 31  |
| Table 3: Machine tool database used in the case study.....                       | 121 |
| Table 4: Symbols for geometric characteristics .....                             | 123 |
| Table 5: Minimum number of measurement points on each basic features [143] ..... | 137 |
| Table 6: Geometric tolerances and their tolerance zone.....                      | 153 |

# *Chapter 1 Introduction*

Manufacturing operations are driven by cost requirements that relate to the value of a particular product to the marketplace. Given this selling price, the system works backwards to determine what resources can be allocated to the manufacturing portion of the cost equation. Then, production personnel set up the necessary resources and provide the workpieces that are consumed by the market. Everyone is happy until something changes. Unfortunately, the time constant associated with change in the manufacturing world has become very short. Requirements often change even before a system begins producing parts, and even after production is underway there are typically many sources of variability that impact on the cost/quality of the operation. Variability associated with scheduling changes are to be accommodated by designing flexibility into the basic manufacturing systems. However, the variability that is related to changing process conditions are best handled by altering system performance at a more basic level.

Error conditions often occur where one or more process parameters deviates significantly from the expected value and the process quality degrades. The sensitivity of the process to these variations in operation conditions depends on the point in the overall manufacturing cycle at which they occur as well as the specific characteristics of a particular process disturbance. Amplitude, a frequency of occurrence, and a direction typically characterize these process errors [8, 9]. In a machining operation, the typical result is a lack of synchronization between the tool and part locations so that erroneous dimensions are produced.

Over time, the amplitude of process errors is typically limited to a specific range either by their inherent nature or by the operator's actions. For example, shop temperature profiles tend to follow a specific pattern related to cutting forces, and cutting tools are replaced as they wear out. As multiple process error sources interact, the result is typically a seemingly random distribution of performance characteristics with a given "normal range" that defines the routine tolerances achievable within a given set of operations. On the other

hand, trends such as increased operating temperatures due to a heavy workload, coolant degradation, and machine tool component wear, have a non-random pattern that continue over time until an adjustment is made [8].

One solution to the problem of process variation is to build a system that is insensitive to all disturbances; unfortunately, this is rarely practical. A more realistic approach is to use a manufacturing model that defines the appropriate response to a particular process parameter change. This technique can be very successful if the necessary monitoring systems are in place to measure what is really happening within the various manufacturing operations. This approach works because manufacturing processes are deterministic in nature: a cause-and-effect relationship exists between the output of the process and the process parameters [8]. Events occur due to specific causes, not random chance, even though an observer may not recognize the driving force behind a particular action. If the key process characteristics are maintained at a steady-state level, then the process output will also remain relatively constant. Conversely, when the process parameters change significantly, the end product is also affected in a noticeable manner. By measuring the important process parameters in real time and performing appropriate adjustments in the system commands, great improvements can be achieved in increasing product quality and lowering production costs [9]. Closed-Loop Manufacturing (CLM) as such a method is widely employed in modern industry.

### **1.1. Closed-loop Manufacturing**

Closed-loop manufacturing is a method for optimizing the efficiency of a manufacturing process. It involves the use of measurement technology (metrology), most often touch sensor probes, to determine actual part dimensions as well as coordinates of machine tool characteristics [10]. The elements of CLM are comprised of reliable machines, robust processes, automatic data collection, continuous improvement, and efficient and accurate analysis. Each element is supported by various methods which when combined deliver a complete closed-loop solution. The CLM cycles consist of measurement, data collection, data analysis, and process adjustment. Figure 1 illustrates these elements and the cycle of CLM.

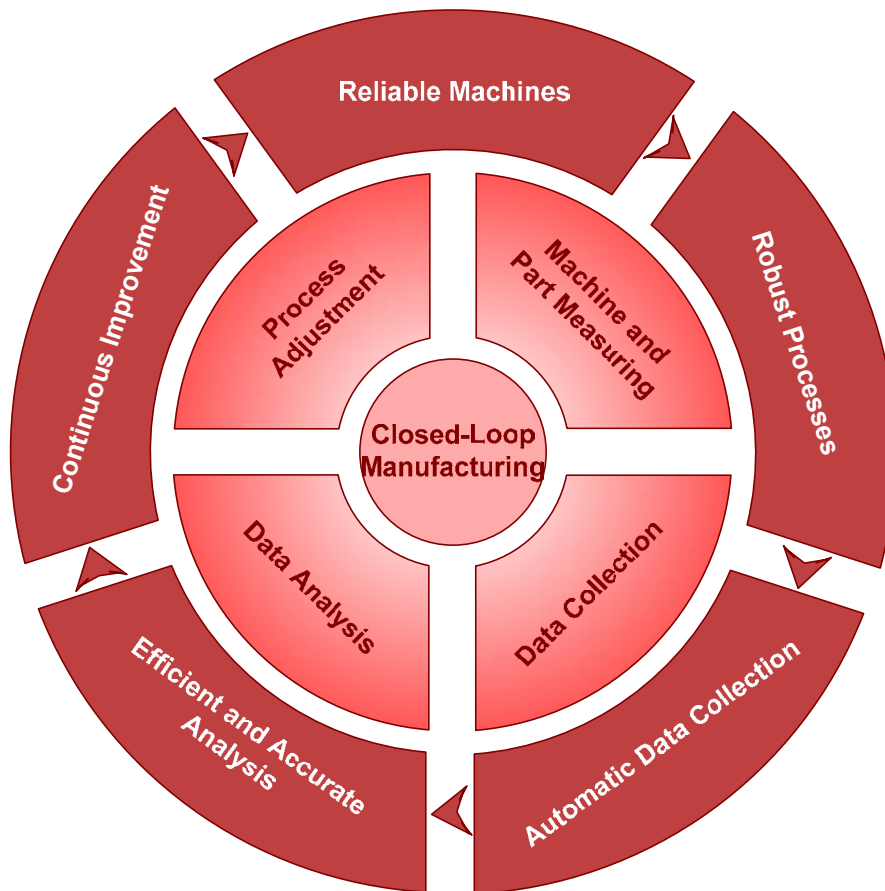

**Figure 1: Elements of CLM**

The loop is closed when the measurements are controlled and when they are utilized to improve the manufacturing process. The data that is collected during the measurements is the basis for various kinds of optimization loops targeting different aspects of manufacturing process. This data is not only used and applied within the machine’s control when adjusting offsets, but also utilized by engineers who analyze the process data over time to evaluate retargeting of dimensions, to modify tolerance requirements or to use the gained knowledge to better design parts for their producability. The benefits of utilizing CLM for manufacturing processes can be summarized as follows:

- 1) improving the reliability of the machine,
- 2) providing a more controlled environment,
- 3) lessening the human error involved with offset modification,
- 4) providing assurance of an acceptable accuracy level of the machinery, and
- 5) providing automate workpiece setup and tool setup.

Using the measurement of workpiece as a check on the CLM process is well established but there are a number of issues as to where to measure, what to measure and when to measure. There are three types of measurement in manufacturing processes listed as follows, all of which can be used to provide measurement data for CLM processes. These types of measurement and their properties are also summarized in Table 1 [11].

**Table 1: Types of measurement and their properties [11]**

|                           |   |                                |                                |
|---------------------------|---|--------------------------------|--------------------------------|
| Where?                    | In-process                                    | In situ                        | Remote                         |
| What type of measurement? | Dynamic                                       | Static                         | Integrated                     |
| Type of control           | Adaptive control                              | Statistical control            | Long-term traceability         |
| Information obtained      | Very specific                                 | Medium                         | Comprehensive surface geometry |
| Information required      | Process control                               | Process monitor                | Machine tool monitor           |
| Speed                     | Very fast<br><br>Few/No operator intervention | Time to record and judge       | Functional judgment            |
| Outcome                   | Working shift controlled                      | Quality of conformance assured | Quality of design assured      |

1) In-process measurement

- i) with On-Machine Measurement (OMM), which takes place as the workpiece is being made.
- ii) with portable measurement, where the workpiece surface is tested when the part has been made but not relocated. The surface instrument, which is hand-held, has somehow to be perched on the part when the machining has stopped and then the measurement recorded.



### 2) In situ measurement

The workpiece is removed from the machine and measured with an instrument located near the machine tool.

### 3) Remote measurement

The workpiece is taken to a properly equipped inspection room to be inspected on a Coordinate Measuring Machine (CMM).

Different types of CLM systems utilize different measurement operations to collect data. There are three types of CLM loops in a manufacturing system.

### 1) Process Control Loop

An immediate closed loop exists between the machine tool and the measuring system. The CNC program takes measurements instantly after one machining operation, compares the results to tolerance limits and adjusts offsets to compensate for the deviation between the actual and the desired state. In-process measurement is commonly employed for this type of closed-loop.

### 2) Process Improvement Loop

The process improvement loop is neither automated nor instant after machining but depends on the manufacturing engineer evaluating the process. Part dimensional data that was collected from the manufacturing process over a period of time provides an understanding of how well the process repeats and how accurate it is. In situ measurements are commonly used for this type of closed-loop, however, in-process measurement data is also considered for evaluation.

### 3) Design-for-Manufacturability Loop

If interpreted from a design engineering perspective, process data can tell how well and how easy certain features can be produced. A dissatisfying process capability causes scrap, rework, and repair. Some part features are easier to machine than others. The

design-for-manufacturability loop suggests that the design engineer analyses manufacturing process data to consider the degree of difficulty in producing one feature over another. Providing that fit, form and function of the feature are not compromised, the feature offering the better manufacturability may be preferred. Obviously, other considerations such as assemblability and cost influence should be considered by design engineers as well. In this type of closed loop, remote measurements are commonly used. Data collected through in-process measurement and in situ measurement is also utilized for analysis for this type of closed-loop.

Among the above three types of CLM systems, process control loop is the most important one and is of primary consideration of this research. Only when a manufacturing system is adaptive and stable enough, can it provide high quality parts for the rapidly changing modern manufacturing industry. An important goal of the manufacturing system with a process control loop is to reduce process variability and bias to as small a level as is economically justifiable. Process bias is the difference between a parameter's average value and its designed value. Bias errors are a steady-state deviation from an intended target and while they do cause unacceptable produce, they can be dealt with through calibration procedures. On the other hand, process variability is a continuously changing phenomenon that is caused by alterations in one or more manufacturing process parameters. It is inherently unpredictable and therefore more difficult to accommodate. However, the real-time process parameter measurements in CLM can provide the information needed to deal with unexpected excursions in manufacturing systems. The concept of conventional CLM is not a complex concept, however, the collection of the necessary process data can be a challenge. To decide when and where to conduct in-process measurement for collecting necessary process data, it is important to understand common process variation and error resources in manufacturing systems.

### **1.2. Process Variations and Error Resources**

Process variability hinders the efforts of system operators to control the quality and cost of manufacturing operations. This basic manufacturing characteristic is caused by the inability of a manufacturing system to do the same thing at all times and under all conditions. Machining operations typically exhibit a much higher degree of process

control. However, variability is still present in relatively simple operations such as attempting to control a feature's diameter and surface finish without maintaining a constant depth of cut, coolant condition, temperature, tooling quality, etc. Inspecting parts and monitoring the value or various process parameters under different operating conditions helps collect process variability data. However, the following questions must be answered before qualifying the process variability: what parameters can and should be measured; when should measurement take place; how much variation is acceptable; is bias a problem (it is usually a calibration issue); what supporting inspection data is required; and does the process model accurately predict the system operation? In industry, Error Budgets (EB) method [9] is commonly used to answer most of these questions. It categorizes system errors and understands the impact of altering the magnitudes of the various errors, and selecting a viable approach for meeting the desired performance goals. After the EB procedure, a system error model is obtained by conducting a series of experiments through which a relationship is established between individual process parameters and the quality of the workpiece. Once the system error model has been validated, a reliable assessment can be made of the impact of reducing, eliminating, or applying a suitable compensation technique to the different error components.

Process parameter information can be used to monitor the condition of a manufacturing operation as well as provide a process control signal to a feedback algorithm. If any of the key process parameter deviates, an error is known to have occurred. The error can come from two sources: machine accuracy related and tooling accuracy related. Machine accuracy can be described in a generic term that is how accurate the tool path can be. In general, this characteristic is influenced by two categories of error: quasi-static error and dynamic error. Quasi-static errors are process disturbances that change relatively slowly and have long time constants. The result of this type of system error is usually observed as the degradation of part form due to the inaccurate positioning of the tool with respect to the workpiece. Quasi-static errors are related to machine structure and design (the geometry and kinematics of the machine) and normally caused by slowly varying forces that act on the machine and thermally induced strains in the machine tool. Dynamic errors are related to a machine's servo system, such as vibration, spindle errors, axes motion errors, etc. This type of error occurs in relatively high frequency and in short time constants. It is associated

with the travel of a machine's moving elements and can be discussed in relation to typical machine axes (Figure 2). With the type of linear carriage shown in Figure 2, it is possible to measure six individual error elements due to the six degrees of freedom. The result of this type of error can be observed in many forms, such as the dimensional or geometric errors on the workpiece. These errors are normally the combination of these six error elements.

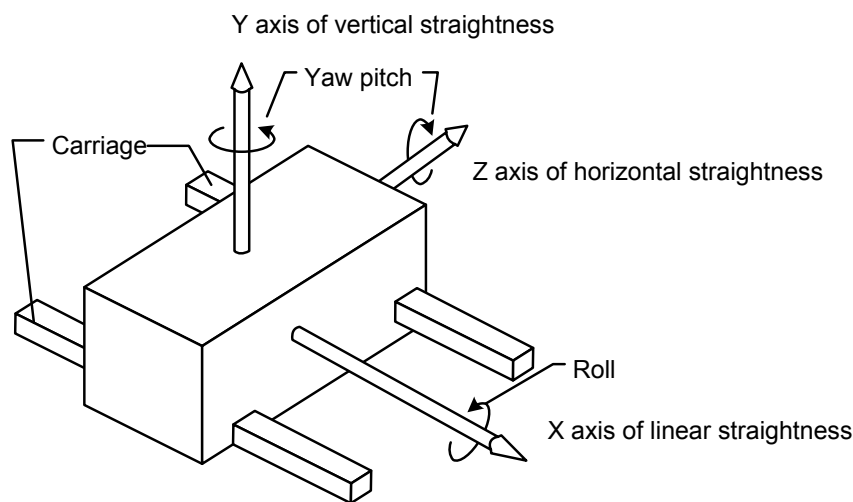

**Figure 2: Six error elements in linear axis motions**

Tooling accuracy related errors can also be categorized in two groups: workpiece fixturing and cutting tool errors. Workpiece fixturing error is mostly caused by wrong clamping force, which makes the workpiece deform. Cutting tool errors are mostly caused by misalignment between cutter and machine axis and errors in the shape of the cutting tool. For example, the misalignment between cutter and machine axis causes the “high point” of the cutter is wrongly projected in tool path. The errors in the cutting tool shape result in the workpiece is machined without maintaining a constant contact point between the workpiece and the cutter.

Once a correct manufacturing system error model is established, key process parameters can be identified. Constant monitoring of these key parameters and their error occurrences enables correct compensation or adjustments to the control of manufacturing processes. Therefore, a stable and accurate manufacturing system is achievable. For example, if errors due to component deflection, machine geometry, etc. are relatively constant, then tool

offsets based on the condition of the cutting tool can improve the system performance. However, if adjustments are made based on historical data rather than immediate monitoring, then the system is vulnerable to unexpected changes in factors such as tool performance, material characteristics, operator induced changes in feeds and speeds. Offsets that are based on product certification results are a little better, since there is a closer tie with the “current process”, but the delay between production and inspection can still cause difficulties. In-process measurements offer the best alternative as long as the time required to collect data is not an unacceptable cost to production operations. In order to be useful, in-process measurement data must be easily obtained; the prediction of system performance must be accurate and useful to the process operator.

Apart from improving the accuracy and consistency of manufacturing operations, in-process measurements of critical parameters can be used to provide real-time assurance that the workpiece quality is being maintained at the desired level. This usage of in-process measurement with OMM is the primary focus of this research. Aside from the obvious step of measuring one or more critical dimensions on a finished workpiece, additional process data can be collected to qualify the process before the part is removed from the machine tool. The data collected through in-process measurement can also be used to analyze the process consistency, the deflection/size errors, and tool wear errors. Therefore, compared with the other two types of CLM measurements mentioned above, in-process measurement has the advantages of providing direct, continuous, real-time measurements of those part attributes that are defined in the acceptance-tolerance criteria for the workpiece.

### **1.3. In-process Measurement**

Inspection, including dimensional inspection, has commonly been an activity performed after, rather than during, a manufacturing step or process. In many instances, several steps may have been performed before a part is measured. If the part is found to deviate from the specified tolerances, it must either be rejected at a point where considerable value has been added or be reworked. In either case, the manufactured cost has been boosted. As aforementioned, in-process measurement is significant in that it ultimately allows a manufacturer to achieve a goal of zero scrap (i.e. the “first part correct” paradigm), since deviations in the manufacturing process measured by sensors can be used in a corrective

manner to control the process before tolerances are exceeded. Advances in sensor technology and digital computers and controllers are permitting a dramatic increase in the application of in-process measurement and control.

The concept of in-process measurement and control has to do with (a) measuring a process variable while that variable can still be influenced and (b) applying a corrective feedback to the machine that affects the process so as to encompass those sources of error that normally occur during the process and thus eliminate error from the variable on the resultant workpiece. Figure 3 illustrates the basic concept of in-process measurement.

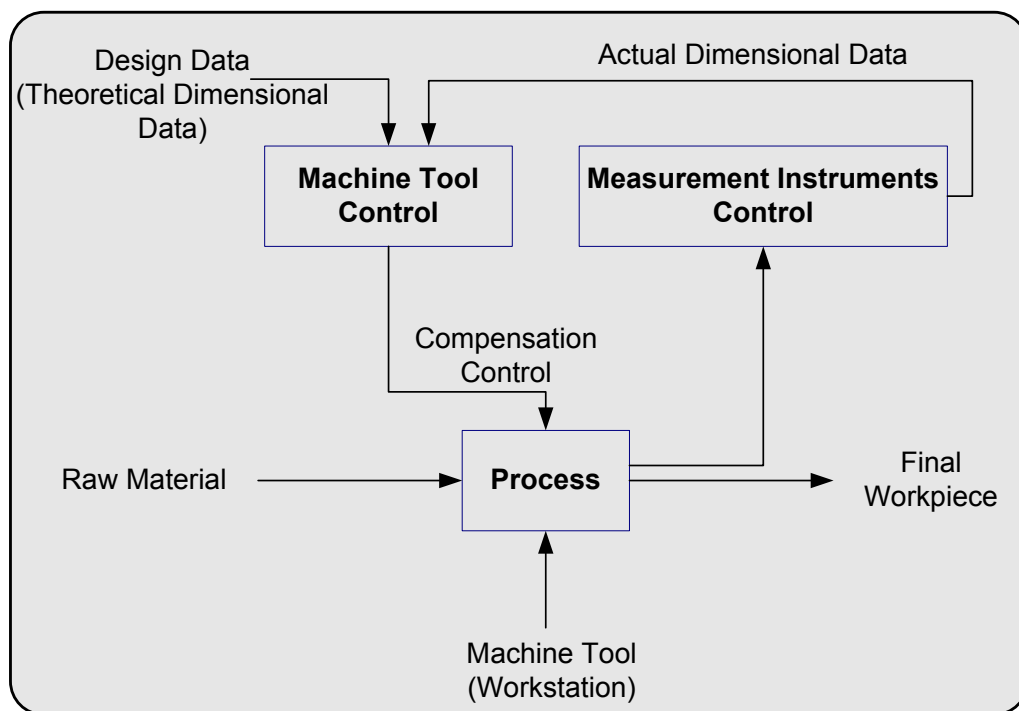

**Figure 3: Concept of in-process measurement**

In order to produce a workpiece, raw material is required, equipment such as a machine tool is needed to effect the process, and something to describe quantitatively the amount of material to be removed – the design drawing or data from the design – is required. During machining process, OMM instruments or portable measurement instruments provide a continuous measurement that can be in the form of an analog signal or a digital data work, which is compared with the required dimension derived from the part design. The result of the comparison is a compensatory signal which is applied to the machine control so as to

restore the dimension within its allowable range on either the part being machined or subsequent parts.

The use of limited in-process measurement coupled with the monitoring of the key process parameters of manufacturing process as a substitute for extensive postprocess inspection is becoming more realistic and attractive in achieving fully automated manufacturing process [9]. The two types of measuring devices commonly used in in-process measurement (introduced in Section 1.1) are OMM and portable measuring devices. Compared with portable measuring devices, OMM has been gradually used as the preferred measuring equipment for the purpose of direct inspections in manufacturing and quality control, which is a vital feature for an automated production system. In-process measurement with OMM operations is a process that integrates the design, machining, and inspection aspects of manufacturing to allow a product to be inspected and accepted directly on a machine tool. This process is accomplished by using the machine tool as the inspection device while the part is secured on the machining centre with its coordinate system intact. Using the machine tool as an inspection device eliminates the need for expensive inspection equipment, allowing the manufacturer to divert resources to other uses. There is no need for inspection fixture either, because the machine tool part fixture serves as the inspection fixture. As the workpiece gets more complicated, the role of OMM becomes more significant as efficient dimensional measuring equipment [12]. Sensors present in a CNC system have the capability of providing accurate feedback for the different drive/motors. They are often limited to just perform these functionalities and not geared toward supporting those inspection tasks which are effectively what OMM is about. The advantages of employing OMM for in-process measurement are summarized as follows [13-17].

- 1) Cost and time saving through
  - (i) reducing lead-time required for gages and fixtures,
  - (ii) minimizing need for design, fabrication, maintenance of hard gages, fixtures & equipment,
  - (iii) reducing inspection queue time and inspection time, and
  - (iv) eliminating rework of nonconforming product.

- 2) Changing from “reactive” inspection to “proactive” control by
  - (i) integrating quality control into product realization process,
  - (ii) using characterized and qualified processes to increase product reliability,
  - (iii) focusing resources on prevention of defects instead of detection in the end (a post-mortem process),
  - (iv) utilizing real-time process knowledge and control, and part acceptance/disposition, and
  - (v) enhancing small lot acceptance capability.
- 3) Elimination of non-value added operations such as lot inspection, sampling plans, receiving inspection, design, fabrication and maintenance of hard gages, and reworking nonconforming parts;
- 4) Agile machining.

OMM enables quick responses to product design changes. Since inspection operations are carried out on the same machining centre, inspection gages and fixture changes are not required. New and existing technologies such as probing strategy, error compensation, data analysis software and fixture design technology can be integrated into the OMM system. As errors occurring during machining processes are detected and recorded as they appear, part distortion can be “corrected” promptly by adjusting the subsequent machining operations.

Therefore, in-process measurement with OMM operations presents a promising solution toward improving manufacturing processes; it is the main focus of this research. A question might be raised as to the validity of dimensional measurement on the same machine that makes the part. While measurements performed by a cutting machine are subject to some of the same error producing factors as the cutting progress, the errors that are most difficult to eliminate through machine maintenance and certification can easily be detected and accounted for with in-process measurement. For example, machine flexing, tool wear, and vibration will all be absent during measurement. Additional error compensation techniques such as laser measurement, ball-screw compensation, and measuring pre-cut proofing parts for future reference can also be applied to compensate for



other machine inaccuracies. The ability to rectify manufacturing errors caused by problems such as these has led to the acceptance of in-process measurement as part of a manufacturing system [18]. Apart from the concern of OMM accuracy, a traditional objection to OMM is that it diverts machine time away from actual machining. This notion can be overcome by measuring productivity in terms of total in-process time rather than machining cycle time. The view that OMM steals machining time overlooks the fact that checking a part off-line, a step that OMM seeks to replace, can impose the need for additional part handling and another setup; this adds to in-process time, as well as introducing the potential of fixture errors [13].

### 1.4. Measurement Sensors

Although the advantages of in-process measurement are obvious, it is not a trivial task to accomplish in manufacturing processes. The main reason for this is attributed to assorted physical constraints such as the presence of chips or coolant which obscure a location that needs to be inspected. Therefore, selecting proper measurement sensors is essential. Sensors in manufacturing are usually involved in three generic types of monitoring applications [19]. They are for

- 1) production monitoring where transducers are utilized to determine the status of operations on the production floor,
- 2) machine monitoring that involves determination of whether or not a process is functioning properly (an early warning of the need for preventive maintenance or process adjustments is the objective of these measurements), and
- 3) environmental monitoring where sensors provide information concerning the condition of an area. A common location for the installation of these sensors is in the heating, ventilation and air conditioning system.

As might be expected, each of these broad categories overlaps with the others to a certain extent. The sensors used for in-process measurement belong to the second category – machine monitoring sensors. These sensors can be categorized into numerous different types. The most commonly used sensors in the industrial manufacturing environment are for measuring force, power, and acoustic emission, such as touch trigger probes and dial

gages. Different types of sensors can achieve different levels of accuracy. Figure 4 summarizes the level of precision that each types of sensor can achieve, and the parameters these sensors are used to control.

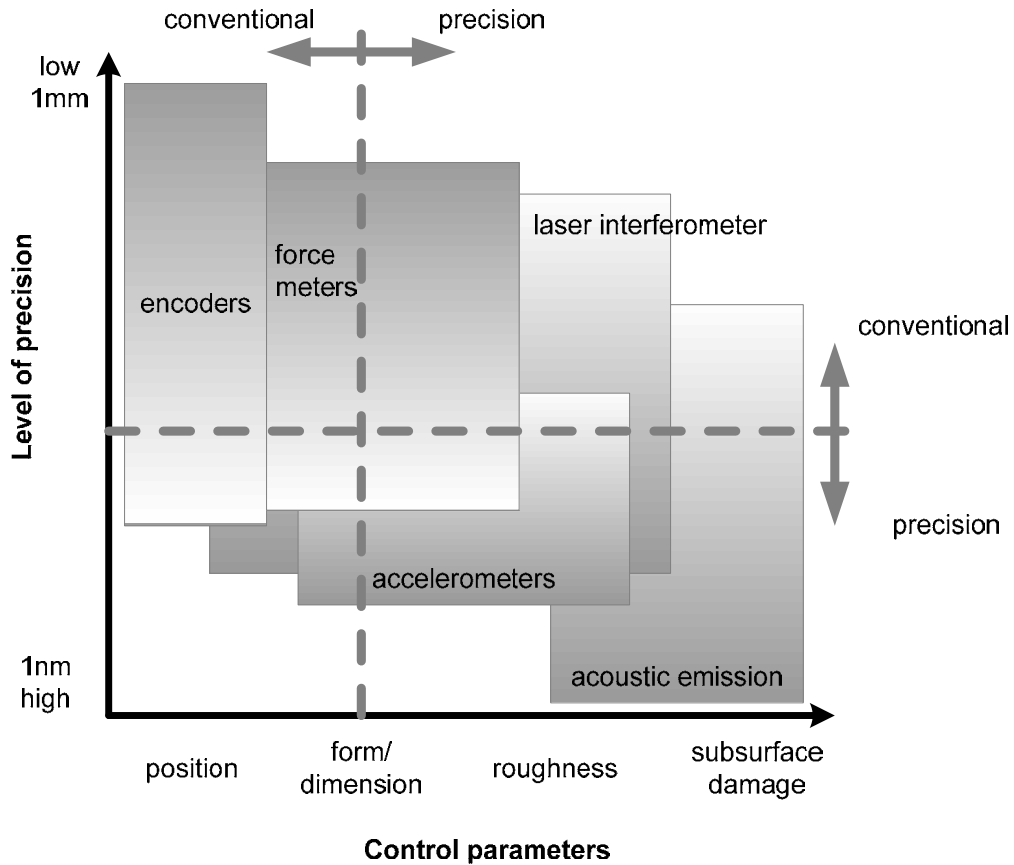

Figure 4: Sensor application versus level of precision and error control parameters [19]

Since in-process measurement on workpiece acceptance (form and dimension) with OMM operations is the primary focus of this research, force meter sensors are more suitable than other types of sensors. Considering the real-time manufacturing environment, the chosen force meter sensors should be able to resist the moisture environment (caused by coolant) and sharp edges (generated by chips). Touch trigger probe, as such a sensor, is chosen for this research to conduct measurements.

## 1.5. Information and Data Model for In-process Measurement

The advantages of using in-process measurement with OMM operations to monitor machining process and workpiece dimensions in real-time are discussed in the above sections. However, where and when to carry out OMM operation still remains a problem. In order to have optimal OMM operations for in-process measurement, sufficient product related information together with a knowledge base is needed for carrying out process planning. This information includes

- design information or product definition information, such as design features and tolerance requirements,
- machine accuracy information from a machine tool database or knowledge accumulated at shop-floor,
- process planning information, such as machining operation sequence, and
- measurement device related information, such as sensor dimension and data collection type.

Only when all this information is provided for the process planning system can an efficient and optimal in-process measurement process be planned for a chosen machine environment or a machining process. In industry, many commercialised software tools are used for different manufacturing activities. For example, Pro/E and CATIA are the software for designing a product, MasterCAM and SolidCAM are for machining process planning, Metrolog and PC DMIS are for inspection process planning. Each of these software tools has its own proprietary data format. A complete in-process measurement process planning system often needs data from the design and process planning stage, and the data is input to inspection process planning software to generate a proper in-process measurement plan. The proprietary data format hinders smooth information exchange between these software tools or process planning systems. Tedious interpretation between different data format is time-consuming and expensive. With a more decentralised manufacturing industry, the desire for a consolidated data model that can be exchanged freely between different manufacturing activities is inevitable. This kind of data model will also enable the integration of in-process measurement with machining process planning, thus making in-process measurement process planning more efficient and accurate.

### 1.6. Recap

Recognizing the deterministic nature of manufacturing operations paves the road for improvements in product quality and reduction of production costs. This is accomplished by measuring the important process parameters and by performing appropriate adjustments in the system commands; through this a CLM system is formed. The elements necessary to form an efficient CLM system are an operational strategy or model that establishes acceptable limits of variability and the appropriate response when these conditions are exceeded, a means of measuring change within the process, plus a mechanism for inputting the necessary corrective response. Three types of measurements exist in CLM systems serving three types of closed-loop in the manufacturing systems. Compared with in situ measurement and remote measurement, in-process measurement, commonly used for process control loop, has the benefits of being able to monitor manufacturing process in real time when a significant alteration has occurred within a manufacturing cycle. In-process measurement can be used in two ways: process control (monitor key process parameters) and process qualification (monitor workpiece form/dimension acceptance). The data collected in both practices can be used in statistical analysis to improve manufacturing processes.

To facilitate process planning for in-process measurement with OMM operations and to utilize the measurement data more efficiently, the input data must provide explicit and complete representation of product data such as workpiece features and tolerance requirements. Only based on this substantial product design information can the machining and inspection features be identified, and associated machining and measurement operations be sequenced in an optimal order. Therefore, a consolidated data model including product definition information, machining process planning information, machine tool and measurement sensor information is a necessity.

### 1.7. Thesis Organization

This research focuses on developing an automated in-process measurement system with OMM operations to monitor workpiece geometric and dimensional characteristics during machining processes. Measurement data is analysed right after inspection and update value

is fed back to the following machining operation for necessary corrections. Among all types of measuring sensors, touch trigger probe is chosen for the measurement operations.

Chapter 2 gives a thorough review of Computer-aided Inspection Process Planning (CAIPP) from the mid 1980s to recent years. It identifies the research trends in CAIPP research and function modules which a complete CAIPP system should consist of. The review reveals problems in the current CAIPP systems. Following the review is an investigation of dimensional metrology interoperability issues, which stems from the same reason that leads to the problems in CAIPP systems.

Chapter 3 gives a detailed account of new ISO (International Organization for Standardization) standards ISO 10303 (STEP) [20] and ISO 14649 (STEP-NC) [21] standards. It starts with an overview, history, and objectives of STEP. This is followed by a description of various Parts and the technical content of STEP and STEP-NC.

In Chapter 4, a review of research on STEP/STEP-NC related CAIPP and STEP/STEP-NC standard development is discussed. Then, the proposed STEP Application Protocol ARM data model for integrated CNC machining and inspection is described in detail.

In Chapter 5, the framework of the proposed integrated process planning system is presented. It consists of three main sub-systems: a macro process planning system that identifies critical GD&T requirements, selects measurement geometry, and inserts new in-process measurement operations in-between machining operations; a micro process planning system that generates measurement points for each measurement operation; a measurement result analysis and feedback update system that provides real-time feedback to the subsequent machining operations based on measurement result analysis.

Chapter 6 describes the implementation of the proposed system. A STEP-INSPEC software prototype was developed. The algorithms developed and implemented in the software prototype are discussed in detail. This is followed by the introduction of the case studies that are used to test the proposed STEP Application Protocol ARM data model for integrated CNC machining and inspection and the STEP-INSPEC software.

Chapter 7 gives an in-depth discussion of the proposed data model and the integrated process planning system summarizing their advantages and benefits. Then, conclusions are drawn for the research. This chapter ends with suggestions for future research directions and recommendations.

There are two Appendices at the end of the thesis. Appendix A contains EXPRESS-G diagram of proposed data model. Appendix B includes the STEP Part 21 files of the two case studies carried out in this research. Appendix C includes three output files generated from the STEP-INSPEC software prototype for the second case study. These files are the Canonical Machining Command (CMC) output, G-code output, and the new STEP Part 21 file. Appendix D includes the abstracts of 6 journal papers and 2 conference papers that the author has published/accepted.

## *Chapter 2 Literature Review*

Inspection process planning is an integral part of design and manufacturing activities. It determines what characteristics of a product are to be inspected, where and when. As introduced in the previous chapter, in-process measurement is the focus of this research. It gives manufacturers the opportunity of controlling production and achieving the desired quality during manufacturing processes rather than being a means of acceptance or rejection at the end. To have efficient in-process measurement operations, fast yet accurate inspection as well as effective integration with the product model and relevant databases is required. With the fast growth of product complexity and variety and the constant demand of reducing product development cycle, industries are in search of more automated inspection process planning for measurement operations and better decision support tools.

In manufacturing processes, decisions made in the course of process planning have a significant effect on the resulting product quality, in addition to the production time and cost. Some manufacturing methods and sequences selected during process planning may be more prone to errors and inconsistencies due to a large number of setups or an improper choice of datum and references. Coupling manufacturing process planning with inspection process planning leads to closure of the desired quality assurance loop and, when taken in the wider context of concurrent engineering, will ensure that quality is “designed-in” from the start, and reduce costly rejected and/or reworked parts [22].

In a conventional quality control system, a workpiece machined on a machining centre requires being moved to a CMM to check its dimensional accuracy. The manual job set-up and inspection of machined parts are usually time consuming, subject to human errors, and often lead to longer lead times and the need to rework. The bottleneck problem is further compounded with the difficulty of capital investment and time delay of material flow between CMMs and machine tools in the factory.

Inspection process planning for CMMs has been a research focus for more than twenty five years. With increased accuracy and stability of CNC machine tools and more capable measuring devices, OMM has become widely accepted in industry. However, the inspection process planning for OMM operations are still lack of research attention. This chapter first reviews the CAIPP research for CMM, followed by the review of CAIPP for OMM operations. Then, the fundamental reason why CAIPP for OMM demands research – issues in dimensional metrology interoperability and standardization – is discussed.

The major part of this chapter has been reported in one published journal paper [2] and one journal paper *in-press* [5].

## 2.1. Review on CAIPP Systems

A CAIPP system may include automated or semi-automated modules capable of identifying and recognizing dimensional inspection features along with associated inspection constraints. It should be able to recommend an inspection method for each dimensional inspection feature. The resulting inspection operation also needs to be integrated into an overall inspection plan [23].

Automatic inspection planning for dimensional and geometric inspections can be at a high level or a low level. High-level (macro) planning is concerned with producing a collection of setups. Each set-up is related to accessibility of the features to be inspected, the probes to inspect each type of feature and the relative orientation of the part. Attempts are made to group the features, the types of tolerances and the type and size of probes to be used. Low-level (micro) planning primarily addresses the issues of point selection, path generation, and generation of executable codes. Although much of the inspection carried out in industry continues to be conducted using conventional metrological equipment, most of the recent CAIPP systems are based on CMMs.

Research on CAIPP systems started in the early 1980s. Before the mid-1990s, most of the research work remained at the conceptual level (macro level) CAIPP systems [2]. These systems can be categorized into two groups:



- 1) tolerance-driven inspection process planning system, and
- 2) geometry-based inspection process planning system.

The research in the first category focused on planning inspections for those features that have specific tolerance requirements. The research in the second category focused on planning the inspection process to obtain a complete geometric description of a manufactured workpiece using the inspection data. Thus, comparison can be made with the design model for a complete geometry inspection.

From the middle of the 1990s, research on CAIPP systems started to shift to one or some of the modules that a typical CAIPP system has (the micro-level), such as sampling strategies and probing path planning strategies. At the same time, non-CMM measurement, such as 3D optical scanner, attracted more and more attention. Therefore, CAIPP system research for non-CMM measurement methods has become another major characteristic of the research trend during this period. The following sub-sections first review the research prior to 1995 in the two aforementioned categories respectively, followed by reviews on recent CAIPP research according to the modules that each research focused on.

### **2.1.1. Early Research (Prior to 1995) on CAIPP**

Early research (prior to 1995) on CAIPP systems is reviewed in this section briefly. Only 2½D manufacturing features are considered. Free-form surface inspection is quite a different research area and is not the concern of this research. Interested readers are referred to a review by Li and Gu [24].

#### ***2.1.1.1. Tolerance-driven CAIPP Systems***

One of the earliest CAIPP systems was developed by EIMaraghy and Gu [25]. It used a knowledge-based approach to generate inspection tasks. The system was developed in PROLOG and used a feature-oriented modelling approach. It took into account the characteristics of the CMMs, the function and geometry of the inspected part as well as the geometric and dimensioning standards and theories. It was the first system to group inspection features according to their datum, assign inspection priority based on the nature and magnitude of the assigned tolerance and check features accessibility in a given part

orientation. Figure 5 shows the planning logic which resulted in a recommended inspection feature sequence, probe selection and part orientation sequence. The system has a modular structure and features serve a key role.

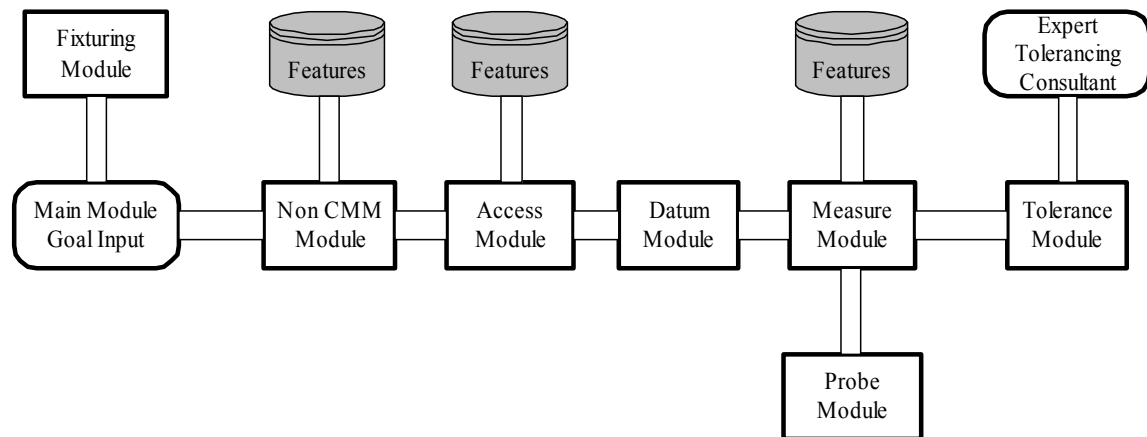
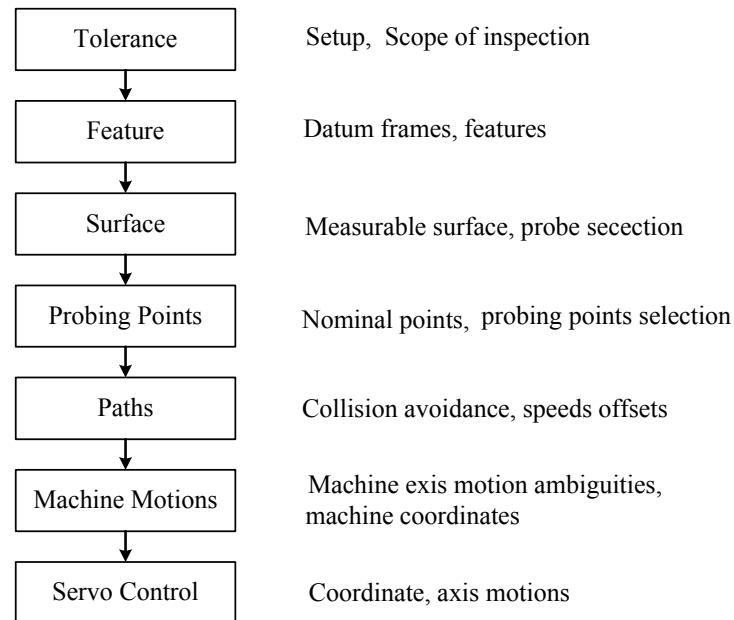

**Figure 5: An expert inspection planning system model [25]**

Helmy, H. A. [26] developed a feature recognition module that extracts the data of a component from its B-Rep geometric model, and then uses the data to generate a Dimensional Measuring Interface Standard (DMIS) [27] inspection program. Attributed Adjacency Graph (AAG) was used to group the inspection features. AAGs were introduced by Joshi and Chang [28] to enable machined feature recognition for machining process planning. The recognition approach includes procedures for each different manufacturing feature such as steps, slots and cylindrical holes. Using these recognition procedures, together with the AAG representation and a wireframe visualization interface, the features of a component to be inspected are selected interactively. The implementation of the system requires the user to enter the machine coordinated system, the number of measurement points required, and the tolerances to be measured.

Hopp and Lau K. C. [29] presented an approach using an inspection control hierarchy to generate control codes for CMMs (Figure 6). After the user selects the required tolerance from a Computer-aided Design (CAD) database, the scope of the inspection is determined and the characteristics of the tolerance are identified. The surfaces involved in the characteristics are then selected for inspection and probing. Next, probing points, path planning, machine motion, and servo commands are carried out sequentially. A CMM

inspection program is then generated. Some commercial systems such as Valisys [30] and Audimess [31] use a similar approach.



**Figure 6: An inspection control hierarchy**

Medland and Mullineux [32-34] tried to integrate a CMM with a manufacturing system. The inspection plan is created automatically from a feature-based model, which contains information about the features, their significance (i.e. importance of their dimensional accuracy for the acceptance of the part), the requirements on different probe types and orientations to reach the feature. The developed system is modular and based on a manufacturing network where communication is achieved through files exchanged within an integrated manufacturing environment. The measuring activities are controlled by a combination of dedicated programs and a constraint modelling system.

The system developed by Merat *et al.* [35] is part of a large effort to develop a Rapid Design System (RDS). The objective is to reduce the time from design to manufacture and inspection. In this system, tolerances are represented as features. An overall inspection plan consists of fragments, each of which relates to how toleranced geometry of a given feature is to be inspected. These Inspection Plan Fragments (IPF) are generated based upon rules and methods used in industrial practices. Inspection planning is the selection of appropriate IPFs which result in an overall time efficient plan. IPF is generated by a macro

called the IPF Generator. For each tolerance it generates a corresponding IPF with a suitable CMM probe, probing orientations and any required inspection tools other than CMMs such as depth micrometers. Feature accessibility analysis is not included and the inspection steps for various features are not prioritized or clustered to generate an optimal sequence.

The CAIPP system developed by Yau and Menq [36-38] consists of five modules: (1) inspection specification, (2) automatic inspection planning, (3) CMM verification, (4) CMM execution, (5) comparative analysis. The core of the system is a knowledge-based inspection planner that monitors process flow and assists decision-making. The main function of the inspection specification module is to translate functional requirements, tolerances, manufacturing parameters and CMM constraints into inspection specifications. The results of the specification module are used by the planning module to generate the probe path. The manufacturing accuracy and tolerance specification are taken into consideration. The generated path is then verified to ensure a collision-free path. The execution module carries out the inspection and generates the data. The measurement data together with the design model and inspection attributes are processed by the comparative analysis module to generate an inspection report.

Tannock *et al.* [39] developed a measurement planning system. They classified their measurement workpiece via a feature-based approach, and established measurement planning data through inquiries.

Brown and Gyrogo [40] discussed a prototype system named IPPEX (Inspection Process Planning EXpert system) for the development of a generative process planning expert system for dimensional inspections. IPPEX uses a product geometric modeller coupled with a dimensional and tolerance modeller to generate inspection instructions in the form of an operation plan and as a part program in compliance with the DMIS standard.

All the above reviewed research works focused on developing conceptual level CAIPP systems for CMMs. Most of these CAIPP systems need inspection operator's input for either selecting inspection features, or tolerances that need to be inspected. This type of research has laid a good foundation for the later-stage CAIPP research.

### 2.1.1.2. Geometry-based CAIPP Systems

Unlike a tolerance-driven CAIPP system, geometry-based CAIPP systems largely ignore tolerance information, but focus on geometry-matching between a machined part and its designed shape. Duffie *et al.* [41] developed a technique to obtain a measured database for a machined part and then compared it with a CAD database. Inspection features were defined by operators. The inspection of part surfaces is carried out automatically using a tactile sensor. This inspection process results in the collection of a database of measured coordinates on the part surface. This measured database is compared with a CAD database defining the desired part geometry, then results in a determination of the error between the actual measured part and the desired part geometry at each measured point.

Menq *et al.* [42] developed an optimal match scheme that aligns measurement data with design data during the CAD-directed dimensional inspection. Cho and Kim [43] developed a flexible three-dimensional inspection system for sculptured surfaces by employing CMM, CAD database and vision system technology. The proposed system (shown in Figure 7) performed optimum inspection planning, recognition of the workpiece, and compensation for alignment errors. The recognition/localization database was generated from the CAD database based on a new concept called Z-layer. Then, a 3D shape of the object on the table of the CMM was constructed by using a vision guided CMM.

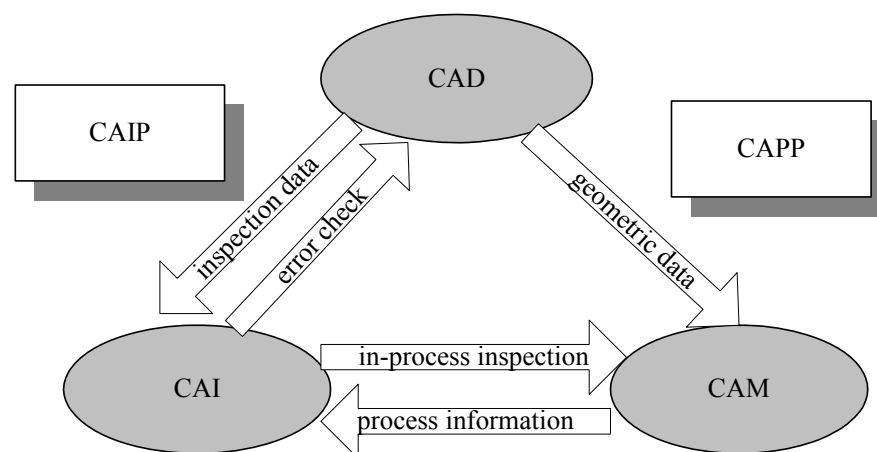

**Figure 7: The role of CAIP and the inter-relations between CAD/CAI/CAM**

Corrigall and Bell [44, 45] at Loughborough University of Technology, UK developed a system for code generation for CMMs using geometric data and relationship information of the component defined in a product model. Datum setting operations, measuring and probe orientations, probing points and safe rapid paths are automatically determined, and part programs for a CMM are also generated. This system inspects 100% of the geometry of a component with the exception of those geometric elements which lie beyond the capacity of CMM.

The Design to Inspection project led by Sira [46] aimed to develop methods that would support the design process, ensuring that designs could be manufactured and inspected consistently and sufficiently. Prototype software, known as CAVES (Computer Aided Validation Expert System), was developed to validate designs. The project identified the limitation of current geometric modellers and concluded that a powerful product modelling system is required if product validation is to be achieved in an automated fashion.

Geometry-based CAIPP systems have not received as much attention as tolerance-driven CAIPP systems. In comparison with a tolerance-driven CAIP system, a geometry-based system tries to measure the entire part; a process that is time consuming.

### **2.1.2. Recent CAIPP Research for OMM and CMM**

From the CAIPP research reviewed above, it is found that a complete CAIPP systems must have modules for the following tasks:

- 1) inspection feature selection and sequencing;
- 2) measurement/sampling points selection and optimization;
- 3) collision-free probing path planning and generation (including probe accessibility and orientation);
- 4) inspection execution.

From the mid 1990s, CAIPP research shifted its focus to one or some of the above modules. Also, as new measuring devices and measuring technologies, such as non-contacting measuring devices, became mature and available for CAIPP systems, inspection process planning for using different types of measuring devices became another research

trend. Some of these new measuring devices include laser scanning devices, optical measuring sensors, pneumatic measuring devices, etc. Compared with traditional gages and touch probes, non-contact probes are able to provide large amounts of data in a relatively short time with higher accuracy. Therefore, the inspection process planning strategies for these new measuring devices are different from those for traditional touch tactile sensors.

Bogue [47] discussed the limitations of contact-probe-based CMMs scanning and described a new, laser-based 3D geometrical scanning system developed jointly by Metris and Volvo for assembling purposes. Vezzetti [48] presented a selective sampling acquisition approach for boundary definition in reverse engineering. The proposed approach is developed for optical scanning devices. Umberto and Cavalli [49] proposed an optical measuring probing system, which can be used to perform on-line measurement. However, these optical equipments also have stringent requirements with respect to the measuring environment. For example, mist, unclean workpiece surfaces, reflective surfaces, and temperature lead to measurement errors. Auilar, *et al.* [50] analyzed the accuracy and error mechanisms of laser scanning probes using simulations and experiments. Several tests have been carried out with a laser scanning probe mounted on a CMM to determine the main error sources. The research on CAIPP for optical measurement devices is still limited.

In the following section, the relevant CAIPP research works for CMMs are reviewed in the order of the above modules.

### ***2.1.2.1. Inspection Feature Selection and Sequencing***

Inspection features are rooted in dimensions and tolerances that have a significant influence upon the functionality of the component. Determination of these inspection features used to rely upon the skill and experience of inspection engineers. Most of the research works reviewed in section 2.1.1 (the early research) either required the user to specify each and every face that is necessary to be probed for inspection, or automatically select machining features that are previously recorded/controlled for inspection. Therefore, the degree of automation was severely limited. Recently, the research focus was to develop

CAIPP systems that can recognize/extract inspection features directly from a CAD model and sequence them automatically. When a workpiece is measured on a CMM, most of the machining operations have finished already before measurement. The functionality of inspection is merely an acceptance check. The inspection features selection and sequencing for this type of inspection processes are more related to the probe accessibility and probe orientation. Therefore, inspection feature grouping/cluster is the main focus of most related CAIPP research.

Zhang *et al.* [51] proposed a feature-based inspection process planning system for CMMs. The proposed system is a prototype designed to produce an inspection process planning directly from a CAD model. The inspection process planning prototype system includes five functional modules (Figure 8): tolerance feature analysis, accessibility analysis, clustering analysis, path generation and inspection process simulation. The tolerance feature analysis module is used to parse tolerance information and establish relationships between tolerance information and surface feature. The accessibility analysis module evaluates all accessible probe relationships between tolerance information and surface feature. The clustering analysis module groups inspection probe and surface features into inspection groups so that time for inspection probe exchange and calibration can be reduced to a minimum. The path generation module determines the number of measurement points, their distribution and their inspection sequences. The inspection process simulation module provides an animated display of the inspection probe path and checks whether a collision occurs between the part and the inspection probe.



**Figure 8: Flowchart of the feature-based inspection process planning system**

Vafaeseefat and ElMaraghy [52] proposed a methodology to automatically define the accessibility domain of measurement features and group them into a set of clusters. The methodology uses the CAD model of the workpiece and tolerance information as input to an algorithm for defining feature accessibility. The CAD model is first converted to the STereo Lithography (STL) or Virtual Reality Model Language (VRML) format for Probe



Orientation Module (POM). The user chooses probes and measurement features, defines coordinate systems, specifies tolerances and datum for measurement points. Then, probe paths are generated automatically.

Limaiem and ElMaraghy [53] proposed a Computer-Aided Tactile Inspection Planning (CATIP) system. Inspection features are selected based on a CAD model and the tolerance requirements. These inspection features are the input of the system, which contains four modules (Figure 9). Inspection features are sequenced based on their accessibility and minimization of probe orientation.

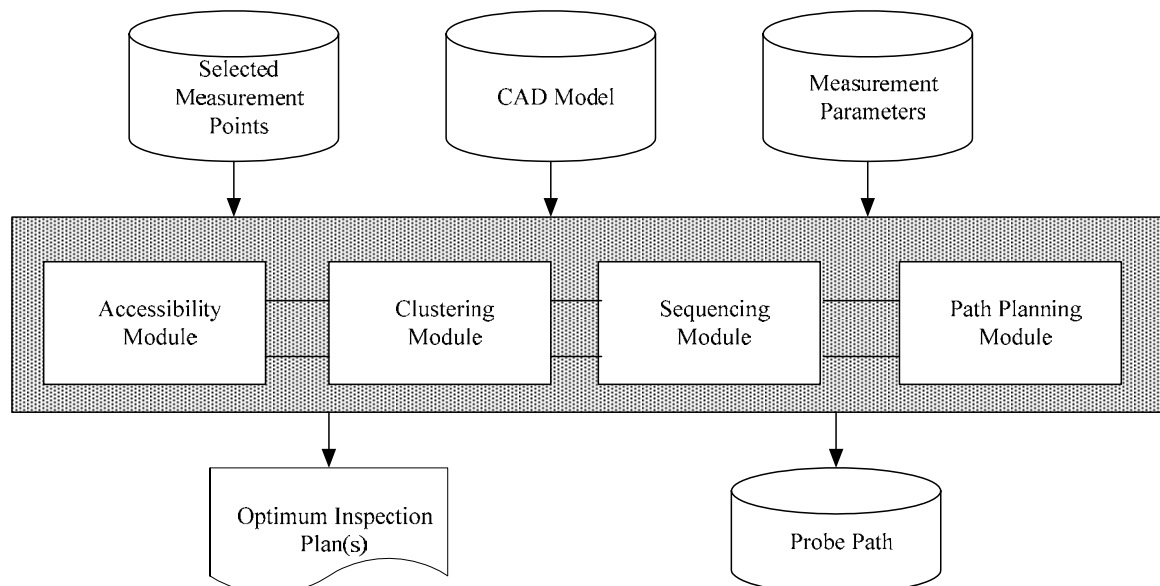

**Figure 9: CATIP system structure [53]**

Hwang, *et al.* [54] proposed a CMM inspection planning system for the purpose of minimizing the number of part setups and probe orientations. Inspection features are selected based on the tolerance specifications by the users. After receiving the inspection feature information, the proposed system firstly analyzes the accessibility of each feature. Then, the feature accessible information is used to derive the required part setup and probe orientation. Based on a proposed decision rule that aims to minimize the number of changes of part setup and probe orientation, the sequence of inspection features were decided.

From the above review, it can be concluded that probe accessibility and probing orientations are the major considerations for CMM-based inspection feature grouping and sequencing. The CAIPP systems for CMMs, apart from the different focuses of each research, mostly analyze the accessibility of each inspection feature and the necessary probe orientation changes in order to decide the sequence of inspections. The effort is to minimize the change of probe orientations which contribute to the bulk of CMM inspection time.

#### ***2.1.2.2. Measurement/Sampling Points Selection and Optimization***

The inspection processes carried out on CMMs often use touch-type probes to perform point-to-point motions when recording 3-D coordinates of a workpiece. The more measurement points (or sampling points) that are chosen, the more reliable are the results. However, since the increase of the number of measurement points usually leads to the increase in measuring time, the appropriate number of measurement points has to be determined for each feature and tolerance to be measured. This section reviews related research on touch-type probes. Since scanning probe collects measurement points by dragging along the measurement surface, a large amount of data can be collected in a relatively short time. The measurement points allocation and probing path planning for scanning probes is distinctively different from that required for touch-type probes. Limited research was carried out in this area.

Elkott *et al.* [55] reviewed research works on sampling strategies for CMM inspection. Based on this review, the authors summarized the literature review of sampling for inspection planning (Table 2). The brief review of the research works in the table is represented in the following paragraphs. Some useful methods have been proposed to decide proper measurement points for each inspection feature by considering tolerance levels, geometric characteristics, and desired confidence levels.

**Table 2: Summary of research on measurement points sampling**

|                          | Prismatic and conical surfaces  | Free form surfaces  |
|--------------------------|---|---|
| Sampling optimization    | Woo and Liang 1993 [56]<br>Zhang et al. 1996 [57]<br>Cho, Lee et al. 2004-2005 [58]<br>[14]<br>Jiang and Chiu 2002 [59]   | Menq et al., 1990-1992 [42, 60]<br>Jiang and Chiu 2002 [59]<br>Elkott et al. 2002 [55]<br>Cho, Lee et al. 2004-2005 [58]<br>[14]  |
| Sample size              | Woo and Liang 1993 [56]   | Menq et al., 1990-1992 [42, 60]   |
| Alternate sampling plans | Hocken et al. 1993 [61]<br>Fan and Leu 1993 [62]<br>Lee and Mou 1996-1997[63] [64]  | Menq et al. 1990-1992 [42, 60]<br>Pahk et al. 1995 [65]<br>Elkott et al. 2002 [55]  |
| Sample location          | Woo and Liang 1993 [56]<br>Hocken et al. 1993 [61]<br>Fan and Leu 1993 [62]<br>Zhang et al. 1996 [57]<br>Lee and Mou 1996-1997 [63, 64]<br>Oray et al. 2000 [66]<br>Kim and Raman 2000 [67]<br>Fang et.al 2001 [68]<br>Cho, Lee et al. 2004-2005 [58]<br>[14] | Menq et al.1990-1992 [42, 60]<br>Pahk et al. 1995 [65]<br>Kim and Ozsoy 1999 [69]<br>Edgeworth and Wilhelm 1999 [70]<br>Elkott et al. 2002 [55]<br>Cho, Lee et al. 2004-2005 [58]<br>[14] |

Menq *et al.* [60] developed a method based on given design tolerance and machining accuracy to determine the optimum number of measurement points. Dowling, *et al.* [71] discussed the statistical issues that arise when CMMs are used. They carried out research and simulation on commonly used methods for estimating a feature's deviation range—the orthogonal least-squares and minimum-zone methods. Huang *et al.* [72] proposed a knowledge-based inspection planning system for CMMs. This system integrates part geometry information, tolerance information and heuristic knowledge of experienced inspection planners to determine the number and position of measurement points. Based on their previous research, Lee *et al.* [15] and Cho *et al.* [14] proposed a similar fuzzy system for determining the optimum number of measurement points for their proposed OMM

system. The surface area of the target surface, the grade of design tolerance and the volumetric error of the machine tool used to produce the workpiece are used as input parameters. The Hammersley's algorithm is used to locate the measurement points on the target surfaces. At the same time, the non-contact measurement point problem is handled to relocate the measurement points. Since the decomposed primitives may contain holes, slots and/or pockets where some measurement points may lie on, these measurement points should be relocated.

The algorithm developed by Huang *et al.* [72] was applied to relocate these non-contact measurement points. The effect of selecting a particular measurement sampling strategy has been recognized as a major component of measurement uncertainty [56]. This effect is due to the systematic and pseudo-random errors contained in the measurement system [73, 74].

Elkott *et al.* [55] stated that the previous research emphasized the sampling of primitive shapes, i.e. conical shapes, spheres, cylinders and planar surfaces. Researchers who worked on the sampling of free-form surfaces often adopted a uniform sampling pattern. Others who applied surface features-based methodologies developed algorithms that require large sample sizes to inspect free-form surface features. Moreover, while a few developed methodologies attempt to optimize sample size, they do not seek the optimal locations of the sample points. Most methods depend to a great extent on the skills of the users of those systems. To overcome these shortcomings, the authors proposed a sampling system that combines several sampling solutions. The system is able to automatically select a sampling algorithm that best suits the surface being inspected.

Jiang and Chiu [59] developed a statistical method for the determination of the number of measurement points for 2D rotational part features. The authors proposed a feature-based technique to determine a sufficient number of measurement points for CMMs. To use a feature-based approach in determining the number of measurement points, an acceptable error amount must be provided as the decision criterion. However, the errors caused by the measurement and the part dimension deviation from the norm are normally not separated. For form features, it is logical to use form tolerances as the acceptable error amount since it best represents the limit of the sum of all possible error sources. Regression and least-

square methods were used for checking if the number of selected measurement points satisfies the requirement.

### ***2.1.2.3. Probing Path Planning and Generation***

After measurement points are generated, the main task for probing path planning and generation module is to evaluate measurement points' accessibility, avoid collision, and optimize probing paths. Most of the research for CMM probing path generation focused on generating collision-free probing paths. It is assumed that the inspection features have already been sequenced previously for these research works.

Albuquerque *et al.* [75] used an iterative method of point placement and collision avoidance for multiple, interacting features to automatically generate probing paths (Figure 10). A list of surfaces to be measured are obtained from the overall inspection planner. For each of these surfaces an initial set of points are generated, constrained only by the desired minimum configuration and number of inspection points on each surface. The system then addresses the mapping and subdivision techniques for each set of point placement. Each set of measurements are checked for measurability after the transforming inspection point coordinates into the CMM workspace coordinates. This process is followed by iterative re-placement of points in accessible regions. After sufficient number of measurable points has been placed during the iteration process, a collision-free path is generated. This research considered many requirements such as flexible and accessible point placement, feature intersecting, and probing path optimization.

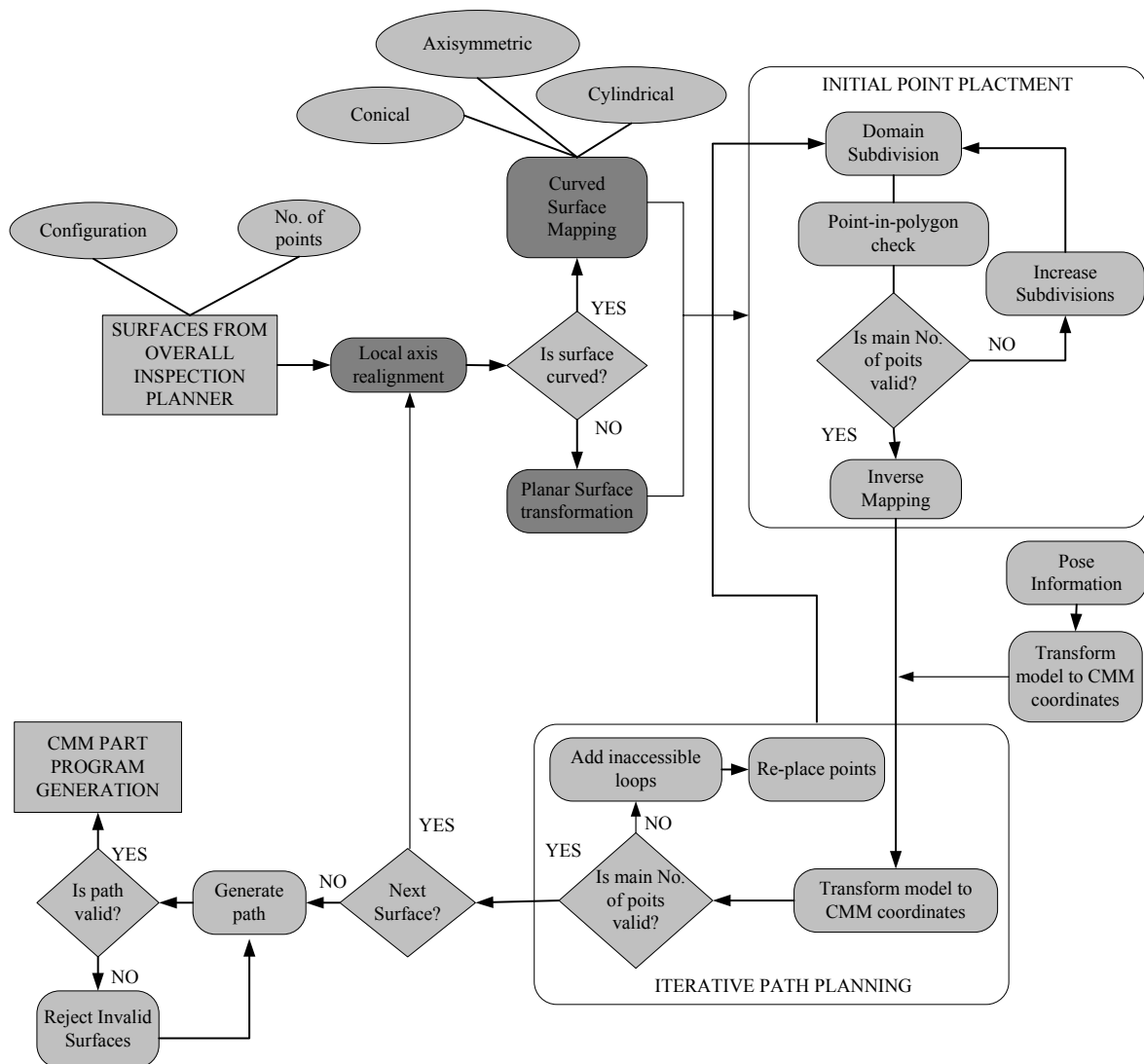

Figure 10: Flowchart of the collision free probing path generation

Ainsworth *et al.* [76] developed a probe path generation system that utilises interactions between CAD systems and users. The system has three stages, path generation, modification, and verification. The order in which measurement points are negotiated must be adapted to the geometry in question. With each inspection feature being essentially sampled over a grid of points, the measurement may be performed in unidirectional or bi-directional scans. The former is generally better suited to closed and/or highly folded surfaces, and the latter is more suited to relatively flat, open surfaces. By using a CAD model and the generated sampling points as input, the implemented path planning software initially generates a measurement path for each selected entity, based on the default parameters set by the user. The path is displayed as a set of line segments, together with

the 3D model of the part. Following this, the system allows the user to modify interactively any of the path parameters. Finally, the defined measurement path is post-processed into machine executable programming code.

Lin and Murugappan [77] proposed a framework for automatic CMM inspection probing planning. A three-phase approach was taken:

- 1) developing a general algorithm for path generation;
- 2) selection of a CAD system with an API (application programming interface);
- 3) implementation of the algorithm.

The main objective of this work is to develop a general algorithm for CMM inspection path generation, which can be implemented with any CAD system API. The algorithm assumed that the CMM probe is a point object. This helps convert collision detection of the moving probe with the part, into the simpler detection of collision of a single point with the part. Fixtures are not considered in this research.

### **2.1.3. Review of CAIPP Systems for OMM**

All the reviewed CAIPP research in the above sections is for CMMs only. CAIPP systems for OMM operations received very little attention before the mid 1990s. The main reason for this is that CNC machines were not able to provide high enough accuracy to carry out acceptable OMM operations. OMM was treated as a delay of production resources. However, this situation started to change when new generations of high accuracy and high performance CNC machines became available. Industry and researchers realized that certain OMM operations can be carried out in the machine centre to provide real-time, in-process measurement. With proper process planning, this type of in-process measurement can largely reduce scraps. Measurement data can also be used for evaluating machine performance and providing statistical data for quality and machine maintenance control.

Successful implementation of OMM in machining centres, however, requires robust and reliable hardware, software, and reliable data. A multi-tool capacity machine tool is often a must. An open architecture controller is also essential for inclusion of any additional probing software that may be needed. The measuring system which may be comprised of

different probes, sensors and electronic elements, is needed for implementing the OMM process on the machine tool. The feedback mechanism needs to be in place and in real-time.

CAIPP systems for OMM and CMMs are different. In the research carried out by Cho and Seo [78], the differences of inspection planning strategy for the OMM and CMM in CAD/CAM/CAI environment were analyzed. Figure 11 shows the inspection process planning comparison between OMM and CMMs.

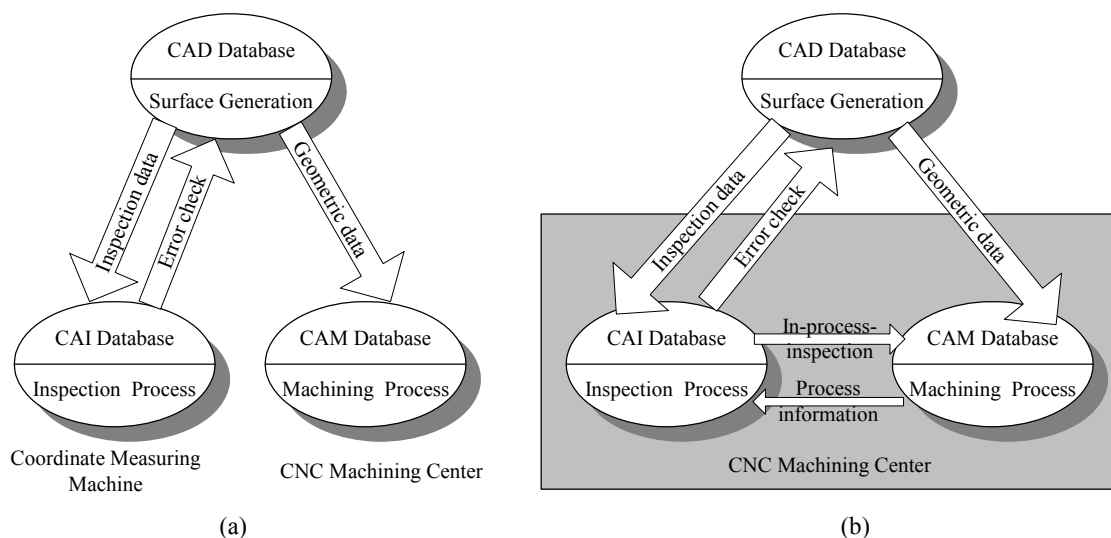

**Figure 11: CAIPP system using (a) CMM and (b) OMM**

The inspection feature selecting/sequencing module has the most differences. For those systems that use CMMs, the inspection feature selecting/sequencing module focuses on accessibility and collision detection, probing approach direction, etc. For OMM operations, whereby a part is machined and inspected on the same machining centre, machining feature sequence is the main consideration for inspection feature sequencing. The inspection feature selecting/sequencing module in CAIPP systems for OMM tends to focus on grouping inspection features according to the machining feature sequence. Probing accessibility and probing orientation are of minor significance for these systems. The related research is reviewed in the following paragraphs.

Wong *et al.* [23, 79] proposed a feature recognition approach for non-CMM inspections, based on the environment of the Generic Computer-Aided Process Planning Support



System (GCAPPSS) proposed by Yuen *et al.* [80]. Figure 12 shows the GCAPPSS system. A key feature of GCAPPSS is the Generic Object Information System (GOIS), which consists of a generic geometric feature recognition system, a feature relation identifier, and an object interpretation system. The GOIS accepts the object information from a CAD model data in the Extended Winged Edge Data Structure (EWEDS), and processes them through a feature extraction system to identify simple and complex features. The output of the generic geometric feature recognition system contains features that are different from the machining features. The feature relationship identifier receives this geometric feature information and establishes feature relationship information for the object interpretation system. This, in turn, provides machining and inspection process planning systems generic object feature information respectively.

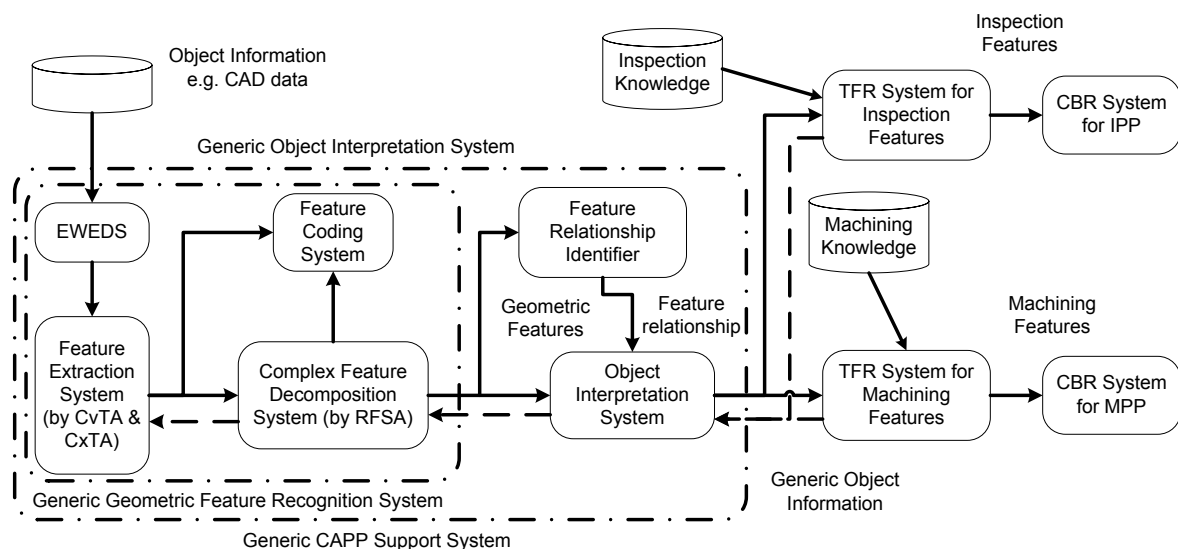

**Figure 12: Framework of GCAPPSS**

This research classifies the most frequently occurring dimensional inspection measurands into the following seven cases:

- 1) The distance between two parallel faces which can be length, width, gap, slot, fin, height, protrusion, depth, recess or thickness. The actual measurement process depends on the shape, size and orientation of the pair of faces of interest.
- 2) The diameter of a complete cylinder/hole.

- 3) The diameter or radius of a partial cylinder/hole or a cylindrical face.
- 4) The distance between a cylinder/hole and a parallel face.
- 5) The distance between a pair of cylinders/holes.
- 6) Coordinate measurement (or profile measurement) of a curved surface (free-form or otherwise) with respect to a bounded reference plane.
- 7) A combination of the above. A wide range of measuring equipment and length standards may be used during this stage.

One problem of the proposed algorithm is that it often generates enormous numbers of different inspection options. The authors have proposed a knowledge-based technique—by using a series of “filters” to subject individual inspection process.

Lee *et al.* at Inha University [15], Korean proposed an optimal inspection planning strategy (Figure 13) for workpieces comprising many primitive form features. This is a two-stage process:

➤ Stage I: Global inspection planning

At this stage, optimum inspection sequence is determined. First, the geometrical precedence of the features is determined by analyzing their nested relations, and then the features are grouped according to the extracted characteristics. Next, the inspection sequence of the feature groups is determined, and then the sequence of the features in each group is determined to generate a global inspection plan. The planning procedure is represented as a series of the heuristic rules developed. The application of the rules results in an inspection sequence of the features.

➤ Stage II: Local inspection planning

Each feature is then decomposed into its constituent geometric elements such as planes, circles, etc. The tasks of this local inspection planning are to determine the appropriate number of measurement points, their locations, and the optimum probing paths to minimize measuring errors and times.

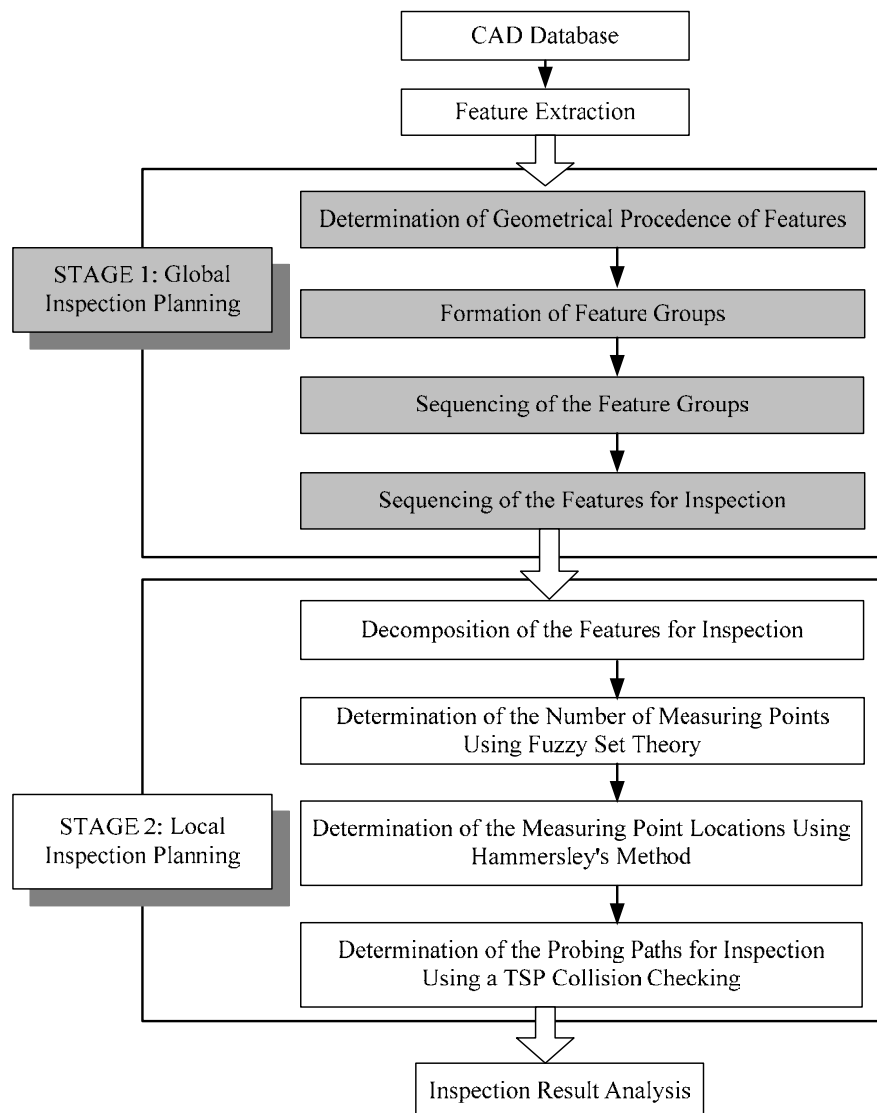

**Figure 13: The overall schematic structure of OMM process planning**

Chung, S. C. [16] proposed a CAIPP system for OMM operations on free-form surfaces. An Initial Graphics Exchange Specification (IGES) translator was developed to translate CAD/CAM output files into IGES files. Trimmed Non-uniform Rational B-spline (NURBS) surfaces are extracted through the IGES translator. Measurement codes are generated by means of coordinate transformation and the uniform sampling software (which is proposed in this research) linked with the IGES translator. The same techniques were used in the research carried out by Cho and Seo [78], where CAM and CAIPP are integrated by taking into account the geometric information of machined surfaces. For this purpose, the analysis of the machined surface shapes was performed in order to carry out

the CAIPP effectively. This analysis corresponds to the machining error prediction process, which predicts the machined surface shape. The key is to simulate the geometrical form of the machined surface. Machining errors can then be predicted by comparing this simulated machined surface with the designed surface in the CAD system.

For the rest of the CAIPP modules, the techniques used for CMMs process planning can be employed for OMM operations. Techniques for selecting proper measurement points and generating probing paths for OMM operations are mostly “borrowed” from the research for CMMs.

## 2.2. Recap of CAIPP Review

The above section reviewed CAIPP research in the past twenty years. The research on CAIPP started from mid 1980s. Before the mid 1990s, CAIPP research is more at a conceptual level that is to investigate what modules should be included in a CAIPP system. Four modules have been identified through these research efforts. They are the inspection feature selecting/sequencing module, the measurement/sampling points selection and optimization module, the probing path generation module, and the inspection execution module. Recent CAIPP research (after the mid 1990s) focused on one or some of these modules. In the meantime, non-CMM inspection operations started to attract attention from industry and researchers. CAIPP systems for non-conventional measuring devices and operations became another research trend. As a consequence of all these research efforts on CAIPP systems, greater automation has been achieved in today’s inspection process planning. However, there are still some key issues that need to be addressed.

- Firstly, inspection process planning has been mainly carried out in isolation from machining process planning. This does not present a major problem for inspections carried out on a CMM, as the inspections are carried out in isolation from machining physically. As a matter of fact, it has been deemed acceptable to consider machining process planning and inspection process planning in tandem. However, when inspections need to be carried out in-between manufacturing processes as in OMM, the status-quo method becomes inadequate. Inspection process planning needs to be considered together with machining process planning.

An optimal machining sequence without OMM operations may no longer be optimal when OMM operations are placed and intertwined with the machining operations.

- Secondly, employing OMM for inspection during machining may be advantageous in the context of process control. However, the use of non-standard bespoke canned cycles (as those for machining operations) with very limited mechanisms for feedback of inspection results prohibits the desired integration of inspection with machining operations.
- Thirdly, research around OMM has focused on offering one-off solutions rather than integrated solutions in that inspections are treated as part of the integral product development chain. Such problems have already been recognized among dimensional metrology systems [81].

To explain why these issues exist, it is necessary to take a look at a broader perspective – dimensional metrology. The total dimensional metrology process can be divided into four major interacting elements: product definition, measurement process planning (CAIPP systems), measurement process execution, and analysis and reporting of quality data [82]. Figure 14 shows the relationship between these four elements in an IDEF0 (Integration Definition for Function modelling) activity model.

Production definition (A1 activity in Figure 14) is the process whereby a part is designed through CAD design software based on customer requirement. From the perspective of dimensional metrology, the most important functions of the product definition activity is to provide sufficient information to permit the automatic generation of a downstream measurement process definition activity (A2 activity in Figure 14). Such information must include things such as part geometry, features, tolerances, and relevant manufacturing information (e.g., surface finish and material properties).

The measurement process definition activity (A2 activity in Figure 14) produces a process plan to measure the part so that the functionality of the part is ensured during/after manufacturing processes. From a dimensional metrology point of view, the most important functions of this activity are:

- 1) to extract or accept as input (from the product definition model, dimensional measurement equipment specifications, etc.) all the information necessary to generate a complete measurement process plan (called the macro process plan), and
- 2) to generate a device-independent micro process plan containing the necessary information to execute the part inspection process.

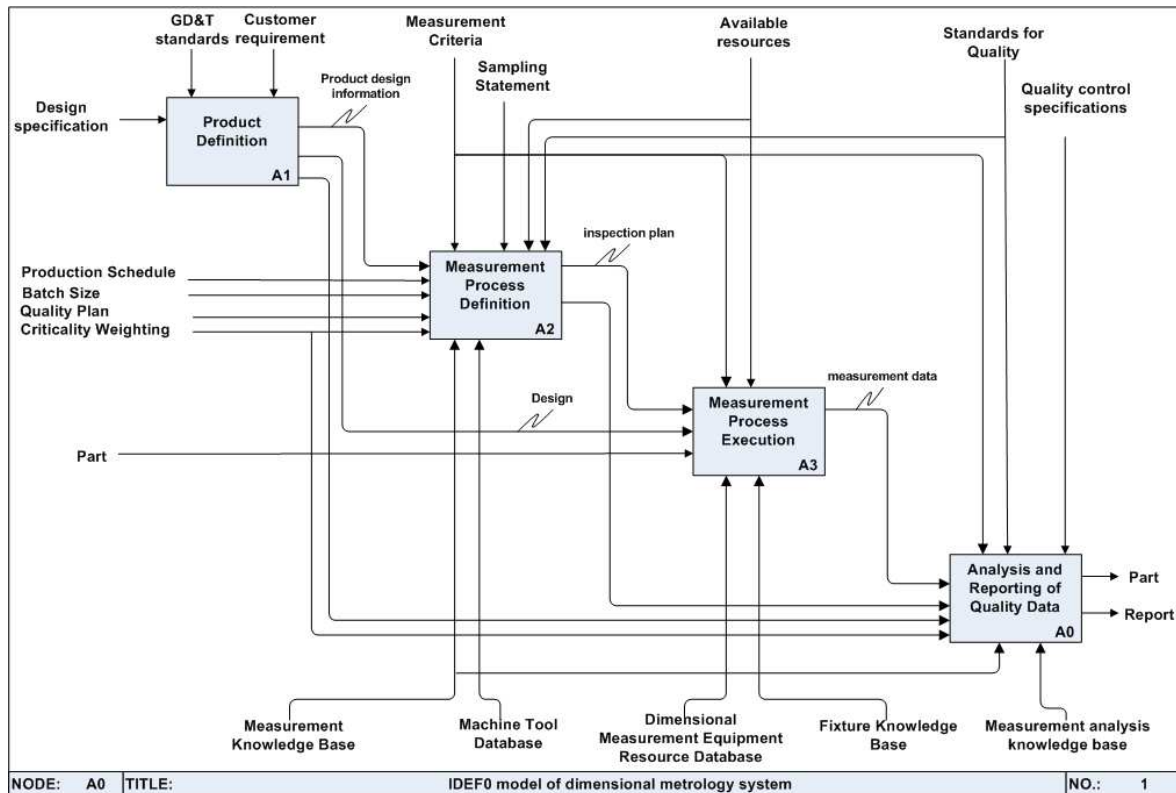

Figure 14: IDEF0 model of dimensional metrology system

To generate the measurement process plan, information such as part material, machine accuracy, and measuring constraints need to be considered to support the following decision making:

- what measurements to make and in what order
- which features need to be measured
- what are the measurands (measurement methods)
- what are the measurement purposes
- how to handle outliers and filter measurement results

- among available measurement resources, which (measurement device, sensor) pairs, if any, will successfully accomplish the measurement

Within macro process planning, additional tolerances and manufacturing information can be defined for different manufacturing environments. Based on manufacturing information (such as manufacturing features, manufacturing operations, etc.), tolerance requirements, and measurement purposes, measuring features and measurands can be decided. Following the macro process planning activity, micro process planning is carried out to generate a detailed measurement program, including precise measurement paths and measurement points, along with instructions for recording and reporting. Figure 15 shows the IDEF0 diagram of measurement process definition activity. It can be viewed as a high-level overview of all the functions/sub-activities that must be supported in order to generate a measurement process plan for use by the downstream execution of the part measurement process. Some of these functions/sub-activities are performed intelligently by today’s software, while others require manual intervention.

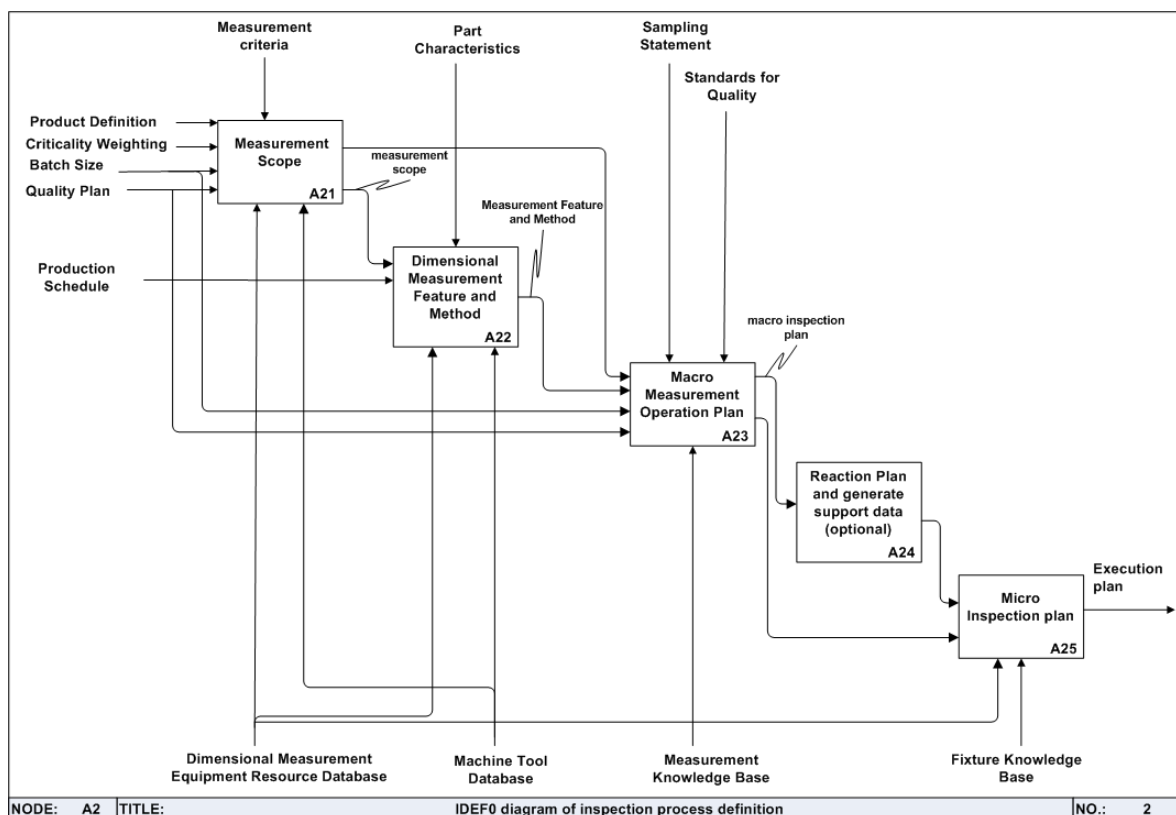

Figure 15: IDEF0 diagram of measurement process definition activity

The CAIPP systems and their related research is part of the measurement process definition activity. The previously reviewed CAIPP systems covered some of the tasks in the measurement process definition activity at both macro and micro level, such as deciding measurement features, generating inspection program (probing commands), etc. The measurement process definition activity is followed by inspection process execution activity.

From a very high-level perspective, the measurement process execution has the following important functions:

- 1) to accept input from the measurement process plan and use the input to provide unambiguous instructions to a variety of measurement equipment,
- 2) to use the measurement equipment to inspect the part,
- 3) to save the measurement results and provide output to the analysis and reporting activity.

This activity is not as simple as it sounds. It needs to support not only a huge number of different types of measurement equipment, but also an almost limitless number of ways in which a complex part can be inspected. If the measurement process plan generated from the upstream is not complete or unambiguous, corrective actions must be taken before this plan is executed on the chosen measurement equipment. For example, a translation process may need to be carried out to translate the measurement process plan into the format that is compatible with the available equipment.

Following the measurement process execution activity is the analysis and reporting activity. The most important functions of this activity is to

- 1) receive input from measurement process execution and product definition activities,
- 2) analyze the part measurement data in terms of production definition requirements,
- 3) perform a statistical analysis of the measurement results and present them in the form of a statistical process control report, and
- 4) archive whatever measurement values and derived statistics are necessary for things like legal protection.



The above summarized issues in CAIPP systems are related to the way CAIPP systems are integrated with other three dimensional metrology elements. The current situation is that there is a major problem in exchanging information between any of the two dimensional metrology elements. The following section explains the cause of the current situation.

### 2.3. Dimensional Metrology Interoperability Issues

In the industry, there is a range of commercialised software for different manufacturing activities such as designing, process planning, etc. The commercial software systems related to dimensional metrology can be categorized into four groups corresponding to the four main elements of dimensional metrology systems as it is shown in Figure 16. Barriers (represented by the dotted lines in the figure) exist not only between these four elements but also within some of the element itself.

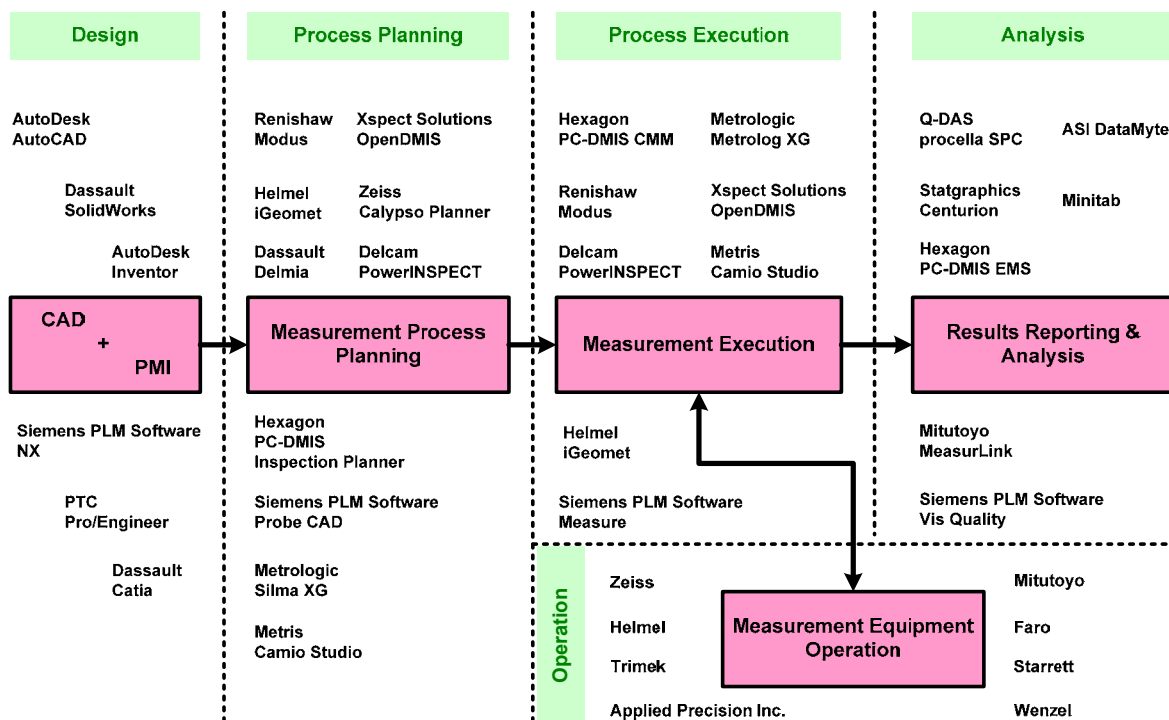

Figure 16: Interoperability barriers between dimensional metrology commercial software systems

Figure 17 depicts, in large measure, the current status of dimensional metrology systems. The functions/tasks that each element of a dimensional metrology system should

accomplish are depicted in the yellow rectangles in the figure. The commercialized software in each category carries out the tasks in its own proprietary data format. Take product definition as an example: if a product geometry is generated using one commercial design software, it can not be immediately accepted by another design software for modification. If a design is passed for measurement process definition, the same issues exist between design and measurement process planning software.

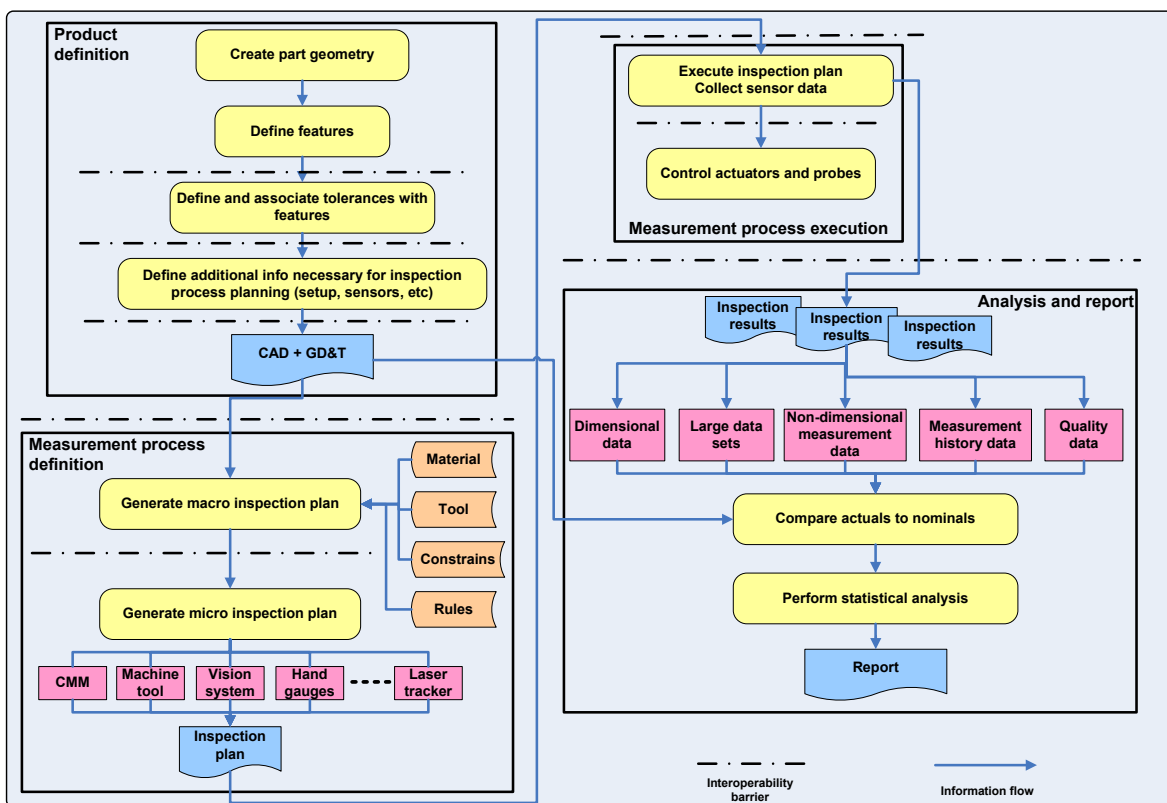

Figure 17: Current-state dimensional metrology interoperability issues

The rectangles in pink colour in the figure shows the devices that are commonly used in the industry to carry out measurement operations. Software interfaces for different devices might take different data formats. Therefore, interoperability issues also exist in integrating different measuring devices to the system. The horizontal lines represent the boundaries that prevent information flow seamlessly within and between elements of dimensional metrology systems. Key interoperability issues occur within each of these four elements and when information is passed between any two or more of the elements. In the following sub-sections these key interoperability issues are introduced.

### 2.3.1. Product Definition

To support automatic dimensional metrology plan generation, the simplest case, where the product consists of a single monolithic part, can be selected as an example. The part must be decomposed into geometric features. Dimensions and tolerances must then be assigned to a geometric feature, or set of features. Datum features must be defined in such a way that they are appropriate both for manufacturing the part and for inspecting it. It is not uncommon that datum features are not the same for manufacturing and for inspecting purposes. Surface texture information must be included in the model, along with relevant information about the orientation or lay of the surface texture to be measured. Accurately extracting this type of information would require interaction with the manufacturing process plan, which defines the process used to create the surface that is to be measured. Therefore a process definition that defines the manufacturing and measuring process must be interconnected with elements within the product definition. Furthermore, the process requires resources (sensors, fixtures, machines), and therefore a resource definition that supports the process definition must be represented [83].

However, this does not exist in the current manufacturing world. The main issues exist in the product definition activity are summarised as follows:

- 1) Product Manufacturing Information (PMI) is only limitedly available in proprietary software. There are no CAD product implementations of PMI information using non-proprietary standards. PMI includes elements such as Geometric and Dimensional Tolerancing (GD&T), surface finish, optical properties, and material properties.
- 2) GD&T data needs to be modelled in CAD data, not just given as annotations. ISO 10303 (also known as STEP) Application Protocol (AP) 203 [84] (boundary representation) is the only design data standard representation supported by all CAD systems but it does not model tolerance items such as datum features, tolerances, etc. ISO 10303 AP 224 [85] (feature representation) models tolerance items but does not supported by CAD systems.
- 3) There are divergences in the interpretation of GD&T paper standards both at national and international level (e.g., ASME Y14.5 and equivalent ISO standard).

At the international level, different national GD&T standards exist and they are not completely convergent with each other. At the national level, some major companies differ in their interpretation of the GD&T standards. Interoperability suffers under these realities, but is not destroyed.

Currently, one of the major efforts in standard society is to develop a new version of ISO 10303 AP 203 that models tolerance items. The most recent test was carried out by some major CAD vendors on GD&T information modelled in AP 203 edition 2 [86]. The GD&T definition from AP 214 [87] (Core data for automotive mechanical design process) was harmonized into AP 203 edition 2. These GD&T definitions are mainly for annotation purposes, therefore they are not sufficient for automatic generation of dimensional inspection process plans. Further harmonization of GD&T definitions between AP 214 and AP 224 is necessary and the harmonized definitions should be eventually adopted into AP 203. Only in this way, is AP 203 able to provide adequate information for generating effective inspection process plans.

### **2.3.2. Measurement Process Definition**

The measurement process definition activity takes the finished part shapes generated from a CAD system. Intermediate workpiece shapes and feature shapes are output from routing planning, inspection planning, and machining planning software modules. Many different proprietary formats exist and human intervention is mostly unavoidable in this activity in industry today. There are difficulties not only in information exchange between different measurement process plan software systems, but also in automatic inspection generation. Moreover, the measurement process is required to do more than just inspect the part for conformance to the key dimensions on a drawing in today's manufacturing environment. It also should provide:

- feedback needed for control of the manufacturing process,
- statistical data for the evaluation of conformance to tolerances at the feature level,
- manufacturability feedback to the product definition activity, and

- information or data for machine calibration (such as machine performance, measurement uncertainty, and configuration) from the downstream CNC machine or CMM end to the upstream manufacturing process planning.

However, the measurement process definition has some major issues hindering the realization of interoperability and automation. These issues are listed as follows.

- 1) No standard GD&T information is associated with part design geometry. This issue is a crosscutting issue which exists both in production definition and measurement process definition activities.
- 2) No standard mechanism to capture and no standard language for measurement methods, practices, and rules.
- 3) No computer-readable and standard resource definitions of measurement equipment capability, capacity, available configuration, performance, measurement uncertainty, sensors, fixtures, rotary tables, etc.
- 4) Weak end-user support for non-proprietary metrology system interface languages

Lack of end-user support is the single most critical impediment to interoperability. All other impediments are derived from it.

DMIS is the only standard that defines measurement instruction data within the measurement process definition activity. It is a language for controlling dimensional measuring equipment and includes an input and an output language. Part of the DMIS input language defines features, tolerances, sensors, etc. The output language serves both as a log of action commands and settings and as a report of results, with actual and nominal point data, features, and tolerances. However, it does not define complete measuring equipment resources. Measuring equipment resource data is necessary to complete the effectiveness of DMIS. An independent testing and certification service is useful in determining a broad set of conformance classes that would function as common knowledge among frequent DMIS users as to which class is required to do which type of job [88]. NIST has developed a DMIS Test Suite 2.1.4 for DMIS version 5.1 [89] to help users and vendors use version 5.1 of the DMIS and to support DMIS conformance testing. DMIS conformance and certification is an ongoing effort.

There are various standards that define some measuring equipment capabilities and resource configurations. For example, DMIS includes some definitions of CMM configuration. Inspection++ Dimensional Measurement Equipment (I++ DME) and Renishaw use eXtensible Markup Language (XML) to define machine configuration. ISO 10360-1 [90] has definitions of machine types. These standards need to be assessed and harmonized.

### 2.3.3. Measurement Process Execution

Activities within the measurement program execution system include interfaces between executing low-level inspection tasks and executing high-level instructions. Measurement process execution activity needs to handle both a variety of measuring equipment and nearly limitless ways of measurement. The interoperability issue in this activity is more important in large, enterprise-level corporations, where a single-vendor solution is impractical if not impossible. An equipment-independent data format for representing both high-level and low-level measurement process execution plan is necessary and critical for big corporations. However, there is no such standardization in industry. There are two publicly available specifications for the interface between high-level process plan execution and low-level process plan execution. One is the Equip module of DMIS Part 2 [91] which has been formalized as an American National Standards Institute (ANSI) standard. The other is the I++DME Interface Specification [92] which is a specification for dimensional measuring equipment information exchange developed by several European automakers and measuring equipment vendors. There are no known product implementations of the Equip module of DMIS Part 2. There are many software implementations of I++DME worldwide, but it is not yet ubiquitous for either CMM software or CMM systems to offer I++DME in their published product offerings.

Interfaces between executing low-level measurement process plan is also another major barrier for interoperability in this activity (shown in Figure 16). Many proprietary APIs exist in low-level measurement instruction commands. Therefore, the pressing issues in measurement process execution activity are:

- 1) I++DME is not a formal standard,
- 2) I++DME needs to be extended to handle more equipment, sensors, and environment,
- 3) Implementation barriers of I++DME need to be reduced, such as the entry cost and intellectual property issues.

Renishaw and other vendors have I++DME simulators available to enable quick and accurate development of I++DME implementations within measurement plan execution software. The CMM industry and NIST have also developed an I++DME test suite. The I++DME conformance test utility software has not been maintained to comply to the latest version of I++DME, but can still be of value to enable I++DME implementations that can be quickly developed and that are compliant to the specification.

#### **2.3.4. Analysis and Report**

The METrology Project Team (MEPT) of the Automotive Industry Action Group (AIAG) has created the Dimensional Markup Language (DML) [93] which defines measurement feature actuals and nominals for a CMM, sufficient for complete reanalysis of derived values, such as feature dimensions. In partnership with the AIAG, the Dimensional Metrology Standards Consortium (DMSC) is progressing DML to ANSI and ISO standardization. DML is having moderate usage largely in North America. A format for CMM measurement results is defined within DMIS, and has enjoyed some usage, wherever DMIS is used.

Within the STEP effort, AP 219 [94] was defined to cover all important metrology information, including, but not limited to, measurement results. The latest ISO standard version of AP 219 defines only measurement results information.

Harmonization between DMIS, AP 219, and DML for providing a standardized measurement data format is essential. There are multiple standards/specifications that define traceability data such as DML and ISO 10303 AP 238 [95]. However, the link between traceability and measurement data is insufficient. Part of the current effort on DML is to ensure that DML is consistent with both GD&T paper standards like ASME Y14.5, STEP AP 219, and DMIS.

There is no comprehensive standard science or standard methodology for adjusting a manufacturing process based on analysis of quality data. To realize this, an unambiguous statement of the causal link between events/trends in measurement results and elements of the manufacturing processes is necessary. As a result, the causal link between quality control results and the process is known only by human experts, so human intervention is needed to carry out appropriate process adjustments manually. There are also multiple standards/specifications to perform statistical analysis of quality data, such as American Society for Quality (ASQ) [96] and ISO 16949 [97]. The standardization and harmonization of these standards/specifications is necessary.

From an information exchange standards' perspective, the main existing issues in the analysis and reporting activity are:

- 1) lack of understanding and definition of how measurement results and summary statistics can be used to improve the manufacturing process, e.g., current measurement activities are still largely used to accept or reject parts, instead of as a feedback to manufacturing process and part design improvements,
- 2) lack of a uniform data model for traceability,
- 3) lack of consistency of statistical calculation methods and definitions, and
- 4) present lack of a standard data format for measurement data and single part report, although DML is expected to be promoted to an international standard soon.

Measurement data feeds into the analysis and reporting activity from various sources. Measurement data of the same type from different sources should be in the same format.

Dimensional metrology systems encompass a large number of software and hardware systems. The interoperability issues that exist in dimensional metrology systems as introduced in the above sections are numerous and cannot be resolved in a short time. However, due to the potential and substantial payoff, it is worthwhile to exert efforts to achieve interoperability within dimensional metrology systems.



### 2.3.5. Crosscutting Interoperability Issues in Dimensional Metrology Systems

Among all the interoperability issues summarised in the above sections, one of them is a crosscutting issue that currently has an adverse effect on every aspect of the dimensional metrology process – CAD data is not properly associated adequately with GD&T and Product Lifecycle Management (PLM) information. GD&T and PLM information cannot flow seamlessly to downstream processes when components are not from the same vendors.

There is no shared vision between vendors and users on this issue. There is a lack of consensus on whether the exclusive open-source, non-proprietary, standards-based hardware and software is a more effective option than single-supplier network, proprietary hardware and software. STEP and STEP-NC standards are the major effort towards resolving this issue. STEP and STEP-NC, as the international effort to achieve interoperability for manufacturing systems, are broad in scope compared with other metrology standards covering all aspects of manufacturing, inspection included. They also provide high quality, open, and non-proprietary data model. It is believed that STEP and STEP-NC provide a promising resolution for achieving interoperability between these interfaces.

Four parts of STEP standard (AP 203, AP 224, AP 219, and AP 238) provide standardization of information flow between CAD, machining process planning, and measurement process planning: AP 203 and AP 224 for information exchange between CAD and machining process planning, AP 203 edition 2 and AP 219 for information exchange between CAD and measurement process planning, AP 219 and AP 238 for information exchange between machining process planning and measurement process planning. Due to the complexity of the standard and the lack of implementation, there are some negative views in the dimensional metrology community. Nevertheless, STEP is still the most comprehensive standard that deals with this crosscutting interoperability issue. However, STEP/STEP-NC standards are not yet complete in terms of GD&D definition, measurement device definitions, and some of the process related information definitions.

### 2.3.6. Recap of Dimensional Metrology Interoperability Issues

Dimensional metrology system is a broad definition including a large number of software and hardware systems. The language of communication across the interfaces between these components is typically proprietary. This proliferation of proprietary interface languages can be very costly to users, suppliers, vendors, and customers. Meanwhile, many standards/specifications exist covering different aspects of information exchange in dimensional metrology systems. Figure 18 depicts the current metrology interoperability standards landscape.

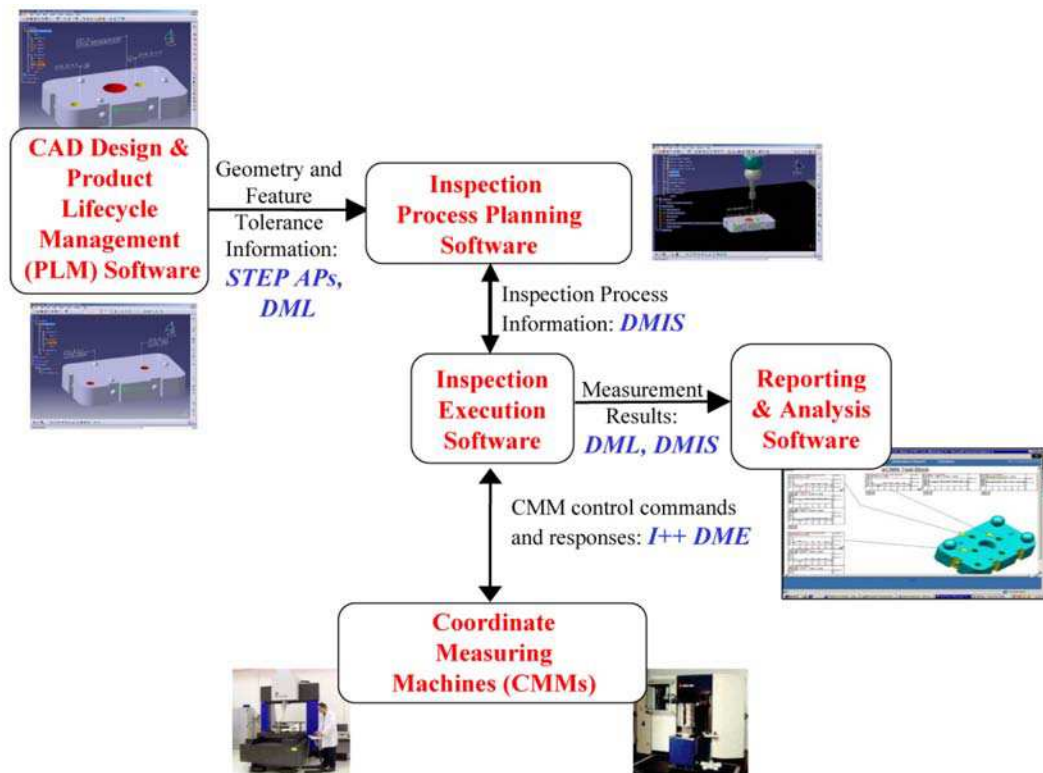

**Figure 18: The current metrology interoperability standard landscape [83]**

The current interoperability issues occur both within each of the four elements and when information is passed between any two of the elements in dimensional metrology systems. Not only most of the metrology standards are still underdevelopment, some of the developed standards are not as widely accepted in industry as some specifications. Also, some of the standards or specifications overlap with each other.

Interoperability issues in dimensional metrology systems can not be solved in a short time. However, it is worthwhile to pay efforts to achieve interoperability within dimensional metrology systems. As shown in Figure 19, without all the boundaries between different software/ hardware systems the dimensional metrology system can be much more efficient. Different commercial software can be integrated to work for one complete dimensional metrology system. Also, measurement result can be collected in a real-time fashion and analysed swiftly by analyzing software. Feedback and update can be passed onto process planning for both machining and inspection to achieve real-time, closed-loop control.

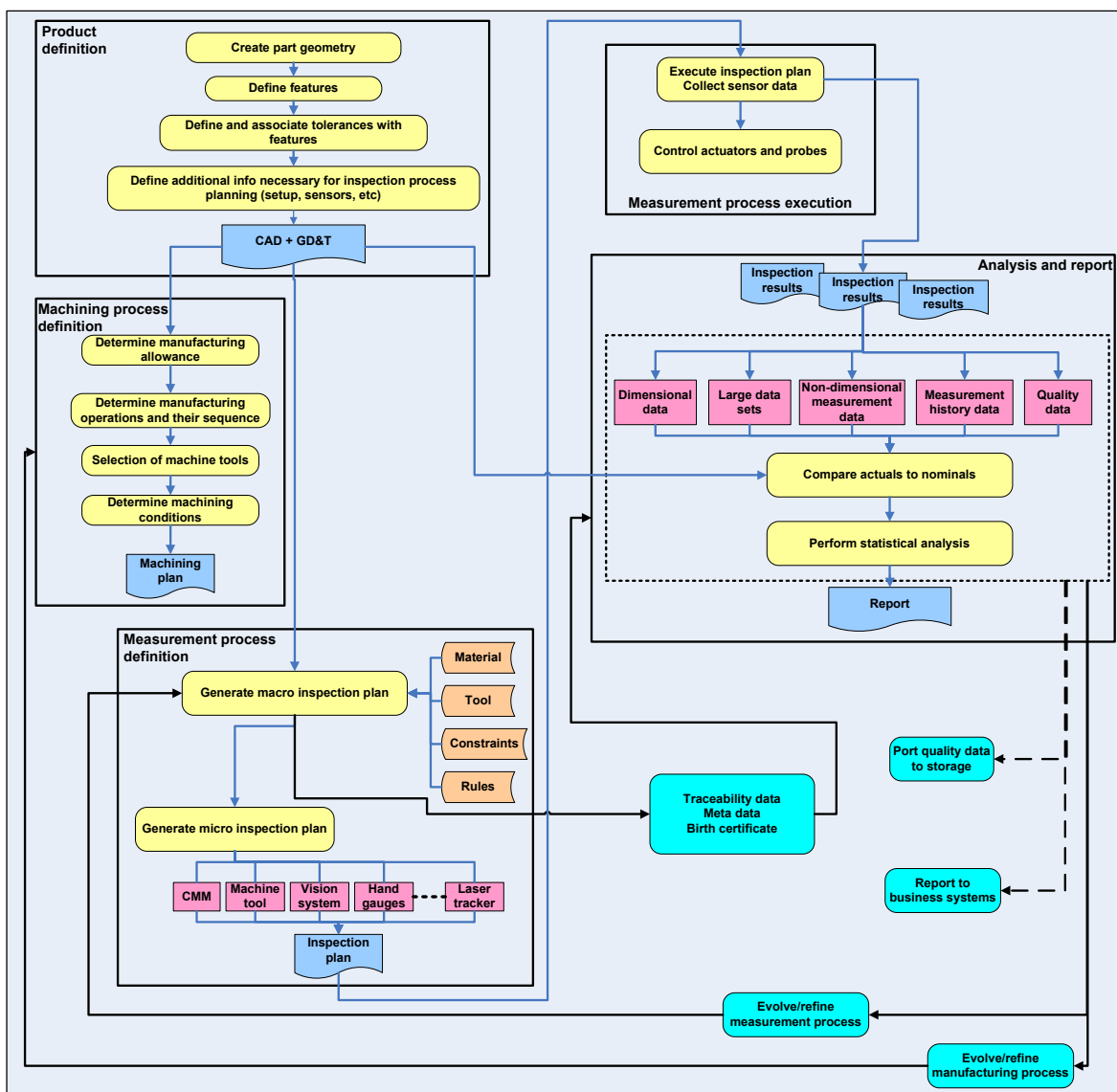

Figure 19: Future vision of dimensional metrology system

## 2.4. Recap

A thorough review of CAIPP was carried out to identify the tasks that inspection process planning needs to accomplish. It is found that CAIPP system/research mostly focuses on using CMMs to carry out inspection, which is a post-process not in-process activity. Very little research concentrates on developing CAIPP for in-process measurement. CAIPP for both OMM and CMMs is largely isolated from machining process planning. CAIPP for OMM especially needs a lot of human intervention. Therefore, the inspection process is not effectively involved in the efficient control of the machining process. To investigate why this kind of isolation exists, considering only CAIPP systems is not enough. It is vital to look at it from a broader viewpoint – the dimensional metrology system – which CAIPP as one of the four elements belongs to. A detailed overview and discussion of dimensional metrology interoperability issues has been given. It is clear that a lack of interoperability exists between any two elements in a dimensional metrology system. These interoperability barriers are the main reason that CAIPP systems are isolated because only very limited information is provided to CAIPP. It is found that the current part inspection programs commonly generated by CAIPP systems are either based on the DMIS or a vendor-specific bespoke routine. Also, process control for both machining and OMM operations of components at the CNC machine tool level is achieved through bespoke machining and inspection programs based on G&M codes [98]. The low level information that G&M codes and DMIS language carry means that CAIPP systems can not be fully integrated with either product definition or machining process planning systems. For example, GD&T requirements, which are essential information for decision-making in CAIPP systems, are not fully defined and cannot be passed seamlessly from product definitions to CAIPP. Thus, measurement operators may need to intervene in process planning to help choose measurement features for in-process measurement; otherwise all features are measured regardless of GD&T requirements in post-process measurement. Neither is ideal for modern industry.

This research aims to develop an automated process planning system integrating machining and in-process measurement for CLM. To facilitate this proposal, developing a consolidated data model comprising the information of GD&T, machining features and operations, inspection features and operations, and measuring devices is the first and

foremost task to accomplish. As discussed, STEP/STEP-NC standards are by far the most comprehensive standards for product definition throughout the lifecycle of a product. This characteristic of STEP/STEP-NC makes them the best candidate to provide consolidated information for the proposed integrated process planning system.

However, STEP/STEP-NC are relatively new standards; they are not complete and many parts of the standards are still in draft form. Some necessary information for the integrated process planning system is not defined in STEP/STEP-NC. Therefore, they are still unable to support automated inspection process planning integrated with machining process plan. This research first investigates the current Parts and drafts of STEP/STEP-NC, identifying what additional information is needed to be defined. Then, a STEP Application Protocol ARM data model for integrated CNC machining and inspection has been developed in this research. This proposed data model, which is harmonized through existing STEP/STEP-NC Parts together with newly defined information and mechanism that links GD&T and machining features, provides sufficient information for the proposed process planning system. The detailed description of STEP/STEP-NC and this proposed data model is presented in Chapter 3.

# *Chapter 3 STEP and STEP-NC*

This chapter gives a detailed account of the emerging ISO standards that are briefly introduced in the last chapter, i.e. STEP and STEP-NC. Firstly, the chapter gives an overview of STEP, its history and objectives. This is followed by the introduction of technical details of (1) information modelling using EXPRESS and EXPRESS-G, (2) data representation using STEP Part 21 [99] format and other methods, (3) STEP integrated resources, (4) Application Protocols, Application Activity Models (AAMs), Application Reference Models (ARMs), Application Interpreted Models (AIMs), Units Of Functions (UOFs), Application Modules (AMs) and conformance classes, and (5) STEP-NC. The logical relations between STEP and STEP-NC are also addressed.

## **3.1. A Snapshot of STEP**

STEP, the Standard for the Exchange of Product Model Data, is a large and powerful set of ISO standards; all under ISO 10303. The overall objective of STEP is to provide a mechanism that describes a complete and unambiguous product definition throughout the life cycle of a product [100].

### **3.1.1. Overview of STEP**

A typical use of STEP can be given in the following scenario. An automobile engine designer working with a commercially available CAD system designs an engine block. The CAD system's native representation of the design is proprietary to the vendor of the system, but a STEP output module has been included within the CAD system that translates the proprietary representation into a representation using the STEP application protocol for configuration controlled design (AP 203). The AP 203 representation is saved in a STEP data file using Part 21 of STEP. The engine block design is sent to a manufacturing plant by sending the STEP Part 21 file for the design. At the manufacturing plant, a manufacturing engineer using a CAD system from a different vendor tells the CAD

system to read the STEP file. This is possible because the second CAD vendor has also implemented STEP AP 203. The system has a module that read the STEP file and build a representation of the design in the second CAD system's native format. With the design now resident in the CAD system, the manufacturing engineer goes to work figuring out how to manufacture the engine block. If the manufacturing engineer wants to suggest a change in the design, he or she can have the CAD system write a STEP AP 203 Part 21 file and send it back to the designer. It is also possible to use STEP to communicate design information at the feature level (AP 224) and manufacturing information at the operation level (AP 238) [101].

Figure 20 describes the data – manufacturing data exchange scenario enabled by STEP. The geometric representation data described in STEP AP 203 or other formats are translated into machining features defined in AP 224. The machining feature definitions are used as inputs to macro process planning applications (e.g. AP 240 for machining, AP 223 for casting, and AP 229 for forging). Micro process planning for machining (AP 238) and inspection (AP 219) are then carried out for each of the aforementioned application processes. In such a system, the need for data conversion is eliminated [3].

### 3.1.2. History of STEP

The evolution of STEP can be divided into two release phases. The first major release of proposed STEP documents occurred in 1988, when a large set of models had been assembled into a single “Integrated Product Information Model” (IPIM). Half a dozen documents from the IPIM were adopted as initial drafts of ISO standards at an SC4 (Sub-Committee 4) meeting in Tokyo in late 1988. By 1989, STEP had focused on the concept of AP as a subset of STEP that would be intended for a specific industrial use and could be implemented and subjected to conformance testing. The architecture for APs was developed in the following few years. It was apparent from the beginning of the use of application protocols that developing and using them were difficult. In addition, it frequently occurred that different application protocols would use the same type of information (particularly geometry and topology). This led to the development of methods of modularizing APs. The first version of STEP to become an ISO standard was adopted in 1994 and companies such as GE, Boeing, and General Motors began announcing

commitments to using STEP in 1995. In 1994/95 ISO published the initial release of STEP as International Standards (IS) with ISO 10303 Parts 1, 11, 21, 31, 41, 42, 43, 44, 46, 101, AP 201, and AP 203 [102].

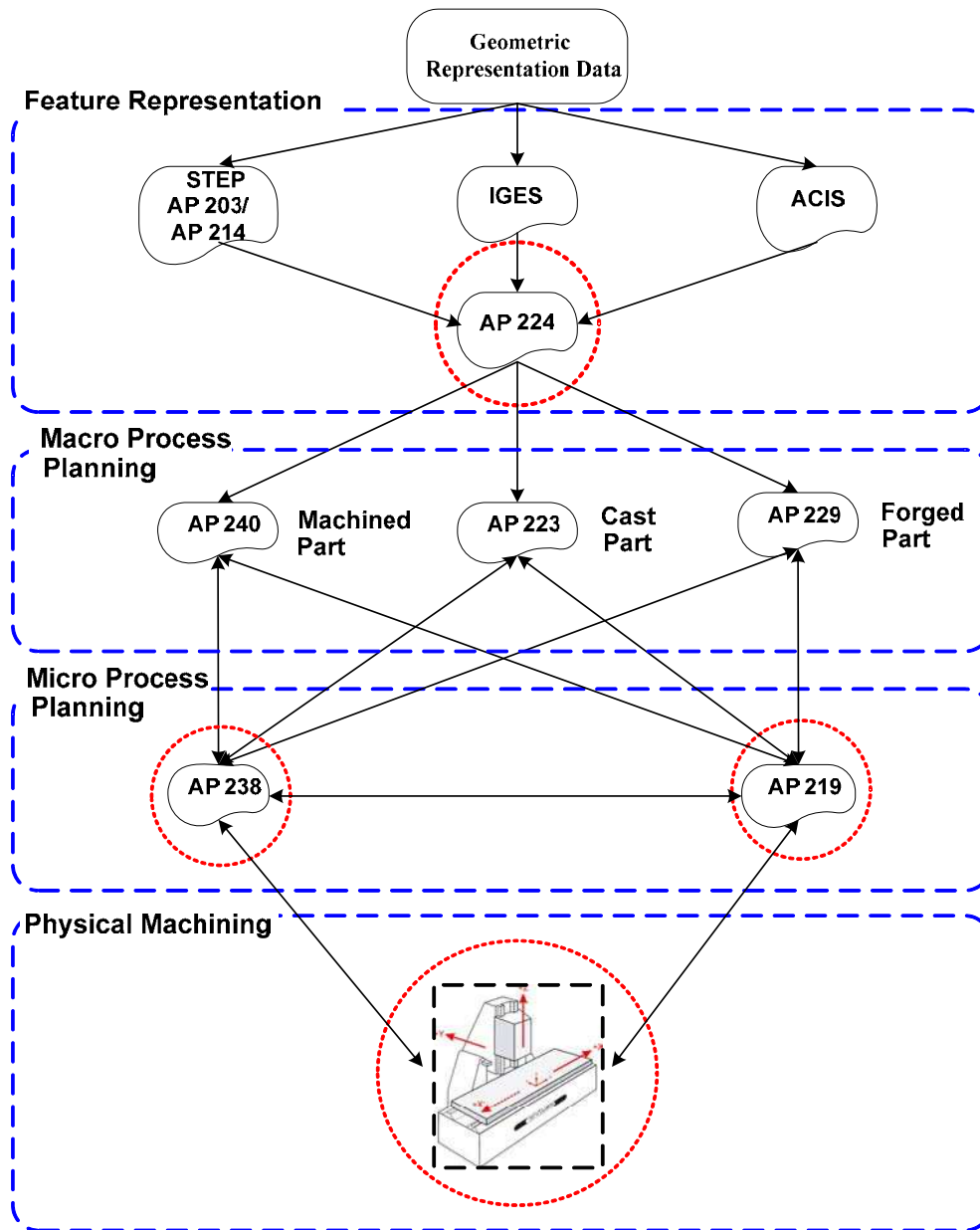

Figure 20 Design – manufacturing data exchange enabled by STEP

In the second phase, the capabilities of STEP got widely extended, primarily for the design of products in the aerospace, automotive, electrical, electronic, and other industries. This phase ended in the year 2002 with the second major release, including ISO 10303 APs



such as AP 202, AP 209, AP 210, AP 212, AP 214, AP 224, AP 225, AP 227, and AP 232. As of June 2008, the SC4 web site [103] lists 23 application protocols that have become international standards [100].

### 3.1.3. Objectives of STEP

The purpose of STEP, as stated in the document giving the fundamental principles of STEP [20] is “to specify a form for the representation and unambiguous exchange of computer-interpretable product information throughout the life of a product”. STEP permits different implementation methods to be used for storing, accessing, transferring, and archiving product data. From the beginning of STEP, many STEP developers have held that supporting sharing is essential. Although sharing is not among the purposes stated in the fundamental principles document, the introduction to that document says that STEP will be “suitable not only for neutral file exchange, but also as a basis for implementing and sharing product data bases.”

Additional objectives of the original developers of STEP included the creation of a single international standard covering all aspects of CAD/CAM data exchange and the implementation and acceptance of this standard by industry in lieu of other methods [104-107].

## 3.2. Structure and Technical Details of STEP

The STEP standard is separated into many parts. These parts cover from presenting the standard, implementation architectures, conformance testing, resource information models, and application protocols. The parts are called Description Methods, Information Models, Application Protocols, Implementation Methods and Conformance Tools. Figure 21 illustrates the structure of the STEP standard.

The Parts of STEP may be grouped by type as follows. The Parts are numbered so that all Parts of the same type fall in the same number range. The range is given below after the type. Not all numbers are used. There are several hundred application modules. The total number of Parts of the other types listed below is about 120.

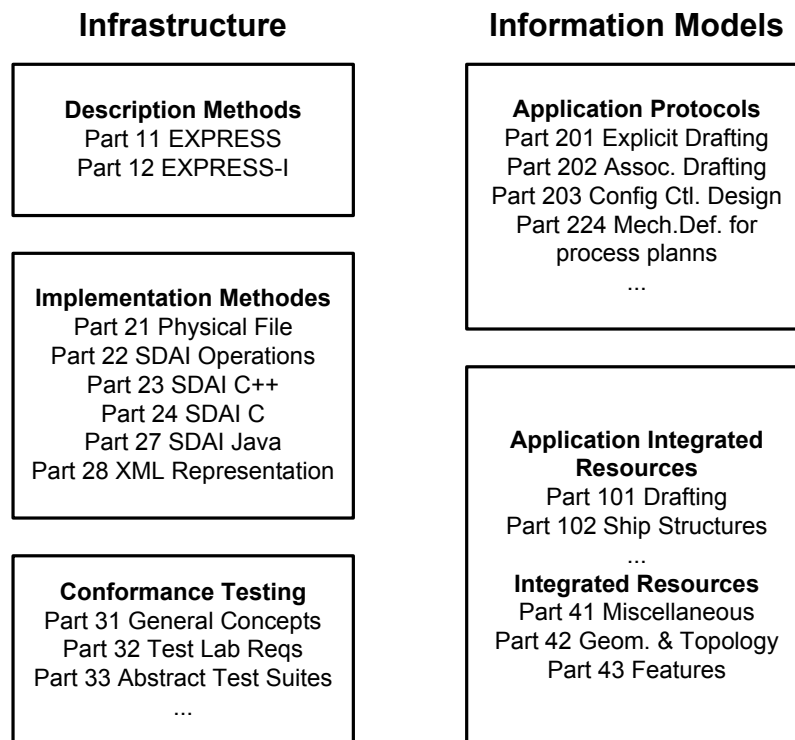

**Figure 21: Structure of the STEP standard [20]**

➤ Overview and fundamental principles (1)

This is a single document giving an overview of STEP and an exposition of its fundamental principles.

➤ Description methods (11-19)

These cover the information modelling language EXPRESS and its graphical form, EXPRESS-G.

➤ Implementation methods (21-29)

These cover methods of representing data that has been modelled in EXPRESS.

➤ Conformance testing methodology and framework (31-39)

These give the general concepts of conformance testing as well as actual test methods and requirements on testing labs and clients.

➤ Application protocols (201-299)

These are the Parts intended for implementation in industry. As described in more detail below, each application protocol includes several documents.

➤ Integrated generic resources (41-59)

These are EXPRESS information models of widely useful specific subject domains, such as geometry, topology, and tolerances.

➤ Integrated application resources (101-199)

These are EXPRESS information models of more narrowly focused specific subject domains.

An application protocol can be built by including a (usually large) number of application modules. Using application modules is a more recent architectural approach than using application interpreted constructs and may replace application interpreted constructs.

### 3.2.1. Description Methods

The description methods are defined via the data modelling language, EXPRESS. EXPRESS is a completely generic modelling language and can, therefore, be used to model data objects of any type. It is a formal language for the definition of entity-attribute data models. Its original use was for the definition of standard data models describing 3D graphical representations of physical objects, i.e., CAD drawings. The EXPRESS language is completely declarative and implementation independent, making it well suited for the definition of standardised data models. On the other hand, EXPRESS is a data modelling language, which means it only defines entities and their properties, and does not define methods that might be applied to those entities in an application context.

The EXPRESS information model is organized into schemas (Figure 22). These schemas contain the mode definitions and serve as a scoping mechanism for subdividing large information models.

```

SCHEMA example;

TYPE data = ARRAY [1:3] OF INTEGER;
END_TYPE;

TYPE materialType = ENUMERATION OF (steel,
                                     stainless,bronze, Al, copper);
END_TYPE;

ENTITY thread
  ABSTRACT SUPERTYPE OF (ONEOF(male,female));
  diameter : REAL;
  pitch : REAL;
  starts : REAL;
  StartDate : date;
  material : materialType;
  DERIVE
    worktime: INTEGER := days(StartDate);
END_ENTITY;

ENTITY female SUBTYPE OF (thread);
  INVERSE
    bolt : SET [0:1] OF male FOR nut;
END_ENTITY;

ENTITY male SUBTYPE OF (thread);
  nut : OPTIONAL female;
END_ENTITY;

FUNCTION days(past : date) : INTEGER;
  (* This function calculates the number of dayss
     between the past date and the current date *)
END_FUNCTION;

END_SCHEMA;

```

Figure 22: An example of EXPRESS schema

In order to support stating complex rules, EXPRESS supports writing functions and has built-in:

- arithmetic operators and expressions (e.g. A+2)
- logical operators and expressions (e.g. A .AND. B)
- numerical functions (e.g. cos(x))
- operators on aggregates (e.g. sizeof)
- methods of describing a set of objects (e.g. all circles with radius less than 1)
- entity equality test operators

EXPRESS functions may also be used for computing values of derived attributes. Figure 22 shows an example schema taken from the EXPRESS manual, Part 11 of STEP [108]. The schema says that a thread must be a male or a female thread. Each kind of thread has diameter and pitch, number of starts, type of material, manufacturing date (start date). Work time of a thread is calculated using the days function. A male bolt has to be used with a nut, in which case the female nut has an inverse relationship to the male bolt.

Another description method (also given in Part 11) is a graphical form of EXPRESS called EXPRESS-G. An EXPRESS-G diagram shows:

- entities in solid boxes
- simple data types in solid boxes with a double line on the right end
- defined data types in boxes with dashed borders
- enumeration data types in boxes with dashed borders and a double line on the right end
- subtypes as a thick solid line connecting a supertype entity to a subtype entity with a circle at the subtype end
- required attributes as a thin solid line connecting an entity to an attribute of the entity, with a circle at the attribute end and the name of the attribute (and any aggregate description) in text next to the line
- optional attributes as a thin dashed line connecting an entity to an attribute of the entity, with a circle at the attribute end and the name of the attribute (and any aggregate description) in text next to the line and more

The EXPRESS-G diagram for the EXPRESS schema shown in Figure 22 is shown in Figure 23.

### 3.2.2. STEP Implementation Methods

The EXPRESS language does not define any implementation methods. Therefore, additional implementation methods are defined to describe STEP instances for building product exchange models, e.g. ISO 10303 AP 238 models. There are several implementation technologies available:

- A product model specific file format called Part 21 physical file [99];
- A variety of programming language bindings that allow an application programmer to open a data set and access values in its entity instances. Bindings have been developed for C, C++ and Java [109-112];
- The three methods for mapping the EXPRESS defined data into XML described by Part 28 Edition 1 [113]; and
- The XML Schema-governed representation of EXPRESS described by Part 28 Edition 2 [114].

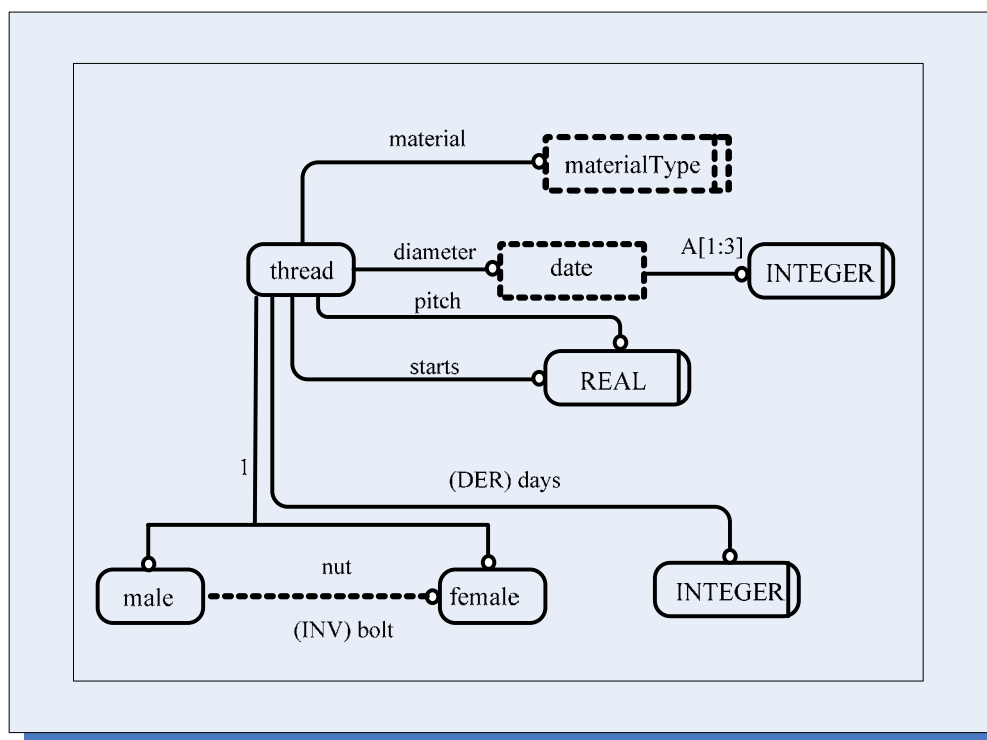

Figure 23: An example of EXPRESS-G diagram

### 3.2.3. Part 21 Physical File Implementation Method

STEP Part 21 is the first implementation method, which defines the basic rules of storing EXPRESS/STEP data in a character-based physical file. Its aim is to provide a method so that it is possible to write EXPRESS/STEP entities and transmit those entities using normal networking and communication protocols (i.e. FTP (File Transfer Protocol), e-mail and HTTP (Hyper Text Transfer Protocol)). A Part 21 file does not have any EXPRESS schemas included. It only defines the relationships between entities that are defined by

external EXPRESS schemas. The Part 21 file format uses the minimalist style that was popular before the advent of XML. In this style the same information is never written twice so that there is no possibility of any contradictions in the data. The style assumes that normally the data will only be processed by software that people will only look at the data to create test examples or to find bugs, and that making the data more easily readable by these people is less important than eliminating redundancies.

Each entity instance in a Part 21 file begins with a unique Entity ID and terminates with a semicolon “;”. The Entity ID is a hash symbol “#” followed by an integer and has to be unique within the data exchange file. The Entity ID is followed by an equal symbol (“=”) and the name of the entity that defines the instance. The names are always capitalized because EXPRESS is case insensitive. The name of the instance is then followed by the values of the attributes listed between parentheses and separated by commas.

Figure 24 shows a Part 21 file based on the EXPRESS schema shown in Figure 22. It is expected that a system that reads the file will find values for these attributes based on the data that is provided in the file. Comments in the header indicate what each header item means. The special token (“\$”) is used to represent an object whose value is not omitted. The special token (“\*”) is similar to (“\$”) except that the value can be derived from other values according to rules given in the EXPRESS schema.

#### **3.2.4. STEP Data Access Interface**

STEP Data Access Interface (SDAI) reduces the costs of managing integrated product data by making complex engineering applications portable across data implementations. Currently, four international standards have been established for SDAI,

- Standard data access interface [109];
- C++ language binding to the standard data access interface [110];
- C language binding of standard data access interface [111]; and
- Java Programming language binding to the standard data access interface with Internet/Intranet extensions [112].

```

ISO - 10303 - 21 ;
HEADER ;
FILE_DESCRIPTION      (( ' BOLT AND NUT '          ) , /* description*/
                       ' 3;1' ) ; /*implementation level*/
FILE_NAME             (' M 10 PAIR BOLT AND NUT ' , /*name */
                       '2009- 01- 09' , /*time stamp*/
                       (' D Wang' ) , /* author(s) */
                       (' UOA ' ) , /*organization(s)*/
                       'none ' , /*preprocessor version*/
                       'IIMS' , /*originating system*/
                       'noman' ); /*authorization*/
FILE_SCHEMA           ((' EXAMPLE' ));
ENDSEC ;
DATA ;
# 1 = BOLT ('10 ' , '1.5 ' , (2009 , 1 , 9) , . steel . , # 2 ) ;
# 2 = NUT ('10 ' , '1.5 ' , (2009 , 1 , 9) , . bronze . , $ ) ;
ENDSEC ;
END-ISO-10303 - 21 ;

```

**Figure 24: An example of Part 21 file**

Each standard defines a specific way of binding the EXPRESS data with a particular computer programming language. Binding is a terminology given to an algorithm for mapping constructs from the source language to the counterparts of another. Generally, the binding defined in SDAI can be classified into early and late binding.

The early binding approach generates specific data structure according to the EXPRESS schemas and the programming language definitions. The entities defined in EXPRESS schemas are converted to C++ or Java classes. The inheritance properties in the EXPRESS schemas are also preserved in those classes. On the other hand, the late binding approach does not map EXPRESS entities into classes. It uses EXPRESS entity dictionaries for accessing data. A late binding is simpler than an early binding approach because there is no need to generate the corresponding classes. However, the lack of type checking destine that the late binding approach is not suitable for large systems. A mixed binding approach may provide the advantages of an early binding (compile-time type checking and semantics as functions in a class) and late binding (simplicity). For example, a mixed binding takes advantage of the observation that applications rarely use all of the structures defined by an



AP AIM (e.g. AP 238). The subset of structures that are used, called the working set, can be early-bound, while the rest of the AP is late-bound. All data is still available, but the application development process is simplified.

### 3.2.5. XML Files

Since XML is a widely used file format and there are many software packages that will manipulate and display it, an XML file format has also been devised for representing STEP data. The main theme of the implementation method of applying XML in STEP is its two-level method. At the lower level, CAD authoring systems can continue to read and write STEP data sets. At the upper level the data sets are modularized by inserting information from the mapping tables into the XML data to explain the meaning of each entity sequence. This method is implemented using two languages, a configuration language for describing how to map EXPRESS information into an XML defined form, and the existing STEP mapping table language converted into an XML form.

### 3.2.6. Application Protocols

An application protocol is focused on a particular application domain. When the AP concept was first introduced in STEP, an AP had three parts:

- Application Activity Model - a model of the activities and data flows of the application
- Application Reference Model - a model of the data needed for a particular application
- Application Interpreted Model - an encoding of the ARM in terms of the STEP integrated resources. This is the model that is intended for implementation in systems that use STEP.

#### 3.2.6.1. Application Activity Model

The application activity model of a to-be-developed application protocol is a model of the activities and data flows of the application. AAMs are built using IDEF0, which is a graphical method of modelling activities and data flows. Activities are represented as

boxes, while data, actors, and constraints are represented by arrows. An example of the first page of an AAM is shown in Figure 25.

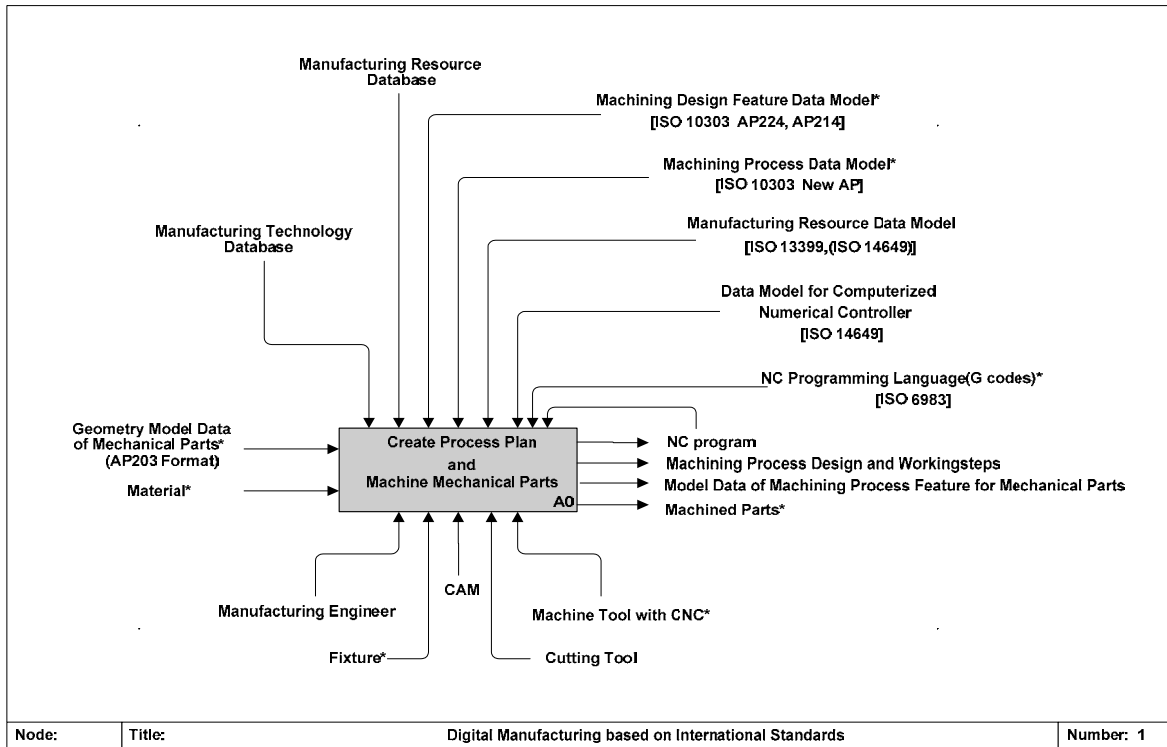

Figure 25: An AAM for digital manufacturing [21]

In the IDEF0 approach, an aggregated model is built first to show the big picture with three to six activities. Then one or two rounds of refinement are performed, with each activity at an upper level being expanded into an entire page at the next level down. Once the AAM stage is completed and an ARM has been built, the AAM plays no further role.

### 3.2.6.2. Application Reference Model

The application reference model of an application protocol is a model of the data needed for a particular application. The model is given using the terminology of the application so that the model can be understood by practitioners of the application (who are involved in the development of the model). The process of building an ARM usually includes workshops at which domain experts decide what entities should be defined and what their attributes should be. ARMs may be written in EXPRESS, EXPRESS-G, or IDEF1X. The modelling language is less important than the content.

### ***3.2.6.3. Application Interpreted Model***

The application interpreted model of an application protocol is an EXPRESS model of (exactly) the information in an ARM but encoded in terms of the STEP integrated resources. The encoding is done using mapping tables, the format of which is formally defined and is uniform across STEP. The cardinal example of this is STEP AP 203. For most APs, however, the encoding is mostly done using entities from Part. The AIM that results from the encoding is usually very verbose and unintelligible. And it can only be done by a STEP expert.

### ***3.2.6.4. Other Documentation Strategies of AP***

The following documentation strategies have been added in order to modularize APs.

- Unit Of Functionality

A UOF is a subset of the ARM of an AP containing entities and related constructs that support some specific functionality. A number of APs were produced containing explicit UOFs.

- Application Interpreted Construct (AIC)

An AIC is a UOF reinterpreted in terms of the STEP integrated resources. The idea is that an AIC developed for use in the AIM of one AP can be reused in other APs.

- Application Module

As mentioned earlier, the UOF/AIC method of modularizing an AP was found to be inadequate to support reuse and is being replaced by the AM method described next. Like an AP, an AM has an ARM written in terms of the domain being modelled.

### 3.2.7. STEP Integrated Resources

STEP integrated resources are a collection of EXPRESS models. They provide a fixed set of entities whose instances are allowed to occur in the files and databases that are intended for application. They include three types of models:

- STEP integrated generic resources - EXPRESS models for basic capabilities of product data representation.
- STEP integrated application resources - EXPRESS models for more specific but widely applicable types of product data, such as draughting (Part 101)[115], kinematics (Part 105) [116], and finite element analysis (Part 107) [117].

Generic resources from other ISO standards - EXPRESS models for basic capabilities of product data representation that were developed for other ISO standards and adopted by STEP.

### 3.3. STEP-NC

As mentioned above, STEP-NC is being developed to provide a data model for a new breed of intelligent CNC controllers. The ARM of STEP-NC, i.e. ISO 14649 is made up of several Parts. The general title for STEP-NC is Data Model for Computerized Numerical Controllers representing a common standard specifically aimed at NC programming, making the goal of a standardised CNC controller and NC code generation facility a reality. In 2004, the first set of Parts of ISO 14649 became international standards. Several Parts of ISO 14649 were also adopted as conceptual models by the ISO team developing AIM of STEP-NC, i.e. ISO 10303-238 (or STEP AP 238) in the early 2000s, and AP 238 was published in 2007. Development of both ISO 14649 and STEP Part 238 continues today. Both of them are commonly known as “STEP-NC”.

ISO TC 184/SC4, Industrial data, is developing ISO 10303-238, using the EXPRESS models in ISO 14649 as the domain requirements model (e.g., ARM) with a few modifications. The model is then mapped to the STEP integrated resources to obtain an implementation model. A set of ISO 14649 construct the STEP-NC standards are listed as follows:

- ISO 14649-1: Overview and fundamental principles [21];
- ISO 14649-10: General process data [118];
- ISO 14649-11: Process data for milling [119];
- ISO 14649-12: Process data for turning [120];
- ISO 14649-111: Tools for milling [121];
- ISO 14649-121: Tools for turning [122];

These Parts are arranged hierarchically, in that Part 11 uses Part 10 and Part 111, while Part 12 uses Part 10 and Part 121. Part 10 provides a set of basic capabilities for process planning for machined parts. Parts 11 and 12 specialise these capabilities for milling and turning, respectively (Figure 26).

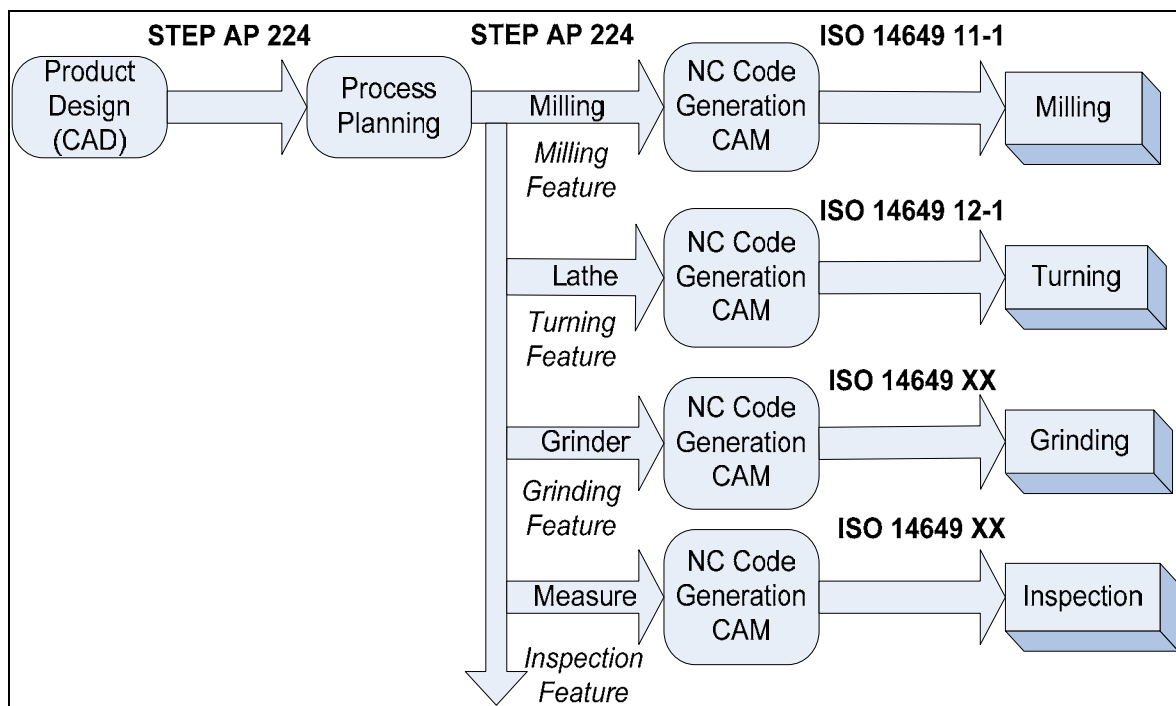

**Figure 26: Design – manufacturing chain enabled by STEP-NC**

ISO TC 184/SC1 has the intent that STEP data representation methods be used with ISO 14649, since the Parts of ISO 14649 that include examples use STEP Part 21 files for them. File exchange for industrial use can be accomplished quite well using Part 21 files based on ARM type models. ISO 14649 is a thought of as modelling information for process planning at the micro-level, hence the intention of replacing G-code, which is traditionally

and still extensively used to program NC machine tools. It is therefore worth mentioning ISO 10303-240 Process plans for machined products [123], which can model process planning information at the macro-level.

Comparing STEP-NC with G-code, there are many benefits (Figure 27) [124, 125]

- STEP-NC provides a complete and structured data model, linked with geometrical and technological information, so that no information is lost between the different stages of the product development process.
- Its data elements are adequate enough to describe task-oriented NC data.
- The data model is extendable to further technologies and scalable (with Conformance Classes) to match the abilities of a specific CAM, SFP (Shop Floor Programming) or NC systems.
- Machining time for small to medium sized job lots can be reduced because intelligent optimization can be built into the STEP-NC controllers.
- Post-processor mechanism will be eliminated, as the interface does not require machine-specific information.
- Machine tools are safer and more adaptable because STEP-NC is independent from machine tool vendors.
- Modification at the shop-floor can be saved and fed back to the design department hence bi-directional information flow from CAD/CAM to CNC machines can be achieved.

### 3.3.1. Information Content and Structure

Effectively, STEP-NC defines a data input standard for CNC systems. As STEP-NC is an extension of STEP to handling NC processes, it strictly follows the STEP standard. Like other STEP applications, STEP-NC files also conform to ISO 10303-21. That is, the file contains two sections marked by the keywords HEADER and DATA respectively (Figure 28). In the HEADER section, some general information and comments concerning the part program are included. These are, for example, filename, author, date and organization.

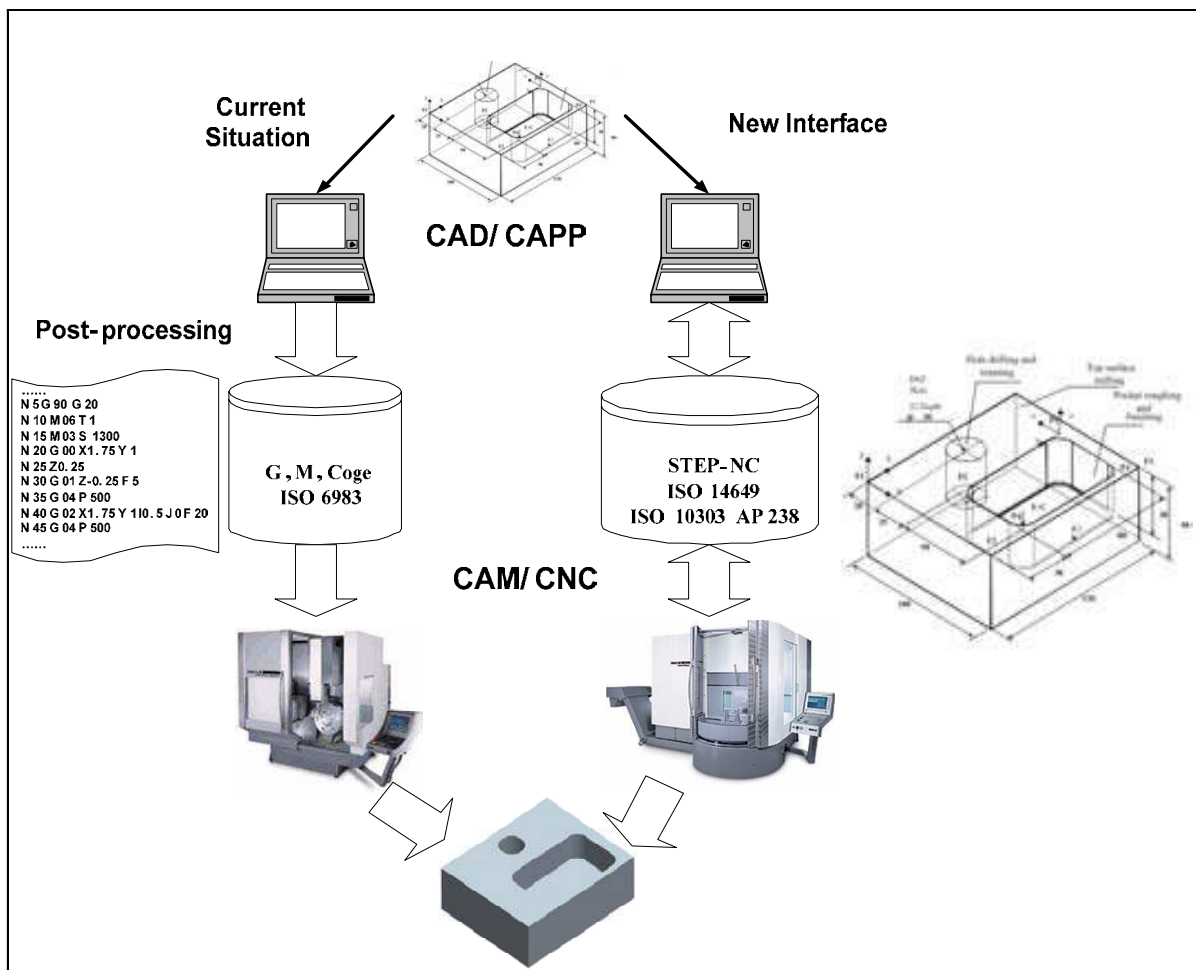

**Figure 27: Comparison of G&M code and STEP-NC data**

The DATA section is the main part of the program, containing all the information about manufacturing tasks and geometry. This section also includes a PROJECT entity that is an explicit reference for the starting point of the manufacturing tasks. The PROJECT entity contains a main “Workplan” that contains sequenced executable manufacturing tasks called “Workingsteps”. Therefore, a STEP-NC file has an object oriented data structure.

Executable objects initiate actions on a machine and are arranged in a pre-defined but changeable order. There are three types of executable objects: NC\_function, program\_structure and Workingstep. NC functions describe switching operations and other non-interpolating machine functionality, typically singular events. Program structures are used to build logical blocks for manufacturing operations while Workingsteps are the basic units used for the manufacture of features.

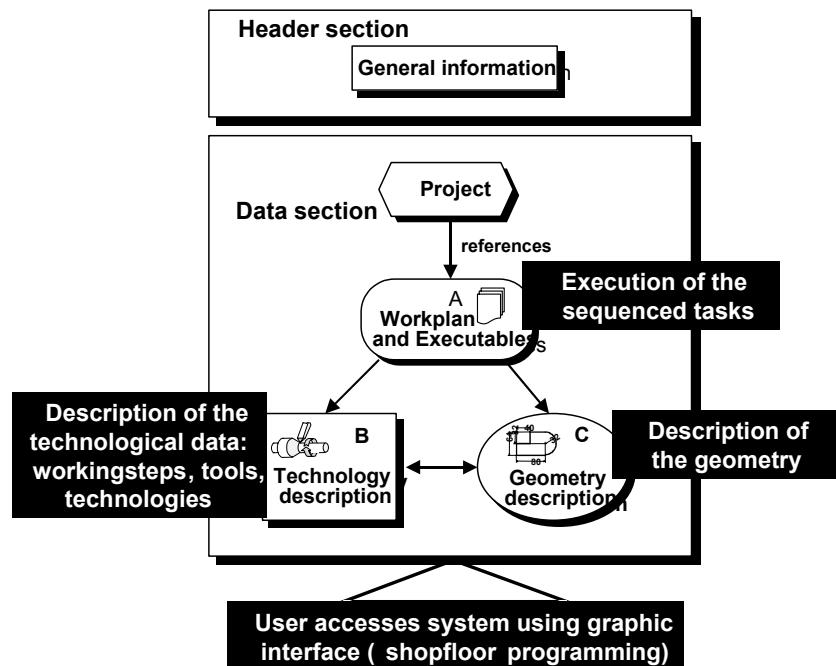

Figure 28: Structure of the STEP-NC data model [21]

In essence, STEP-NC describes “what to do”, while G-code describes “how to do”. STEP-NC describes tasks (pre-drilling, drilling, roughing, finishing...) that are based on the machining features, so that the part program supplies the shop-floor with higher-level information, i.e. the information about machining tasks and technological data on top of pure geometrical and topological information. As a result, modifications at the shop-floor can be saved and transferred back to the planning department that enables a better exchange and preservation of experience and knowledge.

Details of each Workingstep are given in two parts, Technology description and Geometry description. The Technology description contains a detailed and complete definition of all Workingsteps in a Workplan. This may include tool data (dimensions, tool type, conditions and usage of the tool), machine functions, machining strategies, other process data and a workpiece definition (surfaces, regions and features of the finished part). The Geometry description, which is of ISO 10303 data format, provides the geometrical information for workpieces, set-ups and manufacturing features. At the lowest level, the operations can also contain an explicit and exact description of the tool-path if this is required by a CAM system or an NC controller. The hierarchy of a STEP-NC program can be depicted by the diagram shown in Figure 29.



A `Machining_Workingstep` is the subtype of the `Workingstep` that is a subtype of executable. It is the only executable unit to process a part, namely to trigger the axis movements and get material removed during CNC execution. However, it contains not only information required to machine but also the links to information of the machining technologies and geometric semantics. The execution sequence of the NC program is determined using the entity `Workplan` that has an ordered set of the Executables.

A `Manufacturing_feature` covers most of the manufacturing features defined in STEP AP 224 and has geometric information. For example, a `Closed_pocket`, one of `Manufacturing_features`, has a boundary curve data and depth of bottom if it has a planar bottom condition.

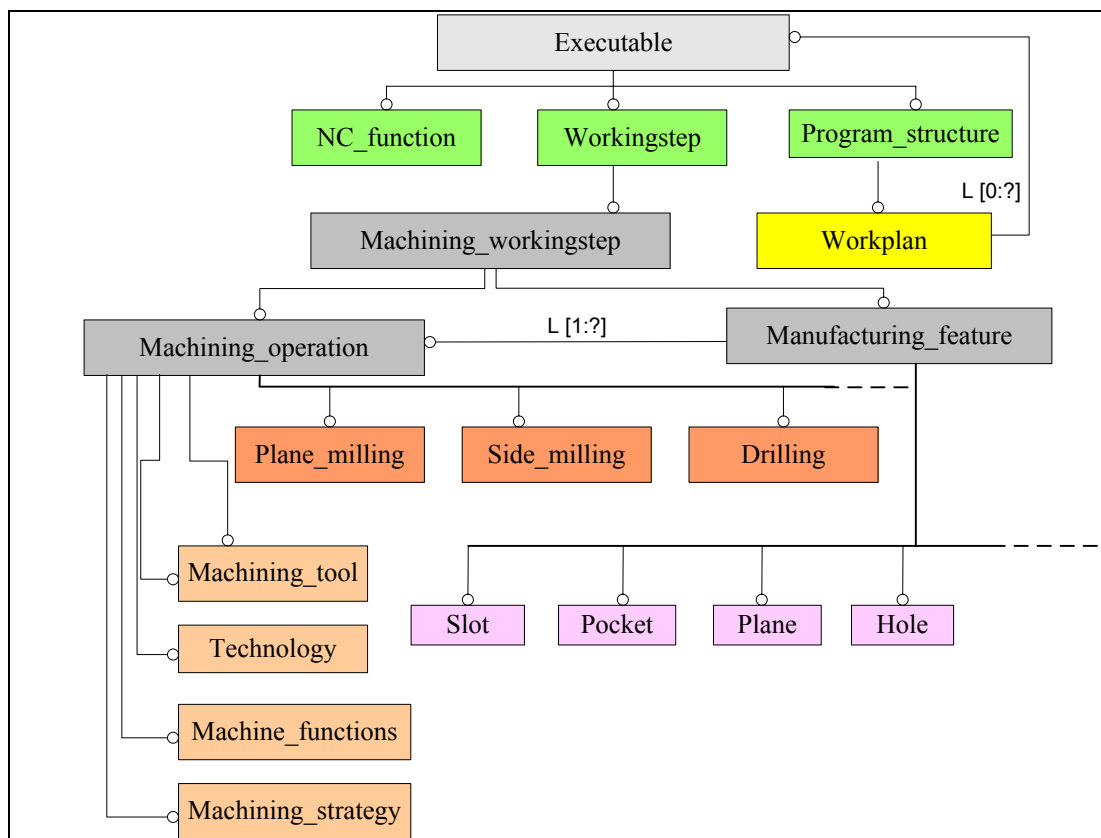

**Figure 29: Structure of a STEP-NC program**

A `Machining_operation` is the abstract base class for the process specific operations. It specifies the tool to be used (`Machining_tool`), and a set of technological parameters:

machining parameters (Technology, e.g. feed-rate, spindle speed), machining conditions (Machine\_functions), and Machining\_strategy (e.g. contour parallel, contour spiral).

### 3.3.2. ARM vs. AIM in STEP-NC

Much has been discussed and argued about ARM and AIM of STEP-NC, mainly because they are being worked on by two different ISO subcommittees. ISO TC 184/SC1 works on ISO 14649, the STEP-NC Application Reference Model, which focuses on describing functions of a CNC controller. ISO TC 184/SC4 on the other hand works on STEP AP 238, the STEP-NC Application Interpreted Model, which focuses on the integration of STEP and STEP-NC. The main difference between ARM and AIM models is the degree to which they use the STEP representation methods and technical architecture.

ISO 14649 is free of the STEP design data, or strictly speaking it was developed with an intention not to include the complete design data. The absence of design information makes the bi-directional data flow between design and manufacturing impossible. As a part of the STEP standard, STEP AP 238 inherits all the information from STEP AP 203 and AP 224 plus an interpreted model mapped from ISO 14649. Hence, bi-directional data exchange can be supported. Figure 30 portrays the relationship between ISO 14649 and some APs of STEP ISO 10303. STEP AP 238 though also has its shortcomings. As an Integrated Resource file, it needs to cover all the relevant information, which inflates the file size as well as complicated the data access tasks.

ISO 14649 and ISO 10303-238 can be viewed as two different implementation methods of the STEP-NC standard. The ISO 14649 standard is more likely to be used in an environment in which CAM systems have exact information from the shop floor; whereas STEP AP 238, as a part of the STEP standard, is more suitable for a complete design and manufacturing integration.

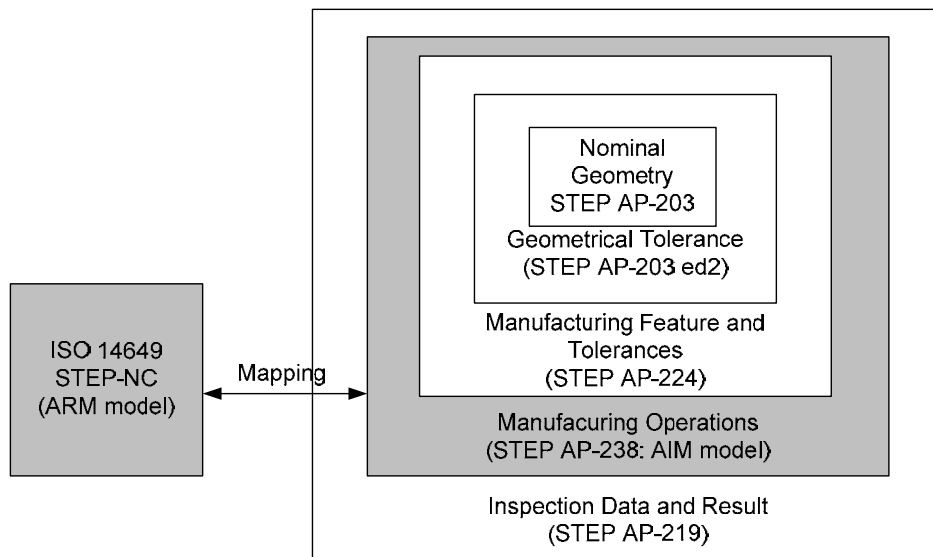

**Figure 30: Relationships between ISO 14649 and STEP APs [126]**

### 3.4. Recap

In the past years, users and vendors have been seeking a common language and/or data model for CAD, CAPP (Computer-aided Process Planning), CAM and CNC, which can integrate and translate the data and knowledge of a product with no data loss. Though there are many CAD/CAM tools supporting NC manufacturing, lack of data portability and interoperability is still one of the key issues in limiting a wider use of these tools.

A primary goal of STEP is to facilitate interoperability among implementations of different STEP application protocols. This is accomplished through consistent mapping of similar requirements to the generic building block data structures in the integrated resources. In STEP, the implementation can leverage data that is available in other STEP AP formats due to the effort made to integrate and harmonize STEP APs. Integration is another benefit of STEP that offsets the cost of the additional lines of code and size of data files. The combinations of implementation methods and application protocols defined in STEP and STEP-NC standards provide standardized physical file formats and data access interfaces for those physical file formats that can cover all the aspects of design and manufacturing activities. Hence, the former proprietary format, G-code can be replaced by a unified data model within the scope of STEP. The data exchanges between different systems no longer have barriers. It has been predicted that STEP and STEP-NC will reduce the time required

to program a CNC by 35%, reduce the number of drawings that have to be sent from design to manufacturing by 75% and decrease the time required to machine parts on CNC tools by 50% by enabling faster machines to be used for small to medium-size job lots [86].

STEP-NC comes with many other benefits. Its Workingstep-based mechanism replaces the controller's axis motion and tool operation command sets in G-code. By using Workingstep as the basic entity, STEP-NC expands a set of related entity such as machining features, cutting tools and tolerance according to STEP Part 21 definition. The high-level information provided by STEP-NC makes CNC programs more readable and modifiable; it also enables bi-directional data flow between CNC machines and CAM systems (or even CAD systems).

Because of these technical advantages and benefits in STEP and STEP-NC, the research work reported in this thesis utilises both STEP and STEP-NC as the underpinning product and manufacturing models. Considering the strength of ISO 14649 (e.g. simple data structure and adequate manufacturing data), STEP-NC ARM is used for NC data modelling purposes.

# *Chapter 4 Proposed STEP Data Model*

It is identified in Chapter 2 that a consolidated data model is essential for achieving integrated machining and in-process measurement for CLM. STEP/STEP-NC is by far the most comprehensive data model for product related information and is therefore chosen in this research to be the foundation for the development of a consolidated data model for the proposed system. This chapter first presents an overview of STEP/STEP-NC related research on CAIPP systems and standard development. This is followed by a detailed description of the proposed STEP data model, which consists of (a) harmonized definitions from the existing STEP/STEP-NC Parts, (b) newly defined in-process measurement operation information, and (c) newly defined mechanism to link machining feature information with GD&T requirements.

The major part of this chapter has been reported in one published journal paper [3] and one journal paper *in-press* [5].

## **4.1. STEP/STEP-NC Related Research on CAIPP and Standard Development**

STEP/STEP-NC is relatively new. Very limited research has been carried out on developing STEP/STEP-NC compliant CAIPP systems, most of which started after the mid 1990s. Among the reviewed research, CMMs were mostly chosen to carry out measurement operations.

Multiple STEP/STEP-NC APs and Parts have definitions related to inspection process and operations. However, these standards overlap with each other and are still incomplete in supporting CAIPP. The international metrology communities and STEP/STEP-NC

standards committees are aware of these problems and are addressing some emerging issues through a series of meetings.

#### 4.1.1. Overview of STEP/STEP-NC Related CAIPP Research

Lin and Chow [127] integrated a STEP data module with an IDEF0 model for CMM-based inspection process planning. The EXPRESS data module of STEP was used in this research to provide an object-oriented measuring information flow to increase the efficiency of system designers in developing a measuring system.

The U. S. National Institute of Standards and Technology [125, 128] proposed a Feature-Based Inspection and Control System (FBICS) for machining and inspecting mechanical piece parts. FBICS controls a machining centre or a CMM for inspection. It uses a feature-based description of the shape of the object to be made or measured as the principal input for machining and/or inspection. ISO 10303 AP 224 predefined machining features are used for defining an inspection node in the process plan. DMIS is used to control the CMM. For each AP 224 feature type, corresponding DMIS features are defined to represent the AP 224 feature for inspection operation; and then, measurement commands are generated in DMIS. The characteristics of FBICS are a tightly integrated open architecture, hierarchical tasks and control, standard data representation with clearly defined modules, command interface and data interfaces.

Brecher, *et al.* [129] in the Laboratory for Machine Tools and Production Engineering (WZL) at Aachen University in Germany, developed a system for a closed-loop process chain which intergraded inspections into the STEP-NC machining information flow. The research presents a system that supports milling and CMM-employed inspection operations for feature-based, closed-loop machining. A prototype implementation (Figure 31) was carried out for the proposed system. Two STEP-NC-based controllers were used for the implementation: (1) Sinumerik 840D+STEP-NC enabled ShopMill controlling of a Chiron machine tool, and (2) a WZL-NC controlled Maho 600E machine tool. The milling operations are defined in an ISO 14649 data file including inspection workingsteps. The data file is processed by the WZL-SFP program, which provided graphics of the workpiece and manual tolerance and inspection workingstep definition input. Hence, machining

commands for the aforementioned machine tools are generated for machining and inspection commands are generated for CMM (Zeiss CMM with Calypso software in this implementation) to carry out inspection operations. Inspection results are stored in a text file, which is then parsed and reintegrated into the STEP-NC data file to provide feedback information.

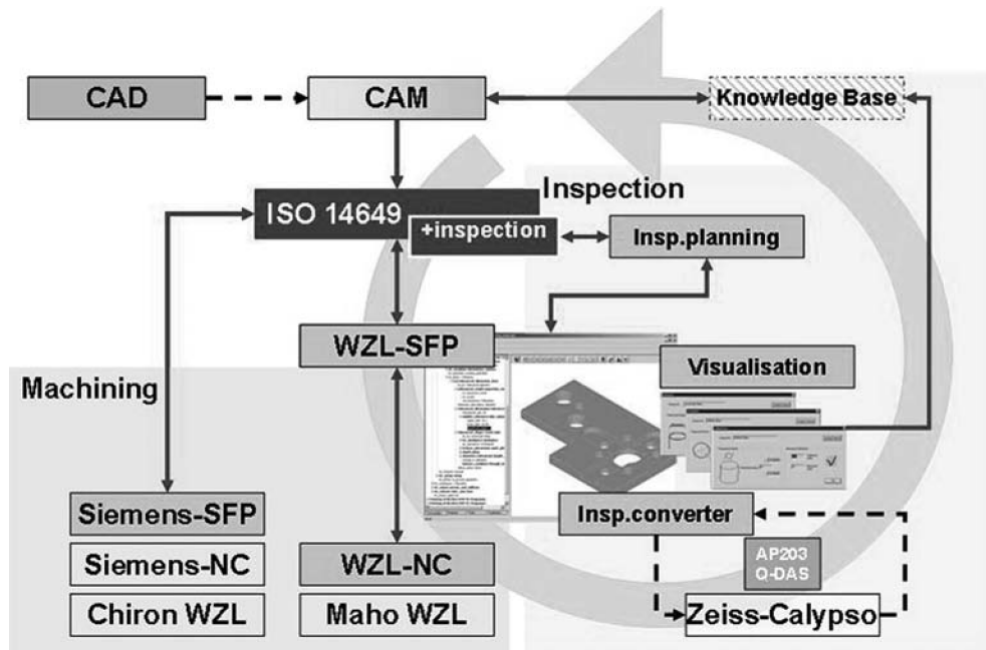

Figure 31: Prototype implementation of the STEP-NC enabled CLM [129]

Suh *et al.* [130] at the Pohang University of Science and Technology in Korea, presented a method of indirect measurement based on the Virtual Gears Model (VGM), obtained by NURBS fitting of the surface points measured by a CMM. By comparing the VGM with CAD model (soft-master model), various errors such as tooth profile error and tooth trace error were automatically measured. The model-based method can be incorporated in an advanced CNC controller based on the new CAM–CNC interface scheme of STEP-NC as an on-line inspection module.

In the United States, NIST, Boeing, General Electric, Unigraphics and some other industry partners collaborated on a STEP-enabled CLM scenario including probing activities using ISO 10303 AP 238. Two of the three probing operations defined in ISO 14649 Part 10 were tested in this demonstration (workpiece\_probing and workpiece\_complete\_probing).

The workpiece was measured on a CMM machine. The inspection results were fed back to the original input (AP 238) data file for necessary modification. Then, the modified AP 238 data was tested. Due to possible CNC machine axis misalignment, offsets were coupled. This demonstration was the first attempt to test the inspection operation definitions in the existing ISO 14649 standards.

Ali, *et al.* [131] developed an inspection framework for closing the inspection loop through integration of information across the CAx process chain. The proposed STEP-compliant inspection framework works with an inspection workplan, workingstep, and a mechanism to feed back inspection results across the total CAx process chain. STEP-NC (ISO 14649-16), DMIS and ISO 10303 AP 219 (application protocol for dimensional inspection information exchange for CMMs) [94] were used as the basis for representing the product and manufacturing models. This research mainly focused on utilising a CMM.

ISO committees and major inspection related research groups have been holding joint meetings in the effort to further develop and harmonize existing inspection standards such as DMIS, AP 219, and ISO 14649 Part 16 [132] (data for touch probing based inspection for CMMs). In 2006, the AIAG's MEPT team started to explore STEP-NC enabled solutions in conjunction with the work on DML and the new Quality Measurement Data (QMD) standard at the ISO TC184/SC4 WG3-T24 STEP-Manufacturing Hershey meeting, US. At this meeting, Airbus presented its requirements for tolerances in next generation CNC machining. Boeing presented a test result of using AP 203 edition 2 for CLM machining process. During the meeting, it became clear that the several standards/specifications under the oversight of the MEPT, namely, I++ DME, DMIS, DML, QMD, and Scan Data, should generally fit well within the context of the appropriate STEP APs.

In 2007, a STEP-enabled on-machine inspection demonstration was carried out at a STEP meeting in Ibusuki, Japan. At attendance were NIST, STEP Tools Inc., Boeing, Airbus, and other major industry companies. An on-machine inspection operation was carried out on a fish-head shaped workpiece (provided by Airbus). Although inspection path planning and measurement points optimization were not considered in this demonstration, it was the first physical demonstration of STEP-enabled on-machine inspection. At the same meeting,



a High-level Inspection Planning (HIPP) system was proposed for conducting STEP-enabled inspection tasks. A new edition of AP 238 was also proposed with new inspection feature definitions and changes to some related existing entities.

#### 4.1.2. CAIPP Related STEP/STEP-NC Standard Development

The ISO, AIAG, and MEPT metrology standard development groups have joined to address the gaps and overlaps between different inspection data models through a harmonized STEP inspection data model. The incompleteness of the inspection-based STEP data model has been realized and the need to harmonize STEP/STEP-NC with some widely used and emerging interface specifications such as DMIS and I++ DME has been recognized. Both ISO 14649 Part 16 and ISO 10303 AP 219 are incomplete and undergoing changes. ISO 14649 Part 16 does not have the definition of inspection features and geometric tolerances, whereas ISO 10303 AP 219 does not specify the inspection operations and strategies for corresponding inspection features. Both of these standards support only inspection operations carried out on CMMs. Hence, these standards lack definitions of measurement machine functions and technologies, metrology device information, and measurement strategy information. Most of this information is defined in other standards such as DMIS and I++DME. Therefore, the challenges for inspection data model development for Part 16 and AP 219 is to harmonize and integrate these definitions to support different types of inspection operations.

The latest joint meeting across these committees was the 53<sup>rd</sup> ISO TC184/SC4 meeting in Dallas, USA, 2007. NIST proposed a newly developed AP 238 ARM model for the HIPP system proposed at the Ibusuki meeting. The ARM model combined the information requirement models for machining defined by ISO 14649 Parts 10, 11, 12, 111, and 121. The ARM model was also augmented with product data management information and information necessary to harmonize the inspection feature descriptions with the STEP manufacturing application protocols and link to the aforementioned data. The data model is still under development.

Figure 32 summarizes the recent research on STEP/STEP-NC enabled CAIPP systems and the standard development focus each research community has. The horizontal axis in the

figure represents the research from 2003 till now. The first draft of ISO 14649 Part 16 was established in early 2003. The first implementation of STEP-based inspection operation was carried out in 2005, and the first implementation based on ISO 14649 Part 16 was in 2006. The vertical axis in the figure represents the functional requirements, which consist of data model, macro planning, micro planning, execution, and feedback.

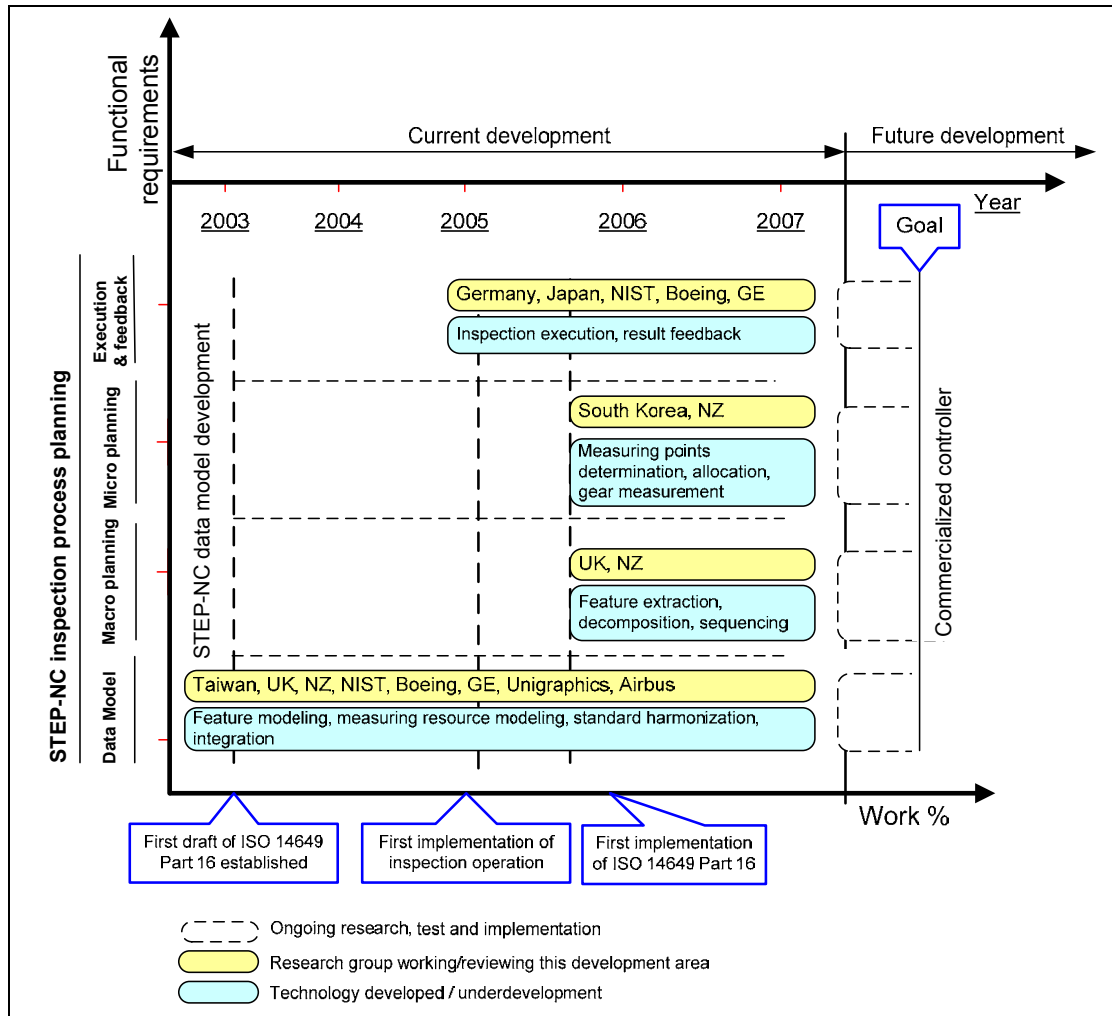

Figure 32: Research on STEP/STEP-NC enabled inspection systems (2001-2008)

The aforementioned implementations were mostly based on CMM inspection operations, and the purposes of these implementations are to test the feasibility of the existing data models for inspection rather than testing for conformance. Some new data models have been proposed. However, they are still incomplete and need to be developed in support of different types of inspection systems.

## **4.2. Proposed STEP ARM Data Model for Integrated CNC Machining and Inspection**

The objective of the proposed integrated process planning system is to combine machining and inspection process planning, hence to generate optimal machining and in-process measurement operation sequence and provide real-time feedback to process planning. The first step of developing a consolidated and complete data model for the integrated process planning system is to identify what information should be defined in the data model.

As introduced in Section 3.2.6.1, the development of each STEP AP starts with developing the AAM model to identify the activities and information flow in the AP. Then, the identified information is defined into the ARM data model for the AP. This research follows these two steps to develop the STEP Application Protocol ARM data model for integrated CNC machining and inspection for the proposed process planning system.

### **4.2.1. AAM Model of Integrated Machining and In-process Measurement Process Planning System**

The input to the whole process planning system (Figure 33) includes the design data (GD&T, geometry, etc.), the raw part, and criticality weighting information. The integrated machining and in-process measurement process planning system is based on the input and related knowledge from the dimensional measurement resource database, the measurement database, the machine tool database, and the process compensation database. It makes decisions in generating machining and in-process measurement operation commands. After each measurement operation, the results are collected and analysed. The update information for the subsequent machining operations is fed back. The measurement results and update information can be stored for long-term machining process analysis and evaluation.

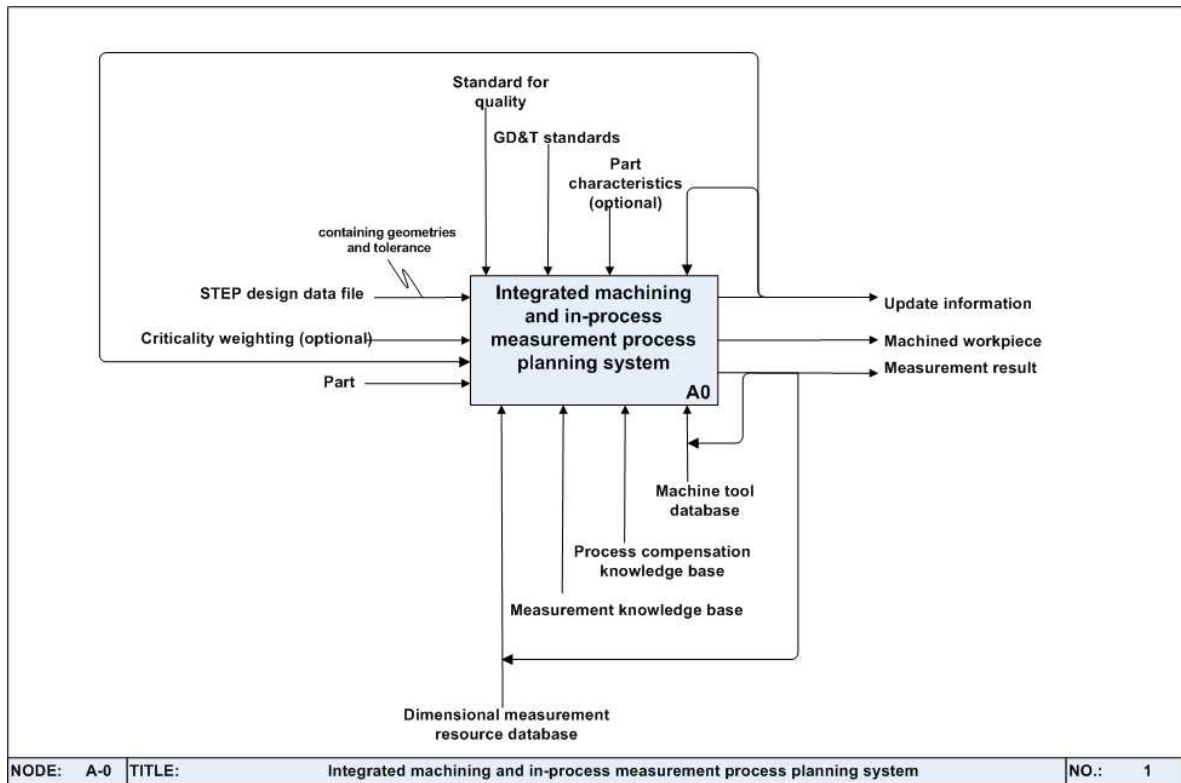

**Figure 33: A0 level AAM model for the integrated process planning system**

The entire process planning system can be divided into two sub-systems (Figure 34): the integrated machining and in-process measurement process planning system (A1 activity) and the machining and in-process measurement execution and analysis system (A2 activity). The former is in charge of generating optimal machining and in-process measurement operation sequence and their commands, which are passed on to the latter sub-system. The machining and in-process measurement execution and analysis system generates the machining and measurement commands, collects measurement data, and generates updates based on the analysis of the measurement results.

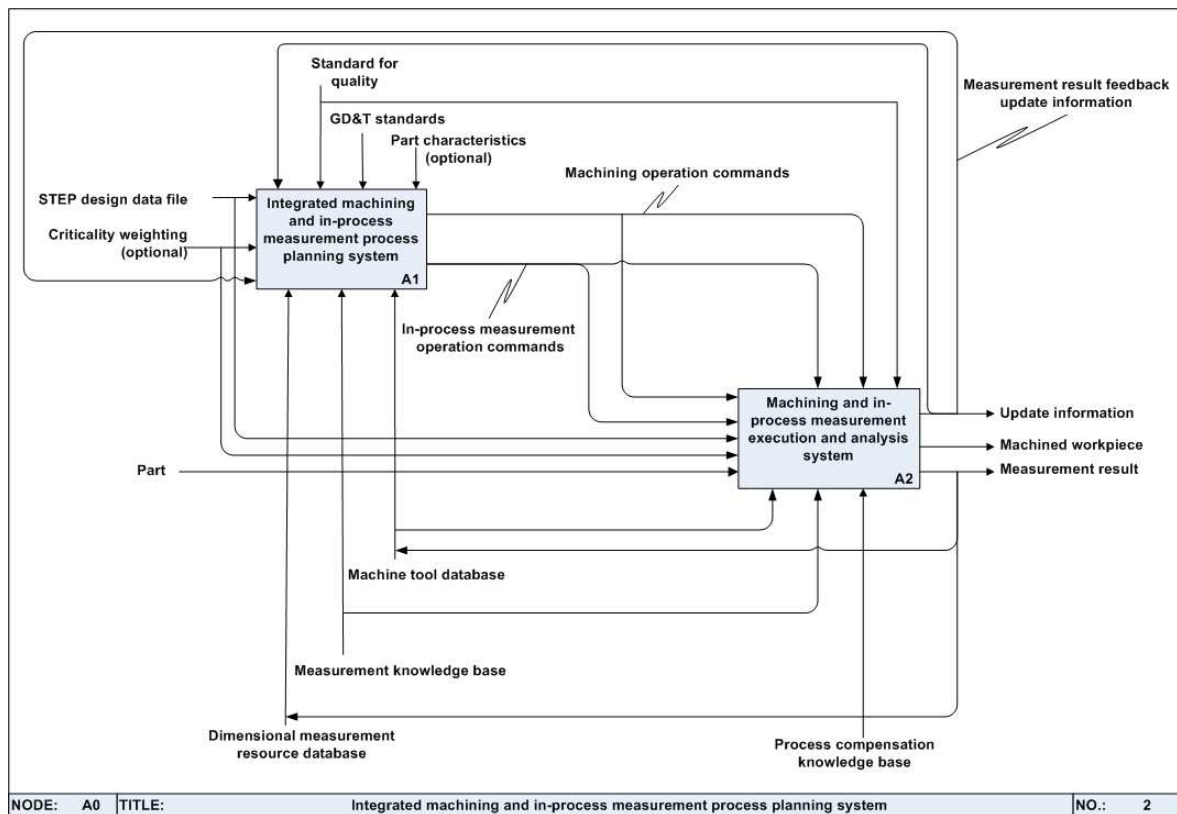

**Figure 34: A0 activities in the integrated process planning AAM model**

The A1 sub-system is further divided into three sub-systems (Figure 35): the macro process planning system (A11 activity), the micro measurement operation system (A12 activity), and the micro machining operation system (A13 activity). The macro process planning system (Figure 36) analyses STEP design data, selects/creates measurement features for each measurement operations, and sequences machining and in-process measurement operation. Each measurement and machining operation is further planned through the micro measurement and machining process planning system to generate required commands. Since research on machining process planning is quite mature, this research focuses on developing the micro measurement process planning system, which is further divided into six sub-systems (Figure 37).

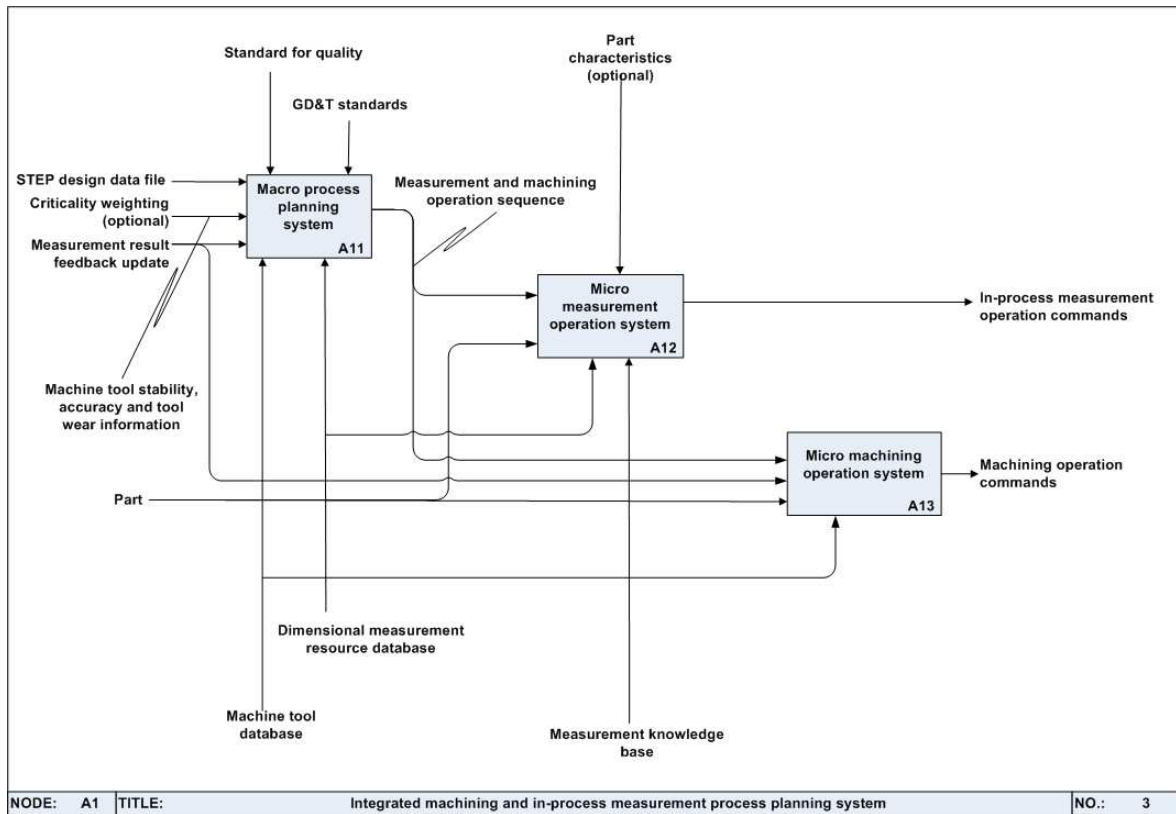
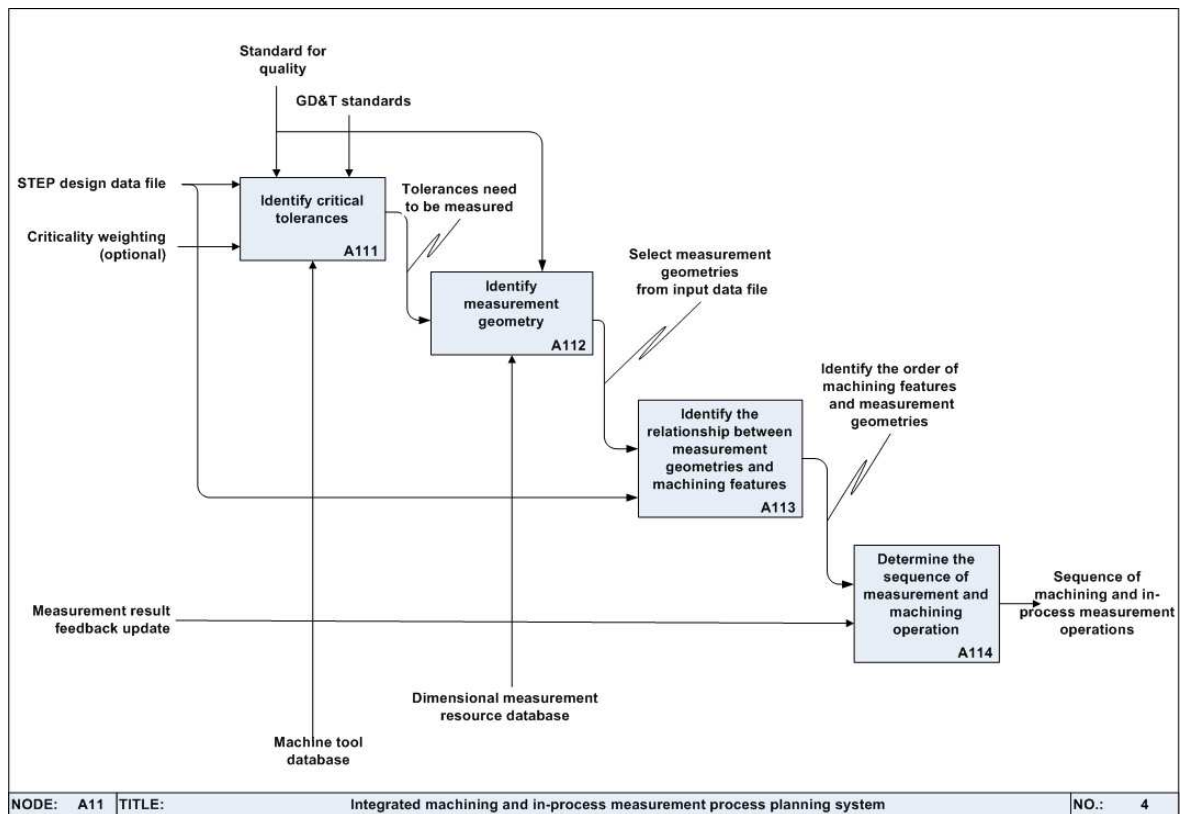

Figure 35: A1 activities in the integrated process planning AAM model

Figure 36 shows the activities within the macro process planning system (A11 activity). It consists of four activities. The design information and criticality weighting requirements are first processed to select critical tolerance requirements on the part (A111 activity). These tolerance requirements are used to identify measurement geometry that should be measured in-between machining operations (A112 activity). In order to sequence machining and in-process measurement properly, it is necessary to first identify the relationship between the measurement geometry and machining operations (A113 activity), then the sequence of the measurement and machining operation can be decided (A114 activity).



**Figure 36: A11 activities in the integrated process planning AAM model**

The measurement and machining operation sequence is passed from A11 activity to A12 and A13 activities, respectively. Figure 37 displays the six sub-activities within A12 activity. To carry out each measurement operation, measurement devices need to be decided first (A121 activity). Then, the number (A122 activity) and the allocation (A123 activity) of measurement points can be decided for each measurement geometry. This is followed by feature interaction detection and measurement points reallocation activity (A124) which detects any possible interaction between measurement geometry and other machining features. The measurement points are checked and reallocated to solid surfaces. After that, the probing path is generated in A125 activity. The final activity is to check whether the current measurement geometry is the last one within in this measurement operation (A126 activity). This loop continues until all measurement geometry is processed.

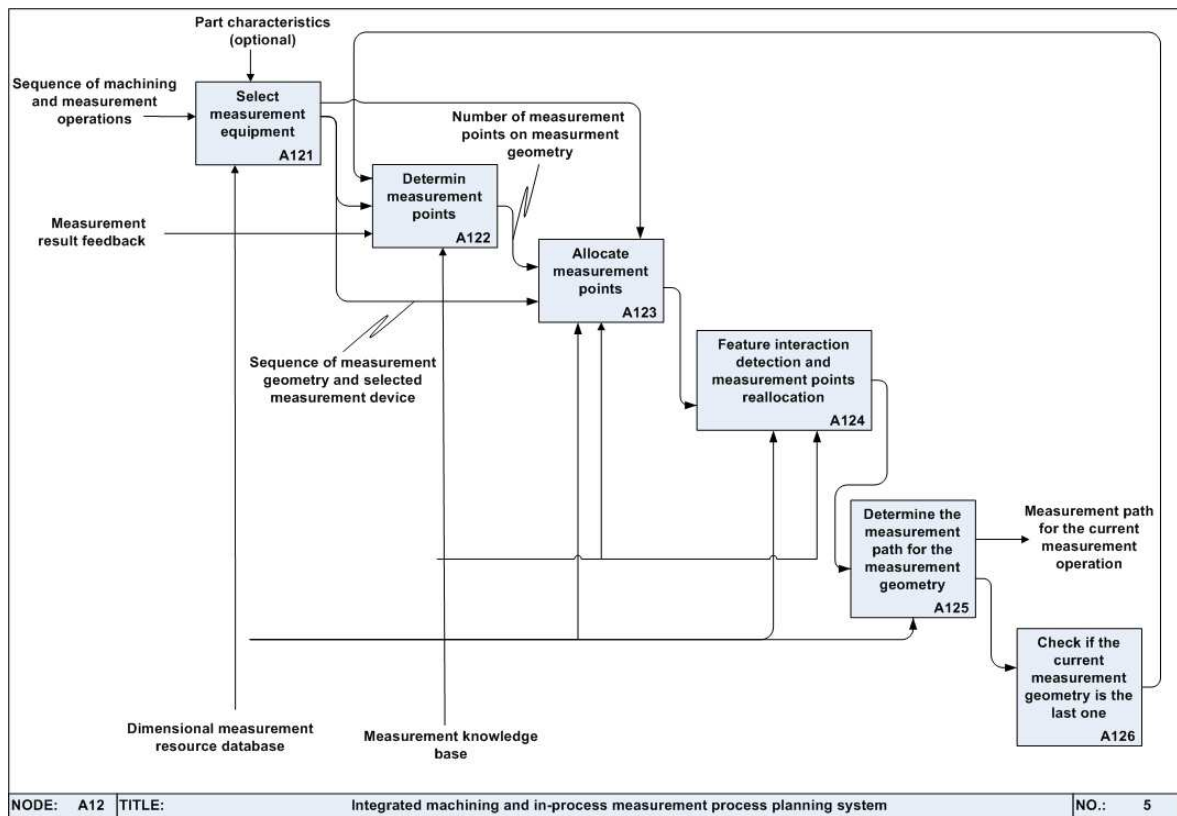
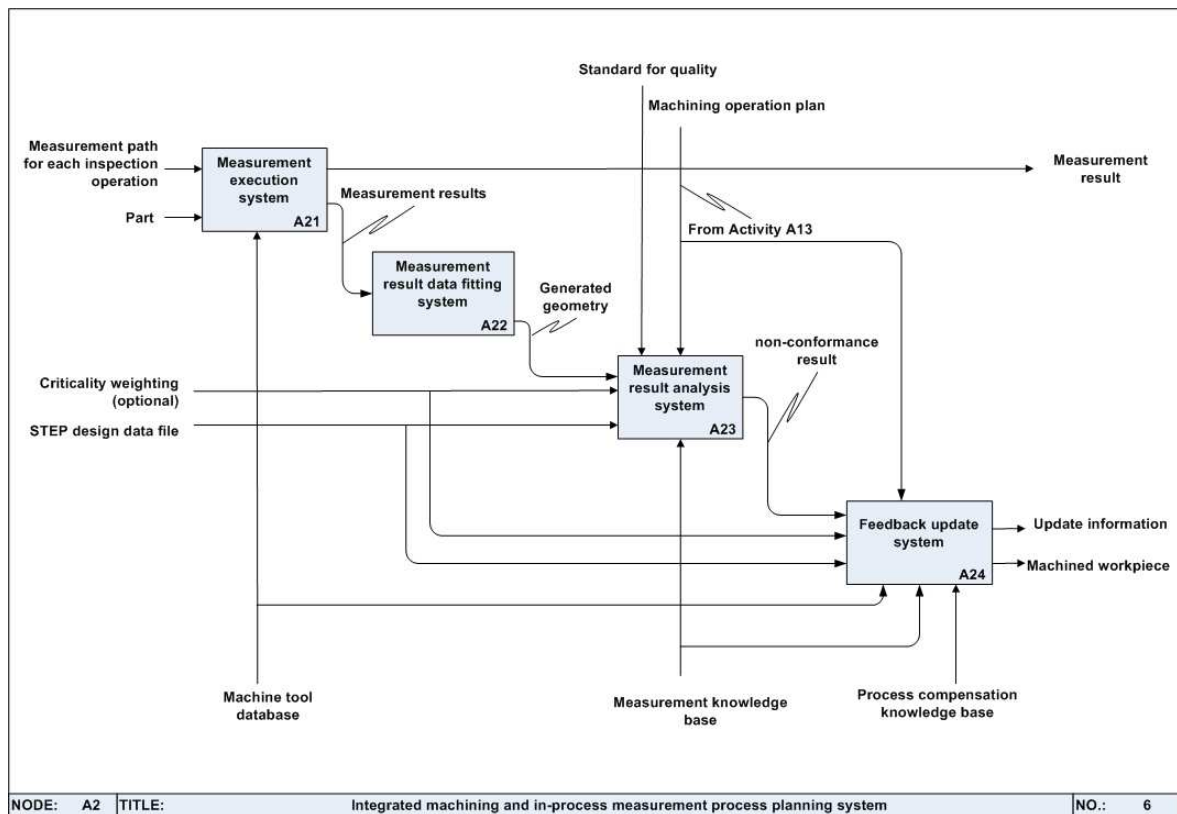

Figure 37: A12 activities in the integrated process planning AAM model

Measurement probing path information from A12 activity is then passed to A2 activity for execution and analysis. A2 activity has four sub-systems (Figure 38). The first sub-system is the measurement execution system (A21 activity) which generates measurement commands according to the selected measurement device. Then, measurement results are collected by the measurement result data fitting system (A22 activity), which employs data fitting algorithms to generate measured geometry. This measured geometry is then compared with the input design data in the measurement result analysis system (A23 activity). Necessary update is passed on to appropriate machining operations in the feedback update system (A24 activity). After all machining and in-process measurement operations are executed, the finish workpiece is produced.





**Figure 38: A2 activities in the integrated process planning AAM model**

#### 4.2.2. Proposed STEP Application Protocol ARM Data Model for Integrated CNC Machining and Inspection

Through the development of AAM model in the above section, the information that the consolidated data model must provide is summarized as follows.

- Product data management information

This information includes product approval, security classification, modification, and timestamp related information.

- Machining related information

Machining related information includes machining features, operations, machine tools, and other machining process related general process information.

➤ Inspection related information

Inspection related information includes GD&T requirements, inspection features, operations, measurement devices, measurement results, and inspection process related general process information.

The development of the proposed data model underwent three stages: investigating existing STEP/STEP-NC standards, identifying and harmonizing already defined information from STEP/STEP-NC Parts and APs, and augmenting the data model with newly defined information. In Chapter 3, it is introduced that within the current STEP/STEP-NC standards, machining feature, machine cutting tool related information, and general process data are defined in ISO 14649 Parts 10, 11, 12, 111, and 121. The connection between these standard Parts is shown in Figure 39. Each project (the top-level entity) has its workpiece and workplan. Workpiece has fixture, property parameters, and material information. Workplan indicates in what way the project is executed (through `nc_function`, `program_structure`, or `workingstep`). `Nc_function` describes switching operations or other non-interpolating machine functionality. `Program_structure` is for building logical blocks for structured programming of manufacturing operations. `Workingstep` describes manufacturing or handling operations which involve interpolating axes, whose execution normally spans a certain period of time and which can only be executed in conjunction with a workpiece. This research focuses on using workingsteps to execute manufacturing projects.

Each workingstep can be one of three types: `rapid_movement`, `machining_workingstep`, and `dm_workingstep`. Rapid movements are used between two workingsteps, which is not considered in this research. `Machining_workingstep` represents the machining process for a specific area of the workpiece. `Machining_workingstep` specifies the association between a distinct feature (information defined in Part 10 represented in green colour box) and an operation to be performed on that feature. As the underlying operations, `machining_workingstep` is characterised by the use of a single tool (information defined from Part 111 for milling and Part 121 for turning represented in pink colour box) and a set of technological parameters (information defined in Part 11 for milling and Part 12 for turning represented in yellow box).

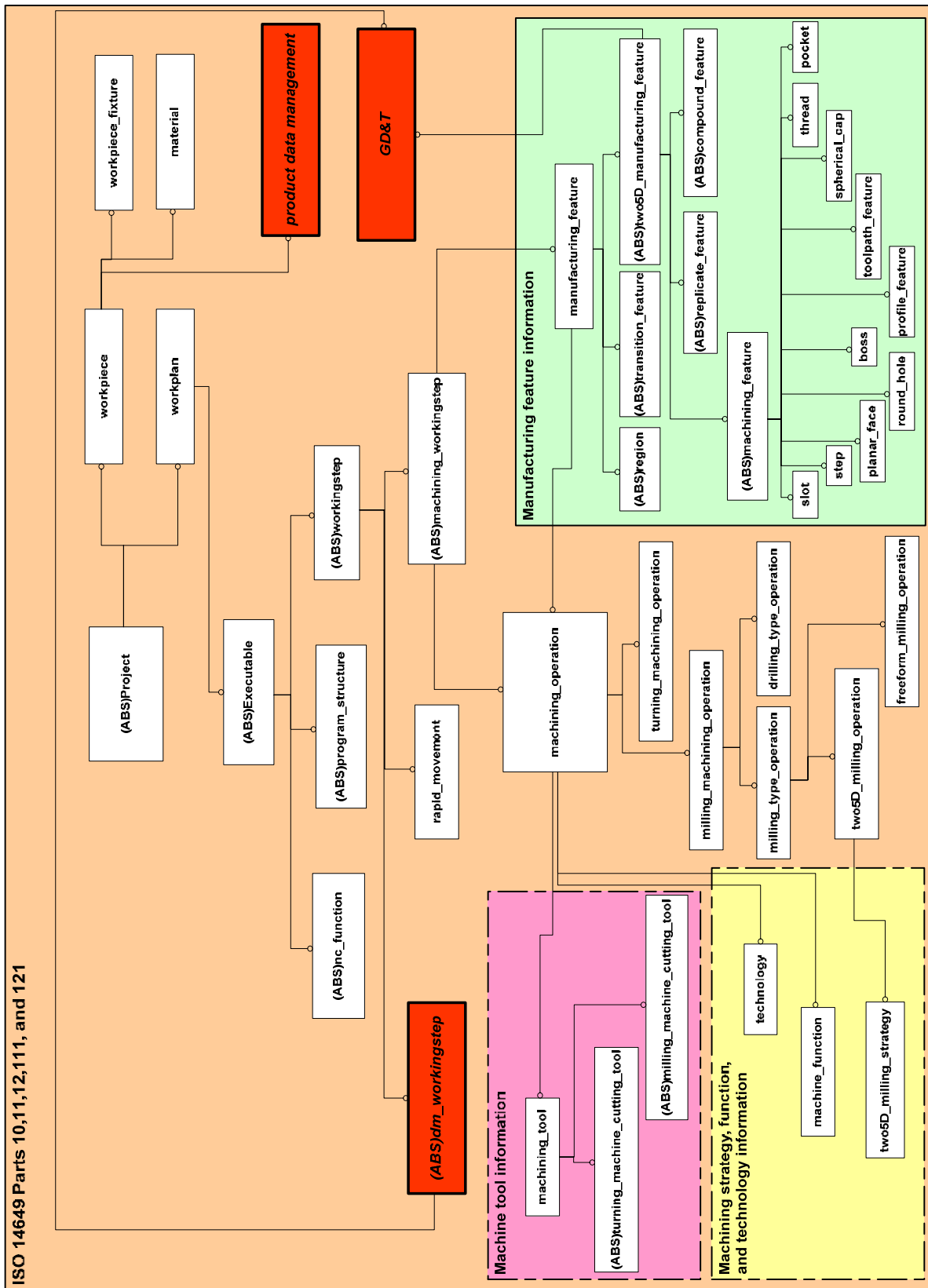

Figure 39: Information defined in ISO 14649 Parts 10, 11, 12, 111, and 121

Dm\_workingstep, GD&T, and product data management definitions is new information (in red box) and is harmonized from the existing STEP Parts and APs with certain modifications that enable proper link between other definitions. Dm\_workingstep represents dimensional measurement workingstep and operation related information. They are from AP 219 and HIPP data model. Product data management information is harmonized from ISO 10303 modules 1012 [133] and 1015 [134]. It defines product approval (status, date, purpose) information, security information (security classification, assigned person and organizations), and modification timestamp information. Some of the product data management entities are shown as follows. GD&T definitions will be introduced in Section 4.2.3.

```

TYPE last_modified_timestamp_item = SELECT (executable,
                                           operation,
                                           project,
                                           toolpath,
                                           workpiece );

END_TYPE;

ENTITY last_modified_timestamp;
  date_and_time_value      : date_and_time;
  items                    : SET [1:?] OF last_modified_timestamp_item;
END_ENTITY;

ENTITY approval;
  status                   : approval_status;
  purpose                  : STRING;
  planned_date             : OPTIONAL STRING;
  actual_date              : OPTIONAL STRING;
END_ENTITY;

ENTITY approval_relationship;
  relation_type            : STRING;
  relating_approval        : approval;
  related_approval         : approval;
  description              : OPTIONAL STRING;
END_ENTITY;

TYPE security_classification_item = SELECT (executable,
                                           operation,
                                           project,
                                           toolpath,
                                           workpiece );

END_TYPE;

ENTITY security_classification;
  classification_level     : STRING;
  description              : STRING;
END_ENTITY;

```

```

ENTITY assigned_person;
    person_and_organization_value : person_and_organization;
    role                           : STRING;
END_ENTITY;

ENTITY assigned_organization;
    organization_value             : organization;
    role                           : STRING;
END_ENTITY;

```

Dimensional measurement workingsteps represent the measurement process for a specific area on the workpiece. Similar to machining workingsteps, they cannot exist independently of a measurement feature. Dimensional measurement workingsteps always associate a measurement operation with a measurement feature. Each dimensional measurement workingstep uses a single measurement device and a set of technological parameters for measurements.

Figure 40 displays the connection between these information definitions. The definitions of `dm_workingstep` and `dm_operation` are harmonized from HIPP data model proposed by NIST. Dimensional measurement feature definitions are harmonized from AM 219 with minor modifications to link with other entities.

```

ENTITY dm_workingstep
    SUBTYPE OF (workingstep);
    its_feature           : dm_feature;
    its_tolerances        : SET [1:?] OF geometric_tolerance;
    its_device            : OPTIONAL dm_device_resource;
    its_accuracy_requirements : OPTIONAL SET [1:?] OF
        dm_accuracy_requirement_local;
    its_operation         : OPTIONAL dm_operation;
    its_data_report       : OPTIONAL STRING;
END_ENTITY;

```

`Dm_feature` has two subtypes: `dm_simple_feature` and `dm_composite_feature` (Figure 41). Each of these has multiple subtypes identifying most of the common features in inspection process planning, such as 3D measurement features-- tuboid, cone, cylinder, and composite measurement features—pattern features and compound features. Some of the dimensional measurement feature definitions in EXPRESS are shown as follows.

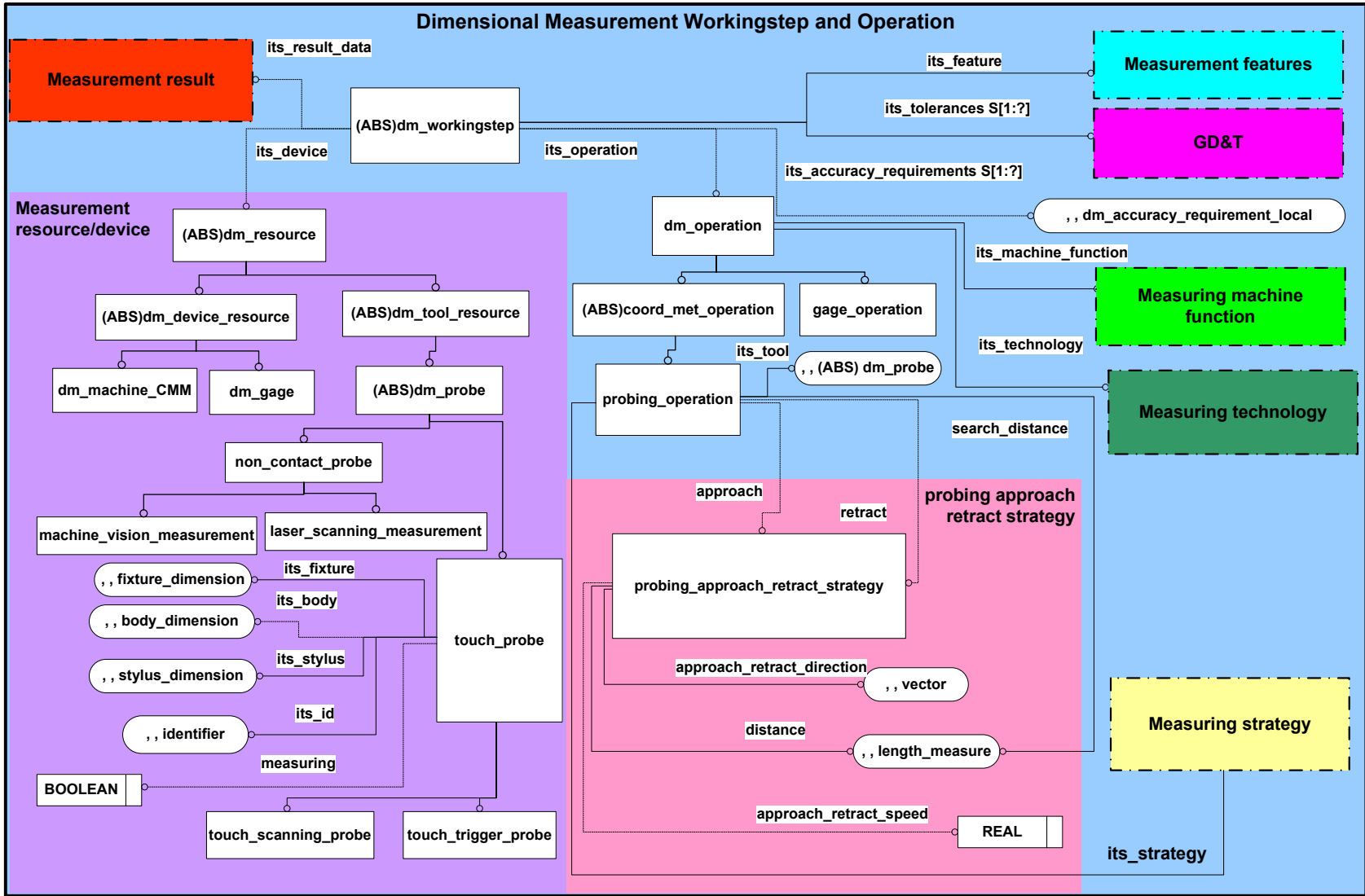

Figure 40: Dimensional measurement related information definitions

```

ENTITY dm_feature
  ABSTRACT SUPERTYPE OF (ONEOF (dm_composite_feature,
                                dm_simple_feature));
  its_id                : identifier;
  its_workpiece         : workpiece;
  its_related_machining_operations : OPTIONAL SET [0:?] OF
                                machining_operation;
  its_operations        : OPTIONAL SET [0:?] OF
                                dm_operation;
  feature_placement    : axis2_placement_3d;
END_ENTITY;

ENTITY dm_composite_feature
  ABSTRACT SUPERTYPE OF (ONEOF (dm_compound_feature, dm_pattern_feature))
  SUBTYPE OF (dm_feature);
END_ENTITY;

ENTITY dm_simple_feature
  ABSTRACT SUPERTYPE OF (ONEOF (dm_feature_point, dm_feature_line,
                                dm_simple_feature_2d,
                                dm_simple_feature_3d))
  SUBTYPE OF (dm_feature);
  explicit_representation : OPTIONAL SET [1:?] OF explicit_item;
END_ENTITY;

ENTITY dm_simple_feature_3d
  ABSTRACT SUPERTYPE OF (ONEOF (dm_feature_inout_3d, dm_feature_gsurf))
  SUBTYPE OF (dm_simple_feature);
END_ENTITY;

ENTITY dm_feature_inout_3d
  ABSTRACT SUPERTYPE OF (ONEOF (dm_feature_cone,
                                dm_feature_cylinder,
                                dm_feature_planes,
                                dm_feature_rev_surf,
                                dm_feature_sphere,
                                dm_feature_torus,
                                dm_feature_tuboid))
  SUBTYPE OF (dm_simple_feature_3d);
  inout                : inner_outer;
END_ENTITY;

ENTITY dm_feature_cone
  SUPERTYPE OF (dm_feature_cone_seg)
  SUBTYPE OF (dm_feature_inout_3d);
  whole_angle          : plane_angle_measure;
END_ENTITY;

```

Apart from `dm_workingstep`, `dm_feature`, and `dm_operation`, the rest of dimensional measurement related information can be divided into seven groups represented by different colours (Figure 40).

- 1) GD&T information (purple box)
- 2) Measurement resource and device information (light purple box)

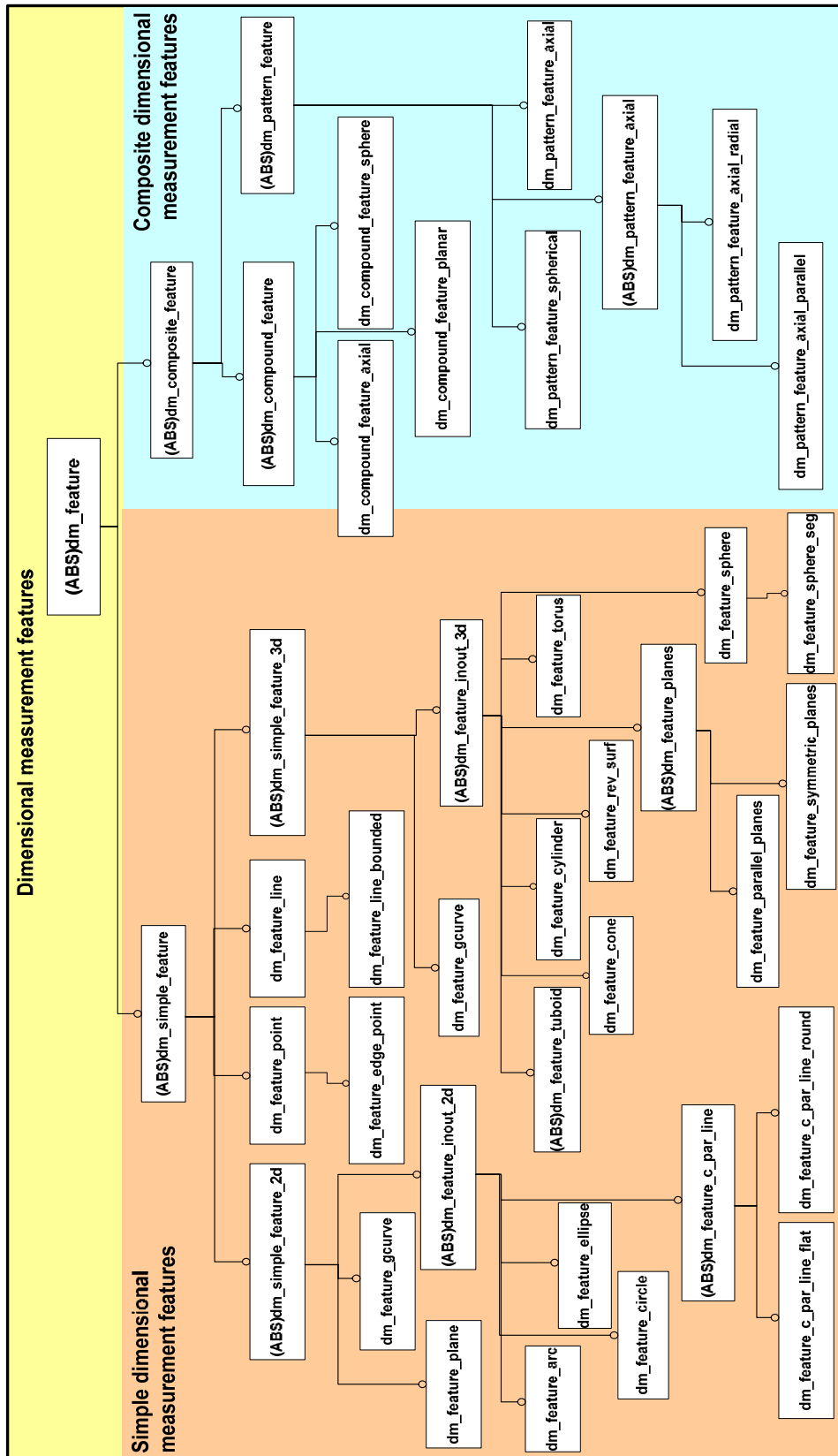

Figure 41: EXPRESS-G diagram of dimensional measurement features



- 3) Probing approach and retract strategy (pink box)
- 4) Measurement machine functions (green box)
- 5) Measurement technology (dark green box)
- 6) Measurement strategy (yellow box)
- 7) Measurement result (red box)

These definitions comprise an essential contribution from this research. Figure 40 depicts the measurement process and device related definitions in the proposed data model. The measurement resource and device information is linked with `dm_workingstep` by attribute `its_device`. Measurement device definitions consist of the inspection equipment type, its dimensions, and its capability information. The EXPRESS definition of `touch_probe` is as follows.

```
ENTITY touch_probe
  SUPERTYPE OF (ONEOF (touch_scanning_probe, touch_trigger_probe))
  SUBTYPE OF (dm_probe);
  measuring           : OPTIONAL BOOLEAN;
  its_fixture         : fixture_dimension;
  its_body            : OPTIONAL body_dimension;
  its_stylus          : SET [1:?] OF stylus_dimension;
END_ENTITY;

ENTITY touch_scanning_probe
  SUBTYPE OF (touch_probe);
END_ENTITY;
```

`Probing_operation` has attribute `search_distance` to tell the measurement device how far the probe should continue beyond the nominal hit point before aborting it. Probing approach and retract strategy is also defined in this data model as entity `probing_approach_retract_strategy`. Compared with machining approach and retract strategy (which has three main types: `plunge_strategy`, `air_strategy`, and `along_path`), probing approach and retract motion are much simpler. In order to probe accurately, the probe always moves in a straight line from the approach point to the hit point, and the line of approach is as nearly normal to the surface to be probed as possible. The probe always performs an air move as it approach the point. Therefore, the approach and retract requires distance, direction, and vector information. The EXPRESS definitions of `probing_operation` and `probing_approach_retract_strategy` are shown as follows.

```

ENTITY dm_operation
  SUPERTYPE OF (ONEOF (coord_met_operation, gage_operation))
  SUBTYPE OF (operation);
  its_id                : identifier;
  retract_plane         : OPTIONAL length_measure;
  start_point           : OPTIONAL cartesian_point;
  its_technology        : technology;
  its_machine_functions : machine_functions;
END_ENTITY;

ENTITY probing_operation
  SUBTYPE OF (coord_met_operation);
  its_tool              : OPTIONAL dm_probe;
  approach              : OPTIONAL probing_approach_retract_strategy;
  retract              : OPTIONAL probing_approach_retract_strategy;
  its_probing_strategy : OPTIONAL coord_met_strategy;
  search_distance       : length_measure;
END_ENTITY;

ENTITY probing_approach_retract_strategy
  approach_retract_direction : direction;
  distance                   : length_measure;
  approach_retract_speed    : REAL;
END_ENTITY;

```

### 4.2.3. GD&T Data Definitions

It is introduced in Chapter 2 that the lack of proper GD&T definition in current dimensional metrology standards is a crosscutting issue that affects interoperability for both product definition and inspection process definition activities. In STEP standards, Part 47 [135], AP 203 (edition 2), AP 214, and AP 224 all have GD&T definitions. ISO 10303 Part 47 has generic definitions of shape deviations and tolerances. AP 203 second edition made use some of the GD&T definitions from Part 47. However, these GD&T definitions are only for annotation purposes. This is similar to in AP 214, where GD&T definitions are also used for annotations. The GD&T definitions in AP 224 are the most suitable ones for supporting automatic inspection process plan generation. It is, though, not fully linked with machining features and operation information. The names of GD&T entities also differ in different STEP Parts and APs. Therefore, in this research, GD&T definitions in these STEP Parts and APs are reviewed first. Then, harmonization is carried out to standardize the GD&T entity names and their attributes (the information they define).

The next step is to develop a mechanism to link GD&T information with machining operations and feature information. This is crucial for generating in-process measurement

operations automatically. In this research, a bi-directional linkage is added between two5D\_manufacturing feature and GD&T entities. Figure 42 shows the EXPRESS-G diagram of the proposed GD&T definitions in the proposed ARM model. It can be seen that GD&T information can be traced from a manufacturing feature, which is a part of a two5D\_manufacturing\_feature (which connects machining\_operation), or from a dm\_workingstep (Figure 39).

If a tolerance is applied to a 2.5D manufacturing feature, the tolerance information is linked through the two5D\_manufacturing\_feature entity. The EXPRESS definition is shown as follows. At the same time, abstract supertype tolerance has two subtypes: geometric\_tolerance and dimensional\_tolerance. They both have an attribute feature\_applied\_to, which leads back to the manufacturing feature that the tolerance is applied to. This linkage guarantees that the process planning system (either inspection process planning or machining process planning) can trace tolerance and machining feature information from both directions.

```

ENTITY two5D_manufacturing_feature
  ABSTRACT SUPERTYPE OF (ONEOF(machining_feature,
                                replicate_feature,
                                compound_feature))
  SUBTYPE OF (manufacturing_feature);
  feature_placement      : axis2_placement_3d;
  its_applied_tolerance  : OPTIONAL SET [0:?] OF tolerance;
END_ENTITY;

ENTITY tolerance
  ABSTRACT SUPERTYPE OF (ONEOF(geometric_tolerance,
                                dimensional_tolerance));
END_ENTITY;

```

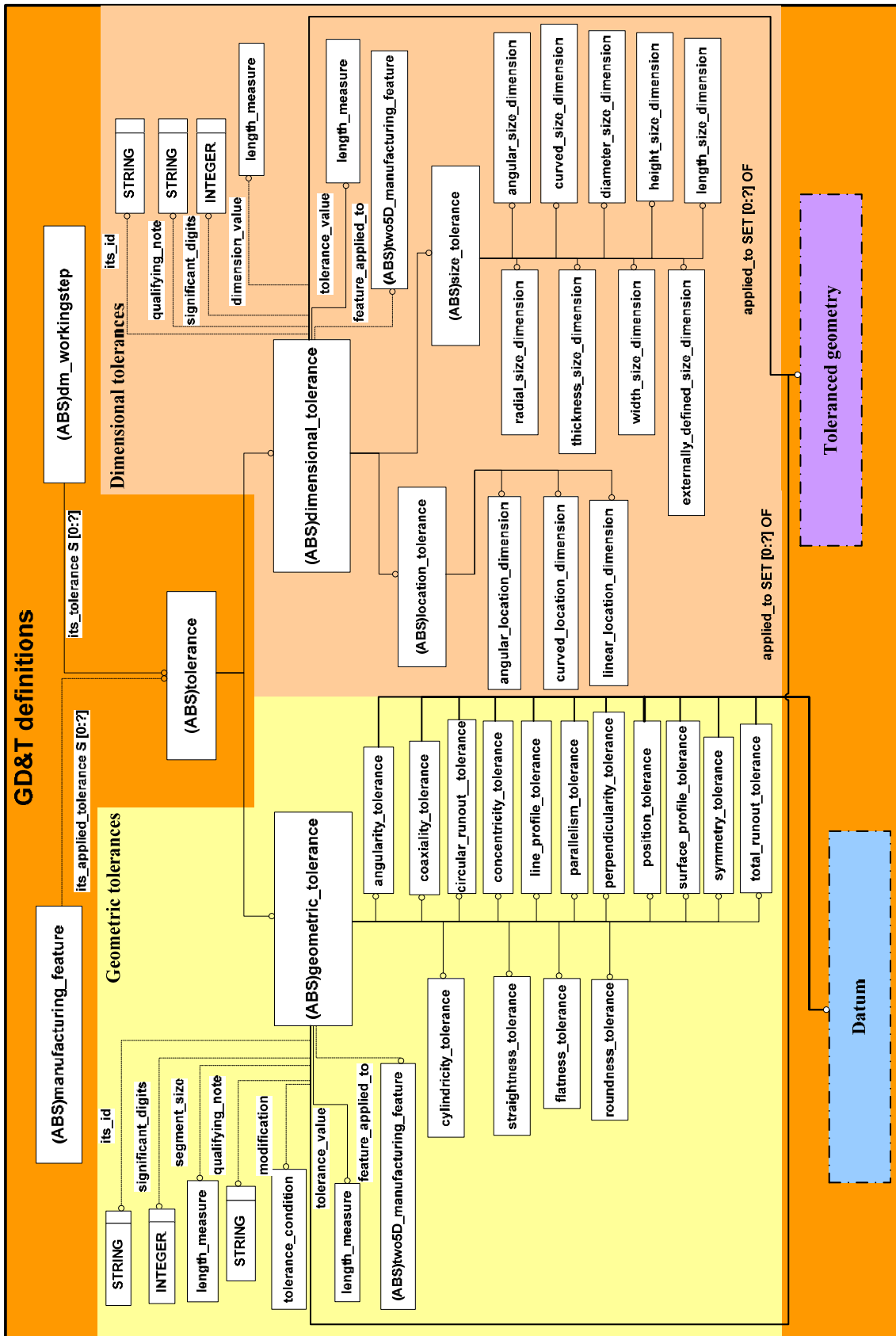

Figure 42: GD&T definitions in the proposed data model

```

ENTITY geometric_tolerance
  ABSTRACT SUPERTYPE OF (ONEOF (angularity_tolerance,
                                circular_runout_tolerance,
                                coaxiality_tolerance,
                                concentricity_tolerance,
                                cylindricity_tolerance,
                                flatness_tolerance,
                                line_profile_tolerance,
                                parallelism_tolerance,
                                perpendicularity_tolerance,
                                position_tolerance,
                                roundness_tolerance,
                                straightness_tolerance,
                                surface_profile_tolerance,
                                symmetry_tolerance,
                                total_runout_tolerance))

SUBTYPE OF (tolerance);
  its_id           : OPTIONAL STRING;
  applied_to      : SET [0:?] OF toleranced_geometry;
  feature_applied_to : OPTIONAL two5D_manufacturing_feature;
  modification    : OPTIONAL tolerance_condition;
  qualifying_note  : OPTIONAL STRING;
  segment_size    : OPTIONAL length_measure;
  significant_digits : OPTIONAL INTEGER;
  tolerance_value  : length_measure;

WHERE
  WR1: (NOT (EXISTS(segment_size))) OR
  ('MACHINING_SCHEMA.LENGTH_MEASURE' IN
  TYPEOF(segment_size.value_component));
  WR2: (NOT (EXISTS(tolerance_value))) OR
  ('MACHINING_SCHEMA.LENGTH_MEASURE' IN
  TYPEOF(tolerance_value.value_component));
  WR3: (NOT (EXISTS(significant_digits))) OR (significant_digits > 0);
END_ENTITY;

ENTITY dimensional_tolerance
  ABSTRACT SUPERTYPE OF (ONEOF(location_tolerance,
                                size_tolerance))

SUBTYPE OF (tolerance);
  its_id           : OPTIONAL STRING;
  applied_to      : toleranced_geometry;
  feature_applied_to : OPTIONAL two5D_manufacturing_feature;
  qualifying_note  : OPTIONAL STRING;
  dimension_value  : OPTIONAL length_measure;
  significant_digits : OPTIONAL INTEGER;
  tolerance_value  : length_measure;
END_ENTITY;

```

Depending on the types of tolerance, datum information is required. For example angularity must have datum information. Datum information is linked to angularity\_tolerance by reference\_datum attribute. Datum definitions are shown in Figure 43. Some of the datum related information definition is shown in EXPRESS schema as follows.

```

ENTITY angularity_tolerance
  SUBTYPE OF (geometric_tolerance);
  affected_plane      : OPTIONAL axis_placement;
  reference_datum     : SET[1:2] OF datum_reference;
  value_qualifier     : OPTIONAL BOOLEAN;
END_ENTITY;

ENTITY datum_reference;
  precedence          : INTEGER;
  referenced_datum    : datum;
END_ENTITY;

ENTITY datum
  ABSTRACT SUPERTYPE (ONE OF (single_datum, common_datum));
END_ENTITY;

ENTITY single_datum
  SUBTYPE OF (datum);
  datum_name          : STRING;
  modification        : OPTIONAL tolerance_condition;
END_ENTITY;

```

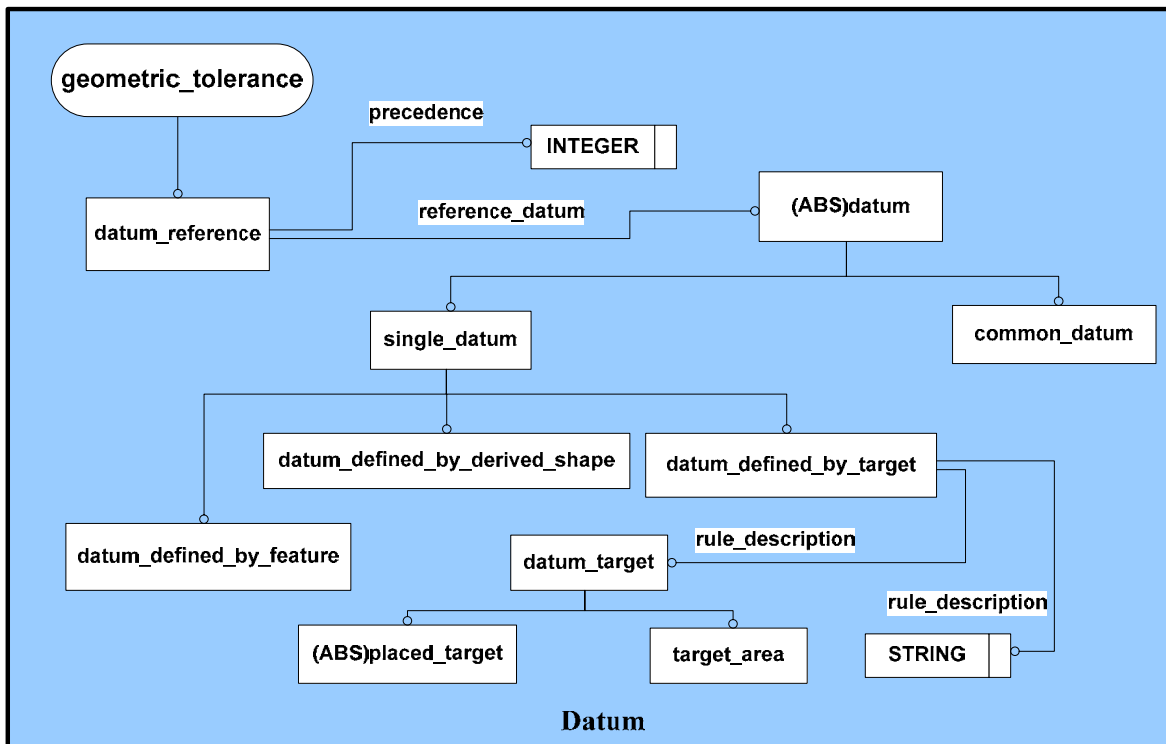
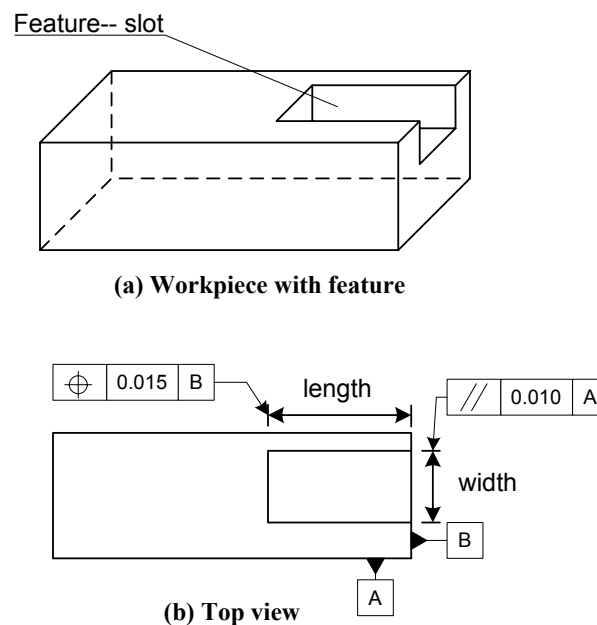

Figure 43: Datum information definitions

Although there is a bi-directional linkage between machining features and tolerances, this link is still incomplete. Tolerances can be applied only to geometry but not to features. For example in Figure 44, a slot is a machining feature, to which a position tolerance and a

parallelism tolerance are applied. However, these two tolerances are only applied to different surfaces of the slot. How to model this type of information (link) is vital to support automated process planning.

In this research, a set of new entities were defined to facilitate the modelling of this information linkage. Both `geometric_tolerance` and `dimensional_tolerance` have an attribute called `applied_to`, which leads to entity `toleranced_geometry`. The `toleranced_geometry` entity defines the geometry of a feature to which tolerance has been applied to. It has seven subtypes including six basic geometric elements such as line, plane, cylinder, etc, and a `toleranced_profile` subtype.



**Figure 44: Relationship between machining features and tolerances**

Most contemporary CAD systems use a feature-based design approach for geometry modelling [136]. In a design for the example shown in Figure 44, the feature slot has two applied tolerances -- parallelism and position. Parallelism tolerance is applied on one side of the slot surface, and position tolerance on the other. When assigning these two tolerances to the geometry element of the slot, which is a plane in this example, the tolerance information and the size of the two planes can be saved into a STEP file. Hence,

process planners can trace tolerance type, value, and datum information together with the tolerance applied geometric elements size information from the STEP file. Figure 45 illustrates the application of toleranced\_geometry in the example shown in Figure 44. The EXPRESS-G diagram of toleranced\_geometry definition is displayed in Figure 46. Some of the toleranced\_geometry EXPRESS definitions are shown as follows.

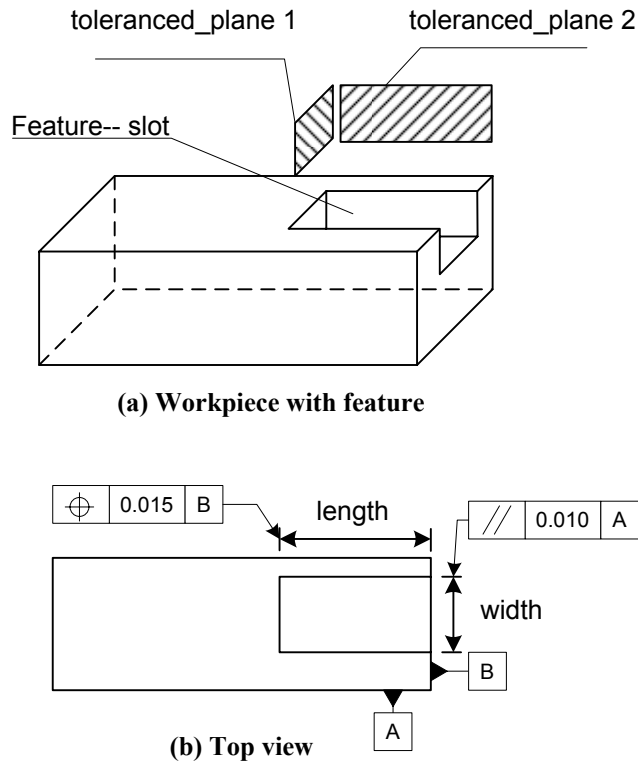

Figure 45: Illustration of feature and toleranced\_geometry

```

ENTITY toleranced_geometry
  ABSTRACT SUPERTYPE OF (ONEOF (toleranced_line,
                                toleranced_plane,
                                toleranced_circle,
                                toleranced_cylinder,
                                toleranced_cone,
                                toleranced_sphere));

  its_id      : STRING;
END_ENTITY;

ENTITY toleranced_line
  SUBTYPE OF (toleranced_geometry);
  pnt        : cartesian_point;
  dir        : vector;
WHERE
  WR1: dir.dim = pnt.dim;
END_ENTITY;

```





```

ENTITY toleranced_plane
  SUBTYPE OF (toleranced_geometry);
  feature_placement      : axis2_placement_3d;
  plane_length          : OPTIONAL length_measure;
  plane_width           : OPTIONAL length_measure;
  plane_boundary        : OPTIONAL LIST [3:?] OF edge;
END_ENTITY;

ENTITY toleranced_circle
  SUBTYPE OF (toleranced_geometry);
  position              : axis2_placement_3d;
  radius                : positive_length_measure;
END_ENTITY;

```

The proposed GD&T definitions also harmonize tolerance zone related definitions from AP 214 and AP 224. For example, in the position\_tolerance entity, the attribute called value\_qualifier indicates whether the tolerance zone is a cylindrical shape (Figure 47).

```

ENTITY position_tolerance
  SUBTYPE OF (geometric_tolerance);
  affected_plane        : OPTIONAL axis_placement;
  reference_datum       : SET[0:3] OF datum_reference;
  value_qualifier       : OPTIONAL BOOLEAN;
END_ENTITY;

```

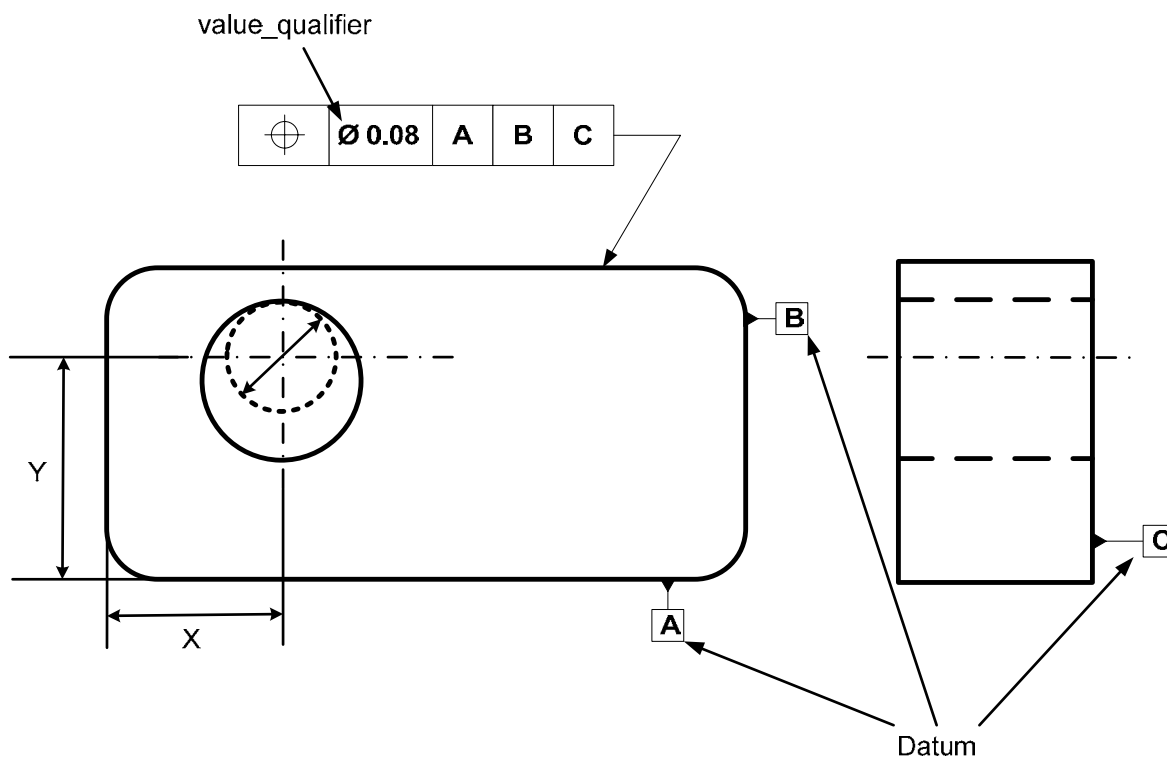

Figure 47: Illustration of value\_qualifier attribute

To summarize, the proposed GD&T data definitions consist of the harmonized GD&T definitions from the existing STEP Parts and APs and the newly defined mechanism to link machining feature, tolerance, and tolerance applied geometry. Therefore, the data model is able to keep and pass complete tolerances and their associated feature information downstream to process planning.

#### 4.2.4. Measurement Technological Information Definitions

To have a complete data model for measurement process (both post-process and in-process measurement), measurement technology, strategy, measurement machine functions, and measurement results are necessary to be modelled. Measurement result is defined as an attribute of `dm_workingstep` (Figure 48). It is able to record measured points and measurement result type.

```
ENTITY dm_result
  ABSTRACT SUPERTYPE;
  its_result_type           : dm_result_select;
  its_result_analysis_model : OPTIONAL
    dm_result_analysis_model_select;
  circumstances            : OPTIONAL LIST [1:?] OF
    dm_circumstance_select;
  measured_points          : OPTIONAL SET [0:?] OF cartesian_point;
END_ENTITY;
```

Probing strategy defines the commonly used probing path for basic geometric elements and for custom created probing paths. The current ARM data model focuses on defining strategies for measurement processes using touch trigger probes (`touch_probing_strategy`). It includes the strategy information such as a set of Cartesian points to measure, probing path, the `dm_feature` to measure, and sub-strategy to measure primitive geometry (e.g., `planar_face`, `cylinder`).

```
ENTITY touch_probing_strategy
  SUPERTYPE OF (ONEOF ( line_probing_strategy,
    planar_face_probing_strategy,
    circle_probing_strategy,
    sphere_probing_strategy,
    cylinder_probing_strategy,
    cone_probing_strategy,
    freeform_probing_strategy))
  SUBTYPE OF (OMM_coord_met_strategy);
  its_measurement_points : OPTIONAL SET[0:?] OF cartesian_point;
  its_probing_path       : OPTIONAL probing_path;
END_ENTITY;
```

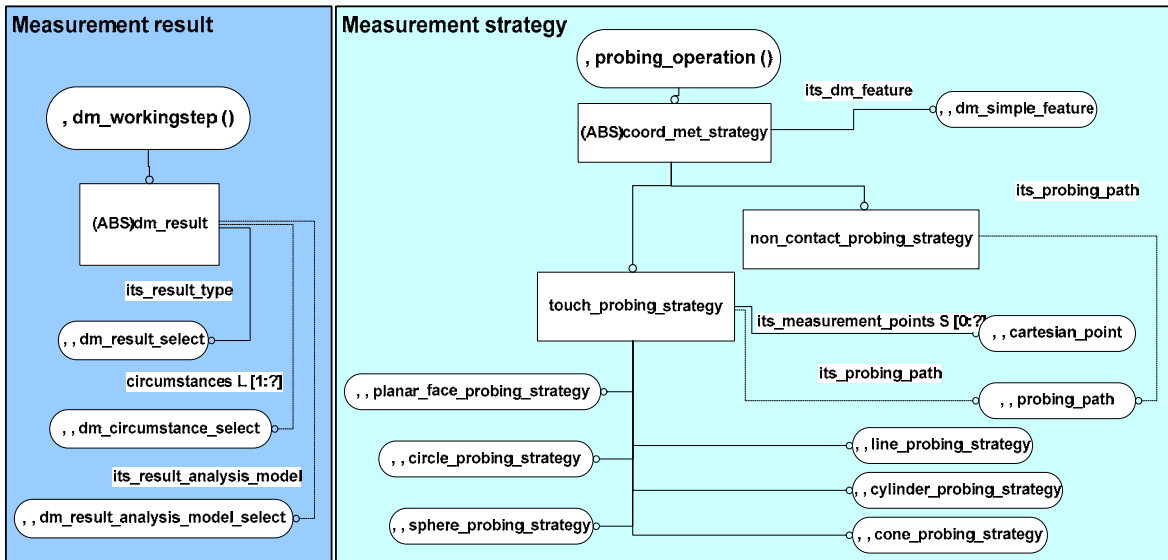

Figure 48: Measurement result and measurement strategy definitions

The measurement technology (Figure 49), which is a subtype of technology (on the same level as milling\_technology), defines probing speed information. Measurement machine functions define information about probe status, workpiece cleaning, and machine axis constraints.

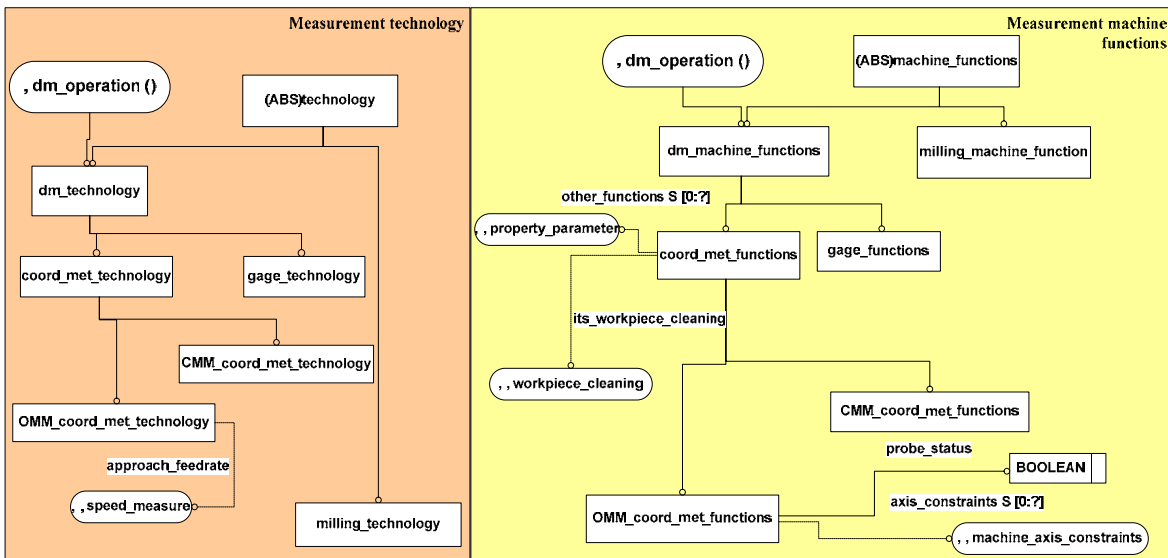

Figure 49: Measurement technology and measurement machine function definitions

The EXPRESS definition of entity coord\_met\_functions is shown as follows

```
ENTITY coord_met_functions
  SUPERTYPE OF (ONEOF (OMM_coord_met_functions, CMM_coord_met_functions))
  SUBTYPE OF (dm_machine_functions);
  its_workpiece_cleaning      : OPTIONAL workpiece_cleaning;
  its_process_model          : OPTIONAL process_model_list;
  other_functions            : SET [0:?] OF property_parameter;
END_ENTITY;
```

### 4.3. Recap

This chapter reviews the STEP/STEP-NC related CAIPP research and standard development. It is found that the inspection related STEP/STEP-NC Parts and APs are incomplete, and many of them are still in drafting stage. The related CAIPP research mostly focused on testing the feasibility of the STEP data model for inspection process planning. Some of the research improved upon ISO 14649 Part 16 and AP 219 though they are not complete. Among the reviewed research, CMM is still the main method for carrying out measurement operations. In-process measurement was not considered.

Lack of completeness and differing definitions for the same information in different STEP/STEP-NC Parts and APs are a pressing issue that the STEP committee and dimensional metrology standard development committee are trying to solve. Some conjoined meetings have already been held to address these issues.

In this research, a STEP Application Protocol ARM data model for integrated CNC machining and inspection is developed. The AAM model of the integrated process planning system is first developed to identify what information the data model should contain. Then the data model is developed in three stages: investigating existing STEP/STEP-NC Parts and APs, identifying and harmonizing existing inspection and machining process/operation information definitions, and augmenting the data model with the newly defined information. Among the new definitions, GD&T information, the mechanism to link machining feature and tolerance information, measurement process technological information are the main contributions of this research.

# *Chapter 5 Proposed Integrated Process Planning System*

Chapter 2 described the need to have a comprehensive and consolidate data model for the entire machining chain in order to achieve a fully automated machining process with real-time feedback from dimensional measurement. Chapter 4 introduced the proposed STEP Application Protocol ARM data model for integrated CNC machining and inspection. The data model integrates and harmonizes the existing machining and inspection process definitions from STEP/STEP-NC Parts and APs with newly defined in-process measurement related information. With sufficient information provided by the proposed data model, an integrated machining and inspection process planning system with real-time feedback is achieved.

This chapter describes the proposed integrated process planning system. The major part of this chapter has been reported in one published journal paper [1] one journal paper *in-press* [4] and also presented at two international conferences [6, 7].

Figure 50 presents an overall picture of the STEP-based CLM system architecture and highlights the integrated process planning and feedback system as the core and also the focus of current research.

The STEP-based CLM system architecture consists of five parts.

- 1) Feature recognition and pre-machining process planning system
- 2) Integrated machining and OMM process planning system
- 3) Micro machining process planning system
- 4) Micro inspection process planning system
- 5) Inspection result analysis and feedback/update system

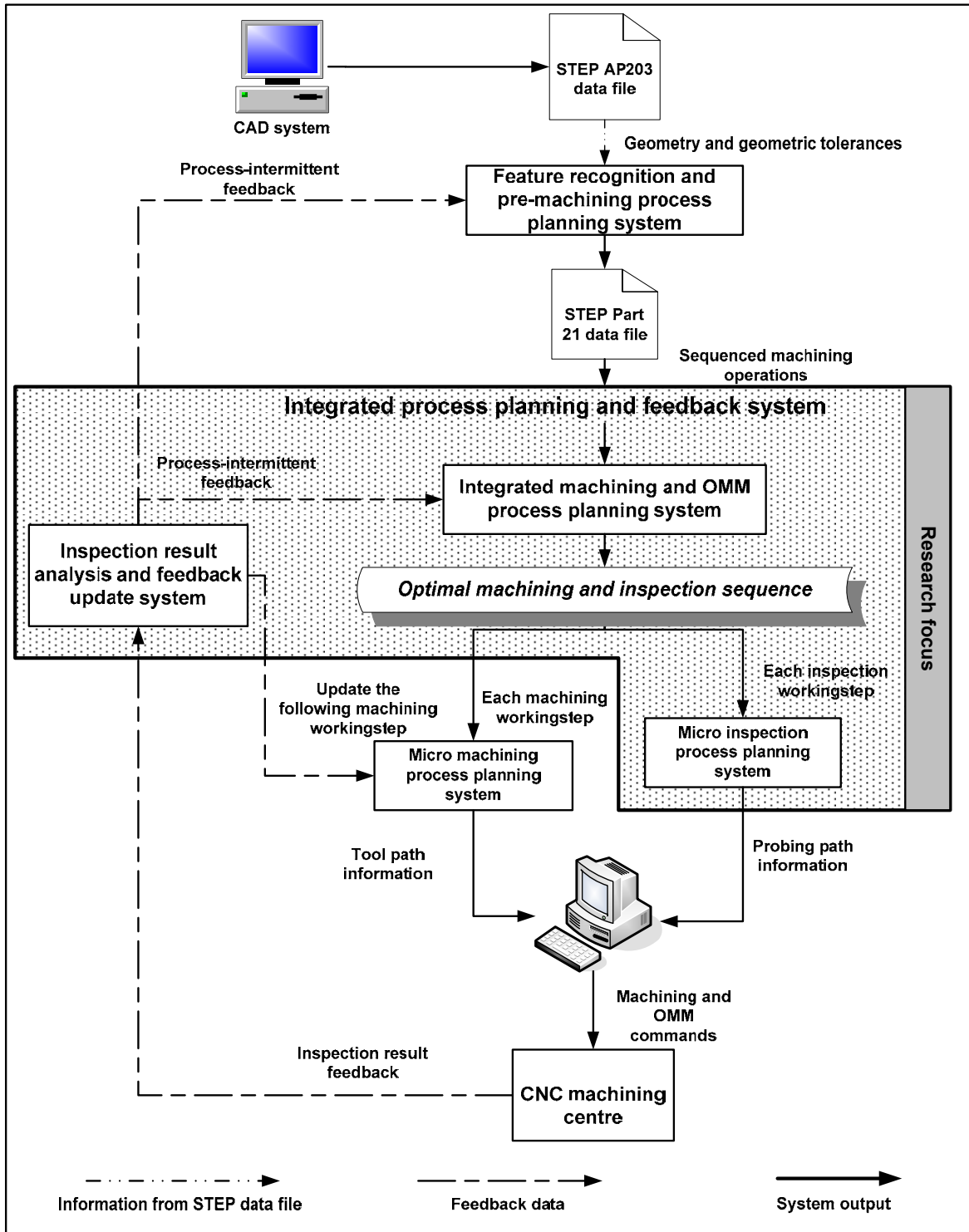

Figure 50: Proposed STEP-based CLM system architecture

CAD software is now able to generate AP 203 data for a designed part. The AP 203 file contains geometric representation of manufacturing features and GD&T information (AP 203 edition 2). As seen in Figure 50, the geometric representation data is converted into feature information through a feature recognition system. This process is mainly responsible for feature recognition and feature interaction detection. Then, a pre-machining process planning is carried out to decide the sequence of manufacturing features and their related operation orders. The output file is an ISO 10303 Part 21 file. It includes information of workplan, machining\_workingsteps, machining\_features and GD&T requirements.

In order to gain feedback and to monitor the machining process, it is necessary that in-process measurements are incorporated, or rather inserted in-between machining\_workingsteps. On-machine measuring operations are chosen in this research to carry out in-process measurement. In this way, the measurement operation insertion process is accomplished by the integrated machining and OMM process planning system. Measurement geometry is firstly selected/created based on machine accuracy, tolerance requirements, and the association between tolerances and manufacturing features. The sequence of the measurement geometry is then determined by the order of machining features and their machining operations. Each machining feature may have multiple machining operations through which the machining features is created, i.e. semi-finishing or finishing operations. Then, corresponding inspection operations are inserted in-between machining operations. The detailed structure of this integrated OMM process planning system is described in Section 5.1.

After the new machining and inspection operation sequence is determined, micro-level machining and inspection process planning is carried out. The micro machining process planning system focuses on assigning proper cutting tools to each machining workingstep and determining the tool-path and machining parameters (e.g., cutting speed, feed rate) for the features. The micro inspection process planning system determines the number of measurement points for each inspection feature, distributes these points, reallocates these points when feature interaction occurs, and plans the probing path. These machining and measurement commands generated by the micro-level process planning systems are given to CNC machines for execution.



The inspection results are then collected and input to the analysis and feedback/update system which generates process-intermittent feedback to the process planning system ( e.g. to the pre-machining process planning or the integrated machining and OMM process planning system) (Figure 50), depending on the results of analysis. If the analysis suggests an update to the pre-planned machining operation sequence, the feedback is input to the pre-machining process planning system. If the analysis shows that an adjustment is needed for the subsequent machining operations, the feedback is input to the integrated machining and OMM process planning system.

### **5.1. Integrated Process Planning and Feedback System**

As shown in Figure 50, the core element of the entire STEP-based CLM architecture is the integrated process planning and feedback system. This is also the focus of this research. A detailed structure of this system is illustrated in Figure 51. The system consists of four sub-systems serving the following purposes, respectively.

- 1) Selection/creation of geometry to be measured
- 2) Inspection operation insertion
- 3) Micro inspection process planning
- 4) Measurement results analysis and feedback

As shown in Figure 51, the input file to the system is a STEP Part 21 physical file. This file is firstly parsed through a tolerance filter, in which tolerance information is analyzed and critical tolerances are identified based on the design requirement, machine tool's characteristics, and other product related information. The geometry that is related to the critical tolerances is determined and will be monitored by OMM. Based on the relationship between the geometry and the machining feature, measurement geometry is then selected/created based on the measurement geometry decision rules. The capability and performance of the machine tool is considered in determining the number of inspection operations. The goal is to keep inspection operations to a minimum but adequate level.

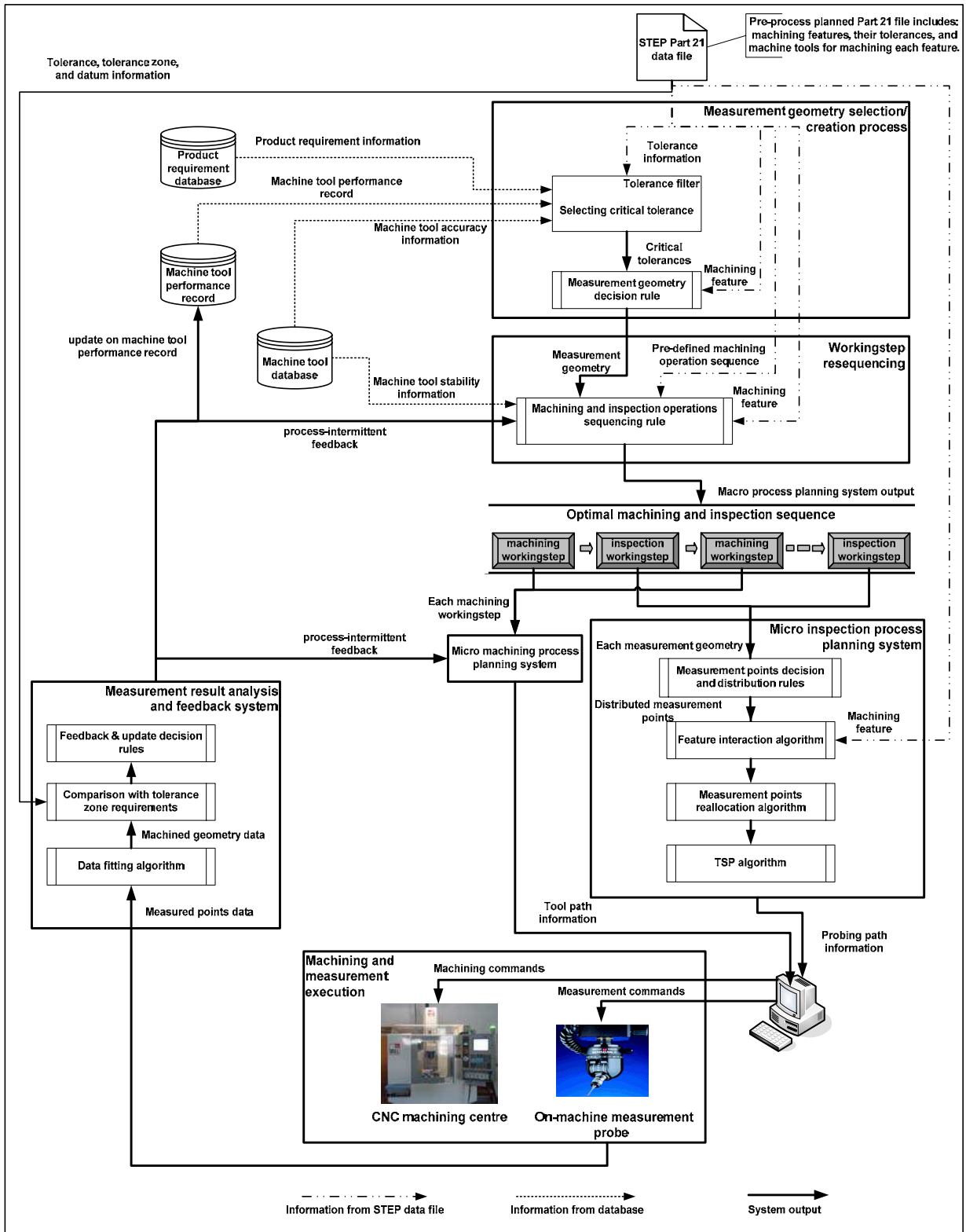

Figure 51: Proposed integrated process planning system framework

The next step is inspection operation insertion. This process includes two sub-processes: (a) the pre-defined machining workingstep is re-sequenced first based on the chosen machine accuracy and applied tolerance tightness, then (b) newly generated inspection workingsteps are inserted in-between those re-sequenced machining workingsteps. This measurement geometry selection/creation system and the workingstep re-sequence process are described in detail in Sections 5.2 and 5.3, respectively.

After the new machining and inspection operation sequence is generated, micro machining and inspection process planning is carried out. This research has a focus on the micro inspection process planning system, which consists of four sub-systems. They are measurement points decision and distribution, feature interaction detection, measurement points reallocation, and probing points re-sequence. This system is fully described in Section 5.4.

After micro-level process planning, machining commands together with the OMM inspection commands are passed to a machine centre for execution. After each inspection operation, measurement results are analysed and update is made for the subsequent machining operations. This measurement result analysis and feedback system consists of three sub-systems. They are data fitting, tolerance zone analysis and comparison, and feedback and update. This system is discussed in Section 5.5.

### **5.2. Measurement Geometry Selection/Creation System**

The functionalities of the measurement geometry selection/creation system include identifying critical tolerances and then choosing the concerned geometry for measurement. The former is achieved by the tolerance filter and the later by decision rules.

#### **5.2.1. Tolerance Filter**

Tolerance requirement(s) for each machining feature is parsed from a STEP file and comparison between tolerance(s) and machine accuracy is made to determine which are the critical tolerances to inspect between machining operations. It is important to clarify that the proposed integrated process planning system is highly machine-dependent. That means decision-making involves the accuracy of the chosen machine tool. The developed

software prototype allows operators to choose a CNC machine (refer to Chapter 6). Different CNC machines have different characteristics, for example, the state-of-the-art CNC machines tend to have higher accuracy and better repeatability than the legacy CNC machines. Parallel machine tools are good at producing cylinders but not good at controlling flatness tolerance [137]. For each machine tool, there are two types of accuracy values (Figure 52) – possible accuracy and guaranteed accuracy.

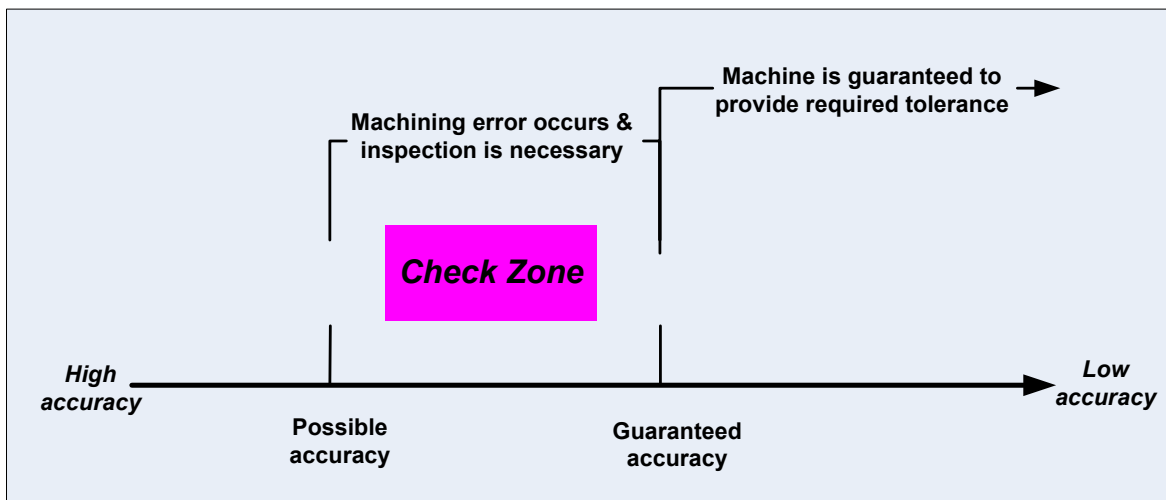

Figure 52: Machine accuracy information

Possible accuracy is the best accuracy level that the machine tool can achieve. This accuracy value is normally found in the technical details of the machine tool provided by the machine tool manufacturer. However, due to various factors in a real machining environment, this accuracy is hard to attain. On the other hand, machine guaranteed accuracy is the accuracy that a machine can guarantee in a typical machining environment and process. This value may vary depending on workpiece material, workshop environment, etc. However, based on operator's experience shop-floor is able to obtain such a value for each machine tool on different types of machining operations. These values are kept in the machine tool database (refer to Section 5.5) and used by the software for decision-making. For example, if a feature has tolerances tighter than the guaranteed accuracy but less tight than the possible accuracy, this feature should be chosen to inspect. Hence, choosing different machine tools results in different process plans for machining and in-process measurement. This machine tool database can also be updated through analyzing the in-process measurement results, which effectively reflects the machine tool

performance. Table 3 shows some of the data of the machine tool database used for this research. The machine possible accuracy values are taken from the machine tool provider’s website, and the guaranteed accuracy is based on the author’s assumption and is solely used for case study purposes.

**Table 3: Machine tool database used in the case study**

| CNC Machine Tool             | Possible Accuracy (mm)                                     | Guaranteed Accuracy (mm) | Description                            |
|------------------------------|--|--------------------------|--|
| Chevalier Falcon Pro         | $\pm 0.025$  | 0.1                      | conventional 2.5-axis machine tool     |
| MAZAK NEXUS 410A             | $\pm 0.005$ [138]  | 0.02                     | 3-axis machine tool                    |
| MAZAK Vertical NEXUS 510C-HS | $\pm 0.0025$ Positional [139]                              | 0.01                     | 3-axis machine tool                    |
| MAZAK VARIAXIS 630-5X II     | $\pm 0.0025$ Positional [139]                              | 0.02                     | 5-axis machine tool                    |
| HAAS VMC – VR 11             | $\pm 0.005$ [139]  | 0.02                     | 5-axis machine tool                    |
| HAAS EC-500 w/Cluster Towers | $\pm 0.005$ Positional<br>$\pm 0.0025$ Repeatability [139] | 0.02                     | 4 w/ Thru Spindle Coolant machine tool |
| Bridgeport VMC 1000, DX-32   | $\pm 0.001$ [139]  | 0.04                     | 3-axis machine tool                    |
| Cincinnati Milacron Arrow 2  | $\pm 0.0025$ [139]   | 0.01                     | 3-axis machine tool                    |

**5.2.2. Measurement Geometry Decision Rules**

After the tolerance filtering process, critical tolerances are identified. The next step is to identify measurement geometry for each critical tolerance. An algorithm has been developed to select/create measurement geometry. The development of this algorithm starts with a meticulous investigation of GD&T definitions and their applications defined in international standards.











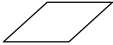



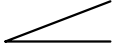

The information required for GD&T and a symbology to communicate it on a part drawing have been standardized by the ISO committee as a set of standards [140]. A similar system for GD&T has been developed into various national standards such as the National Standard of the United States of America ANSI Y14.5 [141], the German Standard DIN

7176, the British Standard BS 308 [142]. Some specifications in these national standards are deviated from those defined in the ISO 1101 standard. However, those deviations are more related to how to assign tolerances to a design. They are not considered as entirely applicable to this research. Interested readers can refer to Chapter 21 in the Handbook of Geometrical Tolerancing [142], where the deviations between ISO 1101 and ANSI Y14.5 are discussed in detail. Table 4 presents a harmonized summary of the symbols of geometric characteristics from ISO 1101 and ANSI Y 14.5.

This standardized GD&T symbology communication provides a means for specifying the shape requirements of, and the interrelationships between, part features. Because no manufacturing process can make dimensionally perfect parts, designers must specify a region to allow dimensional variations in actual parts. This region is called the tolerance zone. The traditional view of tolerancing is that when the dimensional variation is within the allowable region, the part meets shape requirements; that is, the actual part is functionally acceptable.

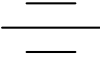
Major geometric tolerancing theories and methods for mechanical design are usually categorized as the traditional plus/minus tolerancing theory and the modern tolerance zone theory. The traditional plus/minus tolerancing method is used for specifying allowable size variation around the nominal size. The modern tolerance zone method is used not only to specify allowable size variation but allowable variations of feature form and feature interrelationships. Traditional plus/minus tolerancing provides a basis for defining the limit of size used in dimensioning mechanical parts. The size tolerance indicates the quantity of the allowable variation of a dimension, either linear or angular.

Table 4: Symbols for geometric characteristics

|                         | Type of tolerance | Characteristic                    | Symbol  | Datum needed  |
|-------------------------|-------------------|-----------------------------------|---|---|
| For individual features | Form              | Straightness                      |    | No  |
|                         |                   | Flatness                          |    | No  |
|                         |                   | Circularity (roundness)           |    | No  |
|                         |                   | Cylindricity                      |    | No  |
|                         |                   | Profile of a line                 |    | No  |
|                         |                   | Profile of a surface              |    | No  |
| For related features    | Orientation       | Angularity                        |   | Yes   |
|                         |                   | Perpendicularity                  |  | Yes   |
|                         |                   | Parallelism                       |  | Yes   |
|                         |                   | Profile of a line                 |  | Yes   |
|                         |                   | Profile of a surface              |  | Yes   |
|                         | Location          | Position                          |  | Yes or No   |
|                         |                   | Concentricity (for centre points) |  | Yes   |
|                         |                   | Coaxiality (for axes)             |  | Yes   |
|                         |                   | Symmetry                          |  | Yes   |
|                         |                   | Profile of a line                 |  | Yes   |
|                         |                   | Profile of a surface              |  | Yes   |
|                         |                   | Run-out                           | Circular run-out  |  |
|                         | Total run-out     |                                   |  | Yes   |

The advantage of this traditional tolerancing method is that it is simple for designers to use. It is also simple for inspectors to verify using a micrometer, a calliper, or a protractor. However, there are several shortcomings in this approach. Only size tolerances and simple forms of positional tolerances are supported. There is no specification for form tolerances or complex features interrelationships (including true position). As a result, assembly and alignment requirements cannot be represented or verified. Plus/minus tolerancing also lacks abstraction power in representing the tolerance of a mechanical part in CAD/CAM systems.

Modern tolerancing theory was developed to overcome shortcomings in traditional tolerancing theory. Modern geometric tolerancing methods are based on two major principles: the Maximum Material Condition (MMC) principle, also called Taylor's principle; and the Independence principle. The MMC requires an envelope which is the boundary surface of a similar perfect form of the nominal feature in the design. The envelope must totally contain the feature and must meet the shape requirements. The similar perfect feature is the feature at the maximum material size limit (the worst case). The Independence principle makes a clear distinction between size tolerance and form tolerance. It requires tolerancing for size without any reference to form or location tolerances. The latter must be defined separately, when necessary. ISO 1101 and ASME Y14.5 are based on the MMC principle.

A tolerance zone is a virtual region formed around the true feature [141]. Tolerances of orientation and location define zones within which all points of the toleranced feature have to be contained. Therefore, related geometrical tolerances also contain form deviation (Figure 53). Related geometrical tolerances of axes or median faces, limit the form deviations of the axes or median faces, but not of the pertinent surfaces. The indication of form tolerances is not necessary when the related geometrical tolerance already limits the form deviations. Similarly, locational tolerances limit the location but also the orientation and the form of the toleranced feature.



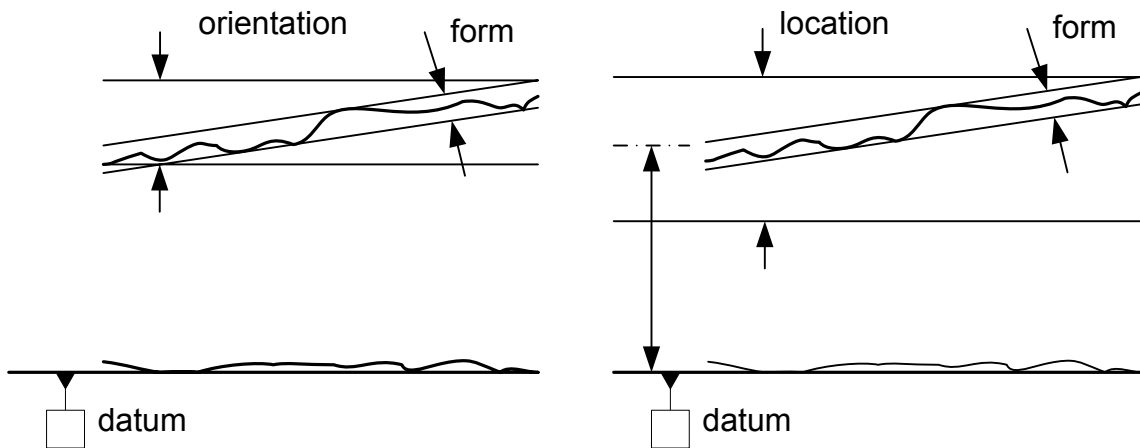

**Figure 53: Form deviation, orientational deviation, and locational deviation**

When applying a tolerance to the design, the tolerance symbol together with the tolerance frame are connected to the toleranced feature. The symbol indicates which type of tolerance it is. The information in the tolerance frame indicates the datum reference for the applied tolerance. As introduced in Chapter 4, fourteen types of geometric tolerances, twelve type of dimensional tolerances, and the tolerance related datum reference information are defined in the proposed STEP data model. The proposed data model also establishes the mechanism to link any two of the following elements: machining operation, workingstep, machining features, and tolerance. Figure 54 depicts the relationship between these elements. It is shown that a machining workingstep has its corresponding machining operation and machining feature. A machining feature has one or more machining operations. It is also possible (optional choice indicated by dotted line in Figure 54) to have tolerances.

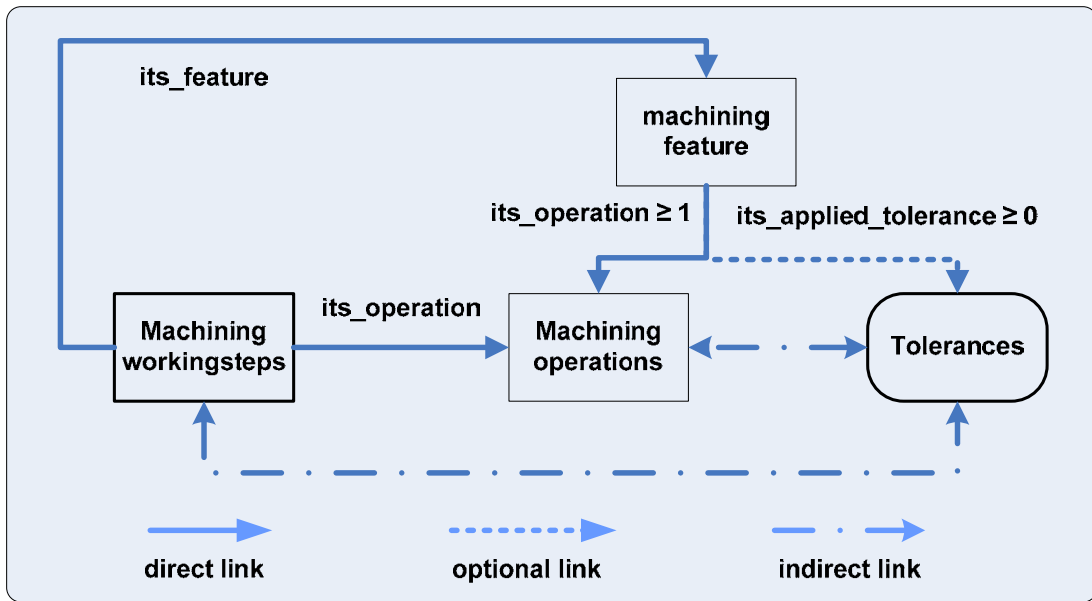

Figure 54: Information linkage between machining, tolerance, and features

In this way, the link between tolerance requirement, machining operation and workingsteps is setup indirectly. Therefore, the correspondence between each critical tolerance and its associated machining feature can be obtained from the input data file. It is necessary to clarify that a machining feature is not an inspection feature, nor a measurement geometry. For instance, an open pocket is a machining feature (Figure 55). If a symmetry tolerance is applied to the two walls of the pocket, the geometry to measure is each of these two planes.

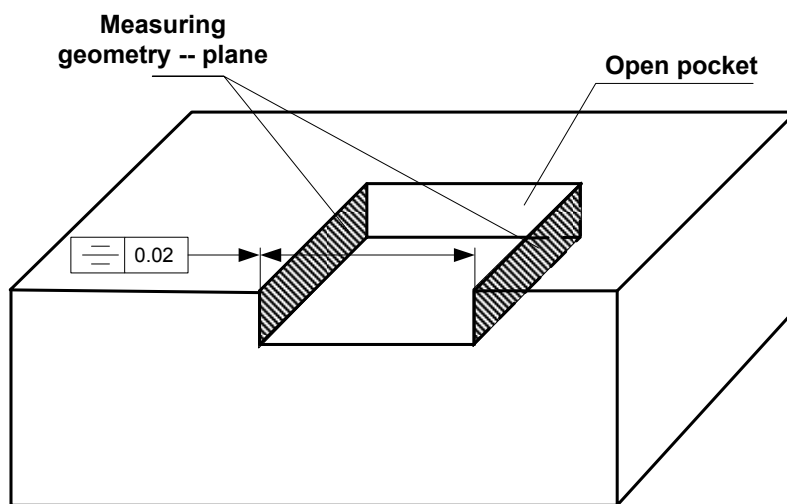
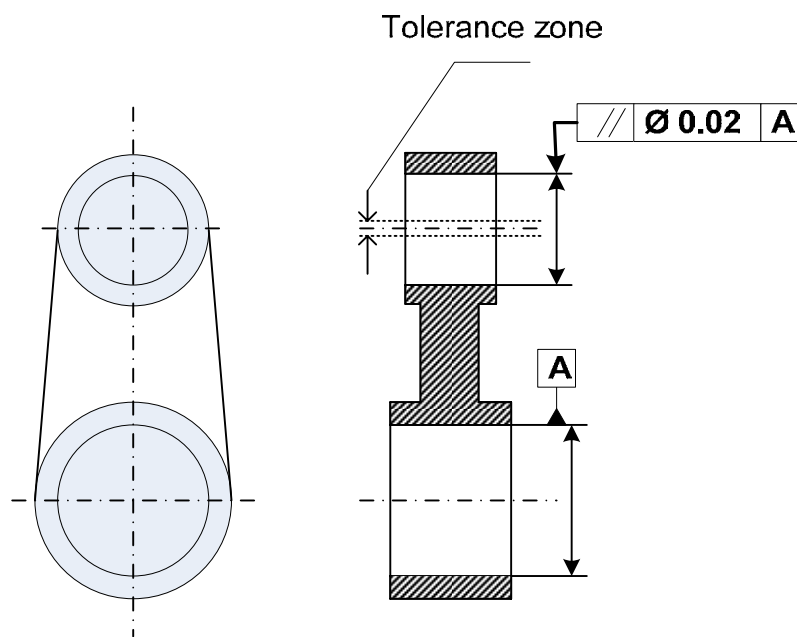

Figure 55: Difference between a machining feature and a measurement geometry

With this information, the measurement geometry decision algorithm can trace which tolerance is applied to which machining feature, and which toleranced geometry the tolerance is applied to. However, the toleranced geometry may not always be the measurement geometry. Considering the part in Figure 56, the parallelism tolerance is applied to a cylinder to control the cylinder axis. In the STEP input data file, the toleranced geometry is a line since the tolerance is to control the position of the axis, but in order to inspect this tolerance, the cylinder has to be the measurement geometry.



**Figure 56: Parallelism tolerance of a cylinder axis**

As defined in ISO 1101 and ANSI Y14.5, each type of geometric tolerance can be employed to control certain geometry characteristics. This research summarized the applications of geometric tolerances (which is the main focus of this research). However, it is important to clarify the two limitations that this research has,

- 1) MMC principle has not been properly modelled in STEP/STEP-NC standards, therefore, it is not considered in this research.
- 2) Profile tolerances and run-out tolerances are commonly used for workpiece machined by 5-axis machines and turning machine, respectively. Therefore, this research does not consider these tolerances.

### **5.2.2.1. Form Tolerances**

Form tolerances are applicable to single (individual) features or elements of a single feature; therefore, form tolerances are not related to datum. Form tolerances include straightness, flatness, circularity, and cylindricity. This type of tolerance can be used for two distinctly different controls.

1) Surface control

When used as a surface control, the tolerance zone is considered the distance between two parallel lines or planes, within which the controlled line or surface must fall.

2) Control of derived median planes or derived median lines.

When used as derived median line or plane control, the tolerance zone begins as cylindrical in shape and runs through the feature's centre. The controlled feature's derived median line must lie within this tolerance zone. This derived median line, which is generated by the controlled feature's surface, must never violate this cylindrical tolerance zone. When used as the derived median planes control, the tolerance zone is the distance between two perfectly flat parallel planes within which the derived median plane must reside.

Straightness can be used for both geometric controls and for both cylindrical and planar surfaces. Flatness can also be used for both geometric controls but is applicable only for planar surfaces. Understandably, circularity and cylindricity are applicable only to cylindrical surfaces.

### **5.2.2.2. Orientation Tolerances**

Orientation tolerances include angularity, parallelism, and perpendicularity. In some instances, profile tolerances may also be orientation tolerances when applied to related features. These tolerances control the orientation of a feature relevant to another. Therefore, datum features are required. These tolerances may be related to one or more

datum features. Orientation tolerances are able to specify one of the following geometric characteristic controls.

- 1) A tolerance zone defined by two parallel planes parallel to a datum plane or axis, within which the surface or centre plane of the considered feature must lie.
- 2) A tolerance zone defined by two parallel planes parallel to a datum plane or axis, within which the axis of the considered feature must lie.
- 3) A cylindrical tolerance zone parallel to one or more datum planes or a datum axis, within which the axis of the feature must lie.
- 4) A tolerance zone defined by two parallel lines parallel to a datum plane or axis, within which the line element of the surface must lie.

### **5.2.2.3. Location Tolerances**

Location tolerances limit the deviations of a feature from its geometrical ideal location (orientation and distance) with respect to the datum. The location tolerances limit also the orientation deviation and the form deviation of the tolerated feature (plane surface, axis or median face), but not the form deviation of the datum features. Location tolerances include position, concentricity, and symmetry tolerances, and they are used to control the following relationships.

- 1) Centre distance between such features as holes, slots, bosses, and tabs
- 2) Location of features as a group, from datum features, such as plane and cylindrical surfaces
- 3) Coaxiality of features
- 4) Concentricity or symmetry of features—centre distance of correspondingly-located feature elements equally disposed about a datum axis or plane

Position tolerances define a tolerance zone within which the centre, axis, or centre plane of a feature of size is permitted to vary from a true (theoretically exact) position. As an example, Figure 57 illustrates a position tolerance used to control the position of symmetry features. The centre plane of the slot must lie between two parallel planes 0.8 apart and equally disposed about the centre plane of datum B. Figure 58 illustrates a symmetry tolerance applied on the same slot.

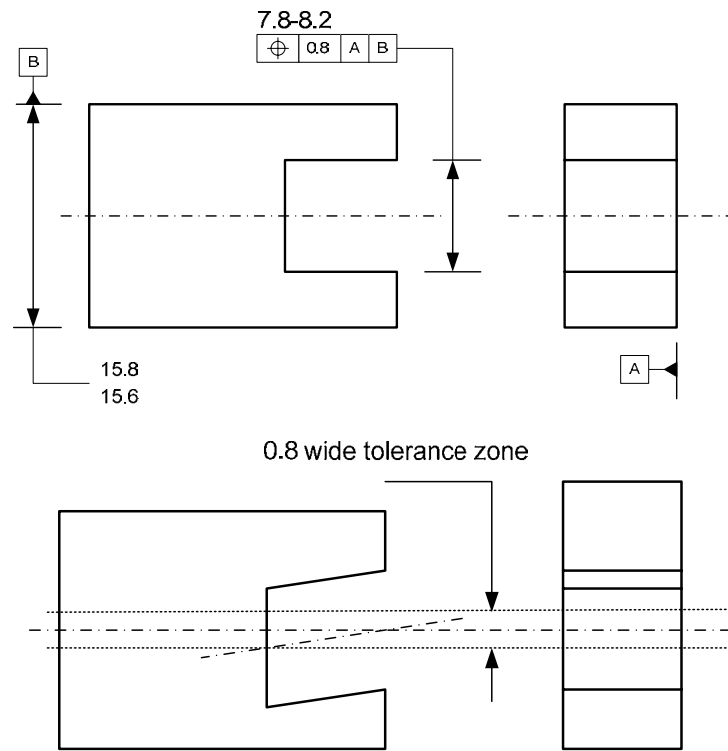

Figure 57: Positional tolerancing for symmetrical features

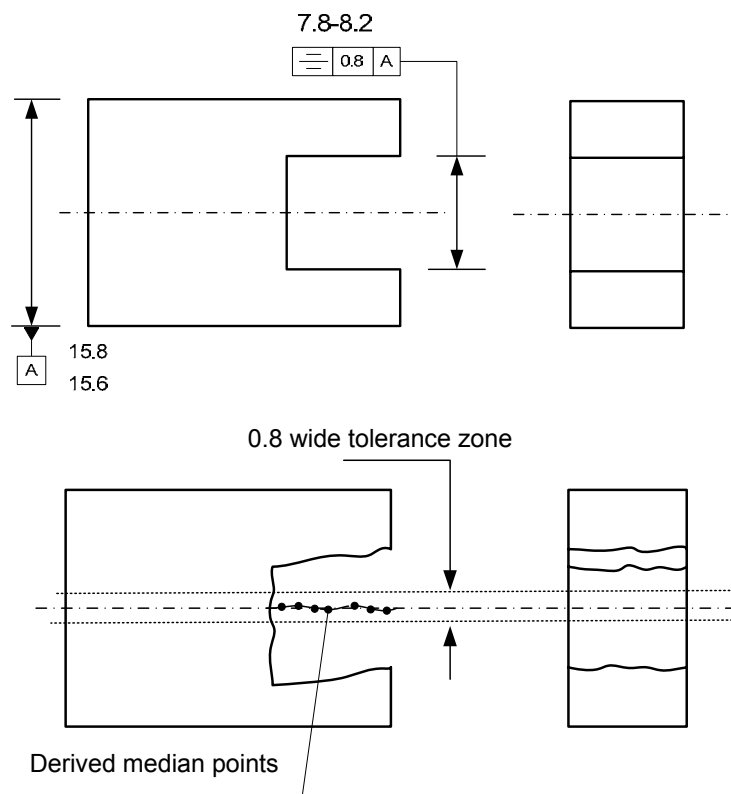

Figure 58: Symmetry tolerancing for symmetrical features

Within the limits of size and regardless of feature size, all median points of opposed elements of the slot must lie between two parallel planes 0.8 apart. The two planes are equally disposed about datum plane A.

From the above analysis of form, orientation, and location tolerances, a decision-making algorithm was developed in this research. The flowchart of this algorithm for geometric tolerances is shown in Figure 59. The algorithm first parses the tolerance information from a data file. Then, it traces the tolerance related features. Together with toleranced geometry information, the algorithm is able to decide what geometry to measure on the toleranced feature. For example, if a position tolerance is applied to a pocket feature, it is categorised in the algorithm as case 8. If the toleranced geometry is not one of the planes on the pocket, then this position tolerance is used to control a median plane, which is case 8-2 in the algorithm. From the location and orientation information of the toleranced plane and the pocket (provided in the STEP file), the algorithm is able to select the two planes that need to be inspected. Although this research focuses on geometric tolerances, basic dimensional tolerances are also considered. The principle of selecting/creating measurement geometry for dimensional toleranced features is the same as that for geometric tolerances.

Figure 60 illustrates how the information is traced from a given STEP file for both geometric and dimensional toleranced features. The selected tolerance is checked first by its type. For example, if the critical tolerance is a width size tolerance, i.e. a type of dimensional tolerance, it is categorized in the algorithm as case 6 under the dimensional tolerance category. Then, the tolerance related machining feature is checked to obtain the measurement geometry. For the width size tolerance, it may be applied to a plane or a line. When a machining feature has critical tolerance(s) applied to, the corresponding measurement geometry is selected. If a tolerance is applied on a median plane or axis, the feature where the median plane or axis originated from is obtained first.

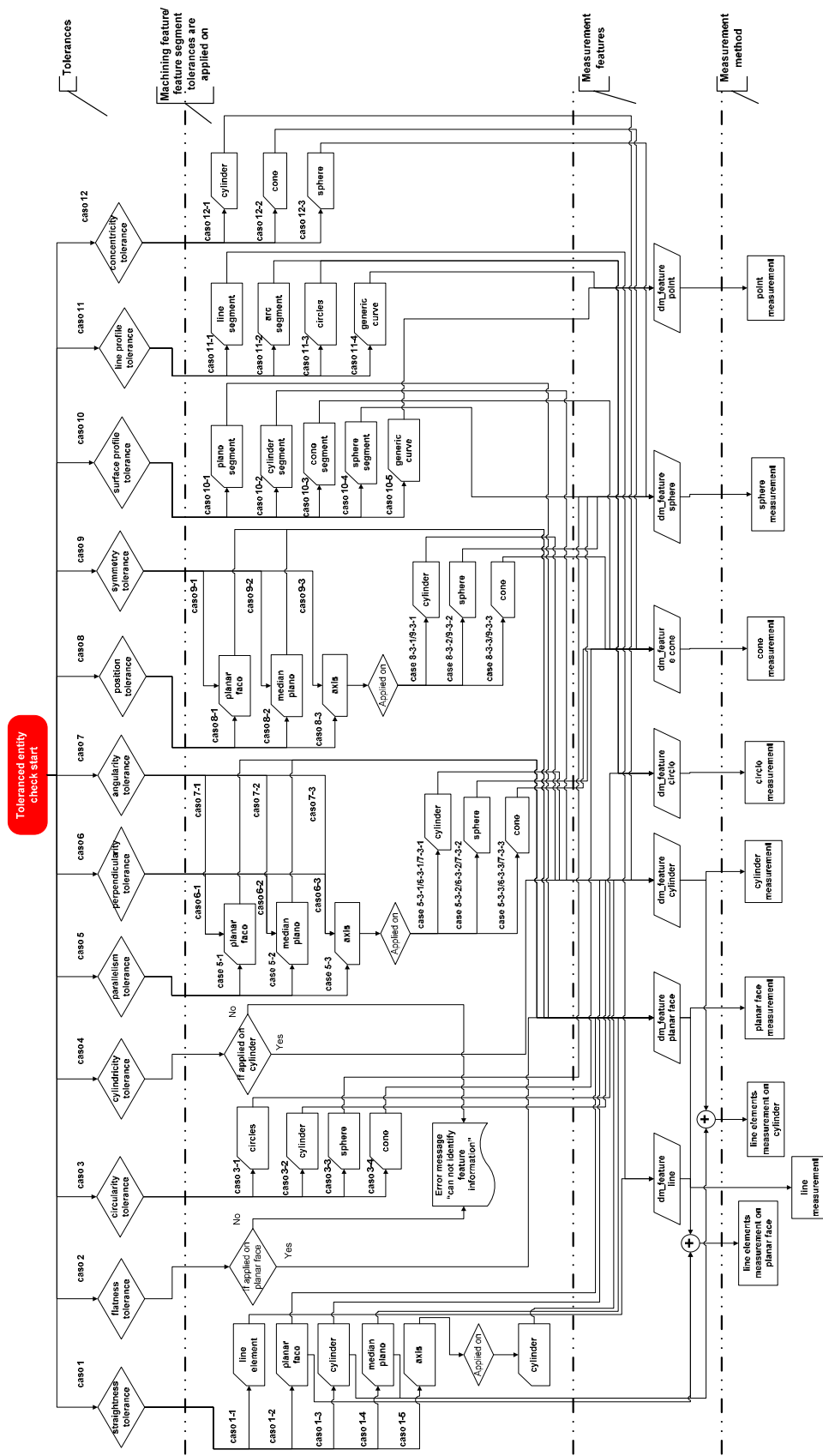

Figure 59: Measurement geometry decision making algorithm



Then, the associated measurement geometry is decided from this feature. Among the fourteen types of geometric tolerances, seven of them have been tested in the case studies. Two types of dimensional tolerances are tested in the case studies as well (refer to Chapter 6). After each selected critical tolerance is processed through this algorithm, a set of measurement geometry is generated. The next step is to insert measurement operations of the geometry in-between machining operations.

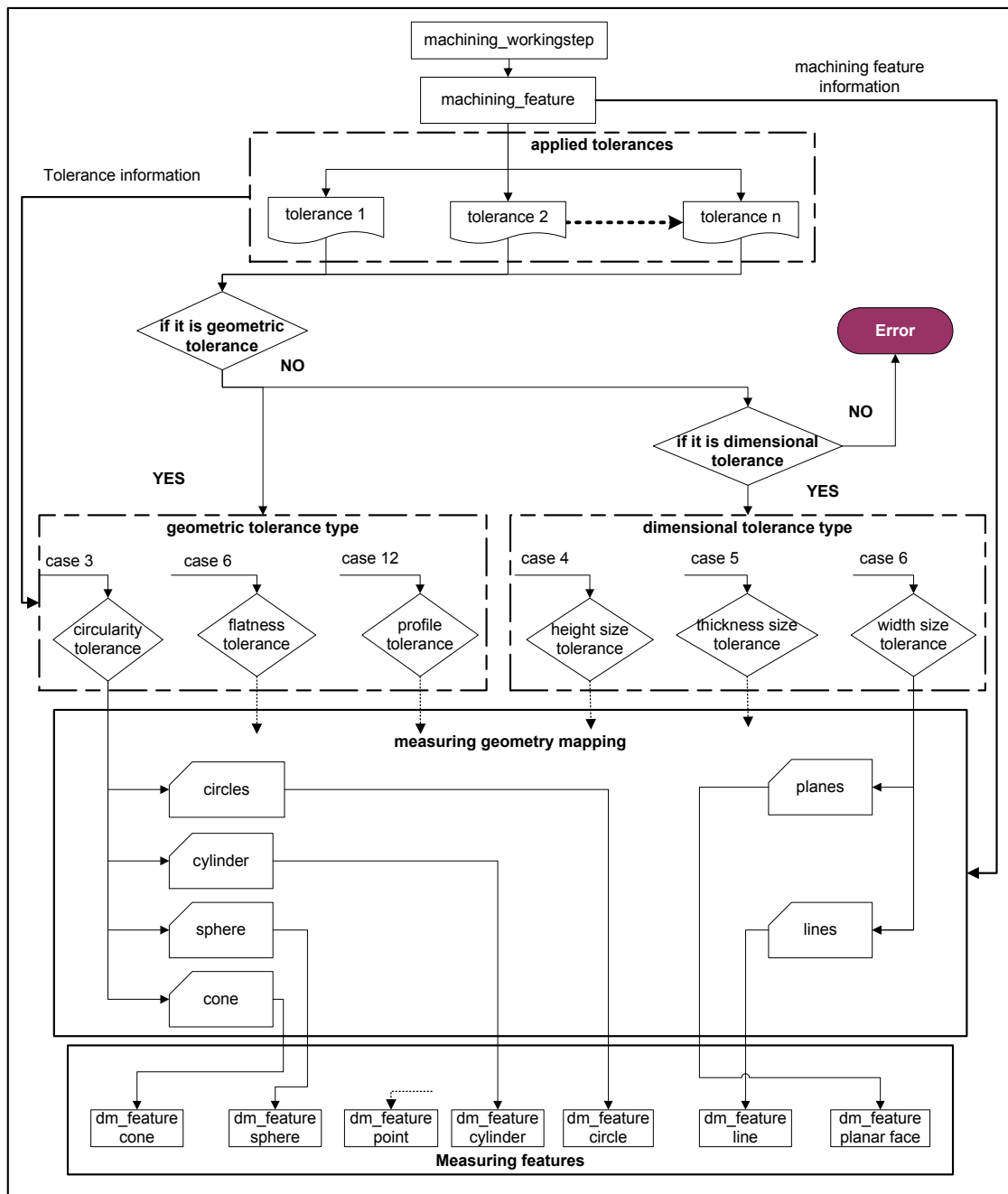

Figure 60: Measurement geometry selection algorithm

### 5.3. Workingstep Re-sequencing

Each machining feature may need more than one machining operation to produce (Figure 54), such as multiple roughing operations and finishing operations. If a machining feature has critical tolerances applied to it, it is often necessary to inspect this feature during the machining processes. The workingstep re-sequence system makes decisions on when to carry out the measurement operation in-between the machining operations and then assigns an appropriate measurement device for the measurement operation.

Since the proposed integrated process planning system intends to use limited inspection operations for a more controlled machining process, measurement operations are only planned for critical tolerances after critical machining operations. Also due to the delicate nature of measurement devices, it is not suitable to perform measurement on a rough surface.

In previous research [1], the authors have identified four types of inspection operation in manufacturing processes.

➤ INSPECTION TYPE I

These are set-up inspections carried out prior to machining operations. This type of inspection is needed to provide the positional and dimensional information of the workpiece to the CNC controller so that the controller knows the exact location of the workpiece.

➤ INSPECTION TYPE II

These are final inspections to ensure that the planned operations have been successfully and accurately executed.

➤ INSPECTION TYPE III

These inspections are carried out during the machining process. This type of inspection is necessary to detect any abnormality on the workpiece or the tools, so that the controller can make changes in time. At what stage the inspection should

be carried out during the machining process depends on the requirement of the workpiece. Parts that have very tight tolerances may need additional inspections in the machining processes, whereas parts that have looser tolerances may not need inspection at all.

### ➤ INSPECTION TYPE IV

This type of inspection is necessary for multiple setups. In this situation, inspections are necessary in each setup to provide accurate workpiece location information and new reference information after the previous machining operations.

It is natural to carry out setup inspection (INSPECTION TYPE I) before machining process starts. The implementation software prototype in this research (refer to Chapter 6) allows the operator to decide whether or not to use this integrated process planning system to generate setup inspection operation. If the operator chooses to have setup inspection, the system inserts setup measurement operations before machining operations, in-process OMM measurement operations (INSPECTION TYPE III) are inserted after semi-finishing operations for each machining feature that are selected to be monitored during machining process. If a machining feature has a very tight tolerance, it may require several semi-finishing operations. In this case, machine accuracy and machine repeatability are taken into account to decide where a measurement operation is needed. For a more accurate machine tool, however, it is perhaps only necessary to measure before the final finishing operation is carried out.

Once measurement operations are inserted in-between machining operations, it is then a measuring device is selected. The measuring device information is stored in the same file as the machine cutter information. It is common to use the same measuring tool for all of the measuring devices. However, depending on the location of measurement geometry, it may be necessary to select a measuring tool with longer tool length offset so as to be able to reach the geometry.

This research also considered the finishing inspection operations (INSPECTION TYPE II). The implementation software prototype allows operator to choose whether or not to use the

integrated process planning system to generate finishing inspection after each machining feature is produced. If a finishing inspection is chosen, measurement operation is inserted after the finishing operation.

After the workingstep re-sequence system, the output is a new STEP Part 21 file that has a workplan with a new sequence of workingsteps including machining and inspection workingsteps. Then, micro-level process planning is carried out for each machining and inspection workingsteps. This research only focuses on developing the micro inspection process planning system.

## **5.4. Micro Inspection Process Planning**

In the micro inspection process planning system, measurement for each geometry is planned. There are four steps involved in micro inspection process planning as shown in Figure 51. Firstly, the number of points and their even distribution are decided. Then, feature interaction of the measurement geometry is checked. If there is feature interaction, the third step is to reallocate the measurement points. Those measurement points located on non-existing surface are reallocated onto solid surfaces. The final step is to sequence these points based on the Travelling Sales Person (TSP) algorithm so that the shortest route covering all measurement points is generated. This section describes the above four steps in detail.

### **5.4.1. Measurement Points Generation and Distribution**

In this research, the proposed methods for deciding the number of measurement points for each geometry are developed based on British Standard (BS) 7172 [143]. As it is shown in Table 5, the minimum number of measurement points for each basic type of geometry is different from the mathematical number that is used to create the geometry. This BS standard suggested minimum measurement points for each geometry. For example, in the implementation software prototype (STEP-INSPEC), to measure a plane the minimum number of measurement points for any plane surface is ten. However, this can easily be modified to suit different levels of tolerance tightness in future research.

The distribution of measurement points should aim for a uniform coverage of the concerned entity. This helps ensure that the points provide a genuine representation of the toleranced feature. However, the distribution should not be so regular that it may follow systematic or periodic deformations. For each type of the above geometry, the standard recommends specific methods to distribute measurement points. These methods are used in this research.

**Table 5: Minimum number of measurement points on each basic features [143]**

| Element  | Minimum number of points |             | Comment   |
|----------|--------------------------|-------------|---|
|          | mathematical             | recommended |   |
| Line     | 2                        | 5           |   |
| Plane    | 3                        | 9           | Approximately three lines of three                              |
| Circle   | 3                        | 7           | To detect up to six lobes                                       |
| Sphere   | 4                        | 9           | Approximately three circles of three in parallel planes         |
| Cylinder | 5                        | 12          | Circles in four parallel planes for information on straightness |
|          |                          | 15          | Five points on each circles for information on roundness        |
| Cone     | 6                        | 12          | Circles in four parallel planes for information on straightness |
|          |                          | 15          | Five points on each circle for information on roundness         |

As an example, to achieve a nearly uniform distribution of  $N$  points on a rectangular segment of a plane, the rectangle should be divided into  $N_1 \times N_2$  sub-rectangles by a regular mesh of lines, where  $N_1$  and  $N_2$  is approximately equal to  $N$ , and one point placed in each sub-rectangle (Figure 61). The sub-rectangles should be as close to a square as possible. In the STEP-NC standard, a planar face is defined as follows.

```

ENTITY planar_face
  SUBTYPE OF (machining_feature);
  course_of_travel      : linear_path;
  removal_boundary     : linear_profile;
  face_boundary        : OPTIONAL closed_profile;
  its_boss              : SET [0:?] OF boss;
END_ENTITY;

```

From the attributes `course_of_travel` and `removal_boundary`, the length and width of the plane can be obtained. The size value is then used to decide the length and width of the sub-rectangles for distributing measurement points.

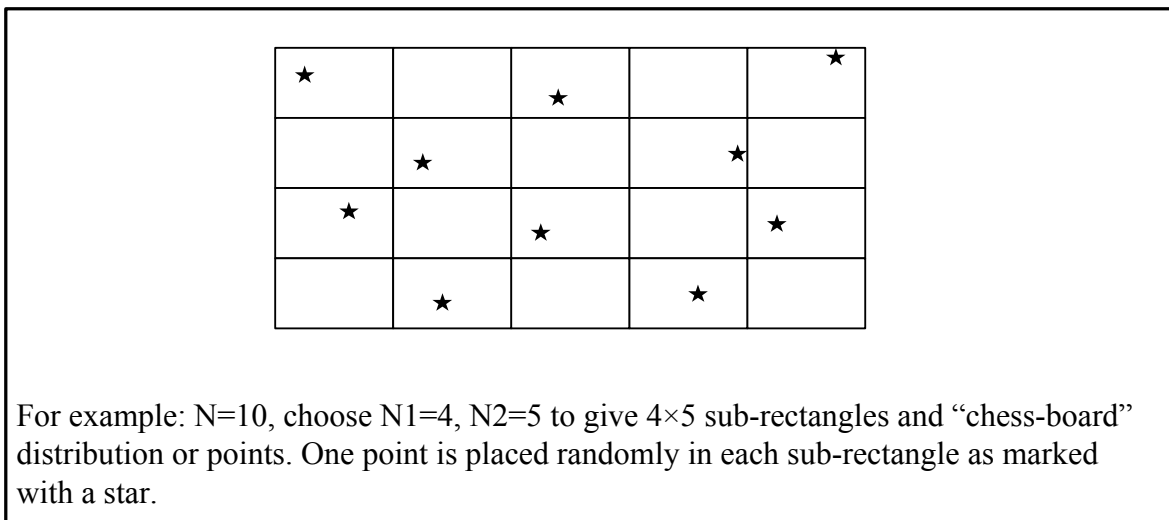

**Figure 61: Distribution of points on rectangular plane**

As another example, to achieve a nearly uniform distribution of  $N$  points on a cylinder of height  $h$  (Figure 62) and radius  $r$  is similar to producing a nearly uniform distribution of  $N$  points on a rectangular plane segment of length  $h$  and breadth  $2\pi r$ . Thus, the distribution for such a plane, as given previously, may be used for the cylinder by “wrapping the plane around the cylinder”. Alternatively, the points can be placed on parallel circles on the cylinders. The circles are roughly uniformly spaced. This method is used in this research.

$n_c$  represents the number of circles. It should be determined as an integer close to  $\sqrt{\frac{Nh}{2\pi r}}$ .

$n_p$  represents the number of points on each circle. It should be determined as an integer close to  $N/n_c$ . For each  $n_c$ , approximately uniformly spaced planes interact with the

cylinder perpendicular to the cylinder's axis. The interaction produces  $n_c$  circles on the cylinder. On each circle,  $n_p$  approximately uniformly spaced measurements should be taken.

It should be beneficial for the number of points to alternate between odd and even on the circles. Take the case shown in Figure 62 as an example, seven points on the first, eight on the second, seven on the third, etc. If straightness of the cylinder is of importance, more circles should be used with fewer points on each. If circularity of the cross section is of more importance, more points on each circle should be used. .

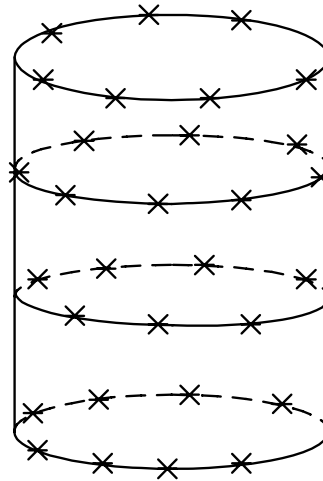

Figure 62: A distribution of points on a cylinder

In the STEP-NC standard, a round\_hole (cylinder) was defined as (Figure 63) :

```
ENTITY machining_feature
  ABSTRACT SUPERTYPE OF (ONEOF(planar_face,
                                pocket,
                                slot,
                                step,
                                round_hole,
                                toolpath_feature,
                                profile_feature,
                                boss,
                                spherical_cap,
                                rounded_end,
                                thread))
  SUBTYPE OF (two5D_manufacturing_feature);
  depth : elementary_surface;
END_ENTITY;
```

```

ENTITY round_hole
  SUBTYPE OF (machining_feature);
  diameter      : toleranced_length_measure;
  change_in_diameter : OPTIONAL taper_select;
  bottom_condition : hole_bottom_condition;
END_ENTITY;

```

From attributes `change_in_diameter` and `bottom_condition`, it is possible to identify what type of hole it is. If it is a cylindrical shape, then the diameter is obtained from this entity. The height of this cylinder can be obtained from its supertype `machining_feature`, which has an attribute called `depth` to hold the information for the cylinder height. Then, following the distribution method, the coordinates of each measurement point for inspecting this cylinder are determined. The measurement points distribution methods for cone, sphere, and circle are also implemented.

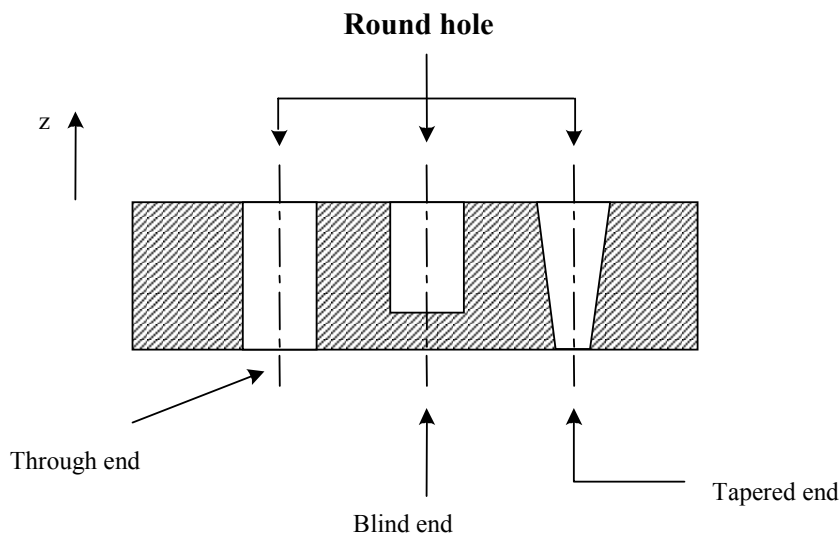

Figure 63: Round hole defined in STEP-NC standard [118]

#### 5.4.2. Feature Interaction Detection

After the number of measurement points and allocation of these points are decided, feature interaction detection is carried out. The purpose of this process is to detect whether there is any feature interaction between the measurement geometry and other features. For example, a flatness tolerance is applied to the top surface of the workpiece where a pocket feature is also located (Figure 64). When measurement points are generated for this plane, some of the points may locate in the virtual surface instead of a solid one (indicated as



feature interaction zone in Figure 64). It is necessary to reallocate these points to solid surface. The method developed in this research is closely related to the feature definitions in STEP/STEP-NC standards.

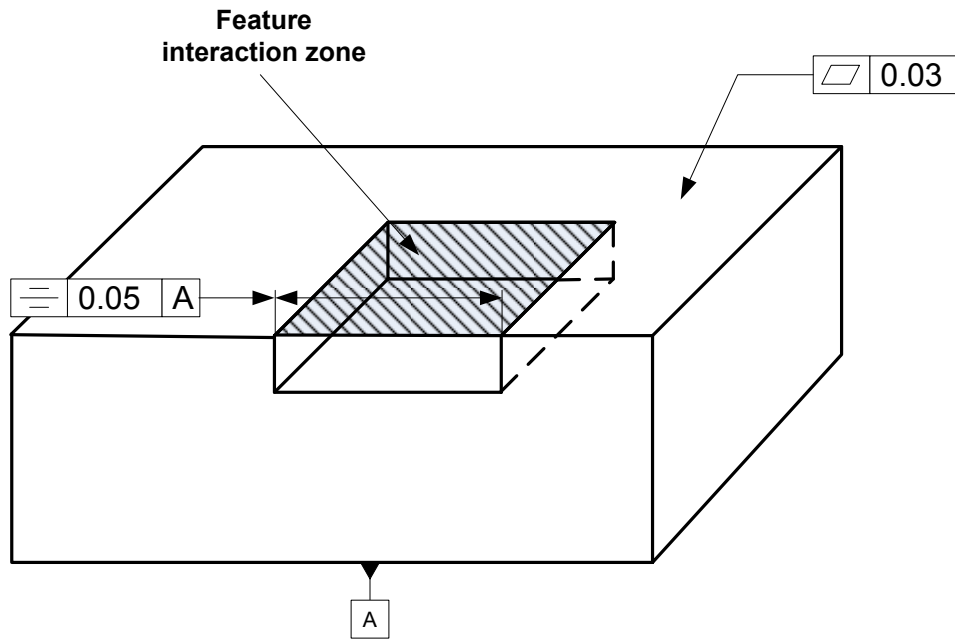

Figure 64: Illustration of feature interaction

In STEP/STEP-NC, each two5D\_manufacturing\_feature has its feature location and depth plane to define the location and depth of the feature. Different features also have different attributes to define the shape of the feature. For example, a closed pocket feature has orthogonal\_radius to define the orthogonal radius fillet. It also has feature\_boundary (which is a closed\_profile) to define the shape of the pocket. This closed\_profile can be a rectangular\_closed\_profile, circular\_closed\_profile, ngon\_profile, or general\_closed\_profile. The EXPRESS schema of these entities are given below.

```
ENTITY two5D_manufacturing_feature
  ABSTRACT SUPERTYPE OF (ONEOF(machining_feature,
  replicate_feature,
  compound_feature))
  SUBTYPE OF (manufacturing_feature);
  feature_placement      : axis2_placement_3d;
  its_applied_tolerance  : OPTIONAL SET [0:?] OF tolerance;
END_ENTITY;
```

```

ENTITY pocket
  ABSTRACT SUPERTYPE OF (ONEOF(closed_pocket, open_pocket))
  SUBTYPE OF (machining_feature);
  its_boss          : SET [0:?] OF boss;
  slope            : OPTIONAL plane_angle_measure;
  bottom_condition : pocket_bottom_condition;
  planar_radius    : OPTIONAL toleranced_length_measure;
  orthogonal_radius : OPTIONAL toleranced_length_measure;
END_ENTITY;

ENTITY closed_pocket
  SUBTYPE OF (pocket);
  feature_boundary : closed_profile;
END_ENTITY;

ENTITY closed_profile
  ABSTRACT SUPERTYPE OF (ONEOF (rectangular_closed_profile,
                                circular_closed_profile,
                                ngon_profile,
                                general_closed_profile))
  SUBTYPE OF (profile);
END_ENTITY;

```

Based on the shape, location, and depth information of a pocket, the outside space of this pocket can be divided into seven sections (Figure 65). All other features on the same workpiece are then looped through in the feature interaction detection algorithm. The locations of the detecting feature (the feature that is compared with the closed pocket) is first checked to see if it is located in one of the 7 zones. If the feature is located in zone 1, it is considered to be interacting with the closed pocket as a nesting interaction (a feature is located inside another feature). If the feature is located in zone 2, it does not interact with the closed pocket. If the feature location is in zones 3 – 7, it may interact with the closed pocket and further checking is necessary. The further checking is related to the type of the detecting feature. The algorithm is shown in Figure 67. For example, if the detecting feature locates in zone 3 and is a slot feature, the length, width, and the coordinates of the slot are taken into account by the algorithm to decide whether it interacts with the closed pocket.

For different features, divisions of non interaction zone, possible interaction zone, and interaction zone are different. As shown in Figure 66, a step feature is defined in STEP/STEP-NC as a volume of material removed from the top and the sides of the workpiece. Therefore, the space around a step feature can be divided into non interaction zone and interaction zone.

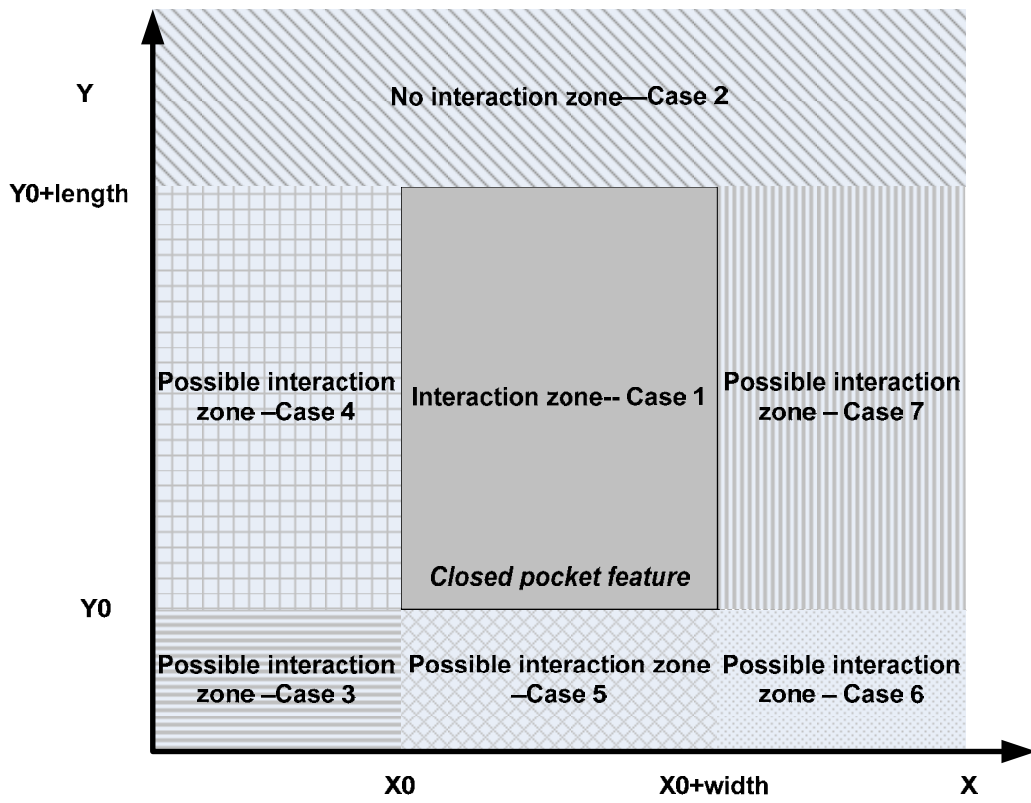

Figure 65: Feature interaction detection zones for closed pocket feature

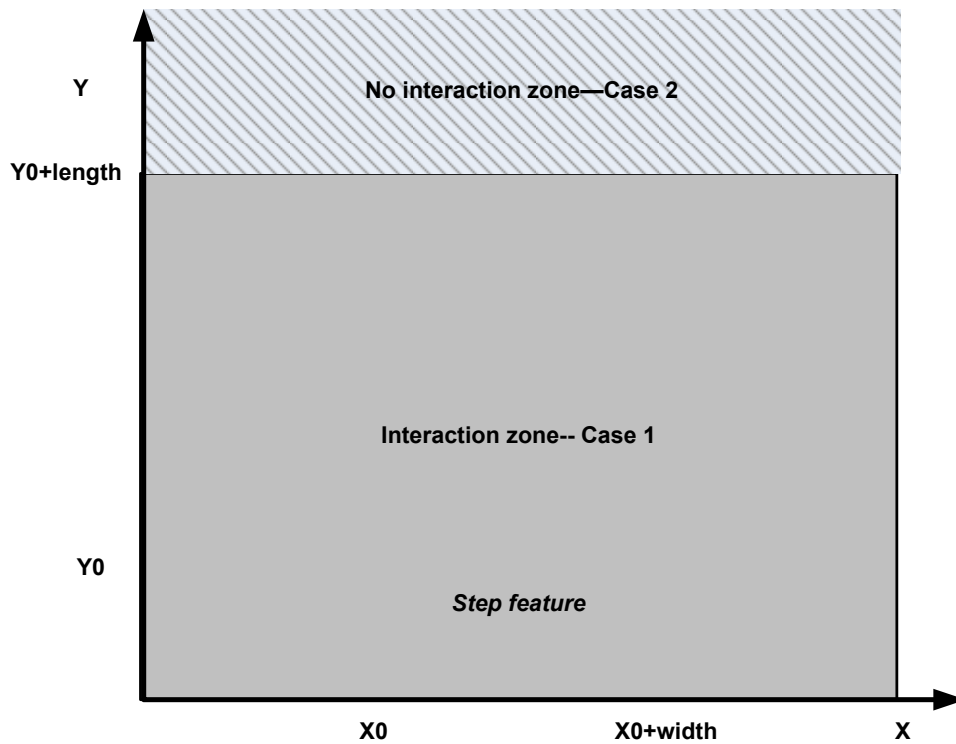

Figure 66: Feature interaction zones for step feature

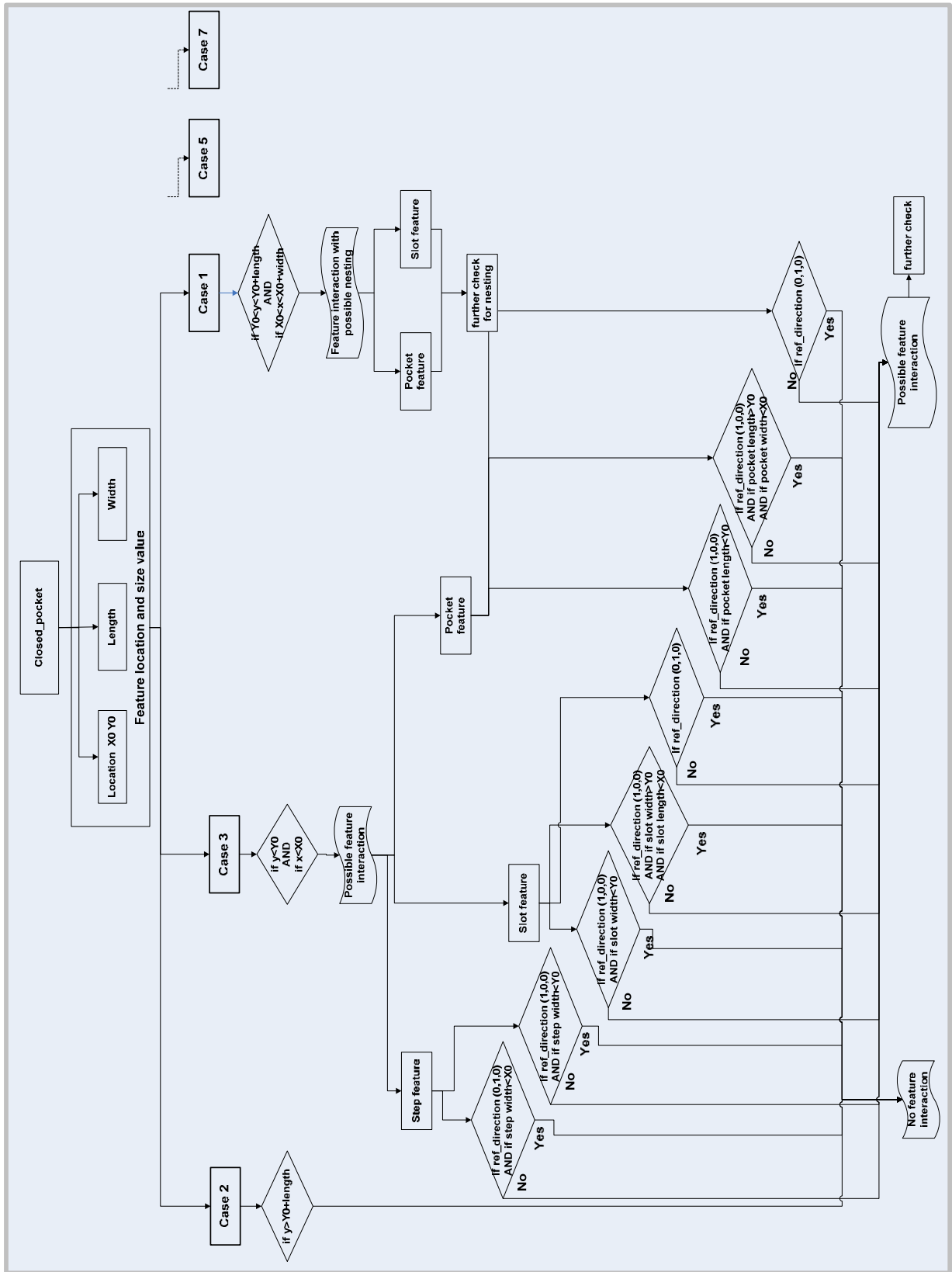

Figure 67: Feature interaction detection algorithm flowchart for closed pocket feature

Obviously, this algorithm has restrictions on the type of features and where to assign the feature location to the detecting feature. This algorithm is applicable only to regular shape features. It is required that feature location (the origin of the feature coordinate system) be situated at the left bottom corner of the feature. This feature detection algorithm is to be further developed and tested in future research.

### **5.4.3. Measurement Points Reallocation and Re-sequence**

If feature interaction is detected for the measurement geometry, all measurement points are checked through the measurement points reallocation algorithm. The proposed algorithm consists of two parts as shown in Figure 68. During the feature interaction detection process, feature interaction information (the points where two features interact with each other) is kept and passed to this algorithm. The interacting area is then recalculated to generate a polygon shape through the interacting area calculation.

Then, each measurement point generated from the measurement points decision and distribution process is processed through the point-in-polygon detection algorithm to check if the point is inside the polygon. If the point is in the polygon, this point is deleted from the measurement point list, and the algorithm calls the measurement points generation function to generate a new measurement point. This process continues until all points are outside the interacting polygon.

The final step of the micro inspection process planning system is to re-sequence the measurement points. TSP algorithm is employed to achieve this. TSP itself is not the focus of this research. Therefore, a TSP program by Konstantin Boukreev [144] was used and integrated in the STEP-INSPEC software for the purpose of sequencing the probing points.

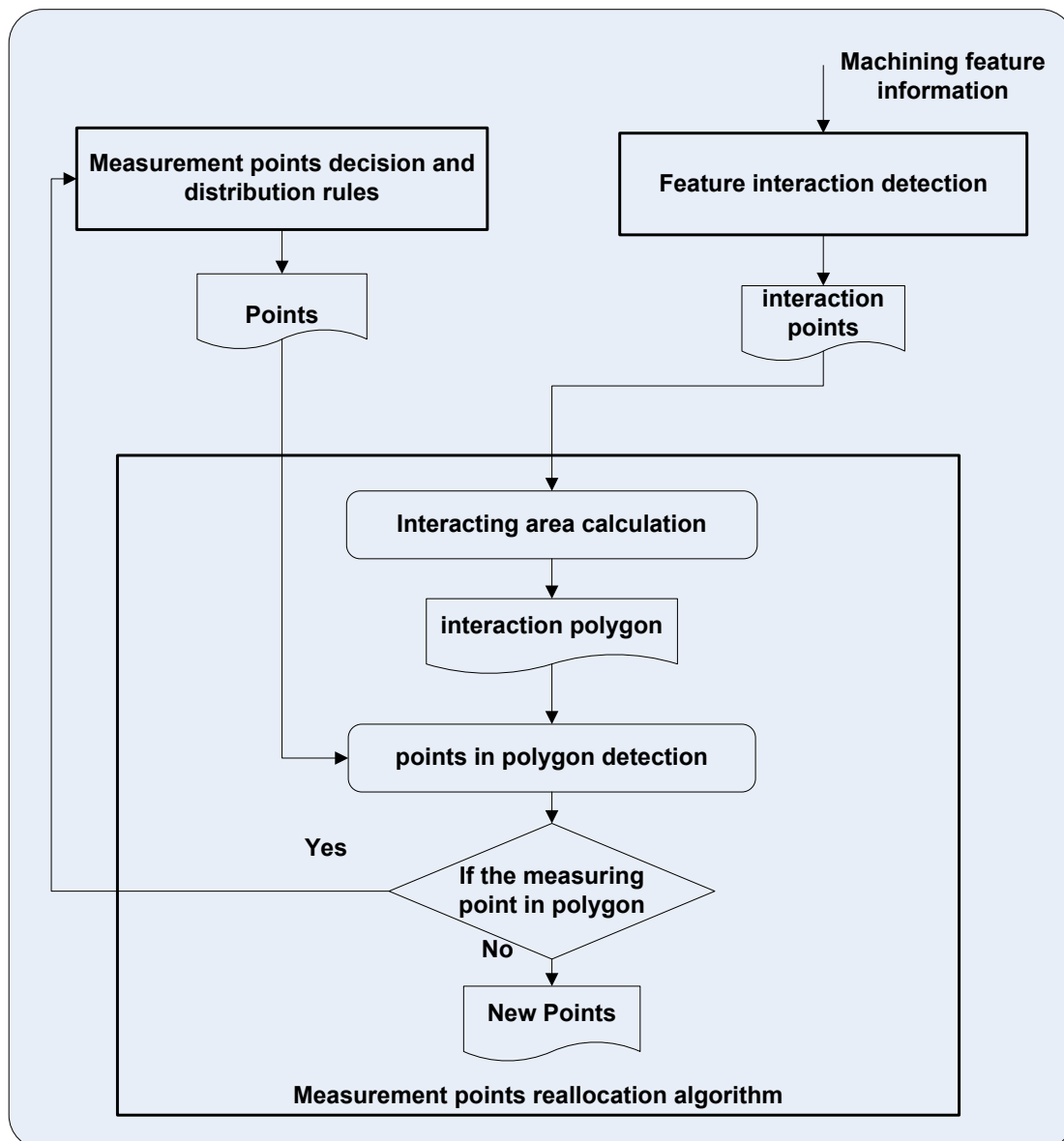

Figure 68: Measurement points reallocation algorithm

## 5.5. Measurement Result Analysis and Feedback

The micro-level inspection and machining process planning system generates measurement and machining commands for the CNC machine to execute. After each in-process measurement operation is executed, measurement results are fed into the measurement result analysis and feedback system, where data fitting algorithms are employed to reconstruct the machined geometry from the measured points. Then, the generated geometry is compared with tolerance zone requirements. Necessary updates are passed to

subsequent machining operations for compensation or adjustment. This section describes the data fitting algorithms, tolerance zone analysis method, and feedback update process in this research.

### 5.5.1. Data Fitting Algorithms

Data fitting algorithms are also called data reduction methods. The purpose of using fitting algorithms is to extract feature parameters that can best represent the actual part dimensions and tolerances. The challenge in designing a fitting algorithm is how to best approximate (with certain criteria) the actual geometry of manufactured features.

BS 7172:1989 [143] recommended that the assessment process should be carried out in four stages:

- 1) apply an appropriate measurement procedure, i.e. a strategy for obtaining a representative set of measurements on the workpiece;
- 2) (optionally) pre-process the data, i.e. replace the measured data by modified values in order, for example, to smooth the data, to remove inappropriate points or to compensate for environmental effects;
- 3) compute the reference (e.g. an approximating circle in terms of its centre coordinates and radius), to give position and size;
- 4) assess, in terms of the reference, the departure from nominal form.

The first stage is carried out in the micro inspection process planning system. The second stage is not implemented in this research since the measurement process is still in simulation stage. It is necessary to implement this once the implemented software prototype is connected with real machine tool and probing devices. Stages 3 and 4 are implemented in the implementation software prototype for data fitting.

#### 5.5.1.1. *Mathematical Representation of Geometric Elements*

In order to obtain a reliable assessment of a geometric form in any particular case, the corresponding geometric element should first be represented, i.e. parameterized, by a set of measured data points in a Cartesian coordinate system in a mathematically sound way. It is

possible to parameterize each of the geometric elements in more than one way. The parameterizations given in BS 7172:1989 [143] are recommended as being generally applicable. In this research, the mathematical representation of planes, circles, and cylinders are implemented.

A plane should be specified by a point on the plane and either of the following two items.

- 1) The direction cosines of the normal to the plane

A plane P, related to a set of data points, should be specified by:

- (i) a point  $(x_0, y_0, z_0)$  on P; and
- (ii) the direction cosines (a, b, c) of the normal to P.

Point  $(x_0, y_0, z_0)$  should be taken at or near G, the point on P closest to the centroid of the data points. Any point  $(x, y, z)$  on P satisfies the equation:

$$a(x-x_0) + b(y-y_0) + c(z-z_0) = 0 \quad (5-1)$$

- 2) a point on the normal to the plane passing through the first point.

A plane P, related to a set of data points, should be specified by:

- (i) a point  $(x_0, y_0, z_0)$  on P; and
- (ii) a point  $(x_1, y_1, z_1)$  on the normal to P at  $(x_0, y_0, z_0)$ .

Point  $(x_0, y_0, z_0)$  should be taken at or near G, the point on P closest to the centroid of the data points. Point  $(x_1, y_1, z_1)$  should be determined such that its distance from P is comparable with the span of the data points. Any point  $(x, y, z)$  on P satisfies the equation:

$$(x_1 - x_0)(x - x_0) + (y_1 - y_0)(y - y_0) + (z_1 - z_0)(z - z_0) = 0 \quad (5-2)$$



A circle in three dimensions should be specified by its centre and radius, and the plane in which it lies. Since the centre of the circle lies in the plane, this point should be used in specifying the plane.

A circle C should be specified by:

- 1) its centre  $(x_0, y_0, z_0)$ ; and
- 2) its radius  $r$ ; and either
  - (i) the direction cosines  $(a, b, c)$  of the normal to the plane containing C; or
  - (ii) a point  $(x_1, y_1, z_1)$  on the normal at the centre of C to the plane containing C.

Point  $(x_1, y_1, z_1)$  should be chosen such that its distance from the centre is comparable to the radius.

A cylinder C, related to a set of data points, should be specified by:

- 1) the axis of C, and
- 2) its radius  $r$ .

If the axis is specified by a point  $(x_0, y_0, z_0)$  on a line L; and its direction cosines  $(a, b, c)$ , the point  $(x_0, y_0, z_0)$  should be taken close to the midpoint of the part of the axis that is enclosed by the data. Any point  $(x, y, z)$  on L satisfies the equation:

$$(x, y, z) = (x_0, y_0, z_0) + t(a, b, c) \quad (5-3)$$

for some value of  $t$ , where  $t$  is a parameter proportional to distance.

#### **5.5.1.2. Data Fitting Criteria**

The computed reference should give the position and size of the geometric element and can be used in the assessment of the workpiece. For example, the reference for circularity should normally be the centre coordinates and the radius of a computed circle. For instance, this circle may be the smallest circle enclosing the data points.

The reference is defined by the parameters of the corresponding geometric element that best fits the measured points. The fit is represented by the values of its parameters, e.g. radius and centre coordinates of a circle. Many different criteria for specifying the best fit are possible. In general, the criterion should be to make some combination of the residuals as small as possible. In mathematical terms, the reference is obtained by optimizing the chosen combination of the residuals with respect to the parameters. Examples of criteria for specifying best fit are:

- least squares:  $\min \sum_i res_i^2$ ; and
- minimax:  $\min(\max_i |res_i|)$

Here, the residual,  $res_i$  is a measure of the departure of the  $i^{th}$  point from the fit. The residual is conventionally defined as the distance of the point from the reference. However, when calculating a reference circle by least squares, a particularly simple algorithm can be obtained if the residual is taken to be the difference between the squared distance of the point from the circle centre and the squared radius of the circle. Not all criteria are of this general form. Frequently used criteria are least squares, minimax, maximum inscribed and minimum circumscribed.

The purpose of data fitting is to apply an appropriate algorithm to fit a perfect geometric form (e.g. line, plane, circle, ellipse, cylinder, sphere, cone) to sampled data points obtained from the inspection of a manufactured part. The perfect form approximation obtained through fitting is called a substitute feature. The substitute feature is represented by a shape vector  $\mathbf{b}$ . The exact nature of  $\mathbf{b}$  varies with the geometric form being fitted. The substitute feature is a one-dimensional curve or a two-dimensional surface that we designate as a function  $\mathbf{f}(\mathbf{u};\mathbf{b})$  of a parameter vector  $\mathbf{u}$ . The values of  $\mathbf{f}$  are points in space (or on a surface, if fitting is being done in two dimensions). As  $\mathbf{u}$  varies,  $\mathbf{f}$  moves along the geometry represented by  $\mathbf{b}$ ; as  $\mathbf{b}$  varies, the surface changes shape and location. A particular geometry need not have a single representation. In fact, much of the research on fitting techniques is based on developing clever representations for curves and surfaces.

The fitting problem, generally stated, is to minimize some objective function with respect to  $\mathbf{b}$ . For some kinds of fitting (to be described below) the minimization may be subject to certain constraints. The most frequently used fitting algorithms are based on the  $L_p$  norm:

$$L_p \doteq \left[ \frac{1}{N} \sum_{i=1}^N |e_i|^p \right]^{1/p} \quad (5-4)$$

where  $0 < p < \infty$ ,  $N$  is the total number of data points, and  $e_i$  is the shortest distance between  $p_i$ , the  $i^{\text{th}}$  data point, and the considered feature. The best fit feature is the feature that minimizes the  $L_p$  norm. Since  $N$  is a constant,  $1/N$  is usually omitted from the equation in most surface fitting applications. Similarly, since  $p$  is fixed, the exponent  $1/p$  is often omitted. The resulting objective function is

$$S_p \doteq \sum_{i=1}^N |e_i|^p \quad (5-5)$$

$S_p$  represents the same problem as the  $L_p$  norm. The value of  $\mathbf{b}$  that minimizes  $L_p$  (and  $S_p$ ) is called the  $L_p$  estimator of the feature. When  $p=1$ , the fitting problem is least-sum-of-distances fitting, a generalization of finding the median of a data set. When  $p=2$ , it is total-least-squares fitting, also called orthogonal distance regression.  $L_p$  fitting can be extended to  $p = \infty$  by noting that  $\lim_{p \rightarrow \infty} L_p = \max_i |e_i|$ . Minimizing  $L_\infty$  is called the two-sided minimax problem, because the solution minimizes the maximum  $e_i$  on both sides of the feature. One-side minimax fitting is a constrained two-sided minimax fitting. The objective functions for smallest circumscribed features and the largest inscribed features are somewhat different than one-sided minimax objective functions, but the fitting results often appear similar.

A number of research studies have been conducted investigating data fitting algorithms. Feng and Hopp [145] from NIST have made a thorough review of inspection data fitting algorithms. It is found that among the six data fitting algorithms (least-sum-of-distances fitting, total-least-squares fitting, two-sided minimax fitting, one-sided minimax fitting,

smallest circumscribed fitting, and largest inscribed fitting) both least-sum-of-distance fitting and total-least-square fitting are suitable for fitting data to all geometry elements. However, the latter one is more sensitive to data outliers and embedded errors. The rest of the four types fitting algorithms are especially suitable for fitting data into cylindrical geometry. Two-sided minimax and one-sided minimax fitting are useful for estimating roundness, cylindricity, and some form deviations, but these two algorithms are strongly affected by data outliers. Smallest circumscribed fitting and largest inscribed fitting are more suitable for geometry elements of size such as circles, cylinders, and spheres. As with two-sided minimax and one-sided minimax fitting algorithms, these two algorithms are very sensitive to data outliers. Considering that OMM is carried out on a machine tool, the errors embedded in hardware such as hysteresis, kinematic error, etc. are larger than those on a CMM. Therefore, it is more sensible to choose least-sum-of distance fitting for the proposed system. Algorithms of fitting a perfect geometric element to a set of measured data points [146] are employed and integrated in the developed software prototype system.

### 5.5.2. Tolerance Zone Analysis and Feedback Update

Once the data fitting process is finished, the generated geometry is compared with the tolerance zone requirements and machining allowance information from the input data file. Tolerance zone can be categorized into two types.

- A cylindrical area in which the axis of a cylindrical surface must lie in.
- An area between two parallel planes/axes.

Table 6 summarizes the geometric tolerances and their possible tolerance zone shapes. This research tested seven geometric tolerances in the implemented software prototype system. In the proposed STEP Application Protocol ARM data model for integrated CNC machining and inspection, two types of tolerance zone are defined (refer to Section 4.2.3). Therefore, the measurement result analysis and feedback system can trace tolerance zone and machining allowance information from the input STEP Part 21 file.

Table 6: Geometric tolerances and their tolerance zone

| Geometric tolerance      | Cylindrical tolerance zone | Tolerance zone between two parallel planes/axes | Tested in this research |
|--------------------------|----------------------------|---|-------------------------|
| Angularity               | ✓                          | ✓   | ✓                       |
| Coaxiality/Concentricity | ✓                          | ✗   | ✗                       |
| Cylindricity             | ✓                          | ✗   | ✓                       |
| Flatness                 | ✗                          | ✓   | ✓                       |
| Parallelism              | ✓                          | ✓   | ✓                       |
| Perpendicularity         | ✓                          | ✓   | ✓                       |
| Position                 | ✓                          | ✓   | ✓                       |
| Roundness/Circularity    | ✓                          | ✗   | ✗                       |
| Straightness             | ✓                          | ✓   | ✗                       |
| Symmetry                 | ✓                          | ✓   | ✓                       |
| Total runout             | _____                      | _____   | ✗                       |
| Circular runout          | _____                      | _____   | ✗                       |
| Surface profile          | _____                      | _____   | ✗                       |
| Line profile             | _____                      | _____   | ✗                       |

The generated geometry is first compared with machining allowance requirements. In the Part 21 file, each machining\_operation has its allowance information. For example, if the machining\_operation is a bottom\_and\_side\_milling, then there are both side\_allowance and bottom\_allowance requirements in the data file. Each machining allowance has its allowable variations [136], which means that if the generated geometry is within this allowance, the next machining operation (finishing operation) can be carried out to guarantee the tolerance requirement. On the contrary, if the generated geometry is under the allowance variations (workpiece is undercut for example), the allowance of the next machining operation has to be updated with the new value, or if necessary, a new semi-finishing machining operation can be inserted before the finishing operation. If the

generated geometry is over the allowance variation (workpiece is overcut for example), the whole machining process has to be stopped as the allowance requirement is violated.

If the machining allowance is satisfied, the subsequent finishing operation is carried out. Tolerance zone information is traced when in-process measurement is chosen to do a final inspection of the machined feature after finishing operations. A comparison is performed to check if the final geometry is within the tolerance zone. If the tolerance zone requirement is satisfied, machining proceeds.

## 5.6. Recap

This chapter presents a detailed description of the proposed integrated process planning system. It consists of four main sub-systems: the measurement geometry selection/creation system, the workingstep re-sequence system, the micro inspection process planning system, and the measurement result analysis and feedback system. The measurement geometry selection/creation system first processes the input STEP data file through a tolerance filter, where critical tolerances are identified and related machining features and toleranced geometry information are traced. Then, the developed measurement geometry rules make decisions on selecting appropriate measurement geometry for each critical tolerance. After selecting proper measuring devices, the workingstep for each measurement geometry is then inserted into machining workingsteps through the workingstep re-sequence system.

Each `dm_workingstep` is then processed through the micro inspection process planning system, which is made up of four sub-systems. Measurement points and their distributions are first determined, then feature interaction is detected to check whether the measurement geometry interacts with other features/geometry. If interaction exists, measurement points reallocation algorithm is called to reallocate those measurement points that are located on the virtual surfaces. The measurement points are then finally re-sequenced through a TSP algorithm to generate the shortest probing sequence for measurement execution.

After each measurement operation is executed, the measurement results are fed into the data fitting system, which is part of the measurement result analysis and feedback system.

The “true” geometry is then generated and compared with machining allowance and tolerance zone requirements. Necessary modifications to the subsequent machining operations are then made. If any requirements are violated, the whole machining process is terminated.

# *Chapter 6 System Implementation and Case Studies*

Chapter 5 introduced the proposed integrated process planning system, its methodologies, and the developed algorithms. This chapter describes the implementation of this integrated process planning system. A software prototype called STEP-INSPEC has been developed in this research. The software is developed under the Microsoft Visual Studio 2005 environment with the utilization of multiple software tools, such as ST-Developer™, Open CASCADE®, Microsoft Foundation Class® (MFC®), and GUN Scientific Library (GSL). This chapter first introduces the software development environment and the software tools. Then, the software information flow is described in detail.

Two case studies have been carried out to test the proposed STEP data model and the integrated process planning system. The software functionalities are introduced together with the case studies. The major part of this chapter has been presented in two international conferences [6, 7] and is reported in one journal paper *in-press* [4].

## **6.1. Software Development Environment and Tools**

The STEP-INSPEC software prototype is developed under the Microsoft Visual Studio environment in C++ programming language. ST-Developer™ software package is used to convert EXPRESS schema into C++ classes and libraries. Open CASCADE® software package is used to generate 3D visualization of workpiece and measurement points information in the STEP-INSPEC software interface. Functions from GNU Scientific Library (GSL) are used to handle mathematical and matrix calculations.



### 6.1.1. Microsoft Visual Studio and Microsoft Foundation Class®

Microsoft Visual Studio is an Integrated Development Environment (IDE) from Microsoft®. It can be used to develop console and graphical user interface applications along with Windows Forms applications, Web sites, Web applications, and Web services in both native code together with managed code for all platforms supported by Microsoft Windows, Windows Mobile, Windows CE, .NET Framework, .NET Compact Framework and Microsoft Silverlight [147]. Visual Studio supports languages by means of language services, which allow any programming language to be supported (to varying degrees) by the code editor and debugger, provided a language-specific service has been authored. Built-in languages include C/C++ (via Visual C++), VB.NET (via Visual Basic .NET), and C# (via Visual C#). C++ is the programming language utilized in this research to develop the software prototype.

Microsoft Foundation Class® Library is a collection of pre-defined C++ classes (generalized definitions used in object-oriented programming) that simplifies basic operations in a Windows-based application. The MFC® Library saves programmers' time by providing a pre-written code. It also provides an overall framework for developing the application program such as managing windows, menus and dialog boxes; performing basic input/output; and storing collection of data objects. Because of the derive and override features of the C++ language, it is possible to construct new powerful classes based on MFC® which can extend the basic functions provided by MFC® to realise developers' intents. Furthermore, MFC® also provides support for more complex operations such as database connections and network programming. Hence, development time can be greatly shortened by using MFC® in developing Windows-based C++ programs.

### 6.1.2. ST-Developer™

ST-Developer™ from STEP Tools Inc [86] is a set of programming libraries and tools to manage data using the STEP standard. It provides a software tool for working with EXPRESS information models and EXPRESS-defined data sets in a variety of database

and programming environments. It offers libraries with reading, writing, and processing STEP data Part 21 formats. It also provides EXPRESS compiler, which can check the EXPRESS information models and produces C++ code for building applications. The architecture of ST-Developer™ is shown in Figure 69.

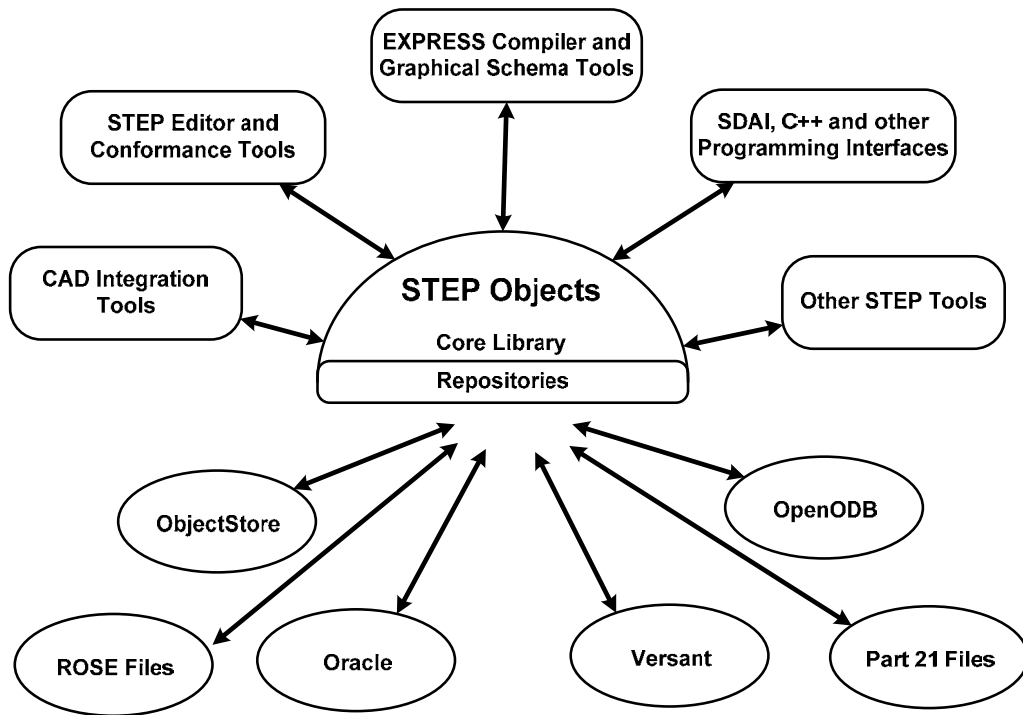

Figure 69: ST-Developer™ architecture

These EXPRESS tools provided by ST-Developer™ process STEP schema definitions and produce C++ classes, SDAI data-dictionaries, and HTML. The EXPRESS-G tools construct EXPRESS-G diagrams from any EXPRESS information model and display, rearrange, and print them using a graphical editor.

The EXPRESS compiler produces C++ definitions from EXPRESS information models, and then uses these classes with the ROSE library to build application software and object orientated databases. The ROSE C++ library includes predefined functions in the C++ language that are used to create and manipulate EXPRESS-defined data.

ROSE® stands for a STEP Index library for ISO 10303. It is an additional C++ library for ST-Developer™ that provides “cursors” and “functions” to manage STEP physical files.

ROSE C++ classes provide methods for managing STEP objects. The ROSE class library provides methods that can be used to create, read, write, and manipulate STEP objects. STEP objects are C++ objects that have the following additional characteristics.

- Their data structure is defined by an EXPRESS information model.
- They can be written out in the STEP Physical File format (Part 21 file).

The EXPRESS schema of the proposed STEP Application Protocol ARM data model for integrated CNC machining and inspection can be compiled into C++ classes and according ROSE C++ library (Figure 70). This can be done by using the EXPRESS compiler in ST-Developer™, which is processed through the Express2C++ tool in the ST-Developer™ package.

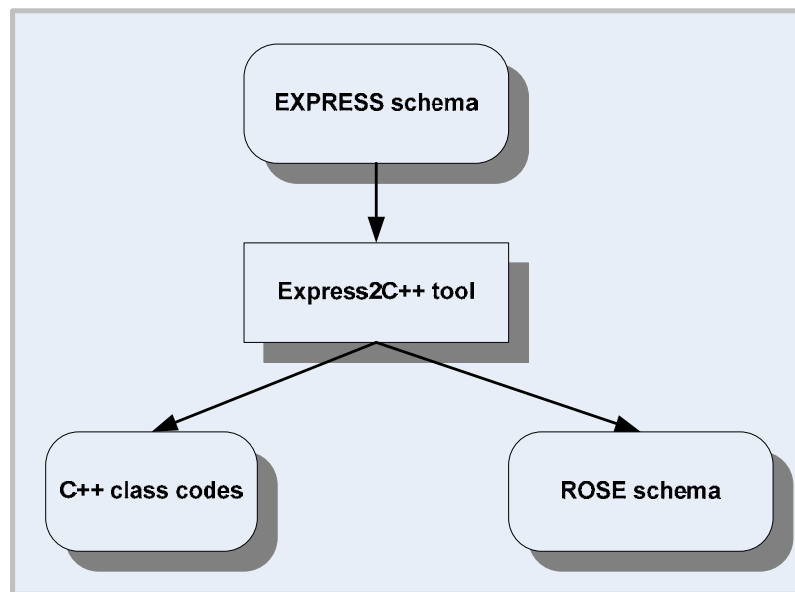

**Figure 70: Compiling EXPRESS source for use in application program**

The compiler takes the EXPRESS schema as the input, and compiles each entity within the EXPRESS schema into C++ source code. The C++ source code is effectively a set of C++ class definitions for each entity, consisting of .cxx and .h files. This way, the data structure defined by the EXPRESS schema is unambiguously mirrored by the C++ classes. To assist maintaining the relationship between the EXPRESS definitions and the generated C++ classes, a ROSE schema file is used. This file contains data dictionary descriptions of the EXPRESS entities, enabling the application to manage STEP objects in the C++ program.

The compilation process in ST-Developer™ also generates some utility functions (in form of C++ classes) that are useful for manipulating data models in an application. These utility functions are converted to subclasses of the ROSE C++ base classes in the system. The ROSE C++ classes provide methods to manage basic STEP objects. Figure 71 shows input (e.g. part10.exp and part 11.exp), output (e.g. machining\_feature.cxx, machining\_feature.h, etc.), and ROSE schema files (e.g. machining\_schema and milling\_schema) from the EXPRESS compiler.

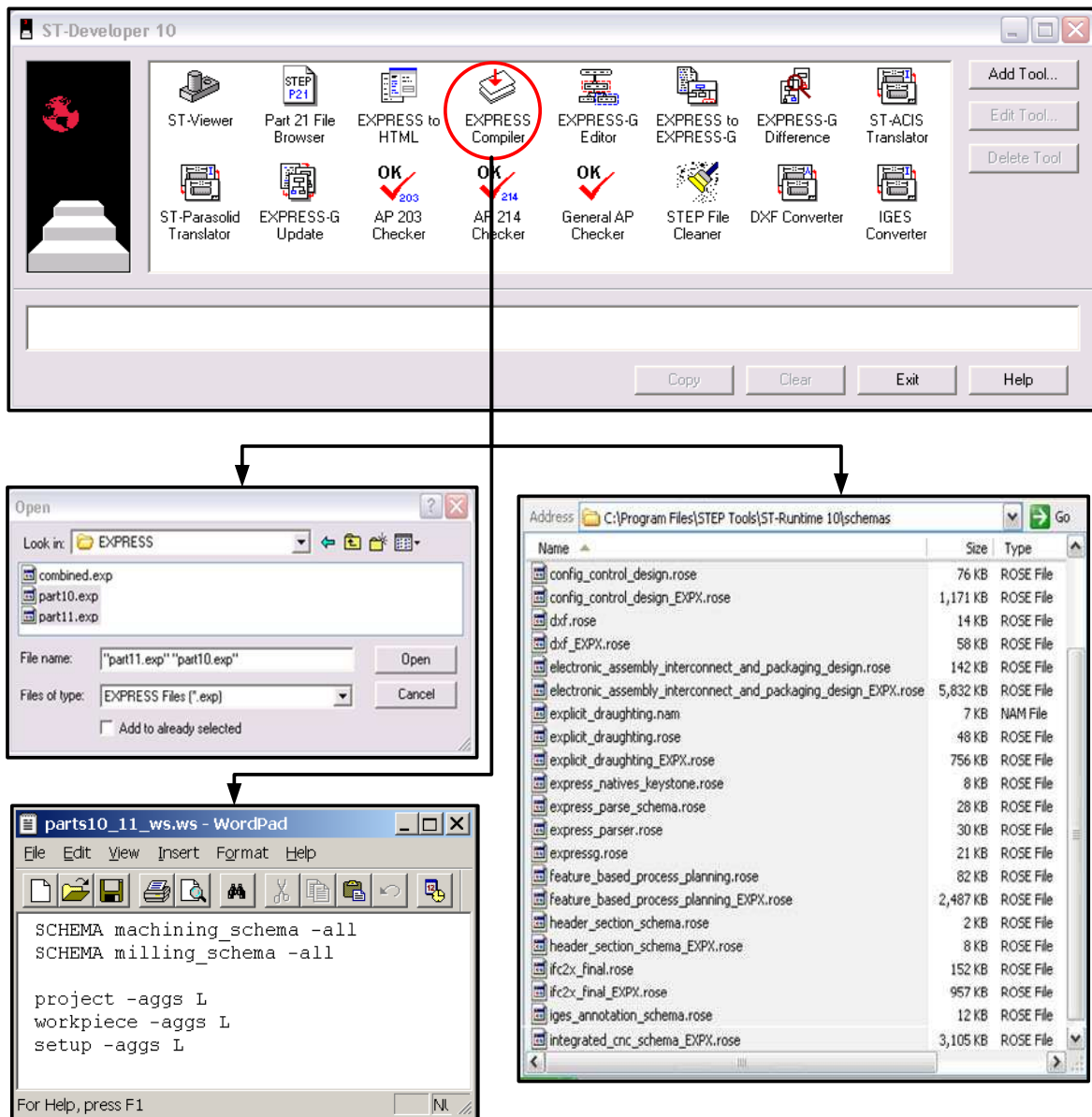

Figure 71: Converting STEP EXPRESS schema into C++ classes and ROSE schema files

### 6.1.3. Open CASCADE®

Open CASCADE® [148] is a software development platform available as an open source. It includes components for 3D surface and solid modelling, visualization, data exchange and rapid application development.

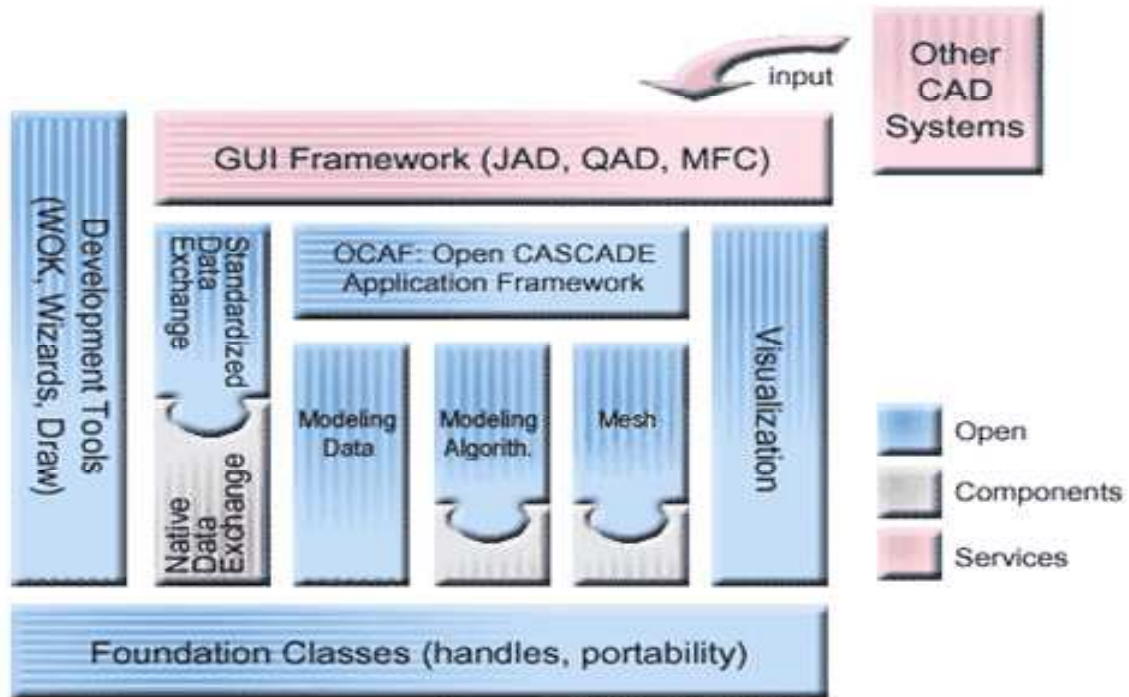

Figure 72: Open CASCADE® software platform structure

In this research, functions from Modelling Data are used to produce 3D visualization. Modelling Data supplies data structures to represent 2D and 3D geometric and topological models. These structures are organized in the following libraries.

#### 1) 2D Geometry

This library provides 2D geometric data structures and topological orientation. The geometric package Geom2D provides STEP-compliant 2D geometric data structures handled by reference. These objects are parameterized, and are as a result, oriented. They include Bezier, BSpline, and offset curves, and provide

functions for conversion of Geom2D objects to gp (basic geometry) objects, which are non-oriented and non-parameterized.

## 2) 3D Geometry

This library provides 3D geometric data structures and topological orientation. The geometric package Geom3D provides STEP-compliant 3D geometric data structures handled by reference. These objects are also parameterized and oriented. They include Bezier, BSpline, offset curves, and surfaces, and provide functions for conversion of Geom3D objects to gp (basic geometry) objects, which are non-oriented and non-parameterized. The geometric properties package GeomLProp allows users to compute such properties as:

- Derivative vectors of a parametric point on a curve or surface
- Tangent vectors of a parametric point on a curve or surface
- Normal
- Curvature

## 3) Topology

The topological library allows programmers to build pure topological data structures. Topology defines relationships between simple geometric entities. In this way, complex shapes can be modelled as assemblies of simpler entities. The built-in non-manifold (or mixed-dimensional) feature allows programmers to build models mixing:

- 0D entities such as points
- 1D entities such as curves
- 2D entities such as surfaces
- 3D entities such as volumes.

### 6.1.4. GNU Scientific Library

The GNU Scientific Library [149] is a collection of routines for numerical computing. The routines are written from C, and present a modern API for C programmers, allowing wrappers to be written for high level languages such as C or C++ programming. The source code is distributed under the GNU General Public License. The library covers a wide range of topics in numerical computing. Routines are available for the following areas:

|                         |                         |                       |
|-------------------------|-------------------------|-----------------------|
| Complex Numbers         | Random Distributions    | Chebyshev             |
| Roots of Polynomials    | Quasi-Random            | Approximations        |
| Special Functions       | Sequences               | Root-Finding          |
| Vectors and Matrices    | Histograms              | Discrete Hankel       |
| Permutations            | Statistics              | Transforms            |
| Combinations            | Monte Carlo Integration | Least-Squares Fitting |
| Sorting                 | N-Tuples                | Minimization          |
| BLAS Support            | Differential Equations  | IEEE Floating-Point   |
| Linear Algebra          | Simulated Annealing     | Physical Constants    |
| CBLAS Library           | Numerical               | Basis Splines         |
| Fast Fourier Transforms | Differentiation         | Wavelets              |
| Eigensystems            | Interpolation           |                       |
| Random Numbers          | Series Acceleration     |                       |
| Quadrature              |                         |                       |

The routines for Linear Algebra and Least-Square Fitting are used in the implementation of STEP-INSPEC software prototype.

### 6.2. STEP-INSPEC Software Prototype

The STEP-INSPEC implementation environment has to include compiled C++ libraries and source codes from the aforementioned software development tools and package. After the programming environment is set up, the implementation process starts. This section

first introduces the implementation environment setup. Then, a detailed STEP-INSPEC system information flow is presented and discussed.

### 6.2.1. Implementation Environmental Setting

The STEP-INSPEC software requires links to additional source codes and compiled C++ libraries (Figure 73). The additional directories include:

- Open CASCADE® ros\inc folder, which contains all Open CASCADE® header files;
- ST-Developer™ ROSE\_include folder, which contains basic ST-Developer™ headers;
- Compiled C++ source codes generated by ST-Developer™ from STEP data model EXPRESS schema;
- GSL windows including folder – GSL\_windows\include, which contains all GSL library headers; and
- TSP application source codes, which contain header files for the travelling sales person algorithm.

The additional library directories include:

- Open CASCADE® ros\win32\lib folder, which contains all compiled libraries for Open CASCADE® windows applications;
- ST-Developer™ ROSE\_lib folder, which contains all pre-compiled ROSE libraries;
- Compiled C++ library from the STEP schema;
- GSL windows library folder – GLS\_windows\lib; and
- TSP C++ library.

After linking up these source codes and library directories, the Microsoft visual studio system is able to automatically load the related .lib files for the programming environment (indicated by the red circle in Figure 73).



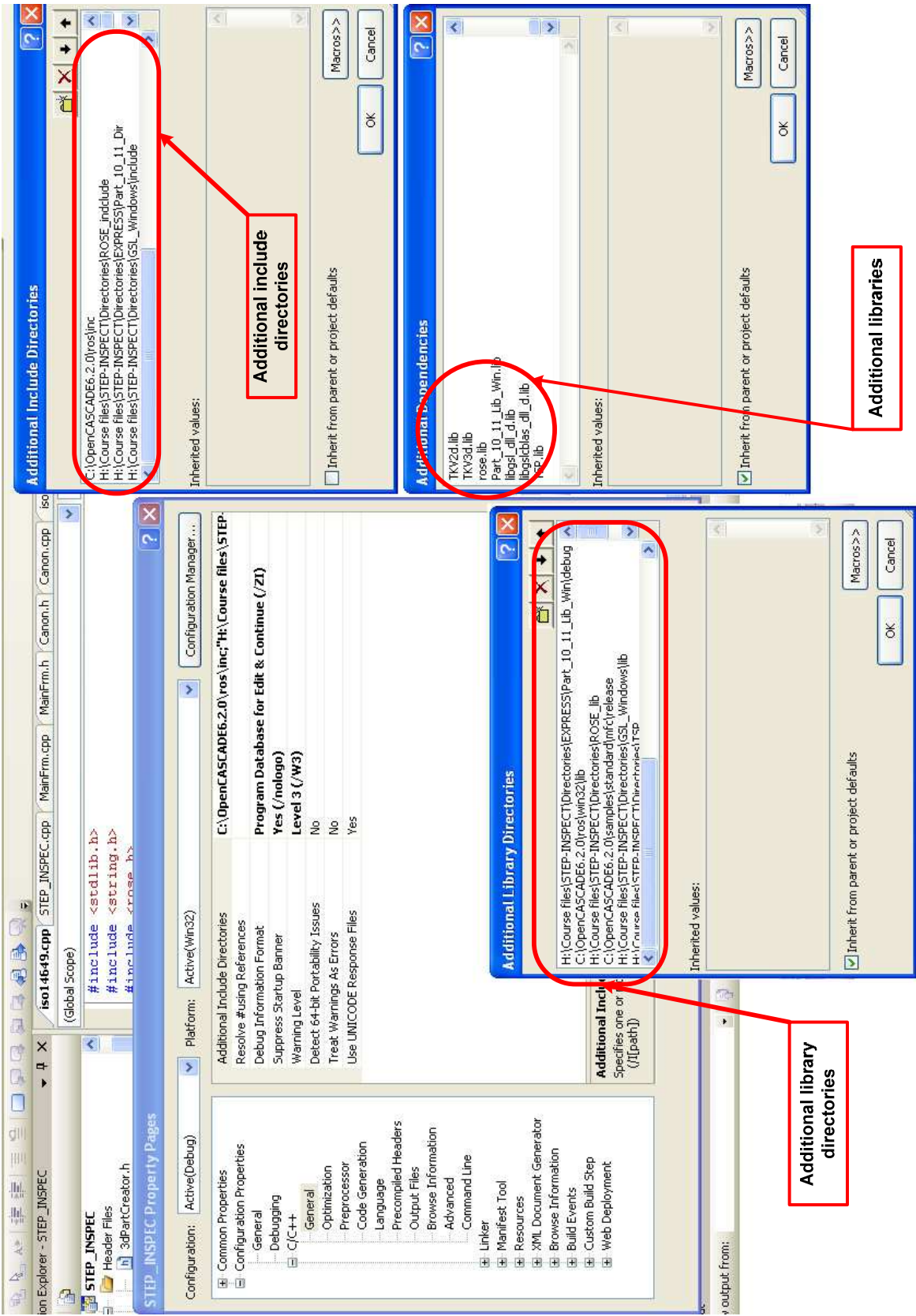

Figure 73: STEP-INSPEC software library and additional directory setup

### 6.2.2. STEP-INSPEC Software

Chapter 4 presented the proposed STEP Application Protocol ARM data model for integrated CNC machining and inspection and Chapter 5 introduced the integrated process planning system for machining and in-process measurement. An implementation software of the proposed system – STEP-INSPEC was developed. The input interface of STEP-INSPEC is shown in Figure 74.

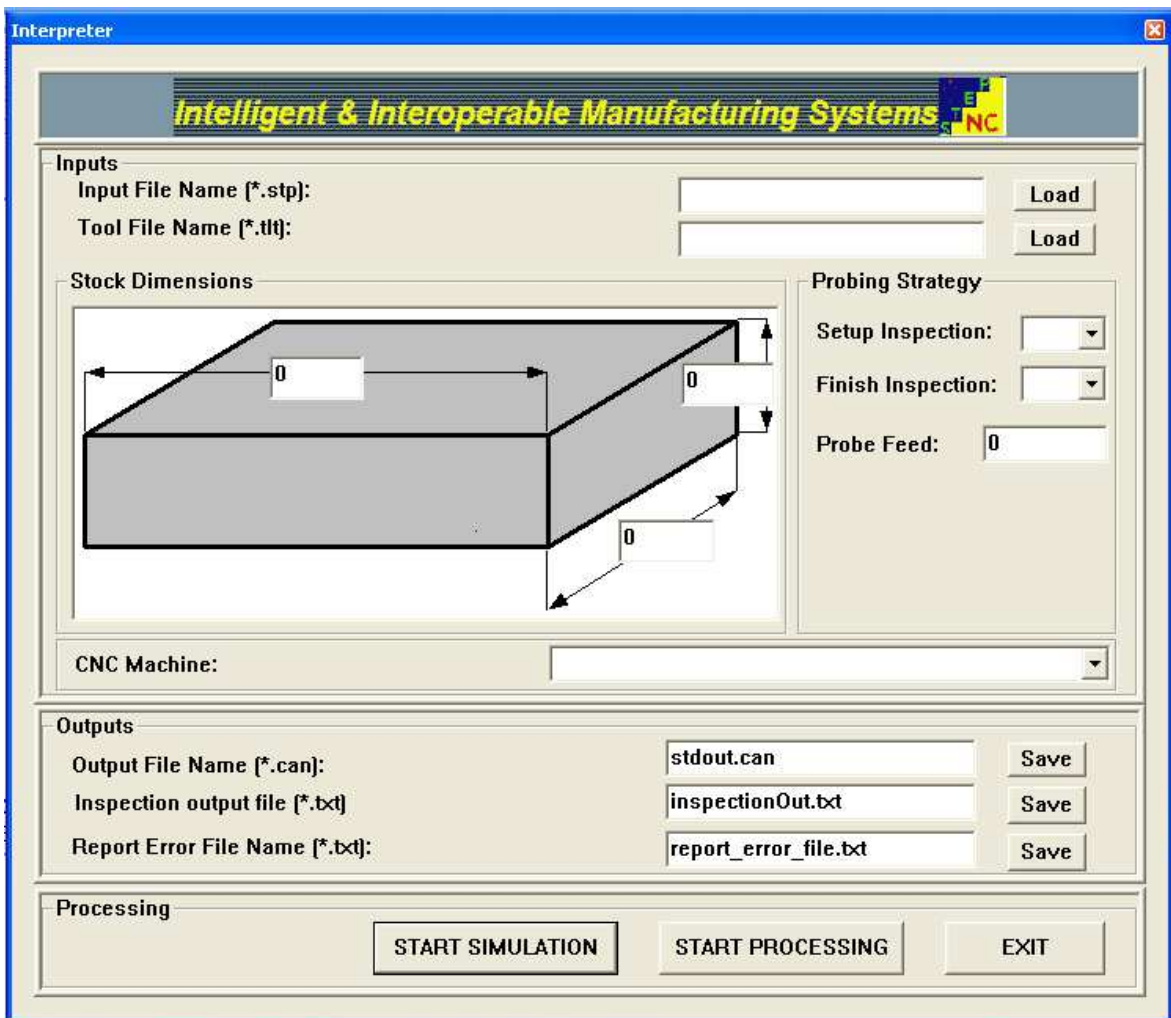

Figure 74: STEP-INSPEC input interface

The interface comprises six parts: Inputs, Stock Dimensions, Probing Strategy, CNC machine, Outputs, and Processing. In the Inputs part, the user can select the input STEP Part 21 file (\*.stp) and tool file (\*.tlf). The tool file includes all the machining cutters and probing devices. The Stock Dimension allows users to input the size of the stock

workpiece. The current ISO 14649 Part 10 does not include stock information, therefore, the interface allows the user to input the stock dimensions. The Probing Strategy part allows the user to choose whether or not to have setup inspection and finish inspection for the process planning job. It also allows the user to decide the probing speed; this probing speed will be saved into the newly generated STEP Part 21 files (which has the new measurement operations). The CNC machine selection window links with the CNC machine accuracy database (refer to Section 5.2.1). The user is able to select a machine tool to be used for the current process planning job. The machine accuracy information of the selected CNC machine tool is then passed to the system for decision making. The STEP-INSPEC software has multiple outputs. The Process part in the interface allows the user to select the process mode: simulation, processing, or exit. Figure 75 shows the STEP-INSPEC system output interface. The detailed output windows are shown in Figure 76.

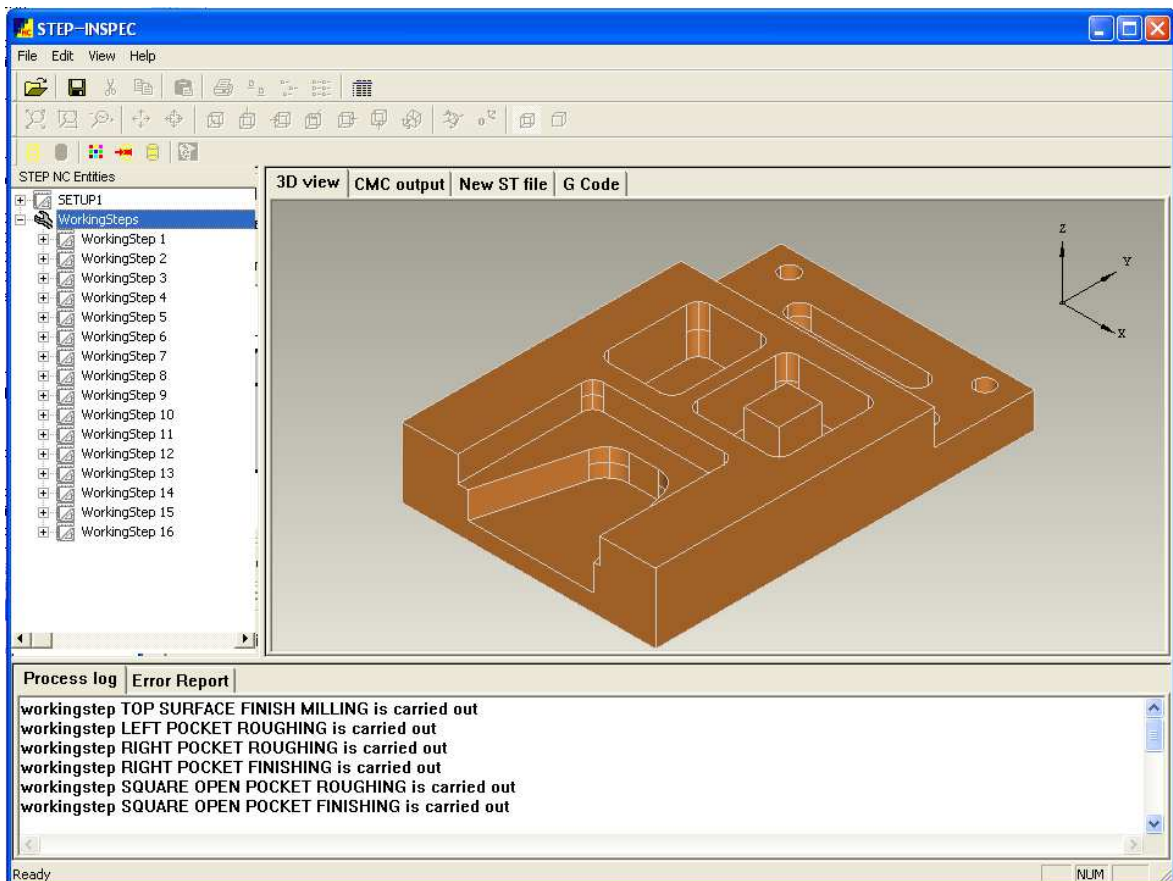

Figure 75: STEP-INSPEC software input and output interface

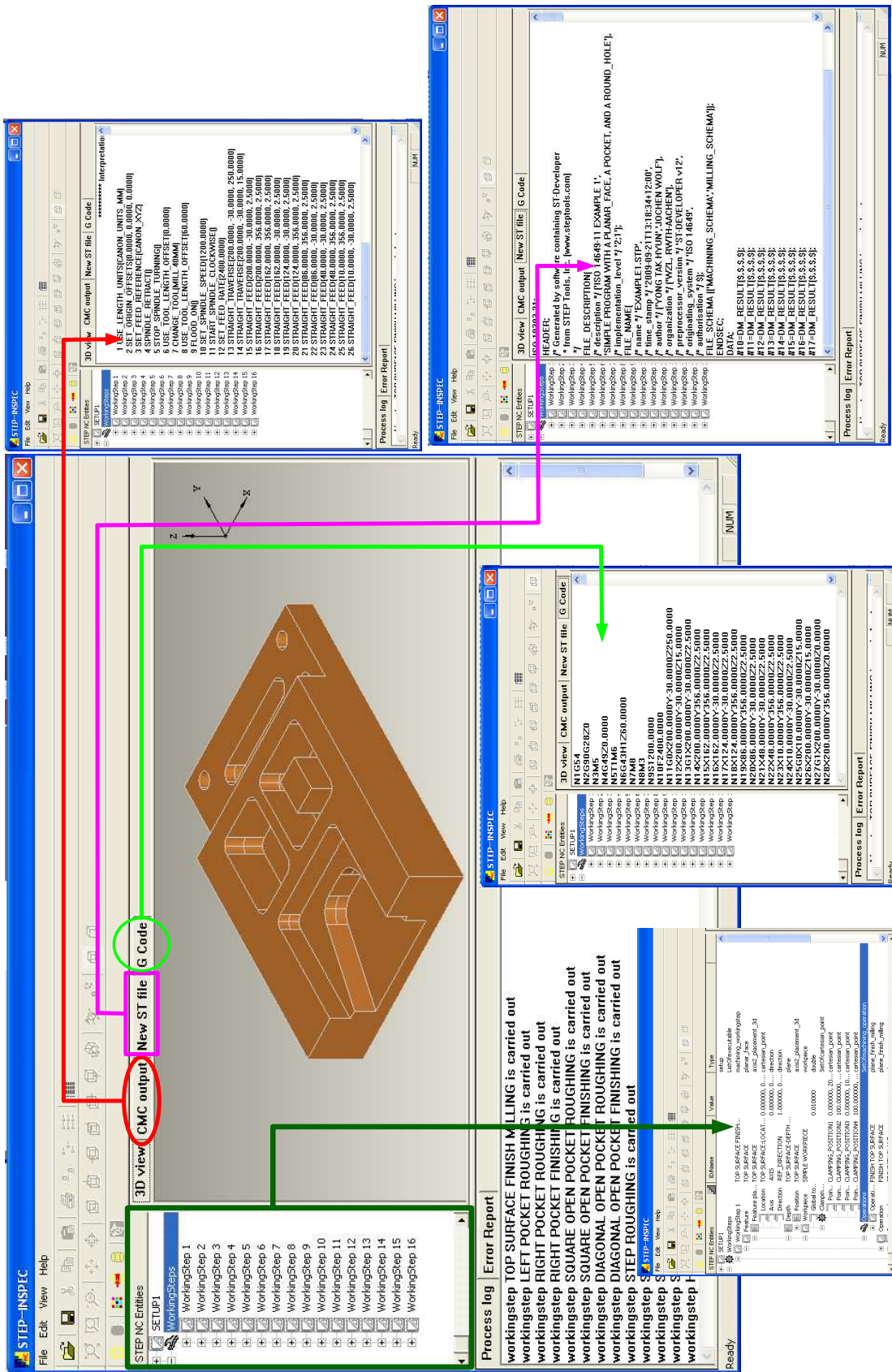

Figure 76: STEP-INSPEC system outputs and tree-view

The interface window has three sections. The top left-hand side window section is the tree-view window. This window displays input information from the STEP Part 21 file in a tree-view fashion. Tree-view information includes input entities, their entity ID/names, Values, and entity types. The top right-hand side window section has four tabs. The first tab displays the 3D workpiece with measurement points (represented as yellow crosses as shown in Figure 81). The section tab shows the Canonical Machining Commands (CMC command) [150] output, the third tab displays the newly generated Part 21 file that has inspection workingstep, operation, feature, and result information generated by the integrated process planning. The fourth tab is for G code output. This software generates G-code for a Mitsubishi 3-axis CNC machine to test the output of the STEP-INSPEC. The bottom window section has two tab views. One is for displaying the process log. Since the whole process is carried out behind the screen, it is more informative to show the operators to display up to which stage the interpretation has processed. This is realized by the log display. The second tab view is for error reporting.

### 6.2.3. STEP-INSPEC Software Information Flow

The entire STEP-INSPEC software consists of four parts: tree-view generator, 3D view generator, process planner, and interpreter (Figure 77). The tree-view generator extracts machining features and machining operation information, then displays them in a tree-list together with generated inspection features and inspection operation information. The 3D viewgenerator displays the workpiece, its features, and measurement points for inspection operations. The process planner carries out the aforementioned decision-making and process planning, generates machining and inspection commands and outputs a new STEP Part 21 file with new inspection workingsteps inserted in the workplan. The system can generate two types of machining commands: CMC and G code.

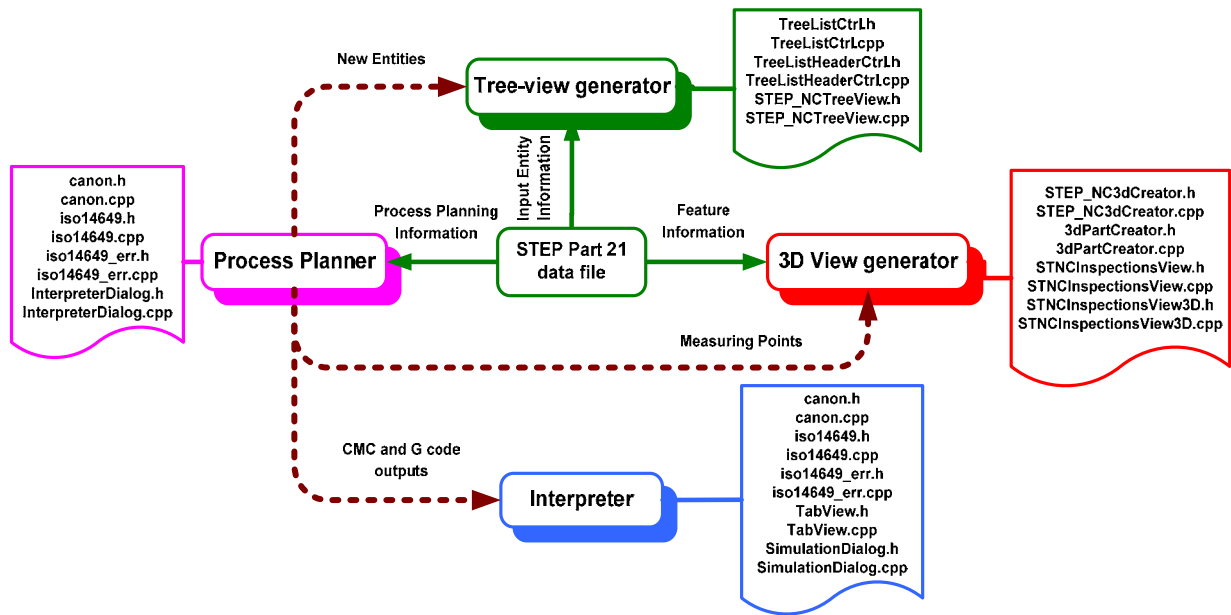

Figure 77: Four elements of STEP-INSPEC software system and their program files

After input files are loaded, the software proceeds with information extraction, displaying, process planning, and interpretation. Figure 78 is the information flowchart of the STEP-INSPEC software. The input Part 21 file has only machining\_workingsteps and tolerance requirements. Workplan alternation is therefore needed to incorporate inspection workingsteps. A workplan is a list of workingsteps. The sequence of these workingsteps is generated by a pre-machining process planning tool. After the operator chooses a machine tool to produce the workpiece, this sequence may need to be changed depending on the machine accuracy and its characteristics. For example, if a parallel machine tool is chosen to machine a workpiece with a tightly toleranced pocket and cylinder, since the machine tool is good at producing cylindrical features, it is recommended that the pocket is to be machined first. Because if the machine can not satisfy the tolerance requirement on the pocket based on in-process measurement, there is no point machining the cylinder. Hence, the workplan alternation may sometimes re-sequence the machining\_workingsteps. It is important to note that this workplan alternation process is not ready to handle complex workpieces with feature interactions. It is more sensible to associate the workplan alternation process with the machining process planning process.

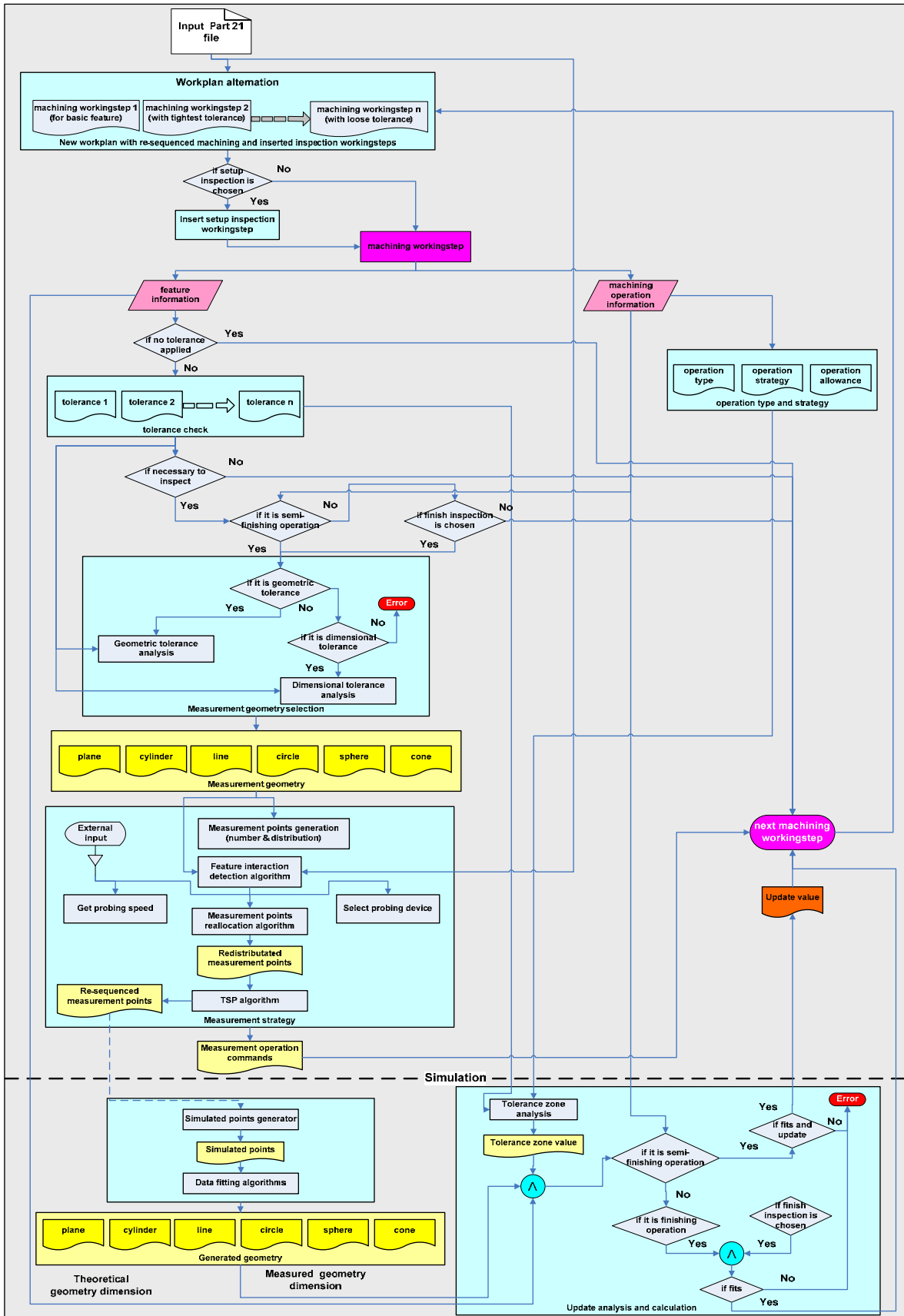

Figure 78: STEP-INSPEC software prototype system flowchart

The alternated workplan is then passed to the tolerance check function. As it is introduced in Section 5.3, four types of inspection operations were identified by the author in previous research [1]. Three types of inspection operations are implemented in this research. The software prototype allows the operator to decide whether or not to use this integrated process planning system to generate a setup inspection operation. After setup inspection selection, the tolerance checking function checks through all applied tolerances on the `machining_feature` of the current `machining_workingstep`; each `machining_workingstep` has a `machining_feature`. The tightest tolerance that is applied on each `machining_feature` is selected and compared with the machine accuracy information. If a tolerance is to be inspected after a semi-finish machining operation, an inspection operation is inserted after this machining operation. The `toleranced_geometry` of the feature (refer to Section 4.2.3 for `toleranced_geometry` definition) with critical tolerances is identified and the measurement geometry decision-making algorithm selects the geometry for measurement. The geometry size and location information is passed to the measurement strategy function to generate measurement points and their allocations. It should always be borne in mind that the inspection process should be kept to a minimum. Therefore, only the geometry element of the feature on which a critical tolerance is applied will be inspected, not the entire feature. After feature interaction is detected, a new set of measurement points is generated for each measurement geometry. Then, the measurement strategy function selects a proper measuring device and considers an external input of the probing speed to generate measuring commands.

A simulation mode has been developed to simulate measured points and to test measurement results analysis and feedback system. The software gives operators the choice to select either a simulation mode or just processing mode (refer to Figure 74).

### 6.3. Case Studies

Two case studies have been carried out to test the proposed STEP Application Protocol ARM data model and STEP-INSPEC software prototype. The first case study is based on the ISO 14649 Part 11 standard. The second case study is based from a test example carried out by the STEP Manufacturing team (ISO TC184 SC4 WG3 T24) [151] in 2008.



### 6.3.1. Case Study 1

The example from ISO 14649 Part 11 (Example 1) is shown in Figure 80. The original Part 21 file contains five machining workingsteps. They are:

- 1) Top surface milling,
- 2) Hole drilling,
- 3) Hole reaming,
- 4) Pocket roughing, and
- 5) Pocket bottom finishing.

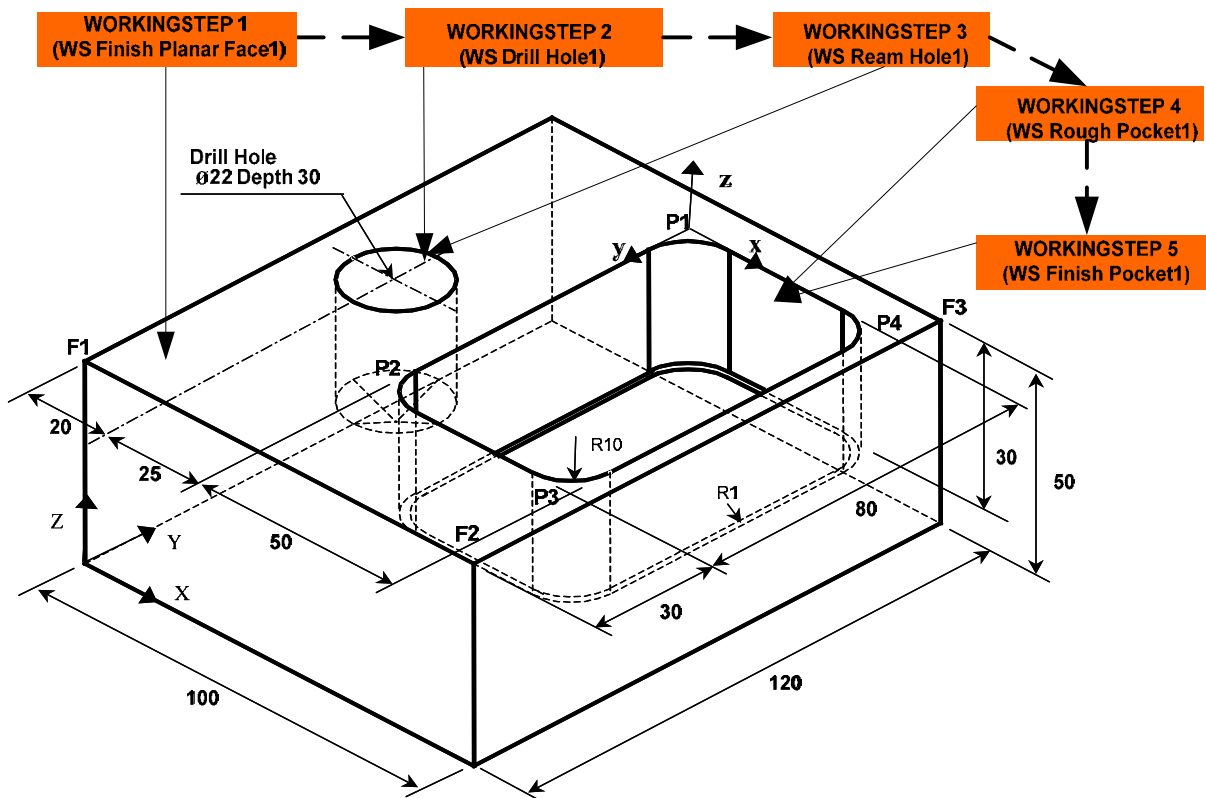
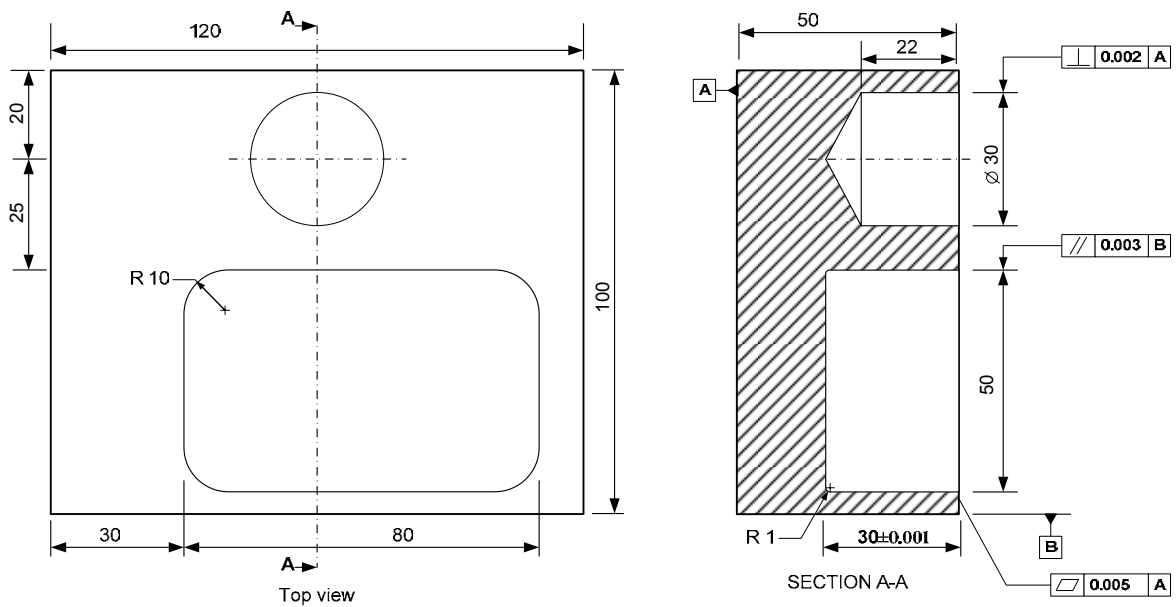

Figure 79: ISO 14649 Part 11 Example 1

For argument purposes, four tolerances have been added to the part (Figure 80): three are geometric tolerances (perpendicularity, parallelism, and flatness) and one is dimensional tolerance.



**Figure 80: Dimensions and tolerances of the example**

Figure 81 shows the STEP-INSPEC output of this case study with setup inspection chosen for the process planning but not the finish inspection. If a legacy 3-axis CNC machine tool (for example the MAZAK NEXUS 410A in the machine tool database) is chosen to machine the workpiece, in-process measurement is necessary to check each applied tolerance (measurement points and inserted inspection workingsteps are shown in Figure 81). However, if a state-of-the-art CNC machine tool (for example MAZAK VARIAXIS 630-5X II as in the database) is chosen, only the dimensional tolerance in the case study needs to be monitored, hence one inspection operation is inserted in-between the pocket semi-finishing and finishing operation.

Assume the MAZAK NEXUS 410A milling machine is used, then four inspection workingsteps as shown in Figure 81 are considered necessary for insuring the tolerance requirements. Figure 82 shows the sequence of the process plan after inspection workingsteps are inserted in-between the machining workingsteps.

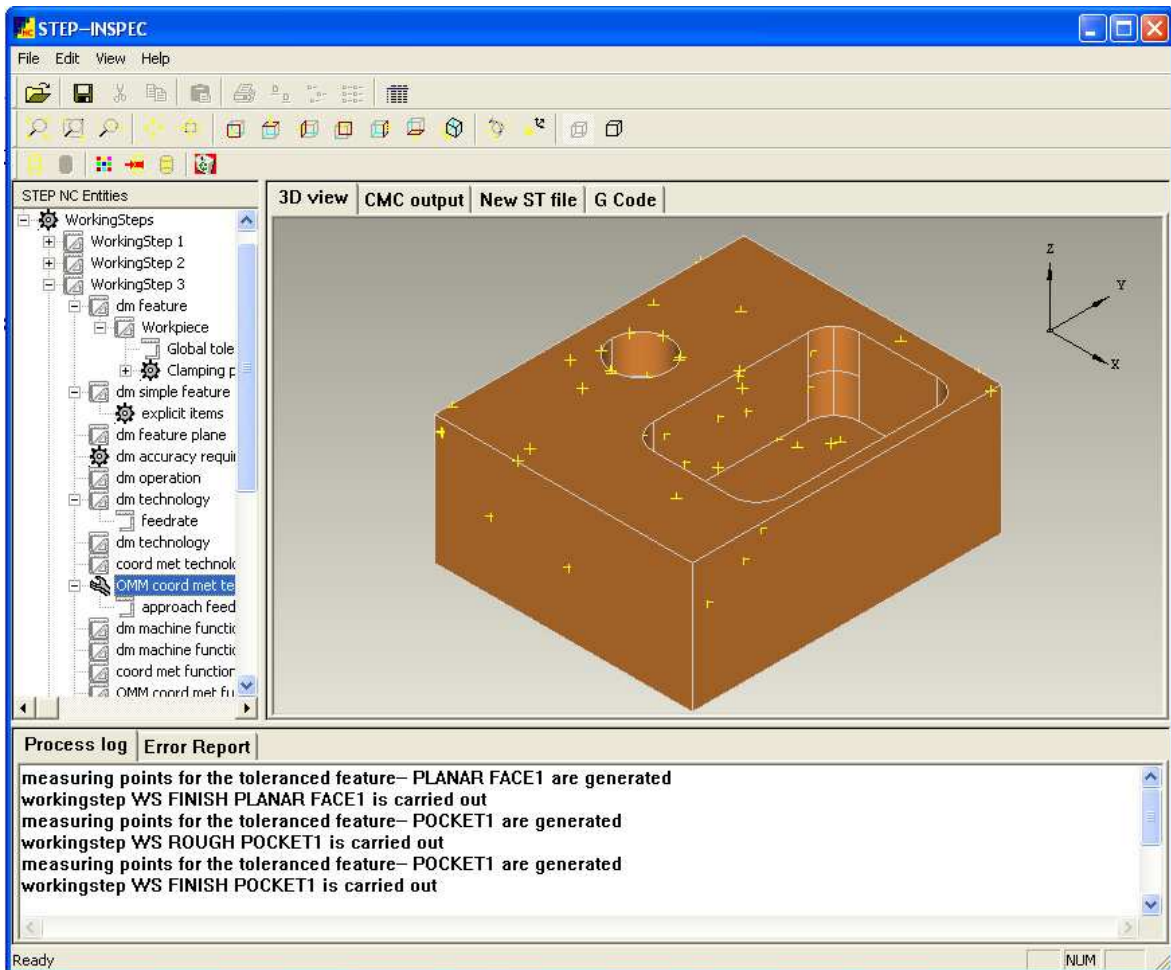

**Figure 81: Case study software output**

Any inspection operations carried out using OMM or on a CMM, can be categorized into the four inspection types summarized in Section 5.5. Most CMM inspections belong to the INSPECTION TYPE III. In this case study, three types of inspection are tested, i.e. INSPECTION TYPES I, II, and III.

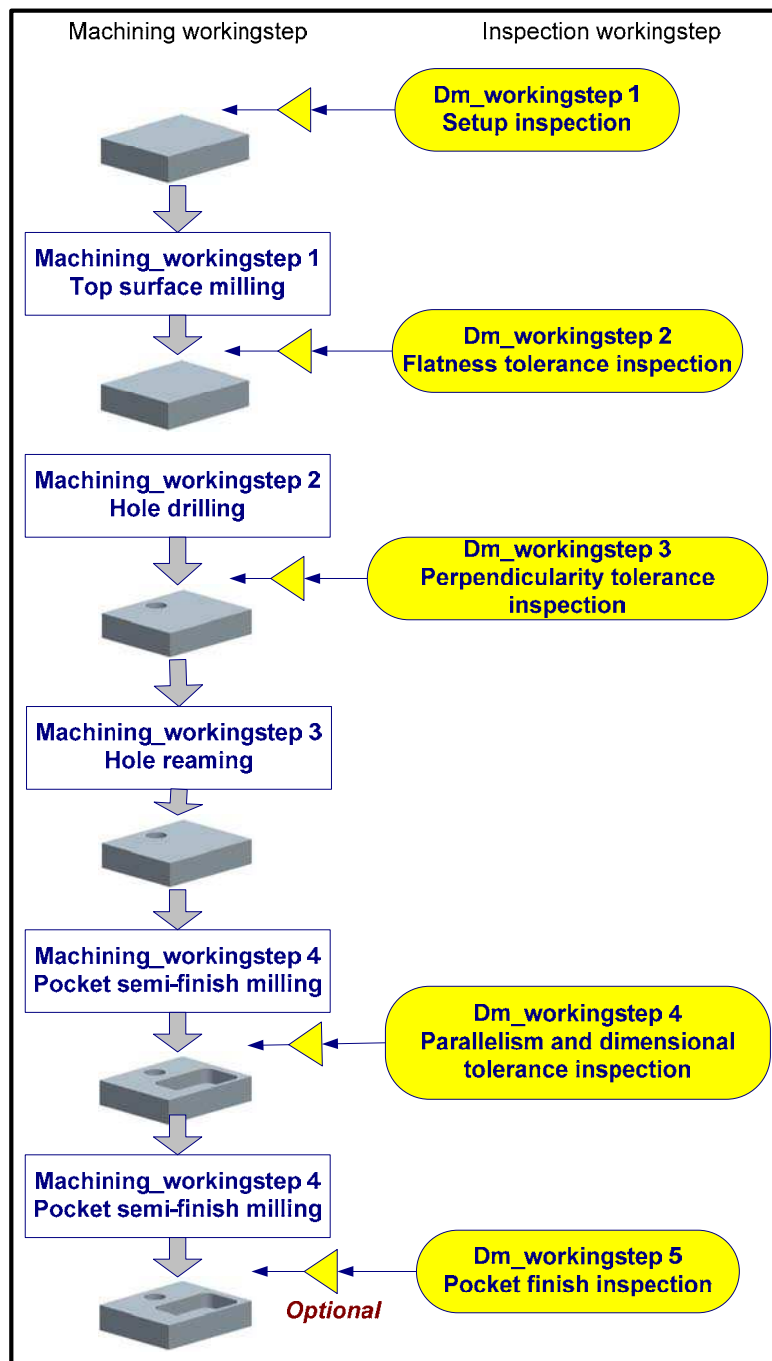

Figure 82: Machining and inspection workingsteps combined

Each of the inserted inspection workingsteps has a different purpose.

- 1) Dm\_workingstep 1 is to collect workpiece setup information, i.e. workpiece location and stock dimension information. Hence, it belongs to INSPECTION TYPE I.

- 2) Dm\_workingstep 2 is to inspect the top surface due to the tight flatness requirement. This inspection should not be left till the end as all other features (the hole and pocket) are machined from this surface. It is necessary to check this surface before subsequent machining operations. This is effectively INSPECTION TYPE II.
- 3) Dm\_workingstep 3 is carried out after the hole-drilling operation, due to the perpendicularity tolerance applied to the round hole. This dm\_workingstep serves the same purpose as dm\_workingstep 2.
- 4) Dm\_workingstep 4 is carried out after the semi-finish, pocket-milling operation for confirming the designed finishing allowance. Since the pocket bottom has a tight dimensional tolerance, it is necessary to have an inspection before the pocket finishing operation. The dimension allowance of the bottom surface is inspected and necessary adjustment is made to the final depth of cut. This is again of INSPECTION TYPE II.
- 5) Dm\_workingstep 5 is optional. This dm\_workingstep serves as the final inspection to check the conformance of the tight tolerances applied to the pocket feature. Therefore, it is of INSPECTION TYPE III.

The generated CMC file contains both machining and on-machine inspection operation commands. In Figure 81, the measurement points on each measuring feature are displayed as yellow crosses. Some of these points are not located on the workpiece. This is because the measured surface is removed by machining operations in the follow-up machining operations. The order of the machining and inspection workingsteps can be seen in the upper left section of the window. Figure 83 shows the real workpiece machined on a Mitsubishi 3-axis machine with the generated G codes.



**Figure 83: Machined workpiece of Example 1**

### 6.3.2. Cast Study 2

The first case study deals with simple independent machining features with multiple tolerances e.g. parallelism and dimensional tolerance on the closed pocket. The second case study considers more types of features and tolerances together with feature interaction situations.

This case study originally had thirteen machining\_workingsteps and seven geometric tolerances. The sequence of the machining\_workingsteps was in the following order (Figure 84) :

- 1) top surface finish milling
- 2) square open pocket rough milling
- 3) square open pocket finish milling
- 4) diagonal open pocket rough milling
- 5) diagonal open pocket finish milling
- 6) left closed pocket rough milling
- 7) right closed pocket rough milling
- 8) right closed pocket finish milling

- 9) step rough milling
- 10) step finish milling
- 11) slot rough milling
- 12) slot finish milling
- 13) hole drilling

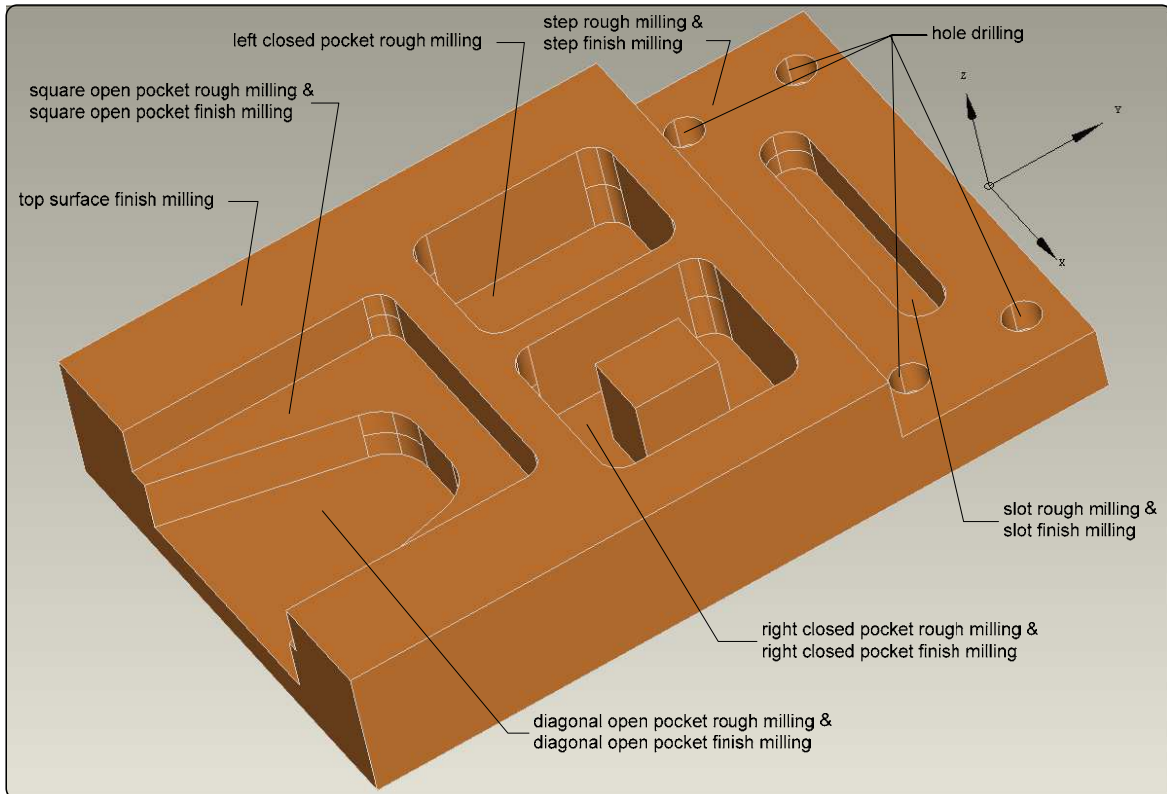

**Figure 84: Second case study workpiece and its machining\_workingsteps**

Among the seven geometric tolerances (shown in Figure 85) considered in this case study, three of them are new types of tolerances. They are the angularity tolerance applied to the diagonal open pocket, the symmetry tolerance applied to the square open pocket, and the position tolerances applied to the boss (in the right-hand side closed pocket) and the four round holes. The position tolerances on the closed pocket boss and the four round holes serve two types of tolerance control and constitute two different position tolerance cases. The position tolerances on the boss in the right-hand side closed pocket control the median faces of the two opposite plane surfaces of the boss.

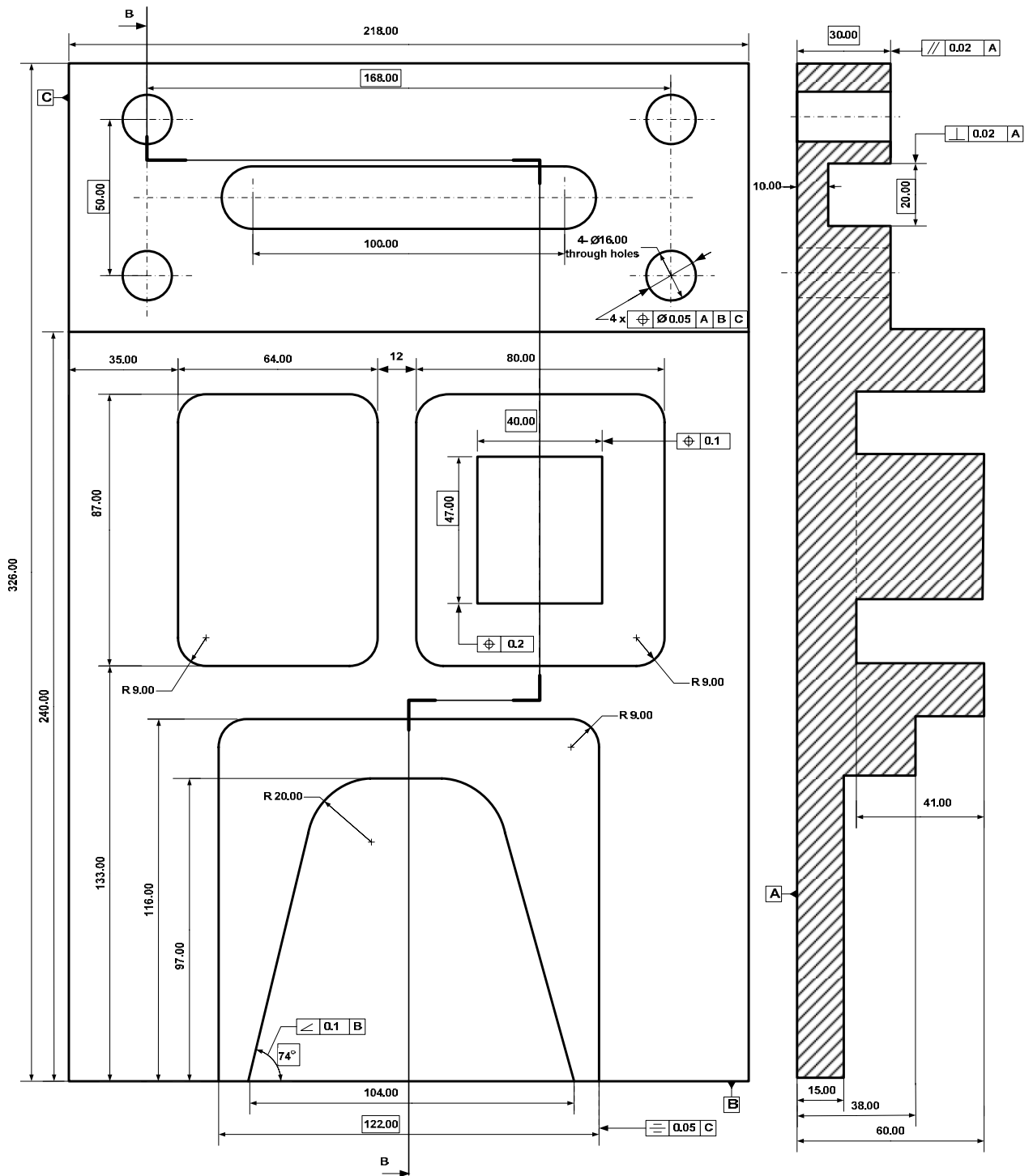

Figure 85: Second case study drawing

The position tolerances applied on the four round holes control the axis of each round hole. The tolerated geometry and tolerance zone for these two position tolerance are, therefore, different. For the former position tolerance, the tolerated\_geometry is a plane and the



tolerance zone is the space between two parallel planes of distance of the tolerance value. For the latter position tolerance, the `toleranced_geometry` is a cylinder and the tolerance zone is cylindrical with the diameter of the tolerance value.

This case study also tested the situation where one tolerance has multiple `toleranced_geometry`, e.g. the symmetry tolerance on the square open pocket, position tolerances on the boss, and the perpendicularity tolerance on the slot. Take the symmetry tolerance as an example: tolerance is applied on two sides of the open pocket to control the median plan. Therefore, each side of the square open pocket is a `toleranced_geometry`, in which case the geometry is a plane. The situations are similar to the position tolerances on the boss and the perpendicularity tolerance on the slot. Since the four side surfaces of the boss are controlled by two position tolerances, it presents a situation where one feature (a closed pocket with boss) has two applied tolerances and each tolerance has two `toleranced_geometry`.

Another notable situation considered in this case study is feature interaction. The developed feature interaction detection algorithm and the measurement points re-allocation algorithm (refer to Sections 5.4.2 and 5.4.3) are tested in this case study. Feature interaction occurs between the square open pocket and the diagonal open pocket interacts. The four round holes and the slot also interact with the step feature. Since the bottom of the square open pocket does not have tolerance applied to it, the interaction between the square open pocket and the diagonal open pocket is not detected by the feature interaction algorithm. However, because the step feature is controlled by a parallelism tolerance, the measurement points for inspecting this feature need to be checked by the feature interaction algorithm. If interaction occurs, the measurement points distributed on the virtual surface are to be re-allocated to a solid surface. In this case, the measurement points must not be located within the round holes and the slot. The software prototype successfully detects the interaction and re-allocates the measurement points to a solid surface for inspection.

Figure 86 shows the STEP-INSPEC software output of the second case study. This output is generated when all toleranced features are necessary to be inspected during machining process. In this case study, the interpreter of the software was further developed to be able

to generate CMC and G-code to machine step, closed pocket with boss, square open pocket, diagonal open pocket, and slot features. The G-code output was loaded on a Mitsubishi 3-axis machine to make the workpiece. Figure 87 shows the machined workpiece produced with the G-code generated from the STEP-INSPEC software prototype.

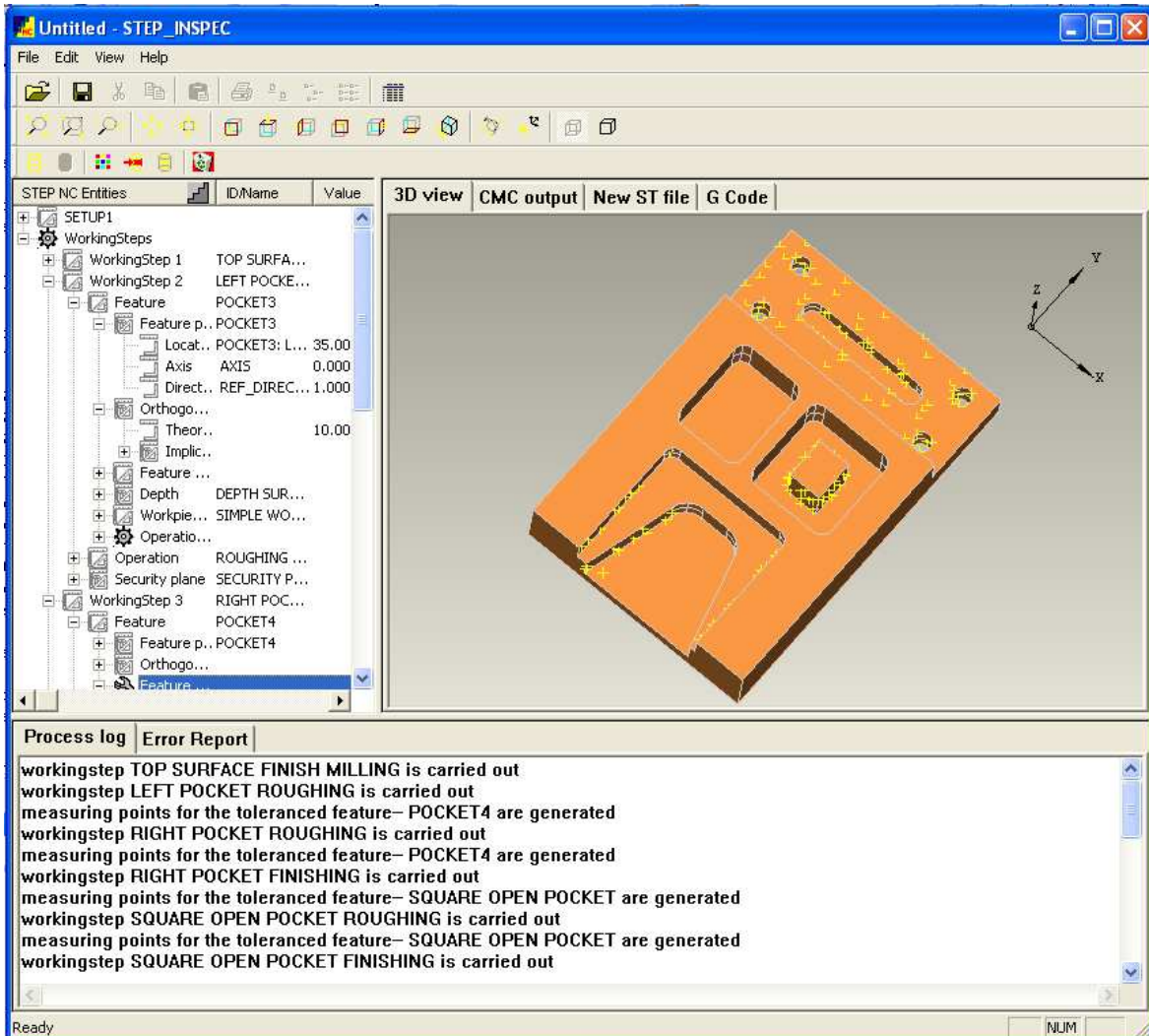

Figure 86: STEP-INSPEC software output for the second case study



**Figure 87: Machined workpiece of the second case study**

## 6.4. Recap

This chapter described the developed STEP-INSPEC software prototype. The software was developed under Microsoft Visual Studio 2005 environment using C++ programming language. Multiple software development tools and packages have been utilized and integrated in the STEP-INSPEC software. ST-Developer™ software has been used to convert EXPRESS schema into C++ classes and ROSE libraries, which are then integrated into STEP-INSPEC. Open CASCADE® is a 3D visualization software development tool package. Functions to generate 3D view have been used in STEP-INSPEC to display workpiece feature and measurement points. GSL libraries are used for linear algebra

calculation and least-square fitting, which is part of the data fitting implementation of the proposed system.

Two case studies have been carried out to test the proposed STEP Application Protocol ARM data model for integrated CNC machining and inspection. The data model has undergone extensive modifications during the case studies to verify the newly defined GD&T, measurement geometry, and measurement operation related information.

# *Chapter 7 Conclusions and Future Work*

Recognizing the deterministic nature of manufacturing operations paves the road for improvements in product quality and reduction of production costs. This is accomplished by measuring the important process parameters and performing appropriate adjustments in the system commands, through which a CLM system is formed. The elements necessary to form an efficient CLM system are an operational strategy or model that establishes acceptable limits of variability and the appropriate response when these conditions are exceeded, a means of measuring changes within the process, plus a mechanism for inputting the necessary corrective response. Three types of measurements exist in CLM systems serving three types of closed-loop in manufacturing systems. They are in-process measurement, in situ measurement, and remote measurement. Compared with in situ measurement and remote measurement, in-process measurement, commonly used for process control loop, has the benefits of being able to monitor manufacturing process in real time when a significant abnormality has occurred within a manufacturing cycle. In-process measurement can be used in two ways: process control (monitor key process parameters) and process qualification (monitor workpiece form/dimension acceptance). The data collected in both practices can be used in statistical analysis to improve manufacturing processes.

To facilitate process planning for in-process measurement with OMM operations and to utilize measurement data more efficiently, the input data needs to contain an explicit and complete representation of the product such as workpiece, features, and tolerance requirements. Only when based on this substantial product design information can the machining and inspection features be adequately identified, and associated machining and measurement operations be planned in an optimal order. Therefore, a consolidated data model including product definition information, machining process planning information,

machine tool and measurement sensor information becomes a must. This research focuses on the development of an automated in-process measurement system with OMM operations to monitor workpiece geometric and dimensional characteristics during machining processes. Measurement data is analysed immediately after inspection and updates are fed back to subsequent machining operation(s) for necessary changes. Among different types of measuring sensors, touch trigger probe is chosen for the measurement operations.

A thorough review of CAIPP was firstly carried out to identify the tasks that inspection process planning needs to accomplish. It is found that most of CAIPP systems/research focused on using CMMs to carry out inspections, which is effectively a post-process rather than an in-process activity. Very little research has concentrated on developing a CAIPP for in-process measurement.

CAIPP for both OMM and CMMs is largely isolated from machining process planning. CAIPP for OMM especially needs human intervention. Therefore, the inspection process does not effectively contribute to an efficient control of machining processes. To investigate why this kind of isolation exists, considering only CAIPP systems is not enough. It is vital to take a broader view – the dimensional metrology system – which CAIPP, as one of the four elements, belongs to. A detailed overview and discussion of dimensional metrology interoperability issues were given. It is clear that lack of interoperability exists between any two elements of dimensional metrology systems. These interoperability barriers are the main reason that CAIPP systems are isolated because only very limited information is provided to CAIPP. It was found that the current part inspection programs commonly generated by CAIPP systems are either based on DMIS or a vendor-specific bespoke routine. Also, the process control for both machining and OMM operation of components at the CNC machine tools is achieved through bespoke machining and inspection programs based on G&M codes. The low-level information that both G&M codes and DMIS language define means that CAIPP systems can not be fully integrated with either product definition or machining process planning systems. For example, GD&T requirements, which the essential information to make decision in CAIPP systems, are not fully defined and cannot be passed seamlessly from product definitions to the stage of CAIPP. Thus, measurement operators may need to either intervene process planning to

help choose measurement features for in-process measurement or to measure all features regardless of GD&T requirements in post-process measurement. Neither of them is ideal for modern industry.

This thesis described an automated process planning system that integrates machining and in-process measurement. To facilitate this proposal, developing a consolidated data model consisting of the information of GD&T, machining features and operations, inspection features and operations, and measuring devices is the first and foremost task to undertake. STEP/STEP-NC standards are by far the most comprehensive standards for product definitions throughout the lifecycle of a product. This characteristic makes them the best candidate to provide consolidated information for the proposed system. However, STEP/STEP-NC are relatively new standards; they are not complete and many parts of the standards are still under development. Some necessary information needed by the system is not defined in STEP/STEP-NC. Therefore, they are still unable to support automated inspection process planning integrated with machining process planning.

This research investigated the current Parts and drafts of STEP/STEP-NC and identified what additional information is needed. In fact, the inspection related, STEP/STEP-NC Parts and APs are incomplete, and many of them are still in drafting stage. Relevant CAIPP research focused mostly on testing the feasibility of the STEP data model for inspection process planning. Some of the research improved upon ISO 14649 Part 16 and AP 219. Among the reviewed research work, CMM is still the main method for carrying out measurement operations. In-process measurement was not considered. Based on the STEP/STEP-NC standard investigation, a STEP Application Protocol ARM data model for integrated CNC machining and inspection is developed in this research. The AAM model of the integrated process planning system is first developed to identify what information should the data model contain. Then, the data model is developed in three stages: investigating published STEP/STEP-NC Parts and APs, identifying and harmonizing existing inspection and machining process/operation information definitions, and augmenting the data model with the newly defined information. Product life management, measurement workingstep, measurement operation, and inspection feature information are all harmonized from existing STEP/STEP-NC Parts and APs. Information about the GD&T requirements, measurement resources and devices, probing approach and retract

strategy, measurement machine functions, measurement technology, measurement strategy, and measurement results are all newly defined in this research at the second stage of data model development. Apart from these new measurement related information definitions, this research proposes a mechanism to link machining feature and tolerance information, with which the STEP/STEP-NC data file is able to provide a consolidated data file for the integrated process planning scenario. Hence, production can be brought closer with measurement, which is what the industry is expected.

Provided with sufficient information, an integrated process planning system for machining and in-process measurement is then developed. It consists of four main sub-systems: measurement geometry selection/creation system, workingstep re-sequence system, micro inspection process planning system, and measurement result analysis and feedback system. The measurement geometry selection/creation system first processes the STEP data file through a tolerance filter, where critical tolerances are identified and related machining feature and toleranced geometry information (the geometry that has tolerance applied to) is traced; then, the developed measurement geometry decision-making rules make decisions on selecting measurement geometry for each critical tolerance. After selecting a proper measuring device, the workingstep for each measurement geometry is then inserted in-between machining workingsteps through the workingstep re-sequence system. The output of these two sub-systems is a new sequence of workingsteps with measurement workingstep embedded in-between machining workingsteps.

Each workingstep (machining and measurement) is then processed through the micro-level process planning system. This part of the research focused on micro inspection process planning for each measurement workingstep. The developed micro inspection process planning system consists of four sub-systems: the measurement points decision and distribution system, feature interaction detection system, measurement points reallocation system, and measurement points re-sequencing system. Measurement points and their distributions are first determined. Then, feature interaction detection is carried out to check whether the measurement geometry is interacted with other features/geometry. If interactions exist, the measurement points reallocation algorithm is called to reallocate those measurement points that are not located on solid surfaces. The measurement points are then finally re-sequenced through a TSP algorithm to generate the shortest probing



sequence for measurement execution. After each measurement operation is executed, the measurement results are fed into the data fitting system in the fourth sub-system of the proposed integrated process planning system, that is the measurement results analysis and feedback system. The “true” geometry is then generated and compared to the machining allowance and tolerance zone requirements in the input file. Necessary modifications to the subsequent machining operations are then generated. If the requirements are violated, the whole machining process will be terminated.

The developed STEP-INSPEC software prototype implemented the proposed integrated process planning system for machining and in-process measurement. The software is developed under the Microsoft Visual Studio 2005 environment using C++ programming language. Multiple software development tools and packages have been utilized and integrated into the STEP-INSPEC software. ST-Developer™ software is used to convert EXPRESS schema into C++ classes and ROSE libraries; they are then integrated into STEP-INSPEC. Open CASCADE® is a 3D visualization software development tool package. Functions to generate 3D view from Open CASCADE® have been used in STEP-INSPEC to display workpiece feature and measurement points. GSL libraries are used for linear algebra calculations and least-square fitting; both are part of the data fitting implementation of the proposed system. Two case studies have been carried out to test the proposed STEP Application Protocol ARM data model for integrated CNC machining and inspection, and also to test the STEP-INSPEC software prototype.

The data model and the integrated process planning system developed in this research provide valuable information for industry to bring machining and measurement closer than before. What is developed in this research is only a prototype. In order to test the comprehensiveness of the proposed data model, industry implementation is indispensable. Future research can be carried out in the following areas.

- 1) More types of geometric and dimensional tolerances with different machining features are to be considered.
- 2) The machine accuracy database needs to be further developed, for example to include more types of machine tools.

Since the STEP-INSPEC software is still a prototype, it only handles limited types of CNC machine tools. The machine accuracy database needs to include more types of machine tools. It is also necessary that shop-floor machine accuracy knowledge to be augmented into the current database.

- 3) The machining process planning system needs to be further developed.

Currently, the input file to the STEP-INSPEC software prototype has pre-process planned machining operations. A sophisticated machining process planning system should be integrated with this software prototype to conduct complete machining and measurement process planning.

- 4) A statistical analysis system can be developed to perform machine tool performance analysis and to update the machine tool database.

A very important feature of the developed integrated process planning system is to have real-time feedback/update to the process planner. This feature can be further developed to perform long-term statistical analysis and evaluation of machine tool performance. Thus, machine tool accuracy can be updated for more accurate in-process measurement process planning.

- 5) Integrated process planning needs to be further developed to suit different types of product quality controls.

The current integrated process planning considers one-off workpiece production. It can be further developed to suit batch production and cognitive manufacturing. One of the important features of the developed system is real-time acquisition of product and process data through in-process measurement and real-time feedback/update. This feature can be used to improve the current batch production process. For example, it is more sensible to carry out complete in-process measurements for each toleranced feature on a number of workpieces at the beginning of manufacturing process. Analysis of the measurement results will provide accurate information on machine status and characteristics. Based on this information, a process planning system is able to adjust its strategy to control those toleranced

features that are critical for the machine tool to produce. In this way, the integrated process planning system is performing an efficient and cognitive process planning for the manufacturing process.

---

# References

1. Zhao, Y.F., X. Xu, and S. Xie, *STEP-NC enabled on-line inspection in support of closed-loop machining*. Robotics and Computer-Integrated Manufacturing, 2008. **24**(2): p. 200-216.
2. Zhao, Y.F., X. Xu, and S.Q. Xie, *Computer-Aided Inspection Planning--The state of the art*. Computers in Industry, 2009. **60**(7): p. 453-466.
3. Zhao, Y.F., S. Habeeb, and X. Xu, *Research into integrated design and manufacturing based on STEP*. International Journal of Advanced Manufacturing Technology, 2009. **44**(5-6): p. 606-624.
4. Zhao, Y.F., X. Xu, and S.Q. Xie, *Integration of Machining and Inspection*. International Journal of Computer Aided Engineering and Technology, 2009. *in press*.
5. Zhao, Y.F., T. Kramer, F.M. Proctor, and J. Horst, *Dimensional Metrology Interoperability and Standardization in Manufacturing Systems*. Computer Standards & Interfaces, 2009. *in press*.
6. Zhao, Y.F., T. Kramer, F.M. Proctor, and J. Michaloski, *An Integrated Process Planning System Architecture for Machining and On-Machine Inspection*, in *Proceedings of the ASME 2008 International Design Engineering Technical Conferences & Computers and Information in Engineering Conference, IDETC/CIE 2008*. August 3-6, 2008: Brooklyn, New York, USA.
7. Zhao, Y.F., X.W. Xu, and S.Q. Xie, *Reactive Process Planning - Incorporating Machining, Inspection, and Feedback*, in *Proceedings of the ASME 2009 International Manufacturing Science and Engineering Conference, MSEC2009*. October 4-7, 2009: West Lafayette, Indiana, USA.
8. Barkman, W.E., *In-process Measurement*, in *Handbook of Industrial Automation*, E.L.H. Richard L. Shell, Editor. 2000, Marcel Dekker: New York.
9. Barkman, W.E., *In-Process Quality Control for Manufacturing*. 1989: New York : M. Dekker.
10. Jesse, C., *Process Controlled Manufacturing at Pratt & Whitney*. Society of Automotive Engineers transactions, 2001. **110**(01): p. 227-232.
11. Whitehouse, D., *Surfaces and Their Measurement*. 2002, London: Hermes Penton Ltd.

12. Kim, K.-D. and S.-C. Chung, *Synthesis of the measurement system on the machine tool*. International Journal of Production Research, 2001. **39**(11): p. 2475-2497.
13. Kamath, R., *On-Machine Inspection and Acceptance (OMIA)*. 2000, Master of Engineering Thesis, University of Missouri-Rolla, USA.
14. Cho, M.W., H. Lee, G.S. Yoon, and J.H. Choi, *A computer-aided inspection planning system for on-machine measurement - Part II: Local inspection planning*. KSME International Journal, 2004. **18**(8): p. 1358-1367.
15. Lee, H., M.W. Cho, G.S. Yoon, and J.H. Choi, *A Computer-aided inspection planning system for on-machine measurement - Part I: Global inspection planning*. KSME International Journal, 2004. **18**(8): p. 1349-1357.
16. Chung, S.C., *CAD/CAM integration of on-the-machine measuring and inspection system for free-formed surfaces*. Proceedings of American Society for Precision Engineering, 1999. **20**: p. 267-270.
17. Renishaw, *Renishaw Technical Specifications: Probing Systems for CNC Machine Tools*. 2000.
18. Davis, T.A., S. Carlson, W.E. Red, C.G. Jensen, and K. Sipfle, *Flexible in-process inspection through direct control*. Measurement: Journal of the International Measurement Confederation, 2006. **39**(1): p. 57-72.
19. Tönshoff, H.K. and I. Inasaki, *Sensors in Manufacturing*. Sensors Applications. 2001, Weinheim: WILEY-VCH Verlag GmbH.
20. ISO, *ISO 10303-1: Industrial automation systems and integration – Product data representation and exchange – Part 1: Industrial Automation System and Integration-Product Data Representation and Exchange Part 1: Overview and Fundamental Principles*. 1994.
21. ISO, *ISO 14649-1, Data model for Computerized Numerical Controllers: Part 1 Overview and fundamental principles*. 2002.
22. EIMaraghy, H.A. and W.H. EIMaraghy, *Computer-Aided Inspection Planning (CAIP)*, in *Advances in Feature Based Manufacturing*, J.J. Shah, Mäntylä, Martti , Nau, Dana S. , Editor. 1994, ELSEVIER SCIENCE b.v.: Amsterdam. p. 85-89.
23. Wong, F.S.Y., K.B. Chuah, and P.K. Venuvinod, *Automated inspection process planning: Algorithmic inspection feature recognition, and inspection case representation for CBR*. Robotics and Computer-Integrated Manufacturing, 2006. **22**(1): p. 56-68.
24. Li, Y. and P. Gu, *Free-form surface inspection techniques state of the art review*. CAD Computer Aided Design, 2004. **36**(13): p. 1395-1417.

25. ElMaraghy, H.A., P.H. Gu, and J.G. Bollinger, *Expert System for Inspection Planning*. CIRP Annals - Manufacturing Technology, 1987. **36**(1): p. 85-89.
26. Helmy, H.A., *Feature Recognition and CAD-Directed Inspection Using Solid Geometric Representation*. 1991, PhD Thesis, Lehigh University.
27. ANSI, *Dimensional Measuring Interface Standard, DMIS 5.0 Standard, Part 1, ANSI/CAM-I 105.0-2004, Part 1*. 2004.
28. Joshi, S. and T.C. Chang, *Graph-based heuristics for recognition of machined features from a 3D solid model*. Computer-Aided Design, 1988. **20**(2): p. 58-66.
29. Hopp, T.H. and R.J. Hocken, *CAD-Directed Inspection*. CIRP Annals - Manufacturing Technology, 1984. **33**(1): p. 357-361.
30. IBM, *Valisys - for quality in the making*. 1989.
31. Audimess, *VW-GEDAS: Graphic-interactive Programming System of CNC-coordinate Measuring Machines*. 1990.
32. Medland, A.J., *The Computer-Based Design Proces*. Second Edition ed. 1992: Chapman & Hall.
33. Medland, A.J., R. Singh, E. Sittas, and G. Mullineux, *Intelligent Communication between CAD and Manufacturing Activities*. in *Proceedings of the 28th MATADOR Conference*. 1990.
34. Medland, A.J. and G. Mullineux, *Strategies for Automatic Path Planning of Coordinate Measuring Machines*, in *24th CIRP International Seminar on Manufacturing Systems*. June 11-12, 1992.
35. Merat, F.L., G.M. Radack, K. Roumina, and S. Ruegsegger, *Automated inspection planning within the rapid design system*. in *IEEE International Conference on Systems Engineering*. 1991.
36. Yau, H.-T. and C.-H. Menq, *Path planning for automated dimensional inspection using coordinate measuring machines*, in *Proceedings - IEEE International Conference on Robotics and Automation*. 1991. p. 1934-1939.
37. Menq, C.-H., H.-T. Yau, and C.-L. Wong, *Intelligent planning environment for automated dimensional inspection using coordinate measuring machines*. Journal of engineering for industry, 1992. **114**(2): p. 222-230.
38. Yau, H.-T. and C.-H. Menq, *Automated dimensional inspection environment for manufactured parts using coordinate measuring machines*. International Journal of Production Research, 1992. **30**(7): p. 1517-1536.

39. Tannock, J.D.T., H. Lee, and J.H.S. Williams, *Intelligent inspection planning and computer aided inspection*. Proceedings of the Institution of Mechanical Engineers, Part B: Journal of Engineering Manufacture, 1993. **207**(B2): p. 99-104.
40. Brown, C.W. and D.A. Gyorog, *Generative inspection process planner for integrated production*, in *American Society of Mechanical Engineers, Production Engineering Division (Publication) PED*. 1990. p. 151-162.
41. Duffie, N., J. Bollinger, R. Piper, and M. Kroneberg, *CAD Directed Inspection and Error Analysis Using Surface Patch Databases*. CIRP Annals - Manufacturing Technology, 1984. **33**(1): p. 347-350.
42. Menq, C.-H., H.-T. Yau, and G.-Y. Lai, *Automated precision measurement of surface profile in CAD-directed inspection*. IEEE Transactions on Robotics and Automation, 1992. **8**(2): p. 268-278.
43. Cho, M.W. and K. Kim, *New inspection planning strategy for sculptured surfaces using coordinate measuring machine*. International Journal of Production Research, 1995. **33**(2): p. 427 - 444.
44. Corrigall, M.J. and Bell, R., *An Inspection Plan and Code Generation for Coordinate Measuring Machines*, in *Proceedings of 9th International Conference of Automated Inspection and Product Control*. 1989. p. 145-154.
45. Corrigall, M.J., *Inspection Plan and Code Generation for Coordinate Measuring Machines in a Product Modeling Environment*. 1990, PhD Thesis, Loughborough University of Technology.
46. Sira, *Design to Inspection Project*, Sira Ltd. 1992.
47. Bogue, R., *Car manufacturer uses novel laser scanner to reduce time to production*. Assembly Automation, 2008. **28**(2): p. 113-114.
48. Vezzetti, E., *Reverse engineering: A selective sampling acquisition approach*. International Journal of Advanced Manufacturing Technology, 2007. **33**(5-6): p. 521-529.
49. Minoni, U. and F. Cavalli, *Surface quality control device for on-line applications*. Measurement: Journal of the International Measurement Confederation, 2008. **41**(7): p. 774-782.
50. Aguilar, J.J., J. Santolaria, D. Guillomia, J. Pastor, and C. Cajal, *Accuracy analysis of laser scanning probes used in coordinate measurement: Simulation and experiments*, in *VDI Berichte*. 2004. p. 739-744+797.
51. Zhang, S.G., A. Ajmal, J. Wootton, and A. Chisholm, *Feature-based inspection process planning system for co-ordinate measuring machine (CMM)*. Journal of Materials Processing Technology, 2000. **107**(1-3): p. 111-118.

52. Vafaeesefat, A. and H.A. Elmaraghy, *Automated accessibility analysis and measurement clustering for CMMs*. International Journal of Production Research, 2000. **38**(10): p. 2215-2231.
53. Limaiem, A. and H.A. Elmaraghy, *CATIP: A computer-aided tactile inspection planning system*. International Journal of Production Research, 1999. **37**(2): p. 447-465.
54. Hwang, C.Y., C.Y. Tsai, and C.A. Chang, *Efficient inspection planning for coordinate measuring machines*. International Journal of Advanced Manufacturing Technology, 2004. **23**(9-10): p. 732-742.
55. Elkott, D.F., H.A. ElMaraghy, and W.H. ElMaraghy, *Automatic sampling for CMM inspection planning of free-form surfaces*. International Journal of Production Research, 2002. **40**(11): p. 2653-2676.
56. Woo, T. and Liang, R., *Optimal Sampling for Coordinate Measurement: Its Definition and Algorithm*. Quality Through Engineering Design, 1993: p. 333-346.
57. Zhang, Y.F., A.Y.C. Nee, J.Y.H. Fuh, K.S. Neo, and H.K. Loy, *A neural network approach to determining optimal inspection sampling size for CMM*. Computer Integrated Manufacturing Systems, 1996. **9**(3): p. 161-169.
58. Cho, M.W., H. Lee, G.S. Yoon, and J. Choi, *A feature-based inspection planning system for coordinate measuring machines*. International Journal of Advanced Manufacturing Technology, 2005. **26**(9-10): p. 1078-1087.
59. Jiang, B.C. and S.D. Chiu, *Form tolerance-based measurement points determination with CMM*. Journal of Intelligent Manufacturing, 2002. **13**(2): p. 101-108.
60. Menq, C.-H., H.-T. Yau, G.-Y. Lai, and R.A. Miller, *Statistical evaluation of form tolerances using discrete measurement data*. in *American Society of Mechanical Engineers, Production Engineering Division (Publication) PED*. 1990.
61. Hocken, R.J., J. Raja, and U. Babu, *Sampling issues in coordinate metrology*. Manufacturing Review, 1993. **6**(4): p. 282-294.
62. Fan, K.-C. and M.C. Leu, *Intelligent planning of CAD-directed inspection for coordinate measuring machines*. Computer Integrated Manufacturing Systems. **11**(1-2): p. 43-51.
63. Lee, G.L. and J. Mou, *Design the sampling strategy for dimensional measurement of geometric features using coordinate measuring machine*, in *Proceedings of the Japan/USA Symposium on Flexible Automation*. 1996. p. 1193-1200.
64. Lee, G., J. Mou, and Y. Shen, *Sampling strategy design for dimensional measurement of geometric features using coordinate measuring machine*. International Journal of Machine Tools and Manufacture, 1997. **37**(7): p. 917-934.



65. Pahk, H.J., M.Y. Jung, S.W. Hwang, Y.H. Kim, Y.S. Hong, and S.G. Kim, *Integrated precision inspection system for manufacturing of moulds having CAD defined features*. The International Journal of Advanced Manufacturing Technology, 1995. **10**(3): p. 198-207.
66. Orady, E., Y. Chen, S. Li, and A. El-Baghdady, *A fuzzy decision-making system for CMM measurements in quality control*. The 2000 Pacific Conference on Manufacturing, 2000.
67. Kim, W.S. and S. Raman, *On the selection of flatness measurement points in coordinate measuring machine inspection*. International Journal of Machine Tools and Manufacture, 2000. **40**(3): p. 427-443.
68. Fang, K.T., S.G. Wang, and G. Wei, *A stratified sampling model in spherical feature inspection using coordinate measuring machines*. Statistics and Probability Letters, 2001. **51**(1): p. 25-34.
69. Kim, D. and T. Ozsoy, *New sampling strategies for form evaluation of free form surfaces*. Proceedings of the 1999 ASME Design Engineering Technical Conference, 1999.
70. Edgeworth, R. and R.G. Wilhelm, *Adaptive sampling for coordinate metrology*. Precision Engineering, 1999. **23**(3): p. 144-154.
71. Dowling, M.M., P.M. Griffin, K.L. Tsui, and C. Zhou, *Statistical issues in geometric feature inspection using coordinate measuring machines*. Technometrics, 1997. **39**(1): p. 3-17.
72. Hwang, I., H. Lee, and S. Ha, *Hybrid neuro-fuzzy approach to the generation of measuring points for knowledge-based inspection planning*. International Journal of Production Research, 2002. **40**(11): p. 2507-2520.
73. Caskey, G., Y. Hari, R. Hocken, D. Palanivelu, J. Raja, R. Wilson, K. Chen, and J. Yang, *Sampling techniques for coordinate measuring machines*. Design and Manufacturing Systems Conference, 1990: p. 779-786.
74. Caskey, G., Y. Hari, R. Hocken, R. Machireddy, J. Raja, R. Wilson, G. Zhang, K. Chen, and J. Yang, *Sampling techniques for coordinate measuring machines*. Proceedings of the NSF Design and Manufacturing Systems Conference, 1992: p. 983-988.
75. Albuquerque, V.A., F.W. Liou, and O.R. Mitchell, *Inspection point placement and path planning algorithms for automatic CMM inspection*. International Journal of Computer Integrated Manufacturing, 2000. **13**(2): p. 107-120.
76. Ainsworth, I., M. Ristic, and D. Brujic, *CAD-based measurement path planning for free-form shapes using contact probes*. International Journal of Advanced Manufacturing Technology, 2000. **16**(1): p. 23-31.

77. Lin, Y.J. and P. Murugappan, *New algorithm for CAD-directed CMM dimensional inspection*. International Journal of Advanced Manufacturing Technology, 2000. **16**(2): p. 107-112.
78. Cho, M.W. and T.I. Seo, *Inspection planning strategy for the on-machine measurement process based on CAD/CAM/CAI integration*. International Journal of Advanced Manufacturing Technology, 2002. **19**(8): p. 607-617.
79. Wong, F.S.Y., K.B. Chuah, and P.K. Venuvinod, *Automated extraction of dimensional inspection features from part computer-aided design models*. International Journal of Production Research, 2005. **43**(12): p. 2377-2396.
80. Yuen, C.F., S.Y. Wong, and P.K. Venuvinod, *Development of a generic computer-aided process planning support system*. Journal of Materials Processing Technology, 2003. **139**(1-3 SPEC): p. 394-401.
81. Horst, J., *Make interoperability happen*. Quality, 2005. **44**(11): p. 42-45.
82. Proctor, F., B. Rippey, J. Horst, J. Falco, T. Kramer, *Interoperability testing for shop floor measurement*. in *Performance Metrics for Intelligent Systems (PerMIS) Workshop*. 2007.
83. IMTI, *A Roadmap for Metrology Interoperability 2006*, Integrated Manufacturing Technology Initiative (IMTI, Inc.).
84. ISO, *ISO 10303-203: Industrial automation systems and integration – Product data representation and exchange – Part 203: Application Protocols: Configuration controlled 3D design*. 2007.
85. ISO, *ISO 10303-224: Industrial automation systems and integration -Product data representation and exchange - Part 224: Application protocol: Mechanical product definition for process planning using machining features*. 2006.
86. STEP Tools Ltd., July 2009 [cited; Available from: <http://www.steptools.com/>].
87. ISO, *ISO 10303-214: Industrial automation systems and integration -Product data representation and exchange - Part 214: Application Protocol: Core data for automotive mechanical design processes*. 2001.
88. Chalmers, R.E., *Metrology for manufacturing means business*. Manufacturing Engineering, 2002. **128**(4).
89. NIST. *DMIS Test Suite 2.1.4*, 2009 [cited; Available from: [http://www.isd.mel.nist.gov/projects/metrology\\_interoperability/dmis\\_test\\_suite.htm](http://www.isd.mel.nist.gov/projects/metrology_interoperability/dmis_test_suite.htm)]

90. ISO, *ISO 10360-1: Geometrical Product Specifications (GPS) -- Acceptance and reverification tests for coordinate measuring machines (CMM) -- Part 1: Vocabulary*. 2000.
91. ANSI, *Dimensional Measuring Interface Standard Part 2 : Object Interface Specification, Consortium for Advanced Manufacturing - International*. 2003.
92. I++DME, *Dimensional Measurement Equipment Interface, the International Association of Coordinate Measuring Machine Manufacturers*. 2005.
93. DML. *Dimensional Markup Language (DML)*. 2009 [cited; Available from: <http://www.dmlspec.org/>].
94. ISO, *ISO 10303-219, Industrial automation systems and integration-Product data representation and exchange-Part 219: Application protocol: Dimensional inspection information exchange*. 2004.
95. ISO, *ISO 10303-238: Industrial automation systems and integration – Product data representation and exchange - Part 238: Application Protocols: Application interpreted model for computerized numerical controllers*. 2004.
96. ASQ. *American Society for Quality*. July 2009 [cited; Available from: <http://www.asq.org/>].
97. ISO, *ISO/TS 16949:2009 Quality management systems -- Particular requirements for the application of ISO 9001:2008 for automotive production and relevant service part organizations*. 2009.
98. ISO, *ISO 6983/1, Numerical control of machines – Program format and definition of address words – Part 1: Data format for positioning, line and contouring control systems*. 1982.
99. ISO, *ISO 10303-21:Industrial automation systems and integration -- Product data representation and exchange -- Part 21: Implementation methods: Clear text encoding of the exchange structure*. 2002.
100. Kramer, T.R. and X. Xu, *STEP in a Nutshell*, in *Advanced Design and Manufacturing Based on STEP*, X. Xu, Editor. 2009. p. 1-19.
101. Xu, X. and Y. C. Andrew, editors, *Advanced Design and Manufacturing Based on STEP*. 2009, Springer.
102. Wang, H.Q., *New Control Strategy for CNC Machines Via STEP-NC*, Department of Mechanical Engineering. 2009, PhD Thesis, the University of Auckland: Auckland.
103. SC4, I. 2008 [cited; Available from: <http://www.tc184-sc4.org/>].

104. Fowler, J., *STEP for data management, exchange and sharing*. Technology Appraisals, 1995: p. 109-119.
105. Wosnik, M., et al., *Enabling feedback of process data by use of STEP-NC*. International Journal of Computer Integrated Manufacturing, 2006. **19**(6): p. 559-569.
106. Heusinger, S., et al., *Integrating the CAx process chain for STEP-compliant NC manufacturing of asymmetric parts*. International Journal of Computer Integrated Manufacturing, 2006. **19**(6): p. 533-545.
107. Xu, X., et al., *STEP-compliant process planning and manufacturing*. International Journal of Computer Integrated Manufacturing, 2006. **19**(6): p. 491-494.
108. ISO, *ISO 10303-11: Industrial automation systems and integration – Product data representation and exchange – Part 11: Description methods: The EXPRESS language reference manual*. 2004.
109. ISO, *ISO 10303-22: Industrial automation systems and integration -- Product data representation and exchange -- Part 22: Implementation methods: Standard data access interface*. 1998.
110. ISO, *ISO 10303-23: Industrial automation systems and integration -- Product data representation and exchange -- Part 23: Implementation methods: C++ language binding of the standard data access interface*. 1998.
111. ISO, *ISO 10303-24: Industrial automation systems and integration -- Product data representation and exchange -- Part 24: Implementation methods: C language binding of the standard data access interface*. 1998.
112. ISO, *ISO 10303-27: Industrial automation systems and integration -- Product data representation and exchange -- Part 27: Implementation methods: Java TM programming language binding to the standard data access interface with Internet/Intranet extensions*. 1998.
113. ISO, *ISO 10303-28: Industrial automation systems and integration -- Product data representation and exchange -- Part 28: Implementation methods: XML representations of EXPRESS schema and data*. 2002.
114. ISO, *ISO 10303-28: Industrial automation systems and integration -- Product data representation and exchange -- Part 28: Implementation methods: XML representations of EXPRESS schema and data*. 2004.
115. ISO, *ISO 10303-101: Industrial automation systems and integration -- Product data representation and exchange -- Part 101: Integrated application resources: Draughting* 1994.

116. ISO, *ISO 10303-105: Industrial automation systems and integration -- Product data representation and exchange -- Part 105: Integrated application resource: Kinematics* 1996.
117. ISO, *ISO 10303-107: Industrial automation systems and integration -- Product data representation and exchange -- Part 107: Integrated application resource -- Finite element analysis definition relationships* 2006.
118. ISO, *ISO 14649-10: Industrial automation systems and integration -- Physical device control -- Data model for computerized numerical controllers -- Part 10: General process data.* 2004.
119. ISO, *ISO 14649-11: Industrial automation systems and integration -- Physical device control -- Data model for computerized numerical controllers -- Part 11: Process data for milling.* 2004.
120. ISO, *ISO 14649-12: Industrial automation systems and integration -- Physical device control -- Data model for computerized numerical controllers -- Part 12: Process data for turning.* 2005.
121. ISO, *ISO 14649-111: Data model for Computerized Numerical Controllers --Part 111: Tools for Milling Machines.* 2004.
122. ISO, *ISO 14649-121: Data model for Computerized Numerical Controllers --Part 121: Tools for Turning Machines.* 2003.
123. ISO, *ISO 10303-240: Industrial automation systems and integration -Product data representation and exchange - Part 240: Application protocol: Process plans for machined products.* 2005.
124. Wang, H. and X.W. Xu, *A STEP-compliant 'adaptor' for linking CAPP with CNC.* 34th International MATADOR Conference, July 7-9, 2004.
125. Kramer, T.R., *Automatic generation of NC-code for hole cutting with in-process metrology.* 1989. p. 45-52.
126. Xu, X.W. and S.T. Newman, *Making CNC machine tools more open, interoperable and intelligent - A review of the technologies.* Computers in Industry, 2006. **57**(2): p. 141-152.
127. Lin, Z.C. and J.J. Chow, *Integration planning model of IDEF0 and STEP product data representation methods in a CMM measuring system.* International Journal of Advanced Manufacturing Technology, 2001. **17**(1): p. 39-53.
128. Kramer, T.R., H. Huang, E. Messina, F.M. Proctor, and H. Scott, *A feature-based inspection and machining system.* CAD Computer Aided Design, 2001. **33**(9): p. 653-669.

129. Brecher, C., M. Vitr, and J. Wolf, *Closed-loop CAPP/CAM/CNC process chain based on STEP and STEP-NC inspection tasks*. International Journal of Computer Integrated Manufacturing, 2006. **19**(6): p. 570-580.
130. Suh, S.H., E.S. Lee, H.C. Kim, and J.H. Cho, *Geometric error measurement of spiral bevel gears using a virtual gear model for STEP-NC*. International Journal of Machine Tools and Manufacture, 2002. **42**(3): p. 335-342.
131. Ali, L., S.T. Newman, and J. Petzing, *Development of a STEP-compliant inspection framework for discrete components*. Proceedings of the Institution of Mechanical Engineers, Part B: Journal of Engineering Manufacture, 2005. **219**(7): p. 557-563.
132. ISO, *ISO 14649-16:Data model for Computerized Numerical Controllers — Part 16: Data for touch probing based inspection*. 2004.
133. ISO, *ISO/TS 10303-1012:2008 Industrial automation systems and integration -- Product data representation and exchange -- Part 1012: Application module: Approval*. 2008.
134. ISO, *ISO/TS 10303-1015:2004 Industrial automation systems and integration -- Product data representation and exchange -- Part 1015: Application module: Security classification*. 2004.
135. ISO, *ISO 10303-47: Industrial automation systems and integration – Product data representation and exchange – Part 47: Integrated generic resource: Shape variation tolerances*. 1997.
136. Xu, X., *Integrating advanced computer-aided design, manufacturing, and numerical control : principles and implementations*. 2009, Hershey, PA: Information Science Reference.
137. Rauch, M., E. Duc, and J.Y. Hascoet, *Improving trochoidal tool paths generation and implementation using process constraints modelling*. International Journal of Machine Tools and Manufacture, 2009. **49**(5): p. 375-383.
138. MAZAK. 2009 [cited; Available from: <http://www.mazakusa.com/pdfs/MZK-1079.pdf>].
139. Machining, F.W. 2009 [cited; Available from: <http://www.fwmachining.com/Equip2009.htm>].
140. ISO, *ISO 1101:2004, Geometrical Product Specifications (GPS) -- Geometrical tolerancing--Tolerances of form, orientation, location, and run-out*. 2004.
141. ANSI, *ASME Y14.5M-1994: Dimensioning and Tolerancing*. 1994.
142. Henzold, G., *Handbook of Geometrical Tolerancing*. 1995, West Sussex: John Wiley & Sons Ltd.

- 
143. BS, *BS 7172—Guide to assessment of position, size, and departure from nominal form of geometric features, the minimum number of points*. 1989.
  144. Boukreev, K. *Genetic algorithms and the Traveling Salesman Problem*. 26 September, 2001 [cited; Available from: <http://www.codeproject.com/KB/recipes/tspapp.aspx>].
  145. Feng, S.C. and T.H. Hopp, *A Review of Current Geometric Tolerancing Theories and Inspection Data Analysis Algorithms*. National Institute of Standards and Technology, 1991(NISTIR 4509).
  146. Forbes, A.B., *Least-Square Best-Fit geometric elements*. 1989, National Physical Laboratory: Teddington, United Kingdom.
  147. C++. 2009 [cited; Available from: [http://en.wikipedia.org/wiki/Microsoft\\_Visual\\_Studio](http://en.wikipedia.org/wiki/Microsoft_Visual_Studio)].
  148. OpenCASCADE. 2009 [cited; Available from: <http://www.opencascade.org/>].
  149. GSL. 2009 [cited; Available from: <http://www.gnu.org/software/gsl/>].
  150. Frederick M. Proctor, T.R.K., John L. Michaloski, *Canonical Machining Commands*, in *National Institute of Standards and Technology, Intelligent Systems Division*. 1997.
  151. Fishhead. 2009 [cited; Available from: [http://www.steptools.com/library/stepnc/2008\\_sweden/](http://www.steptools.com/library/stepnc/2008_sweden/)].

# *Appendix A EXPRESS-G*

## *Diagram of Proposed Data Model*

Appendix A includes three EXPRESS-G diagrams of the proposed STEP ARM data model. In Chapter 4, these diagrams are broken down into small diagrams due to the page size constrain. The connection between these definitions are shown clearer in the following figures. Figure 88 shows GD&T, toleranced geometry, and datum definitions as well as their connections. Figure 89 shows measurement workingstep and operation related information definitions and their connections including measurement technology, measurement machine function, measurement strategy, measurement result, and probing approach and retract strategy. Figure 90 shows dimensional measurement feature definitions.



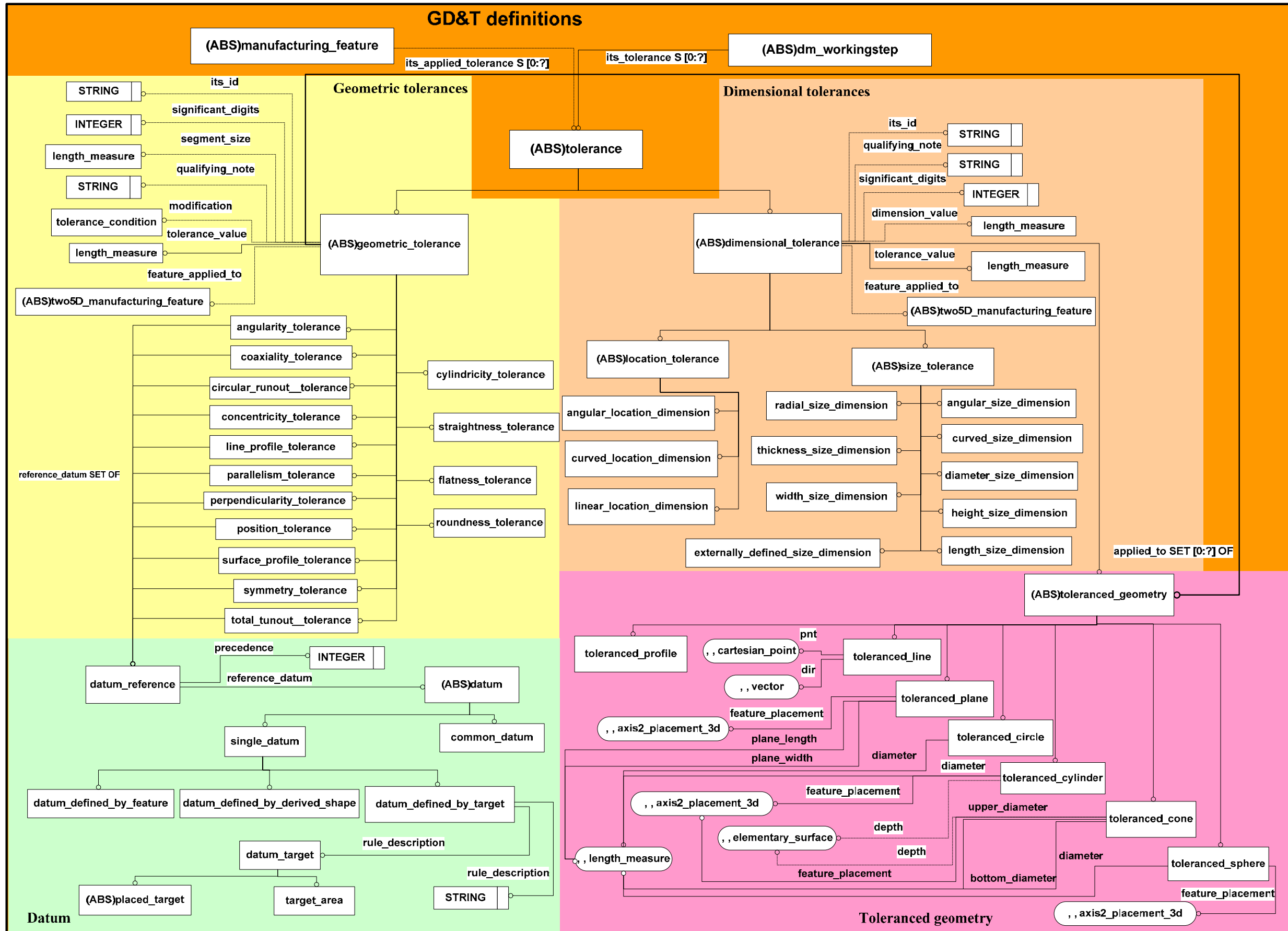

Figure 88: EXPRESS-G diagram of proposed GD&T, datum, and toleranced geometry definitions.

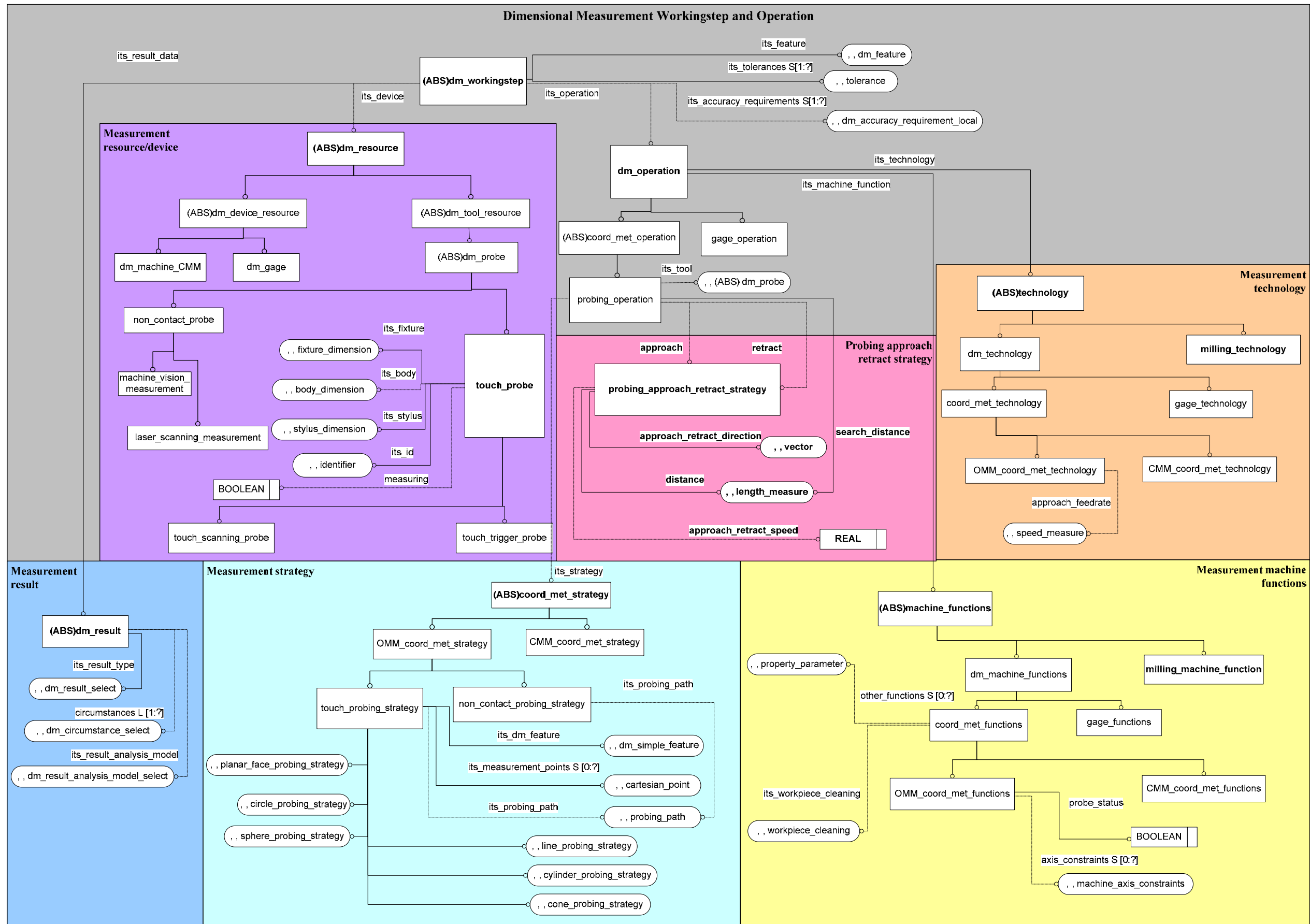

Figure 89: EXPRESS-G diagram of proposed measurement workingstep, operation, technology, strategy, machine function, result definitions

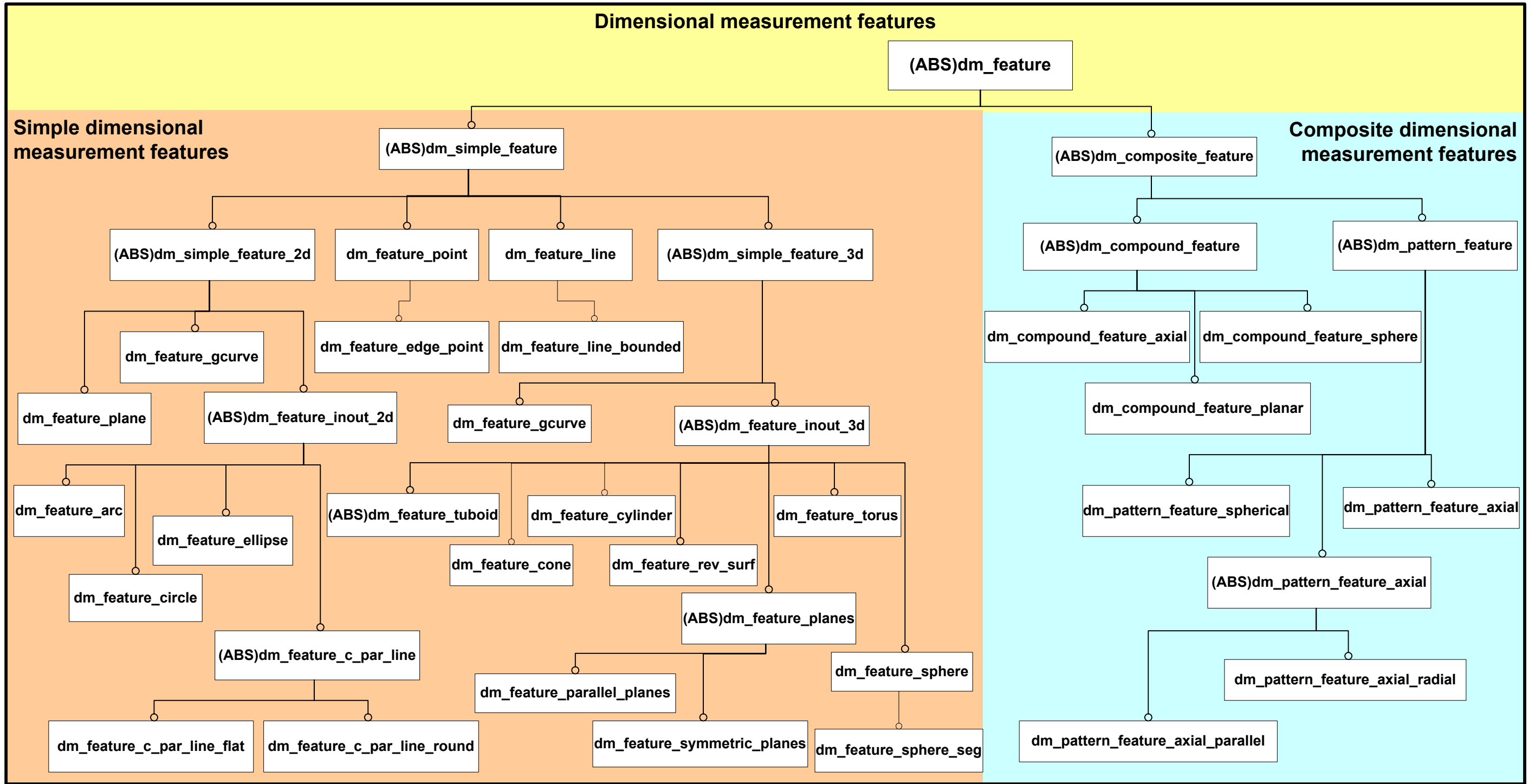

Figure 90: EXPRESS-G diagram of proposed dimensional measurement feature definitions

## *Appendix B STEP-NC programs*

The Examples included in Appendix B is the STEP-NC file of the two case studies carried out in this research. The first case study – Example 1 from ISO 14649 Part 11 – is listed in Appendix B.1. The second case study – Fish-head roughing example – is listed in Appendix B.2.

## Appendix B.1 ISO 14649 Part 11 Example 1

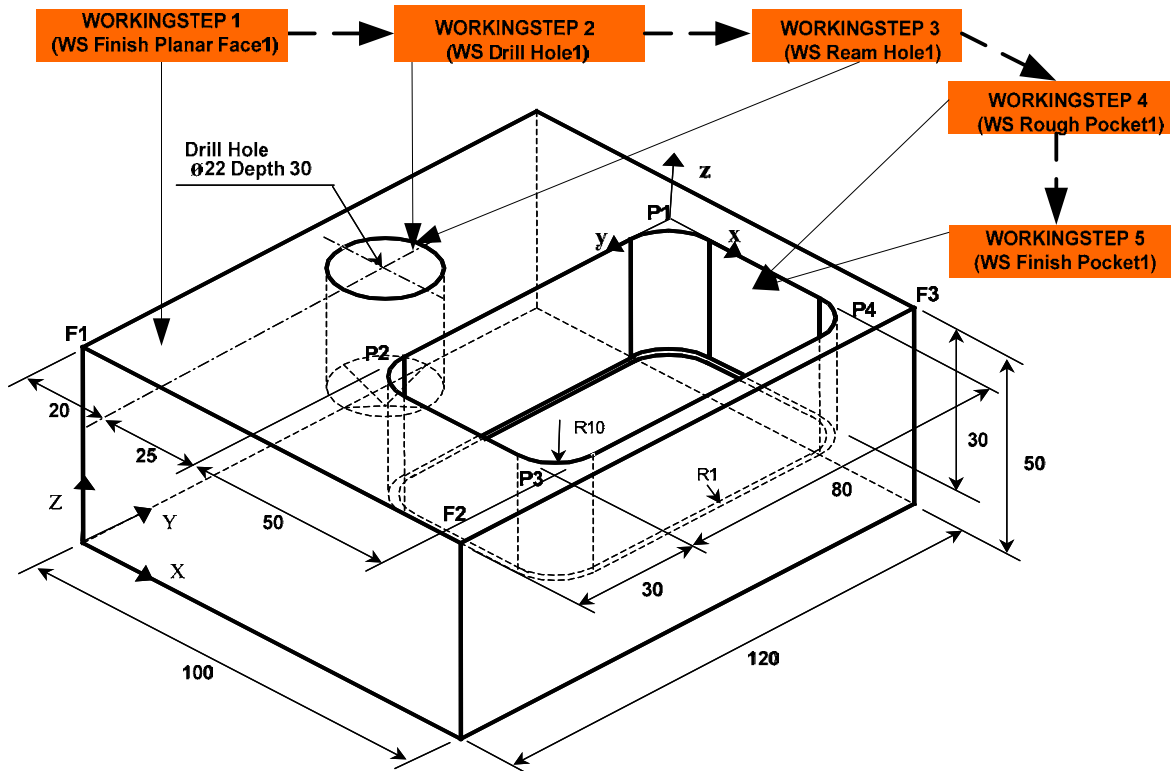

Figure 91: ISO 14649 Part 11 Example 1

```

ISO-10303-21;
HEADER;
/* Generated by software containing ST-Developer
 * from STEP Tools, Inc. (www.steptools.com)
 */

FILE_DESCRIPTION(
/* description */ ('ISO 14649-11 EXAMPLE 1',
'SIMPLE PROGRAM WITH A PLANAR_FACE, A POCKET, AND A ROUND_HOLE'),
/* implementation_level */ '2;1');

FILE_NAME(
/* name */ 'EXAMPLE1.STP',
/* time_stamp */ '2009-11-06T11:02:43+13:00',
/* author */ ('Fiona Zhao, Xun Xu'),
/* organization */ ('University of Auckland, NZ'),
/* preprocessor_version */ 'ST-DEVELOPER v12',
/* originating_system */ 'ISO 14649',
/* authorisation */ '$);

FILE_SCHEMA (('MACHINING_SCHEMA','MILLING_SCHEMA'));
ENDSEC;

DATA;
#10=TOLERANCED_CYLINDER('PERPENDICULARITY TOLERANCED HOLE',#126,#20,22.);

```

```
#11=TOLERANCED_PLANE('POCKET DEPTH TOLERANCED PLANE',#134,80.,50.,$);
#12=TOLERANCED_PLANE('POCKET PARALLELISM TOLERANCED PLANE',#132,80.,30.,
$);
#13=TOLERANCED_PLANE('FLATNESS TOLERANCED PLANAR FACE',#133,120.,100.,$);
#14=HEIGHT_SIZE_DIMENSION($,#11,#38,$,30.,$,0.002,$,$);
#15=STYLUS_DIMENSION($,50.,6.,6.,$, $);
#16=BODY_DIMENSION(0.,0.);
#17=FIXTURE_DIMENSION(50.,40.);
#18=TOUCH_TRIGGER_PROBE('PROBE NUM01',$, #17,#16, (#15));
#19=PLANE('PLANAR_FACE1-DEPTH PLANE',#125);
#20=PLANE('DEPTH SURFACE FOR ROUND HOLE1',#127);
#21=PLANE('DEPTH SURFACE FOR POCKET1',#129);
#22=PLANE('SECURITY PLANE',#122);
#23=PLANE('POCKET PARALLELISM TOLERANCED PLANE',#130);
#24=PROJECT('EXECUTE EXAMPLE1',#25, (#26), (#18), $, $, $);
#25=WORKPLAN('MAIN WORKPLAN', (#31,#34,#35,#32,#33), $, #29, $);
#26=WORKPIECE('SIMPLE WORKPIECE',#27,0.01,$,$,$, (#103,#104,#105,#106));
#27=MATERIAL('ST-50', 'STEEL', (#28));
#28=PROPERTY_PARAMETER('E=200000N/M2');
#29=SETUP('SETUP1',#121,#22, (#30));
#30=WORKPIECE_SETUP(#26,#123,$,$, ());
#31=MACHINING_WORKINGSTEP('WS FINISH PLANAR_FACE1',#22,#36,#39,$);
#32=MACHINING_WORKINGSTEP('WS DRILL HOLE1',#22,#37,#40,$);
#33=MACHINING_WORKINGSTEP('WS REAM HOLE1',#22,#37,#41,$);
#34=MACHINING_WORKINGSTEP('WS ROUGH POCKET1',#22,#38,#42,$);
#35=MACHINING_WORKINGSTEP('WS FINISH POCKET1',#22,#38,#43,$);
#36=PLANAR_FACE('PLANAR_FACE1',#26, (#39), #124, (#139), #19, #44, #45, $, ());
#37=ROUND_HOLE('HOLE1 D=22MM',#26, (#40, #41), #126, (#140), #20, #56, $, #46);
#38=CLOSED_POCKET('POCKET1',#26, (#42, #43), #128, (#143, #14), #21, (, $, #47, $,
#54, #138);
#39=PLANE_FINISH_MILLING($,$, 'FINISH PLANAR_FACE1',10., $, #63, #66, #71, $,
#101, #102, #72, 2.5, $);
#40=DRILLING($,$, 'DRILL HOLE1',10., $, #64, #67, #71, $, $, $, $, $, #96);
#41=REAMING($,$, 'REAM HOLE1',10., $, #65, #68, #71, $, $, $, $, $, #97, .T., $, $);
#42=BOTTOM_AND_SIDE_ROUGH_MILLING($,$, 'ROUGH POCKET1',15., $, #63, #69, #71,
$, $, $, #98, 6.5, 5., 1., 0.5);
#43=BOTTOM_AND_SIDE_FINISH_MILLING($,$, 'FINISH POCKET1',15., $, #63, #70,
#71, $, $, $, #99, 2., 10., $, $);
#44=LINEAR_PATH($, #55, #74);
#45=LINEAR_PROFILE($, #100);
#46=THROUGH_BOTTOM_CONDITION();
#47=PLANAR_POCKET_BOTTOM_CONDITION();
#48=TAPERED_ENDMILL(#49, 4, .RIGHT., .F., $, $);
#49=MILLING_TOOL_DIMENSION(18., $, $, 29., 0., $, $);
#50=MILLING_TOOL_DIMENSION(20., 31., 0.1, 45., 2., 5., 8.);
#51=MILLING_TOOL_DIMENSION(22., $, $, 40., $, $, $);
#52=TWIST_DRILL(#50, 2, .RIGHT., .F., 0.84);
#53=TAPERED_REAMER(#51, 6, .RIGHT., .F., $, $);
#54=TOLERANCED_LENGTH_MEASURE(10., #60);
#55=TOLERANCED_LENGTH_MEASURE(120., #61);
#56=TOLERANCED_LENGTH_MEASURE(22., #61);
#57=TOLERANCED_LENGTH_MEASURE(50., #59);
#58=TOLERANCED_LENGTH_MEASURE(80., #60);
#59=PLUS_MINUS_VALUE(0.1, 0.1, 3);
#60=PLUS_MINUS_VALUE(0.1, 0.1, 3);
#61=PLUS_MINUS_VALUE(0.3, 0.3, 3);
#62=PLUS_MINUS_VALUE(0.025, 0.025, 4);
#63=MILLING_CUTTING_TOOL('MILL 18MM', #48, (#135), 80., $, $);
```

```

#64=MILLING_CUTTING_TOOL('SPIRAL_DRILL_20MM',#52,(#136),90.,$,,$);
#65=MILLING_CUTTING_TOOL('REAMER_22MM',#53,(#137),100.,$,,$);
#66=MILLING_TECHNOLOGY(0.04,.TCP.,$, -12.,$, .F.,.F.,.F.,$);
#67=MILLING_TECHNOLOGY(0.03,.TCP.,$, -16.,$, .F.,.F.,.F.,$);
#68=MILLING_TECHNOLOGY(0.03,.TCP.,$, -18.,$, .F.,.F.,.F.,$);
#69=MILLING_TECHNOLOGY(0.04,.TCP.,$, -20.,$, .F.,.F.,.F.,$);
#70=MILLING_TECHNOLOGY(0.04,.TCP.,$, -20.,$, .F.,.F.,.F.,$);
#71=MILLING_MACHINE_FUNCTIONS(.T.,$, $, .F.,$, (), .T.,$, $, ());
#72=BIDIRECTIONAL_MILLING(0.05,.T.,#73,.LEFT.,$);
#73=DIRECTION('STRATEGY PLANAR FACE1: 1.DIRECTION',(0.,1.,0.));
#74=DIRECTION('COURSE OF TRAVEL DIRECTION',(0.,1.,0.));
#75=DIRECTION(' AXIS ',(0.,0.,1.));
#76=DIRECTION(' REF_DIRECTION',(1.,0.,0.));
#77=DIRECTION(' AXIS ',(0.,0.,1.));
#78=DIRECTION(' REF_DIRECTION',(1.,0.,0.));
#79=DIRECTION(' AXIS ',(0.,0.,1.));
#80=DIRECTION(' REF_DIRECTION',(1.,0.,0.));
#81=DIRECTION(' AXIS ',(0.,0.,1.));
#82=DIRECTION(' REF_DIRECTION',(1.,0.,0.));
#83=DIRECTION(' AXIS ',(0.,0.,1.));
#84=DIRECTION(' REF_DIRECTION',(1.,0.,0.));
#85=DIRECTION(' AXIS ',(0.,0.,1.));
#86=DIRECTION(' AXIS ',(0.,0.,1.));
#87=DIRECTION(' REF_DIRECTION',(1.,0.,0.));
#88=DIRECTION(' AXIS ',(0.,0.,1.));
#89=DIRECTION(' REF_DIRECTION',(1.,0.,0.));
#90=DIRECTION(' AXIS ',(0.,0.,1.));
#91=DIRECTION(' REF_DIRECTION',(1.,0.,0.));
#92=DIRECTION(' AXIS ',(1.,0.,0.));
#93=DIRECTION(' REF_DIRECTION',(0.,1.,0.));
#94=DIRECTION(' AXIS ',(1.,0.,0.));
#95=DIRECTION(' REF_DIRECTION',(0.,0.,-1.));
#96=DRILLING_TYPE_STRATEGY(0.75,0.5,2.,0.5,0.75,8.);
#97=DRILLING_TYPE_STRATEGY($,$,$,$,$,$);
#98=CONTOUR_PARALLEL($,$,.CW.,.CONVENTIONAL.);
#99=CONTOUR_PARALLEL(0.05,.T.,.CW.,.CONVENTIONAL.);
#100=NUMERIC_PARAMETER('PROFILE LENGTH',100.,'MM');
#101=PLUNGE_TOOLAXIS($);
#102=PLUNGE_TOOLAXIS($);
#103=CARTESIAN_POINT('CLAMPING_POSITION1',(0.,20.,25.));
#104=CARTESIAN_POINT('CLAMPING_POSITION2',(100.,20.,25.));
#105=CARTESIAN_POINT('CLAMPING_POSITION3',(0.,100.,25.));
#106=CARTESIAN_POINT('CLAMPING_POSITION4',(100.,100.,25.));
#107=CARTESIAN_POINT('SETUP1: LOCATION ',(0.,0.,0.));
#108=CARTESIAN_POINT('SECPLANE1: LOCATION ',(0.,0.,30.));
#109=CARTESIAN_POINT('WORKPIECE1:LOCATION ',(0.,0.,0.));
#110=CARTESIAN_POINT('PLANAR FACE1:LOCATION ',(0.,0.,5.));
#111=CARTESIAN_POINT('PLANAR FACE1:DEPTH ',(0.,0.,-5.));
#112=CARTESIAN_POINT('HOLE1: LOCATION ',(20.,60.,0.));
#113=CARTESIAN_POINT('HOLE1: DEPTH ',(0.,0.,-30.));
#114=CARTESIAN_POINT('POCKET1: LOCATION ',(45.,30.,0.));
#115=CARTESIAN_POINT('POCKET1: DEPTH ',(0.,0.,-30.));
#116=CARTESIAN_POINT('POCKET PARALLELISM TOLERANCED PLANE:LOCATION',(45.,
30.,0.));
#117=CARTESIAN_POINT('POCKET DEPTH TOLERANCED PLANE:LOCATION',(0.,0.,
-30.));
#118=CARTESIAN_POINT('POCKET PARALLELISM TOLERANCED PLANE:LOCATION',(45.,
30.,0.));

```

```
#119=CARTESIAN_POINT('FLATNESS TOLERANCED PLANAR FACE:LOCATION ',(0.,0.,
0.));
#120=CARTESIAN_POINT('POCKET DEPTH TOLERANCED PLANE:LOCATION',(45.,30.,-
30.));
#121=AXIS2_PLACEMENT_3D('SETUP1',#107,#75,#76);
#122=AXIS2_PLACEMENT_3D('PLANE1',#108,#77,#78);
#123=AXIS2_PLACEMENT_3D('WORKPIECE',#109,#79,#80);
#124=AXIS2_PLACEMENT_3D('PLANAR FACE1',#110,#81,#82);
#125=AXIS2_PLACEMENT_3D('PLANAR FACE1',#111,#83,#84);
#126=AXIS2_PLACEMENT_3D('HOLE1',#112,#85,#87);
#127=AXIS2_PLACEMENT_3D('HOLE1',#113,#86,#87);
#128=AXIS2_PLACEMENT_3D('POCKET1',#114,#88,#89);
#129=AXIS2_PLACEMENT_3D('POCKET1',#115,#90,#91);
#130=AXIS2_PLACEMENT_3D('POCKET PARALLELISM TOLERANCED PLANE',#116,#92,
#93);
#131=AXIS2_PLACEMENT_3D('POCKET DEPTH TOLERANCED PLANE',#117,#81,#82);
#132=AXIS2_PLACEMENT_3D('POCKET PARALLELISM TOLERANCED PLANE',#118,#94,
#95);
#133=AXIS2_PLACEMENT_3D('FLATNESS TOLERANCED PLANAR FACE',#119,#81,#82);
#134=AXIS2_PLACEMENT_3D('POCKET DEPTH TOLERANCED PLANE',#120,#81,#82);
#135=CUTTING_COMPONENT(50.,$, $, $, $);
#136=CUTTING_COMPONENT(70.,$, $, $, $);
#137=CUTTING_COMPONENT(50.,$, $, $, $);
#138=RECTANGULAR_CLOSED_PROFILE($,#57,#58);
#139=FLATNESS_TOLERANCE('FLATNESS TOLERANCED PLANAR FACE',(#13),#36,$,$,
$, $,0.005);
#140=PERPENDICULARITY_TOLERANCE('PERPENDICULARITY TOLERANCED POCKET',
(#10),#37,$,$,$,$,0.003,$,(#142),$);
#141=DATUM_DEFINED_BY_FEATURE('DATUM PLANE B',$,'BLOCK PLANE B');
#142=DATUM_REFERENCE(1,#141);
#143=PARALLELISM_TOLERANCE('PARALLELISM TOLERANCED POCKET',(#12),#38,$,$,
$, $,0.0025,$,(#142),$);
ENDSEC;
END-ISO-10303-21;
```



## Appendix B.2 Fish-head Roughing Example

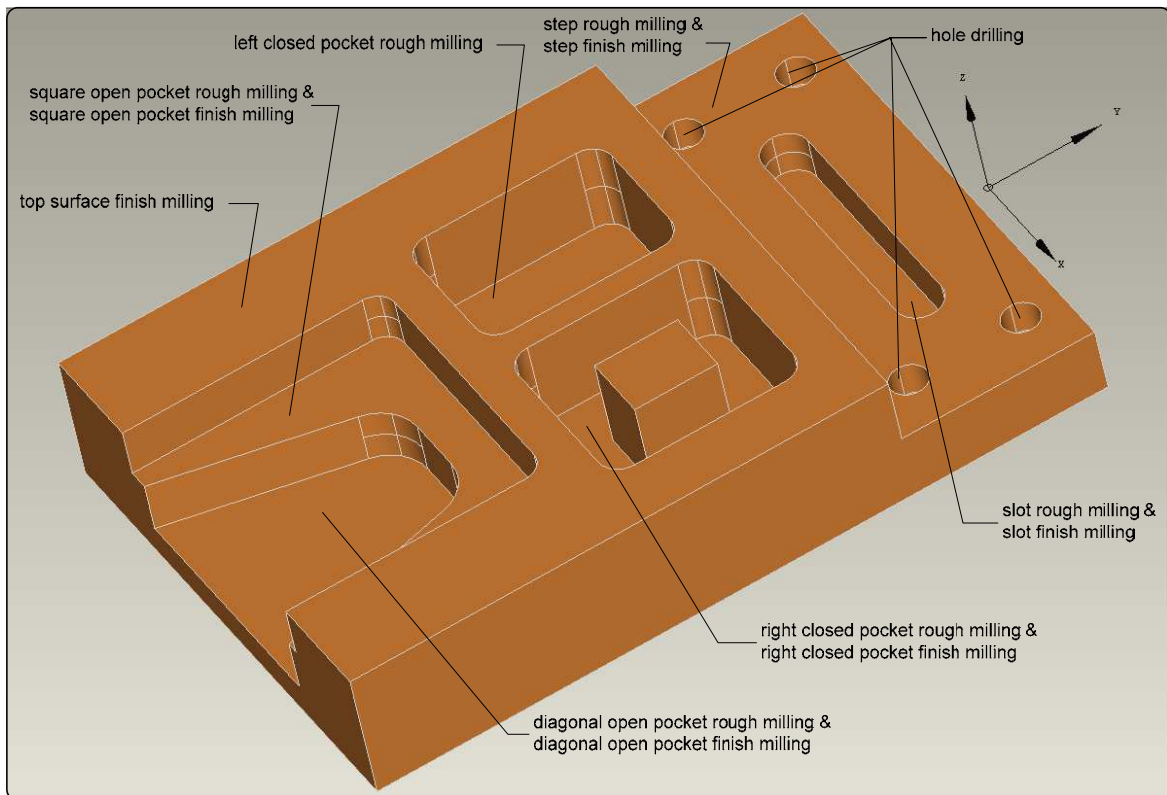

**Figure 92: Fish-head roughing example**

```
ISO-10303-21;
HEADER;
/* Generated by software containing ST-Developer
 * from STEP Tools, Inc. (www.steptools.com)
 */

FILE_DESCRIPTION(
/* description */ ('Fish-head roughing example',
'Workpiece with Two5D machining features'),
/* implementation_level */ '2;1');

FILE_NAME(
/* name */ 'EXAMPLE1.STP',
/* time_stamp */ '2009-03-20T20:35:02+13:00',
/* author */ ('Fiona Zhao','Xun Xu'),
/* organization */ ('University of Auckland'),
/* preprocessor_version */ 'ST-DEVELOPER v11',
/* originating_system */ 'STEP-Manufacturing',
/* authorisation */ $);

FILE_SCHEMA (('MACHINING_SCHEMA','MILLING_SCHEMA'));
ENDSEC;

DATA;
```

```

#10=POLYLINE('CONTOUR OF POCKET1',(#57,#58,#59,#60));
#11=POLYLINE('CONTOUR OF POCKET2',(#61,#62,#63,#64));
#12=GENERAL_PROFILE($,#10);
#13=GENERAL_PROFILE($,#11);
#14=OPEN_POCKET('SQUARE OPEN
POCKET',#108,(#122,#957),#32,(#980),#105,(),$,#141,$,#152,#12,$);
#980=SYMMETRY_TOLERANCE('SYMMETRY TOLERANCE ON SQUARE OPEN POCKET',
    (#981,#991),#14,$,$,$,$,0.05,$,(#982),$);
#981=TOLERANCED_PLANE('SYMMETRY TOLERANCED PLANE1',#983,116,22.,());
#983=AXIS2_PLACEMENT_3D('SYMMETRY TOLERANCED PLANE1',#984,#985,#986);
#984=CARTESIAN_POINT('SYMMETRY TOLERANCED PLANE1: LOCATION ',
    (48.,0.,0.));
#985=DIRECTION(' AXIS ',(1.,0.,0.));
#986=DIRECTION(' REF_DIRECTION',(0.,-1.,0.));
#982=DATUM_REFERENCE(1.,#987);
#987=DATUM_DEFINED_BY_FEATURE('DATUM PLANE C',$,'BLOCK PLANE C');
#991=TOLERANCED_PLANE('SYMMETRY TOLERANCED PLANE2',#993,116,22.,());
#993=AXIS2_PLACEMENT_3D('SYMMETRY TOLERANCED PLANE2',#994,#995,#996);
#995=DIRECTION(' AXIS ',(-1.,0.,0.));
#996=DIRECTION(' REF_DIRECTION',(0.,-1.,0.));
#994=CARTESIAN_POINT('SYMMETRY TOLERANCED PLANE2: LOCATION ',
    (170.,0.,0.));
#970=ANGULARITY_TOLERANCE('ANGULARITY TOLERANCE ON DIAGONAL OPEN POCKET',
    (#971),#15,$,$,$,$,0.1,$,(#972),$);
#971=TOLERANCED_PLANE('ANGULARITY TOLERANCED PLANE',#973,85.35,23.,());
#973=AXIS2_PLACEMENT_3D('ANGULARITY TOLERANCED PLANE',#974,#975,#976);
#974=CARTESIAN_POINT('ANGULARITY TOLERANCED PLANE: LOCATION ',(57.,0.,
    -22.));
#975=DIRECTION(' AXIS ',(1.,0.,0.));
#976=DIRECTION(' REF_DIRECTION',(0.,-1.,0.));
#972=DATUM_REFERENCE(1.,#977);
#977=DATUM_DEFINED_BY_FEATURE('DATUM PLANE B',$,'BLOCK PLANE B');
#15=OPEN_POCKET('DIAGONAL OPEN POCKET',#108,(#920,#963),#34,(#970),#106,
    (),$,#141,$,#154,#13,$);
#16=PROJECT('EXECUTE EXAMPLE1',#17,(#108),(#250),$,$,$);
#250=TOUCH_TRIGGER_PROBE('PROBE NUM01',$,#251,#252,(#253));
#251=FIXTURE_DIMENSION(50.,40.);
#252=BODY_DIMENSION(0.,0.);
#253=STYLUS_DIMENSION($,50.,6.,6.,$,$);
#17=WORKPLAN('MAIN WORKPLAN',(#955,#113,#114,#956,#116,#961,#117,#962,
    #200,#964,#400,#967,#600,#700,#800,#900),$,#18,$);
#18=SETUP('SETUP1',#19,#99,(#107));
#19=AXIS2_PLACEMENT_3D('SETUP1',#36,#65,#66);
#20=AXIS2_PLACEMENT_3D('PLANE1',#37,#67,#68);
#21=AXIS2_PLACEMENT_3D('WORKPIECE',#42,#69,#70);
#26=AXIS2_PLACEMENT_3D('POCKET3',#47,#79,#80);
#27=AXIS2_PLACEMENT_3D('POCKET3',#48,#81,#82);
#28=AXIS2_PLACEMENT_3D('POCKET4',#49,#83,#84);
#29=AXIS2_PLACEMENT_3D('POCKET4',#50,#85,#86);
#32=AXIS2_PLACEMENT_3D('SQUARE OPEN POCKET',#53,#91,#92);
#33=AXIS2_PLACEMENT_3D('SQUARE OPEN POCKET',#54,#93,#94);
#34=AXIS2_PLACEMENT_3D('DIAGONAL OPEN POCKET',#55,#95,#96);
#35=AXIS2_PLACEMENT_3D('DIAGONAL OPEN POCKET',#56,#97,#98);
#36=CARTESIAN_POINT('SETUP1: LOCATION ',(0.,0.,0.));
#37=CARTESIAN_POINT('SECPANE1: LOCATION ',(0.,0.,30.));
#38=CARTESIAN_POINT('CLAMPING_POSITION1',(0.,20.,25.));
#39=CARTESIAN_POINT('CLAMPING_POSITION2',(100.,20.,25.));
#40=CARTESIAN_POINT('CLAMPING_POSITION3',(0.,100.,25.));

```

```

#41=CARTESIAN_POINT('CLAMPING_POSITION4', (100.,100.,25.));
#42=CARTESIAN_POINT('WORKPIECE1:LOCATION ', (0.,0.,0.));
#47=CARTESIAN_POINT('POCKET3: LOCATION ', (35.,133.,0.));
#48=CARTESIAN_POINT('POCKET3: DEPTH ', (35.,133.,-41.));
#49=CARTESIAN_POINT('POCKET4: LOCATION ', (111.,133.,0.));
#50=CARTESIAN_POINT('POCKET4: DEPTH ', (111.,133.,-41.));
#53=CARTESIAN_POINT('SQUARE OPEN POCKET: LOCATION ', (48.,0.,0.));
#54=CARTESIAN_POINT('SQUARE OPEN POCKET: DEPTH ', (48.,0.,-22.));
#55=CARTESIAN_POINT('DIAGONAL OPEN POCKET: LOCATION ', (57.,0.,-22.));
#56=CARTESIAN_POINT('DIAGONAL OPEN POCKET: DEPTH ', (57.,0.,-23.));
#57=CARTESIAN_POINT('P1', (0.,0.,0.));
#58=CARTESIAN_POINT('P2', (0.,116.,0.));
#59=CARTESIAN_POINT('P3', (122.,116.,0.));
#60=CARTESIAN_POINT('P4', (122.,0.,0.));
#61=CARTESIAN_POINT('P1', (0.,0.,0.));
#62=CARTESIAN_POINT('P2', (26.,97.,0.));
#63=CARTESIAN_POINT('P3', (82.,97.,0.));
#64=CARTESIAN_POINT('P4', (108.,0.,0.));
#65=DIRECTION(' AXIS ', (0.,0.,1.));
#66=DIRECTION(' REF_DIRECTION', (1.,0.,0.));
#67=DIRECTION(' AXIS ', (0.,0.,1.));
#68=DIRECTION(' REF_DIRECTION', (1.,0.,0.));
#69=DIRECTION(' AXIS ', (0.,0.,1.));
#70=DIRECTION(' REF_DIRECTION', (1.,0.,0.));
#79=DIRECTION(' AXIS ', (0.,0.,1.));
#80=DIRECTION(' REF_DIRECTION', (1.,0.,0.));
#81=DIRECTION(' AXIS ', (0.,0.,1.));
#82=DIRECTION(' REF_DIRECTION', (1.,0.,0.));
#83=DIRECTION(' AXIS ', (0.,0.,1.));
#84=DIRECTION(' REF_DIRECTION', (1.,0.,0.));
#85=DIRECTION(' AXIS ', (0.,0.,1.));
#86=DIRECTION(' REF_DIRECTION', (1.,0.,0.));
#91=DIRECTION(' AXIS ', (0.,0.,1.));
#92=DIRECTION(' REF_DIRECTION', (1.,0.,0.));
#93=DIRECTION(' AXIS ', (0.,0.,1.));
#94=DIRECTION(' REF_DIRECTION', (1.,0.,0.));
#95=DIRECTION(' AXIS ', (0.,0.,1.));
#96=DIRECTION(' REF_DIRECTION', (1.,0.,0.));
#97=DIRECTION(' AXIS ', (0.,0.,1.));
#98=DIRECTION(' REF_DIRECTION', (1.,0.,0.));
#99=PLANE('SECURITY PLANE', #20);
#102=PLANE('DEPTH SURFACE FOR POCKET3', #27);
#103=PLANE('DEPTH SURFACE FOR POCKET4', #29);
#105=PLANE('DEPTH SURFACE FOR SQUARE OPEN POCKET', #33);
#106=PLANE('DEPTH SURFACE FOR DIAGONAL OPEN POCKET', #35);
#107=WORKPIECE_SETUP(#108, #21, $, $, ());
#108=WORKPIECE('SIMPLE WORKPIECE', #110, 0.01, $, $, $, (#38, #39, #40, #41));
#109=PROPERTY_PARAMETER('E=200000N/M2');
#110=MATERIAL('ST-50', 'STEEL', (#109));
#113=MACHINING_WORKINGSTEP('LEFT POCKET ROUGHING', #99, #120, #122, $);
#114=MACHINING_WORKINGSTEP('RIGHT POCKET ROUGHING', #99, #121, #122, $);
#116=MACHINING_WORKINGSTEP('SQUARE OPEN POCKET ROUGHING', #99, #14, #122, $);
#117=MACHINING_WORKINGSTEP('DIAGONAL OPEN POCKET ROUGHING', #99, #15, #920,
$);
#956=MACHINING_WORKINGSTEP('RIGHT POCKET FINISHING', #99, #121, #957, $);
#957=BOTTOM_AND_SIDE_FINISH_MILLING($, $, 'FINISHING POCKET', 15., $, #124,
#958, #959, #207, #208, $, #960, 12., 13., $, $);
#958=MILLING_TECHNOLOGY(0.04, .TCP., $, -20., $, .F., .F., .F., $);

```

```

#959=MILLING_MACHINE_FUNCTIONS(.T.,$,,$,.F.,$,(),.T.,$,,$,());
#960=CONTOUR_PARALLEL(0.05,.T.,.CW.,.CONVENTIONAL.);
#961=MACHINING_WORKINGSTEP('SQUARE OPEN POCKET FINISHING',#99,#14,#957,$)
;
#962=MACHINING_WORKINGSTEP('DIAGONAL OPEN POCKET FINISHING',#99,#15,#963,
$);
#963=BOTTOM_AND_SIDE_FINISH_MILLING($,$,'FINISHING DIAGONAL POCKET',15.,
$, #921, #958, #959, #207, #208, $, #960, 2., 10., $, $);
#964=MACHINING_WORKINGSTEP('STEP FINISHING',#99,#201,#965,$);
#965=BOTTOM_AND_SIDE_FINISH_MILLING($,$,'FINISHING STEP',15.,$, #921, #958,
#959, #207, #208, $, #933, 12., 13., $, $);
#967=MACHINING_WORKINGSTEP('SLOT FINISH MILLING',#99,#301,#968,$);
#968=BOTTOM_AND_SIDE_FINISH_MILLING($,$,'SLOT FINISHING',15.,$, #402, #958,
#959, #207, #208, $, #406, 12, 13., $, $);
#402=MILLING_CUTTING_TOOL('MILL 20MM',#403,(#405),80.,$, $);
#403=TAPERED_ENDMILL(#404,4,.RIGHT.,.F.,$, $);
#404=MILLING_TOOL_DIMENSION(20.,$, $, 29., 0., $, $);
#405=CUTTING_COMPONENT(60.,$, $, $, $);
#120=CLOSED_POCKET('POCKET3',#108,(#122),#26,(),#102,(),$, #141,$, #142,
#170);
#121=CLOSED_POCKET('POCKET4',#108,(#122,#957),#28,(#410,#422),#103,(#500)
,$, #141,$, #142,#171);
#410=POSITION_TOLERANCE('POSITION TOLERANCE ON BOSS',(#411,#417),#121,$,
$, $, $, 0.1,$, (), $);
#411=TOLERANCED_PLANE('POSITION TOLERANCED PLANE ON BOSS1',#412,37.,41.,
());
#412=AXIS2_PLACEMENT_3D('POSITION TOLERANCED PLANE ON BOSS1',#413,#414,
#415);
#413=CARTESIAN_POINT('POSITION TOLERANCED PLANE ON BOSS1: LOCATION ',
(136.,158.,0.));
#414=DIRECTION(' AXIS ',(-1.,0.,0.));
#415=DIRECTION(' REF_DIRECTION',(0.,-1.,0.));
#417=TOLERANCED_PLANE('POSITION TOLERANCED PLANE ON BOSS2',#418,37.,41.,
());
#418=AXIS2_PLACEMENT_3D('POSITION TOLERANCED PLANE ON BOSS2',#419,#420,
#421);
#419=CARTESIAN_POINT('POSITION TOLERANCED PLANE ON BOSS2: LOCATION ',
(166.,158.,0.));
#420=DIRECTION(' AXIS ',(1.,0.,0.));
#421=DIRECTION(' REF_DIRECTION',(0.,-1.,0.));
#422=POSITION_TOLERANCE('POSITION TOLERANCE ON BOSS',(#423,#429),#121,$,
$, $, $, 0.2,$, (), $);
#423=TOLERANCED_PLANE('POSITION TOLERANCED PLANE ON BOSS3',#424,30.,41.,
());
#424=AXIS2_PLACEMENT_3D('POSITION TOLERANCED PLANE ON BOSS3',#425,#426,
#427);
#425=CARTESIAN_POINT('POSITION TOLERANCED PLANE ON BOSS3: LOCATION ',
(136.,195.,0.));
#426=DIRECTION(' AXIS ',(0.,1.,0.));
#427=DIRECTION(' REF_DIRECTION',(-1.,0.,0.));
#429=TOLERANCED_PLANE('POSITION TOLERANCED PLANE ON BOSS4',#430,30.,41.,
());
#430=AXIS2_PLACEMENT_3D('POSITION TOLERANCED PLANE ON BOSS4',#431,#432,
#433);
#431=CARTESIAN_POINT('POSITION TOLERANCED PLANE ON BOSS4: LOCATION ',
(136.,158.,0.));
#432=DIRECTION(' AXIS ',(0.,1.,0.));
#433=DIRECTION(' REF_DIRECTION',(0.,0.,-1.));

```

```
#122=BOTTOM_AND_SIDE_ROUGH_MILLING($,$,'ROUGHING POCKET',15.,$, #124, #138,
    #133, #207, #208, $, #140, 9., 9., 1., 0.5);
#124=MILLING_CUTTING_TOOL('MILL 18MM', #137, (#131), 80., $, $);
#128=MILLING_TOOL_DIMENSION(18., $, $, 29., 0., $, $);
#131=CUTTING_COMPONENT(50., $, $, $, $);
#133=MILLING_MACHINE_FUNCTIONS(.T., $, $, .F., $, (), .T., $, $, ());
#135=DRILLING_TYPE_STRATEGY($, $, $, $, $, $);
#137=TAPERED_ENDMILL(#128, 4, .RIGHT., .F., $, $);
#138=MILLING_TECHNOLOGY(0.04, .TCP., $, -20., $, .F., .F., .F., $);
#140=CONTOUR_PARALLEL($, $, .CW., .CONVENTIONAL.);
#141=PLANAR_POCKET_BOTTOM_CONDITION();
#142=TOLERANCED_LENGTH_MEASURE(10., #155);
#147=TOLERANCED_LENGTH_MEASURE(64., #160);
#148=TOLERANCED_LENGTH_MEASURE(87., #161);
#149=TOLERANCED_LENGTH_MEASURE(80., #162);
#150=TOLERANCED_LENGTH_MEASURE(87., #163);
#152=TOLERANCED_LENGTH_MEASURE(9., #165);
#153=TOLERANCED_LENGTH_MEASURE(10., #166);
#154=TOLERANCED_LENGTH_MEASURE(20., #167);
#155=PLUS_MINUS_VALUE(0.1, 0.1, 3);
#156=PLUS_MINUS_VALUE(0.1, 0.1, 3);
#157=PLUS_MINUS_VALUE(0.1, 0.1, 3);
#158=PLUS_MINUS_VALUE(0.1, 0.1, 3);
#159=PLUS_MINUS_VALUE(0.1, 0.1, 3);
#160=PLUS_MINUS_VALUE(0.1, 0.1, 3);
#161=PLUS_MINUS_VALUE(0.1, 0.1, 3);
#162=PLUS_MINUS_VALUE(0.1, 0.1, 3);
#163=PLUS_MINUS_VALUE(0.1, 0.1, 3);
#165=PLUS_MINUS_VALUE(0.1, 0.1, 3);
#166=PLUS_MINUS_VALUE(0.1, 0.1, 3);
#167=PLUS_MINUS_VALUE(0.1, 0.1, 3);
#170=RECTANGULAR_CLOSED_PROFILE($, #147, #148);
#171=RECTANGULAR_CLOSED_PROFILE($, #149, #150);
#176=TOUCH_TRIGGER_PROBE('PROBE NUM01', $, #179, #178, (#177));
#177=STYLUS_DIMENSION($, 50., 6., 6., $, $);
#178=BODY_DIMENSION(0., 0.);
#179=FIXTURE_DIMENSION(50., 40.);
#200=MACHINING_WORKINGSTEP('STEP ROUGHING', #99, #201, #930, $);
#201=STEP('STEP FEATURE', #108, (#930, #965), #211, (#260), #215, #220, $, ());
#260=PARALLELISM_TOLERANCE('PARALLELISM TOLERANCE ON STEP', (#261), #201,
    $, $, $, $, 0.02, $, (#330), $);
#330=DATUM_REFERENCE(1., #350);
#350=DATUM_DEFINED_BY_FEATURE('DATUM PLANE A', $, 'BLOCK PLANE A');
#261=TOLERANCED_PLANE('PARALLELISM TOLERANCED PLANE', #262, 86., 218., ());
#262=AXIS2_PLACEMENT_3D('PARALLELISM TOLERANCE ON STEP', #263, #264, #265);
#263=CARTESIAN_POINT('PARALLELISM TOLERANCED PLANE: LOCATION ', (0., 240.,
    -30.));
#264=DIRECTION(' AXIS ', (0., 0., 1.));
#265=DIRECTION(' REF_DIRECTION', (1., 0., 0.));
#207=PLUNGE_TOOLAXIS($);
#208=PLUNGE_TOOLAXIS($);
#211=AXIS2_PLACEMENT_3D('STEP', #212, #213, #214);
#212=CARTESIAN_POINT('STEP: LOCATION ', (0., 240., 0.));
#213=DIRECTION(' AXIS ', (0., 0., 1.));
#214=DIRECTION(' REF_DIRECTION', (1., 0., 0.));
#215=PLANE('DEPTH SURFACE FOR STEP', #216);
#216=AXIS2_PLACEMENT_3D('STEP', #217, #218, #219);
#217=CARTESIAN_POINT('STEP: DEPTH ', (0., 240., -30.));
```

```

#218=DIRECTION(' AXIS ', (0.,0.,1.));
#219=DIRECTION(' REF_DIRECTION', (1.,0.,0.));
#220=LINEAR_PATH($, #221, #223);
#221=TOLERANCED_LENGTH_MEASURE(215., #222);
#222=PLUS_MINUS_VALUE(0.3,0.3,3);
#223=DIRECTION('STEP COURSE OF TRAVEL DIRECTION', (1.,0.,0.));
#400=MACHINING_WORKINGSTEP('SLOT ROUGH MILLING', #99, #301, #401, $);
#301=SLOT('SLOT', #108, (#401, #968), #309, (#328), #313, #318, #324, (#327, #327))
;
#309=AXIS2_PLACEMENT_3D('SLOT:LOCATION', #310, #311, #312);
#310=CARTESIAN_POINT('SLOT:LOCATION', (59.,273.,-30.));
#311=DIRECTION(' AXIS ', (0.,0.,1.));
#312=DIRECTION(' REF_DIRECTION ', (1.,0.,0.));
#313=PLANE('DEPTH SURFACE FOR SLOT', #314);
#314=AXIS2_PLACEMENT_3D('SLOT', #315, #316, #317);
#315=CARTESIAN_POINT('SLOT: DEPTH ', (60.,270.,-20.));
#316=DIRECTION(' AXIS ', (0.,0.,1.));
#317=DIRECTION(' REF_DIRECTION', (1.,0.,0.));
#318=LINEAR_PATH($, #319, #320);
#319=TOLERANCED_LENGTH_MEASURE(100., #326);
#320=DIRECTION('SLOT COURSE OF TRAVEL DIRECTION', (1.,0.,0.));
#324=SQUARE_U_PROFILE($, #325, #321, 0., #321, 0.);
#325=TOLERANCED_LENGTH_MEASURE(20., #326);
#326=PLUS_MINUS_VALUE(0.3,0.3,3);
#321=TOLERANCED_LENGTH_MEASURE(0.1, #326);
#327=RADIUSED_SLOT_END_TYPE();
#328=PERPENDICULARITY_TOLERANCE('PERPENDICULARITY TOLERANCE ON SLOT',
    (#329, #336), #301, $, $, $, $, 0.02, $, (#330), $);
#329=TOLERANCED_PLANE('PERPENDICULARITY TOLERANCED
    PLANE', #331, 100., 20., ());
#331=AXIS2_PLACEMENT_3D('PERPENDICULARITY ON SLOT', #332, #333, #334);
#332=CARTESIAN_POINT('PERPENDICULARITY TOLERANCED PLANE1: LOCATION ',
    (59.,293.,-30.));
#333=DIRECTION(' AXIS ', (0.,1.,0.));
#334=DIRECTION(' REF_DIRECTION', (-1.,0.,0.));
#336=TOLERANCED_PLANE('PERPENDICULARITY TOLERANCED PLANE', #337, 100.,
    20., ());
#337=AXIS2_PLACEMENT_3D('PERPENDICULARITY ON SLOT', #338, #339, #340);
#338=CARTESIAN_POINT('PERPENDICULARITY TOLERANCED PLANE2: LOCATION ',
    (59.,273.,-30.));
#339=DIRECTION(' AXIS ', (0.,1.,0.));
#340=DIRECTION(' REF_DIRECTION', (0.,0.,-1.));
#401=BOTTOM_AND_SIDE_ROUGH_MILLING($, $, 'SLOT ROUGHING', 15., $, #124, #138,
    #133, #207, #208, $, #406, 6.5, 5., 1., 0.5);
#406=UNIDIRECTIONAL_MILLING($, .T., #407, $);
#407=DIRECTION('STRATEGY SLOT: 1.DIRECTION', (1.,0.,0.));;
#500=BOSS('POCKET-BOSS', #108, (), #504, (), #508, #501, $);
#501=RECTANGULAR_CLOSED_PROFILE($, #502, #503);
#502=TOLERANCED_LENGTH_MEASURE(30., #326);
#503=TOLERANCED_LENGTH_MEASURE(37., #326);
#504=AXIS2_PLACEMENT_3D('BOSS', #505, #506, #507);
#505=CARTESIAN_POINT('BOSS: LOCATION ', (136.,158.,-41.));
#506=DIRECTION(' AXIS ', (0.,0.,1.));
#507=DIRECTION(' REF_DIRECTION', (1.,0.,0.));
#508=PLANE('DEPTH SURFACE FOR BOSS', #509);
#509=AXIS2_PLACEMENT_3D('BOSS', #510, #511, #512);
#510=CARTESIAN_POINT('BOSS: DEPTH ', (136.,168.,-41.));
#511=DIRECTION(' AXIS ', (0.,0.,1.));

```

```

#512=DIRECTION(' REF_DIRECTION', (1.,0.,0.));
#600=MACHINING_WORKINGSTEP('HOLE DRILLING', #99, #601, #602, $);
#601=ROUND_HOLE('HOLE1', #108, (#602), #603, (#620), #607, #610, $, #612);
#620=POSITION_TOLERANCE('POSITION TOLERANCE ON HOLE1', (#621), #601, $, $,
    $, $, 0.05, $, (#622), $);
#621=TOLERANCED_CYLINDER('POSITION TOLERANCED CYLINDER HOLE1', #603, #607,
    16.);
#622=DATUM_REFERENCE(3., #623);
#623=DATUM_DEFINED_BY_FEATURE('DATUM PLANE A,B,C', $, 'BLOCK PLANE A,B,C');
#602=DRILLING($, $, 'DRILL HOLE1', 10., $, #613, #617, #618, $, $, $, $, #619);
#603=AXIS2_PLACEMENT_3D('HOLE1', #604, #605, #606);
#604=CARTESIAN_POINT('HOLE1: LOCATION ', (25., 308., -30.));
#605=DIRECTION(' AXIS ', (0., 0., 1.));
#606=DIRECTION(' REF_DIRECTION', (1., 0., 0.));
#607=PLANE('DEPTH SURFACE FOR ROUND HOLE1', #608);
#608=AXIS2_PLACEMENT_3D('HOLE1', #609, #605, #606);
#609=CARTESIAN_POINT('HOLE1: DEPTH ', (25., 308., -60.));
#610=TOLERANCED_LENGTH_MEASURE(16., #611);
#611=PLUS_MINUS_VALUE(0.1, 0.1, 3);
#612=THROUGH_BOTTOM_CONDITION();
#613=MILLING_CUTTING_TOOL('SPIRAL_DRILL_16MM', #614, (#615), 90., $, $);
#614=TWIST_DRILL(#616, 2, .RIGHT., .F., 0.84);
#615=CUTTING_COMPONENT(45., $, $, $, $);
#616=MILLING_TOOL_DIMENSION(16., 31., 0.1, 70., 2., 5., 8.);
#617=MILLING_TECHNOLOGY(0.03, .TCP., $, -16., $, .F., .F., .F., $);
#618=MILLING_MACHINE_FUNCTIONS(.T., $, $, .F., $, (), .T., $, $, ());
#619=DRILLING_TYPE_STRATEGY(0.75, 0.5, 2., 0.5, 0.75, 8.);
#700=MACHINING_WORKINGSTEP('HOLE DRILLING', #99, #701, #702, $);
#701=ROUND_HOLE('HOLE1', #108, (#702), #703, (#710), #707, #610, $, #612);
#710=POSITION_TOLERANCE('POSITION TOLERANCE ON HOLE2', (#711), #701, $, $,
    $, $, 0.05, $, (#622), $);
#711=TOLERANCED_CYLINDER('POSITION TOLERANCED CYLINDER HOLE2', #703, #707,
    16.);
#702=DRILLING($, $, 'DRILL HOLE2', 10., $, #613, #617, #618, $, $, $, $, #619);
#703=AXIS2_PLACEMENT_3D('HOLE2', #704, #705, #706);
#704=CARTESIAN_POINT('HOLE2: LOCATION ', (193., 308., -30.));
#705=DIRECTION(' AXIS ', (0., 0., 1.));
#706=DIRECTION(' REF_DIRECTION', (1., 0., 0.));
#707=PLANE('DEPTH SURFACE FOR ROUND HOLE2', #708);
#708=AXIS2_PLACEMENT_3D('HOLE2', #709, #705, #706);
#709=CARTESIAN_POINT('HOLE2: DEPTH ', (193., 308., -60.));
#800=MACHINING_WORKINGSTEP('HOLE DRILLING', #99, #801, #802, $);
#801=ROUND_HOLE('HOLE3', #108, (#802), #803, (#810), #807, #610, $, #612);
#810=POSITION_TOLERANCE('POSITION TOLERANCE ON HOLE3', (#811), #801, $, $,
    $, $, 0.05, $, (#622), $);
#811=TOLERANCED_CYLINDER('POSITION TOLERANCED CYLINDER HOLE3', #803, #807,
    16.);
#802=DRILLING($, $, 'DRILL HOLE3', 10., $, #613, #617, #618, $, $, $, $, #619);
#803=AXIS2_PLACEMENT_3D('HOLE3', #804, #805, #806);
#804=CARTESIAN_POINT('HOLE3: LOCATION ', (25., 258., -30.));
#805=DIRECTION(' AXIS ', (0., 0., 1.));
#806=DIRECTION(' REF_DIRECTION', (1., 0., 0.));
#807=PLANE('DEPTH SURFACE FOR ROUND HOLE3', #808);
#808=AXIS2_PLACEMENT_3D('HOLE3', #809, #805, #806);
#809=CARTESIAN_POINT('HOLE3: DEPTH ', (25., 258., -60.));
#900=MACHINING_WORKINGSTEP('HOLE DRILLING', #99, #901, #902, $);
#901=ROUND_HOLE('HOLE3', #108, (#902), #903, (#910), #907, #610, $, #612);
#910=POSITION_TOLERANCE('POSITION TOLERANCE ON HOLE4', (#911), #901, $, $,

```

```

$, $, 0.05, $, (#622), $);
#911=TOLERANCED_CYLINDER('POSITION TOLERANCED CYLINDER HOLE4', #903, #907,
16.);
#902=DRILLING($, $, 'DRILL HOLE4', 10., $, #613, #617, #618, $, $, $, $, #619);
#903=AXIS2_PLACEMENT_3D('HOLE4', #904, #905, #906);
#904=CARTESIAN_POINT('HOLE4: LOCATION ', (193., 258., -30.));
#905=DIRECTION(' AXIS ', (0., 0., 1.));
#906=DIRECTION(' REF_DIRECTION', (1., 0., 0.));
#907=PLANE('DEPTH SURFACE FOR ROUND HOLE4', #908);
#908=AXIS2_PLACEMENT_3D('HOLE4', #909, #905, #906);
#909=CARTESIAN_POINT('HOLE4: DEPTH ', (193., 258., -60.));
#920=BOTTOM_AND_SIDE_ROUGH_MILLING($, $, 'ROUGH DIAGONAL POCKET', 15., $,
#921, #138, #133, #207, #208, $, #140, 6.5, 5., 1., 0.5);
#921=MILLING_CUTTING_TOOL('MILL 40MM', #922, (#924), 80., $, $);
#922=TAPERED_ENDMILL(#923, 4, .RIGHT., .F., $, $);
#923=MILLING_TOOL_DIMENSION(40., $, $, 29., 0., $, $);
#924=CUTTING_COMPONENT(60., $, $, $, $);
#930=BOTTOM_AND_SIDE_ROUGH_MILLING($, $, 'ROUGH STEP', 15., $, #921, #931,
#932, #207, #208, $, #933, 6.5, 5., 1., 0.5);
#931=MILLING_TECHNOLOGY(0.04, .TCP., $, -12., $, .F., .F., .F., $);
#932=MILLING_MACHINE_FUNCTIONS(.T., $, $, .F., $, (), .T., $, $, ());
#933=BIDIRECTIONAL_MILLING(0.05, .T., #934, .LEFT., $);
#934=DIRECTION('STRATEGY STEP: 1.DIRECTION', (0., 1., 0.));
#955=MACHINING_WORKINGSTEP('TOP SURFACE FINISH MILLING', #99, #940, #941, $);
#940=PLANAR_FACE('TOP SURFACE', #108, (#941), #942, (), #946, #949, #950, $, ());
#941=PLANE_FINISH_MILLING($, $, 'FINISH TOP SURFACE', 10., $, #921, #138, #133,
$, #207, #208, #933, 2.5, $);
#942=AXIS2_PLACEMENT_3D('TOP SURFACE', #943, #944, #945);
#943=CARTESIAN_POINT('TOP SURFACE:LOCATION ', (0., 0., 5.));
#944=DIRECTION(' AXIS ', (0., 0., 1.));
#945=DIRECTION(' REF_DIRECTION', (1., 0., 0.));
#946=PLANE('TOP SURFACE-DEPTH PLANE', #947);
#947=AXIS2_PLACEMENT_3D('TOP SURFACE', #948, #944, #945);
#948=CARTESIAN_POINT('TOP SURFACE:DEPTH ', (0., 0., -5.));
#949=LINEAR_PATH($, #951, #952);
#950=LINEAR_PROFILE($, #953);
#951=TOLERANCED_LENGTH_MEASURE(326., #954);
#952=DIRECTION('COURSE OF TRAVEL DIRECTION', (0., 1., 0.));
#953=NUMERIC_PARAMETER('PROFILE LENGTH', 218., 'MM');
#954=PLUS_MINUS_VALUE(0.3, 0.3, 3);
ENDSEC;
END-ISO-10303-21;

```



# *Appendix C STEP-INSPEC*

## *Software Output Files*

The following three output files are generated by the STEP-INSPEC software prototype. The listed outputs are from processing the second case study – Fish-head roughing example. The listed output was generated when setup inspection was chosen by the operator but finish inspection was not chosen.

Appendix C.1 contains the CMC output of the case study. Appendix C.2 shows the G-code output of the case study; and the new STEP Part 21 file with measurement operations inserted is displayed in Appendix C.3.

## Appendix C.1 CMC Output of Fish-head Roughing Example

```

1 USE_LENGTH_UNITS(CANON_UNITS MM)
2 SET_ORIGIN OFFSETS(0.0000, 0.0000, 0.0000)
3 SET_FEED_REFERENCE(CANON_XYZ)
4 STOP_SPINDLE_TURNING()
5 SPINDLE_RETRACT()
6 USE_TOOL_LENGTH_OFFSET(0.0000)
7 CHANGE_TOOL(PROBE_NUM01)
8 USE_TOOL_LENGTH_OFFSET(50.0000)
9 TURN_PROBE_ON()
10 SET_FEED_RATE(230.0000)
11 STRAIGHT_PROBE(104.3064, 64.7463, 5.0000)
12 STRAIGHT_PROBE(66.0859, 111.0328, 5.0000)
13 STRAIGHT_PROBE(56.6123, 18.4300, 5.0000)
14 STRAIGHT_PROBE(98.9276, 277.3756, 5.0000)
15 STRAIGHT_PROBE(86.4669, 0.0000, -20.3494)
16 STRAIGHT_PROBE(77.8548, 0.0000, -4.1473)
17 STRAIGHT_PROBE(104.1967, 0.0000, -20.3632)
18 STRAIGHT_PROBE(125.1431, 0.0000, -24.8978)
19 STRAIGHT_PROBE(218.0000, 30.8610, -11.9907)
20 STRAIGHT_PROBE(218.0000, 121.8123, -20.1050)
21 STRAIGHT_PROBE(218.0000, 130.1990, -25.1440)
22 STRAIGHT_PROBE(218.0000, 259.9056, -22.5677)
23 STRAIGHT_PROBE(63.8073, 326.0000, -3.6319)
24 STRAIGHT_PROBE(85.0598, 326.0000, -6.0635)
25 STRAIGHT_PROBE(69.9346, 326.0000, -29.9258)
26 STRAIGHT_PROBE(113.4607, 326.0000, -20.2377)
27 STRAIGHT_PROBE(0.0000, 159.9756, -25.2731)
28 STRAIGHT_PROBE(0.0000, 132.5917, -22.0212)
29 STRAIGHT_PROBE(0.0000, 78.9680, -4.7067)
30 STRAIGHT_PROBE(0.0000, 242.4307, -17.9077)
31 TURN_PROBE_OFF()
32 SPINDLE_RETRACT()
33 SPINDLE_RETRACT()
34 USE_TOOL_LENGTH_OFFSET(0.0000)
35 CHANGE_TOOL(MILL_40MM)
36 USE_TOOL_LENGTH_OFFSET(60.0000)
37 FLOOD_ON()
38 SET_SPINDLE_SPEED(1200.0000)
39 START_SPINDLE_CLOCKWISE()
40 SET_FEED_RATE(2400.0000)
41 STRAIGHT_TRAVERSE(200.0000, -30.0000, 200.0000)
42 STRAIGHT_TRAVERSE(200.0000, -30.0000, 15.0000)
43 STRAIGHT_FEED(200.0000, -30.0000, 2.5000)
44 STRAIGHT_FEED(200.0000, 356.0000, 2.5000)
45 STRAIGHT_FEED(162.0000, 356.0000, 2.5000)
46 STRAIGHT_FEED(162.0000, -30.0000, 2.5000)
47 STRAIGHT_FEED(124.0000, -30.0000, 2.5000)
48 STRAIGHT_FEED(124.0000, 356.0000, 2.5000)
49 STRAIGHT_FEED(86.0000, 356.0000, 2.5000)
50 STRAIGHT_FEED(86.0000, -30.0000, 2.5000)
51 STRAIGHT_FEED(48.0000, -30.0000, 2.5000)
52 STRAIGHT_FEED(48.0000, 356.0000, 2.5000)
53 STRAIGHT_FEED(10.0000, 356.0000, 2.5000)
54 STRAIGHT_FEED(10.0000, -30.0000, 2.5000)
55 STRAIGHT_TRAVERSE(10.0000, -30.0000, 15.0000)
56 STRAIGHT_TRAVERSE(200.0000, -30.0000, 15.0000)
57 STRAIGHT_FEED(200.0000, -30.0000, 0.0000)
58 STRAIGHT_FEED(200.0000, 356.0000, 0.0000)
59 STRAIGHT_FEED(162.0000, 356.0000, 0.0000)
60 STRAIGHT_FEED(162.0000, -30.0000, 0.0000)
61 STRAIGHT_FEED(124.0000, -30.0000, 0.0000)
62 STRAIGHT_FEED(124.0000, 356.0000, 0.0000)
63 STRAIGHT_FEED(86.0000, 356.0000, 0.0000)
64 STRAIGHT_FEED(86.0000, -30.0000, 0.0000)
65 STRAIGHT_FEED(48.0000, -30.0000, 0.0000)
66 STRAIGHT_FEED(48.0000, 356.0000, 0.0000)
67 STRAIGHT_FEED(10.0000, 356.0000, 0.0000)
68 STRAIGHT_FEED(10.0000, -30.0000, 0.0000)
69 STRAIGHT_TRAVERSE(10.0000, -30.0000, 15.0000)
70 STOP_SPINDLE_TURNING()
71 FLOOD_OFF()
72 SPINDLE_RETRACT()
73 USE_TOOL_LENGTH_OFFSET(0.0000)
74 CHANGE_TOOL(MILL_18MM)
75 USE_TOOL_LENGTH_OFFSET(50.0000)
76 FLOOD_ON()
77 START_SPINDLE_CLOCKWISE()
78 STRAIGHT_TRAVERSE(10.0000, -30.0000, 30.0000)
79 STRAIGHT_TRAVERSE(55.5000, 176.5000, 30.0000)
80 STRAIGHT_TRAVERSE(55.5000, 176.5000, 15.0000)
81 STRAIGHT_FEED(55.5000, 176.5000, -8.1000)
82 STRAIGHT_FEED(78.5000, 176.5000, -8.1000)
83 STRAIGHT_FEED(85.8333, 176.5000, -8.1000)
84 STRAIGHT_FEED(85.8333, 169.1667, -8.1000)
85 STRAIGHT_FEED(48.1667, 169.1667, -8.1000)
86 STRAIGHT_FEED(48.1667, 183.8333, -8.1000)
87 STRAIGHT_FEED(85.8333, 183.8333, -8.1000)
88 STRAIGHT_FEED(85.8333, 176.5000, -8.1000)
89 STRAIGHT_FEED(93.1667, 176.5000, -8.1000)
90 STRAIGHT_FEED(93.1667, 161.8333, -8.1000)
91 STRAIGHT_FEED(40.8333, 161.8333, -8.1000)
92 STRAIGHT_FEED(40.8333, 191.1667, -8.1000)
93 STRAIGHT_FEED(93.1667, 191.1667, -8.1000)
94 STRAIGHT_FEED(93.1667, 176.5000, -8.1000)
95 STRAIGHT_FEED(100.5000, 176.5000, -8.1000)
96 STRAIGHT_FEED(100.5000, 154.5000, -8.1000)
97 STRAIGHT_FEED(33.5000, 154.5000, -8.1000)
98 STRAIGHT_FEED(33.5000, 198.5000, -8.1000)
99 STRAIGHT_FEED(100.5000, 198.5000, -8.1000)
100 STRAIGHT_FEED(100.5000, 176.5000, -8.1000)
101 STRAIGHT_FEED(100.5000, 176.5000, 0.0000)
102 STRAIGHT_TRAVERSE(55.5000, 176.5000, 0.0000)
103 STRAIGHT_FEED(55.5000, 176.5000, -8.1000)
104 STRAIGHT_FEED(55.5000, 176.5000, -16.2000)
105 STRAIGHT_FEED(78.5000, 176.5000, -16.2000)
106 STRAIGHT_FEED(85.8333, 176.5000, -16.2000)
107 STRAIGHT_FEED(85.8333, 169.1667, -16.2000)
108 STRAIGHT_FEED(48.1667, 169.1667, -16.2000)
109 STRAIGHT_FEED(48.1667, 183.8333, -16.2000)
110 STRAIGHT_FEED(85.8333, 183.8333, -16.2000)
111 STRAIGHT_FEED(85.8333, 176.5000, -16.2000)
112 STRAIGHT_FEED(93.1667, 176.5000, -16.2000)
113 STRAIGHT_FEED(93.1667, 161.8333, -16.2000)
114 STRAIGHT_FEED(40.8333, 161.8333, -16.2000)
115 STRAIGHT_FEED(40.8333, 191.1667, -16.2000)
116 STRAIGHT_FEED(93.1667, 191.1667, -16.2000)
117 STRAIGHT_FEED(93.1667, 176.5000, -16.2000)
118 STRAIGHT_FEED(100.5000, 176.5000, -16.2000)
119 STRAIGHT_FEED(100.5000, 154.5000, -16.2000)
120 STRAIGHT_FEED(33.5000, 154.5000, -16.2000)
121 STRAIGHT_FEED(33.5000, 198.5000, -16.2000)
122 STRAIGHT_FEED(100.5000, 198.5000, -16.2000)
123 STRAIGHT_FEED(100.5000, 176.5000, -16.2000)
124 STRAIGHT_FEED(100.5000, 176.5000, -8.1000)
125 STRAIGHT_TRAVERSE(55.5000, 176.5000, -8.1000)
126 STRAIGHT_FEED(55.5000, 176.5000, -16.2000)
127 STRAIGHT_FEED(55.5000, 176.5000, -24.3000)
128 STRAIGHT_FEED(78.5000, 176.5000, -24.3000)
129 STRAIGHT_FEED(85.8333, 176.5000, -24.3000)
130 STRAIGHT_FEED(85.8333, 169.1667, -24.3000)
131 STRAIGHT_FEED(48.1667, 169.1667, -24.3000)
132 STRAIGHT_FEED(48.1667, 183.8333, -24.3000)
133 STRAIGHT_FEED(85.8333, 183.8333, -24.3000)
134 STRAIGHT_FEED(85.8333, 176.5000, -24.3000)
135 STRAIGHT_FEED(93.1667, 176.5000, -24.3000)
136 STRAIGHT_FEED(93.1667, 161.8333, -24.3000)
137 STRAIGHT_FEED(40.8333, 161.8333, -24.3000)
138 STRAIGHT_FEED(40.8333, 191.1667, -24.3000)

```

```
139 STRAIGHT_FEED(93.1667, 191.1667, -24.3000)
140 STRAIGHT_FEED(93.1667, 176.5000, -24.3000)
141 STRAIGHT_FEED(100.5000, 176.5000, -24.3000)
142 STRAIGHT_FEED(100.5000, 154.5000, -24.3000)
143 STRAIGHT_FEED(33.5000, 154.5000, -24.3000)
144 STRAIGHT_FEED(33.5000, 198.5000, -24.3000)
145 STRAIGHT_FEED(100.5000, 198.5000, -24.3000)
146 STRAIGHT_FEED(100.5000, 176.5000, -24.3000)
147 STRAIGHT_FEED(100.5000, 176.5000, -16.2000)
148 STRAIGHT_TRAVERSE(55.5000, 176.5000, -16.2000)
149 STRAIGHT_FEED(55.5000, 176.5000, -24.3000)
150 STRAIGHT_FEED(55.5000, 176.5000, -32.4000)
151 STRAIGHT_FEED(78.5000, 176.5000, -32.4000)
152 STRAIGHT_FEED(85.8333, 176.5000, -32.4000)
153 STRAIGHT_FEED(85.8333, 169.1667, -32.4000)
154 STRAIGHT_FEED(48.1667, 169.1667, -32.4000)
155 STRAIGHT_FEED(48.1667, 183.8333, -32.4000)
156 STRAIGHT_FEED(85.8333, 183.8333, -32.4000)
157 STRAIGHT_FEED(85.8333, 176.5000, -32.4000)
158 STRAIGHT_FEED(93.1667, 176.5000, -32.4000)
159 STRAIGHT_FEED(93.1667, 161.8333, -32.4000)
160 STRAIGHT_FEED(40.8333, 161.8333, -32.4000)
161 STRAIGHT_FEED(40.8333, 191.1667, -32.4000)
162 STRAIGHT_FEED(93.1667, 191.1667, -32.4000)
163 STRAIGHT_FEED(93.1667, 176.5000, -32.4000)
164 STRAIGHT_FEED(100.5000, 176.5000, -32.4000)
165 STRAIGHT_FEED(100.5000, 154.5000, -32.4000)
166 STRAIGHT_FEED(33.5000, 154.5000, -32.4000)
167 STRAIGHT_FEED(33.5000, 198.5000, -32.4000)
168 STRAIGHT_FEED(100.5000, 198.5000, -32.4000)
169 STRAIGHT_FEED(100.5000, 176.5000, -32.4000)
170 STRAIGHT_FEED(100.5000, 176.5000, -24.3000)
171 STRAIGHT_TRAVERSE(55.5000, 176.5000, -24.3000)
172 STRAIGHT_FEED(55.5000, 176.5000, -32.4000)
173 STRAIGHT_FEED(55.5000, 176.5000, -40.5000)
174 STRAIGHT_FEED(78.5000, 176.5000, -40.5000)
175 STRAIGHT_FEED(85.8333, 176.5000, -40.5000)
176 STRAIGHT_FEED(85.8333, 169.1667, -40.5000)
177 STRAIGHT_FEED(48.1667, 169.1667, -40.5000)
178 STRAIGHT_FEED(48.1667, 183.8333, -40.5000)
179 STRAIGHT_FEED(85.8333, 183.8333, -40.5000)
180 STRAIGHT_FEED(85.8333, 176.5000, -40.5000)
181 STRAIGHT_FEED(93.1667, 176.5000, -40.5000)
182 STRAIGHT_FEED(93.1667, 161.8333, -40.5000)
183 STRAIGHT_FEED(40.8333, 161.8333, -40.5000)
184 STRAIGHT_FEED(40.8333, 191.1667, -40.5000)
185 STRAIGHT_FEED(93.1667, 191.1667, -40.5000)
186 STRAIGHT_FEED(93.1667, 176.5000, -40.5000)
187 STRAIGHT_FEED(100.5000, 176.5000, -40.5000)
188 STRAIGHT_FEED(100.5000, 154.5000, -40.5000)
189 STRAIGHT_FEED(33.5000, 154.5000, -40.5000)
190 STRAIGHT_FEED(33.5000, 198.5000, -40.5000)
191 STRAIGHT_FEED(100.5000, 198.5000, -40.5000)
192 STRAIGHT_FEED(100.5000, 176.5000, -40.5000)
193 STRAIGHT_FEED(100.5000, 176.5000, 15.0000)
194 STRAIGHT_TRAVERSE(100.5000, 176.5000, 30.0000)
195 STRAIGHT_TRAVERSE(121.0000, 143.0000, 30.0000)
196 STRAIGHT_TRAVERSE(121.0000, 143.0000, 15.0000)
197 STRAIGHT_FEED(121.0000, 143.0000, -8.1000)
198 STRAIGHT_FEED(199.0000, 143.0000, -8.1000)
199 STRAIGHT_FEED(199.0000, 228.0000, -8.1000)
200 STRAIGHT_FEED(121.0000, 228.0000, -8.1000)
201 STRAIGHT_FEED(121.0000, 143.0000, -8.1000)
202 STRAIGHT_FEED(123.5000, 145.5000, -8.1000)
203 STRAIGHT_FEED(196.5000, 145.5000, -8.1000)
204 STRAIGHT_FEED(196.5000, 225.5000, -8.1000)
205 STRAIGHT_FEED(123.5000, 225.5000, -8.1000)
206 STRAIGHT_FEED(123.5000, 145.5000, -8.1000)
207 STRAIGHT_FEED(123.5000, 148.0000, -8.1000)
208 STRAIGHT_TRAVERSE(121.0000, 143.0000, 0.0000)
209 STRAIGHT_FEED(121.0000, 143.0000, -16.2000)
210 STRAIGHT_FEED(199.0000, 143.0000, -16.2000)
211 STRAIGHT_FEED(199.0000, 228.0000, -16.2000)
212 STRAIGHT_FEED(121.0000, 228.0000, -16.2000)
213 STRAIGHT_FEED(121.0000, 143.0000, -16.2000)
214 STRAIGHT_FEED(123.5000, 145.5000, -16.2000)
215 STRAIGHT_FEED(196.5000, 145.5000, -16.2000)
216 STRAIGHT_FEED(196.5000, 225.5000, -16.2000)
217 STRAIGHT_FEED(123.5000, 225.5000, -16.2000)
218 STRAIGHT_FEED(123.5000, 145.5000, -16.2000)
219 STRAIGHT_FEED(123.5000, 148.0000, -16.2000)
220 STRAIGHT_TRAVERSE(121.0000, 143.0000, -8.1000)
221 STRAIGHT_FEED(121.0000, 143.0000, -24.3000)
222 STRAIGHT_FEED(199.0000, 143.0000, -24.3000)
223 STRAIGHT_FEED(199.0000, 228.0000, -24.3000)
224 STRAIGHT_FEED(121.0000, 228.0000, -24.3000)
225 STRAIGHT_FEED(121.0000, 143.0000, -24.3000)
226 STRAIGHT_FEED(123.5000, 145.5000, -24.3000)
227 STRAIGHT_FEED(196.5000, 145.5000, -24.3000)
228 STRAIGHT_FEED(196.5000, 225.5000, -24.3000)
229 STRAIGHT_FEED(123.5000, 225.5000, -24.3000)
230 STRAIGHT_FEED(123.5000, 145.5000, -24.3000)
231 STRAIGHT_FEED(123.5000, 148.0000, -24.3000)
232 STRAIGHT_TRAVERSE(121.0000, 143.0000, -16.2000)
233 STRAIGHT_FEED(121.0000, 143.0000, -32.4000)
234 STRAIGHT_FEED(199.0000, 143.0000, -32.4000)
235 STRAIGHT_FEED(199.0000, 228.0000, -32.4000)
236 STRAIGHT_FEED(121.0000, 228.0000, -32.4000)
237 STRAIGHT_FEED(121.0000, 143.0000, -32.4000)
238 STRAIGHT_FEED(123.5000, 145.5000, -32.4000)
239 STRAIGHT_FEED(196.5000, 145.5000, -32.4000)
240 STRAIGHT_FEED(196.5000, 225.5000, -32.4000)
241 STRAIGHT_FEED(123.5000, 225.5000, -32.4000)
242 STRAIGHT_FEED(123.5000, 145.5000, -32.4000)
243 STRAIGHT_FEED(123.5000, 148.0000, -32.4000)
244 STRAIGHT_TRAVERSE(121.0000, 143.0000, -24.3000)
245 STRAIGHT_FEED(121.0000, 143.0000, -40.5000)
246 STRAIGHT_FEED(199.0000, 143.0000, -40.5000)
247 STRAIGHT_FEED(199.0000, 228.0000, -40.5000)
248 STRAIGHT_FEED(121.0000, 228.0000, -40.5000)
249 STRAIGHT_FEED(121.0000, 143.0000, -40.5000)
250 STRAIGHT_FEED(123.5000, 145.5000, -40.5000)
251 STRAIGHT_FEED(196.5000, 145.5000, -40.5000)
252 STRAIGHT_FEED(196.5000, 225.5000, -40.5000)
253 STRAIGHT_FEED(123.5000, 225.5000, -40.5000)
254 STRAIGHT_FEED(123.5000, 145.5000, -40.5000)
255 STRAIGHT_FEED(123.5000, 148.0000, -40.5000)
256 STRAIGHT_TRAVERSE(121.0000, 143.0000, -32.4000)
257 STOP_SPINDLE_TURNING()
258 FLOOD_OFF()
259 SPINDLE_RETRACT()
260 USE_TOOL_LENGTH_OFFSET(0.0000)
261 CHANGE_TOOL(PROBE_NUM01)
262 USE_TOOL_LENGTH_OFFSET(50.0000)
263 TURN_PROBE_ON()
264 SET_FEED_RATE(230.0000)
265 STRAIGHT_PROBE(136.0000, 175.8869, -12.4579)
266 STRAIGHT_PROBE(136.0000, 161.0275, -27.1933)
267 STRAIGHT_PROBE(136.0000, 161.4919, -4.6233)
268 STRAIGHT_PROBE(136.0000, 165.8301, -10.3811)
269 STRAIGHT_PROBE(136.0000, 170.7289, -30.2042)
270 STRAIGHT_PROBE(136.0000, 180.8766, -3.5535)
271 STRAIGHT_PROBE(136.0000, 185.3037, -37.4032)
272 STRAIGHT_PROBE(136.0000, 185.8612, -10.9604)
273 STRAIGHT_PROBE(136.0000, 188.4114, -27.0259)
274 STRAIGHT_PROBE(136.0000, 182.7129, -22.7892)
275 STRAIGHT_PROBE(166.0000, 166.1358, -14.7431)
276 STRAIGHT_PROBE(166.0000, 159.5740, -28.5003)
277 STRAIGHT_PROBE(166.0000, 165.1551, -2.3385)
278 STRAIGHT_PROBE(166.0000, 170.7662, -11.8210)
279 STRAIGHT_PROBE(166.0000, 173.9004, -29.8614)
280 STRAIGHT_PROBE(166.0000, 182.8724, -2.9737)
281 STRAIGHT_PROBE(166.0000, 184.2629, -14.3385)
282 STRAIGHT_PROBE(166.0000, 194.7090, -11.6912)
283 STRAIGHT_PROBE(166.0000, 188.7140, -30.9179)
284 STRAIGHT_PROBE(166.0000, 182.1528, -19.7423)
```

```

285 TURN_PROBE_OFF()
286 SPINDLE_RETRACT()
287 USE_TOOL_LENGTH_OFFSET(0.0000)
288 CHANGE_TOOL(PROBE_NUM01)
289 USE_TOOL_LENGTH_OFFSET(50.0000)
290 TURN_PROBE_ON()
291 SET_FEED_RATE(230.0000)
292 STRAIGHT_PROBE(136.0000, 175.8869, -12.4579)
293 STRAIGHT_PROBE(136.0000, 161.0275, -27.1933)
294 STRAIGHT_PROBE(136.0000, 161.4919, -4.6233)
295 STRAIGHT_PROBE(136.0000, 165.8301, -10.3811)
296 STRAIGHT_PROBE(136.0000, 170.7289, -30.2042)
297 STRAIGHT_PROBE(136.0000, 180.8766, -3.5535)
298 STRAIGHT_PROBE(136.0000, 185.3037, -37.4032)
299 STRAIGHT_PROBE(136.0000, 185.8612, -10.9604)
300 STRAIGHT_PROBE(136.0000, 188.4114, -27.0259)
301 STRAIGHT_PROBE(136.0000, 182.7129, -22.7892)
302 STRAIGHT_PROBE(136.0000, 166.1358, -14.7431)
303 STRAIGHT_PROBE(166.0000, 159.5740, -28.5003)
304 STRAIGHT_PROBE(166.0000, 165.1551, -2.3385)
305 STRAIGHT_PROBE(166.0000, 170.7662, -11.8210)
306 STRAIGHT_PROBE(166.0000, 173.9004, -29.8614)
307 STRAIGHT_PROBE(166.0000, 182.8724, -2.9737)
308 STRAIGHT_PROBE(166.0000, 184.2629, -34.7732)
309 STRAIGHT_PROBE(166.0000, 194.7090, -11.6912)
310 STRAIGHT_PROBE(166.0000, 188.7140, -30.9179)
311 STRAIGHT_PROBE(166.0000, 182.1528, -19.7423)
312 STRAIGHT_PROBE(149.6990, 195.0000, -11.1842)
313 STRAIGHT_PROBE(136.0975, 195.0000, -29.8071)
314 STRAIGHT_PROBE(137.2719, 195.0000, -0.0536)
315 STRAIGHT_PROBE(142.8447, 195.0000, -10.9049)
316 STRAIGHT_PROBE(143.9637, 195.0000, -29.5188)
317 STRAIGHT_PROBE(161.1484, 195.0000, -26.6100)
318 STRAIGHT_PROBE(166.0000, 195.0000, -12.4216)
319 STRAIGHT_PROBE(157.7847, 195.0000, -2.3938)
320 STRAIGHT_PROBE(156.4506, 195.0000, -40.3431)
321 STRAIGHT_PROBE(155.1293, 195.0000, -16.6955)
322 STRAIGHT_PROBE(161.3938, 158.0000, -29.1760)
323 STRAIGHT_PROBE(151.9029, 158.0000, -1.8143)
324 STRAIGHT_PROBE(154.6754, 158.0000, -21.8486)
325 STRAIGHT_PROBE(155.6069, 158.0000, -37.7130)
326 STRAIGHT_PROBE(161.3938, 158.0000, -30.5020)
327 STRAIGHT_PROBE(165.1115, 158.0000, -13.1521)
328 STRAIGHT_PROBE(140.2423, 158.0000, -5.9688)
329 STRAIGHT_PROBE(142.4188, 158.0000, -31.1141)
330 STRAIGHT_PROBE(143.0926, 158.0000, -15.2669)
331 STRAIGHT_PROBE(145.5471, 158.0000, -10.5473)
332 TURN_PROBE_OFF()
333 SPINDLE_RETRACT()
334 USE_TOOL_LENGTH_OFFSET(0.0000)
335 CHANGE_TOOL(MILL 18MM)
336 USE_TOOL_LENGTH_OFFSET(50.0000)
337 FLOOD_ON()
338 START_SPINDLE_CLOCKWISE()
339 STRAIGHT_TRAVERSE(145.5471, 158.0000, 30.0000)
340 STRAIGHT_TRAVERSE(120.0000, 142.0000, 30.0000)
341 STRAIGHT_TRAVERSE(120.0000, 142.0000, 15.0000)
342 STRAIGHT_FEED(120.0000, 142.0000, -10.2500)
343 STRAIGHT_FEED(200.0000, 142.0000, -10.2500)
344 STRAIGHT_FEED(200.0000, 229.0000, -10.2500)
345 STRAIGHT_FEED(120.0000, 229.0000, -10.2500)
346 STRAIGHT_FEED(120.0000, 142.0000, -10.2500)
347 STRAIGHT_FEED(123.5000, 145.5000, -10.2500)
348 STRAIGHT_FEED(196.5000, 145.5000, -10.2500)
349 STRAIGHT_FEED(196.5000, 225.5000, -10.2500)
350 STRAIGHT_FEED(123.5000, 225.5000, -10.2500)
351 STRAIGHT_FEED(123.5000, 145.5000, -10.2500)
352 STRAIGHT_FEED(123.5000, 149.0000, -10.2500)
353 STRAIGHT_TRAVERSE(120.0000, 142.0000, 0.0000)
354 STRAIGHT_FEED(120.0000, 142.0000, -20.5000)
355 STRAIGHT_FEED(200.0000, 142.0000, -20.5000)
356 STRAIGHT_FEED(200.0000, 229.0000, -20.5000)
357 STRAIGHT_FEED(120.0000, 229.0000, -20.5000)
358 STRAIGHT_FEED(120.0000, 142.0000, -20.5000)
359 STRAIGHT_FEED(123.5000, 145.5000, -20.5000)
360 STRAIGHT_FEED(196.5000, 145.5000, -20.5000)
361 STRAIGHT_FEED(196.5000, 225.5000, -20.5000)
362 STRAIGHT_FEED(123.5000, 225.5000, -20.5000)
363 STRAIGHT_FEED(123.5000, 145.5000, -20.5000)
364 STRAIGHT_FEED(123.5000, 149.0000, -20.5000)
365 STRAIGHT_TRAVERSE(120.0000, 142.0000, -10.2500)
366 STRAIGHT_FEED(120.0000, 142.0000, -30.7500)
367 STRAIGHT_FEED(200.0000, 142.0000, -30.7500)
368 STRAIGHT_FEED(200.0000, 229.0000, -30.7500)
369 STRAIGHT_FEED(120.0000, 229.0000, -30.7500)
370 STRAIGHT_FEED(120.0000, 142.0000, -30.7500)
371 STRAIGHT_FEED(123.5000, 145.5000, -30.7500)
372 STRAIGHT_FEED(196.5000, 145.5000, -30.7500)
373 STRAIGHT_FEED(196.5000, 225.5000, -30.7500)
374 STRAIGHT_FEED(123.5000, 225.5000, -30.7500)
375 STRAIGHT_FEED(123.5000, 145.5000, -30.7500)
376 STRAIGHT_FEED(123.5000, 149.0000, -30.7500)
377 STRAIGHT_TRAVERSE(120.0000, 142.0000, -20.5000)
378 STRAIGHT_FEED(120.0000, 142.0000, -41.0000)
379 STRAIGHT_FEED(200.0000, 142.0000, -41.0000)
380 STRAIGHT_FEED(200.0000, 229.0000, -41.0000)
381 STRAIGHT_FEED(120.0000, 229.0000, -41.0000)
382 STRAIGHT_FEED(120.0000, 142.0000, -41.0000)
383 STRAIGHT_FEED(123.5000, 145.5000, -41.0000)
384 STRAIGHT_FEED(196.5000, 145.5000, -41.0000)
385 STRAIGHT_FEED(196.5000, 225.5000, -41.0000)
386 STRAIGHT_FEED(123.5000, 225.5000, -41.0000)
387 STRAIGHT_FEED(123.5000, 145.5000, -41.0000)
388 STRAIGHT_FEED(123.5000, 149.0000, -41.0000)
389 STRAIGHT_TRAVERSE(120.0000, 142.0000, -30.7500)
390 STRAIGHT_TRAVERSE(120.0000, 142.0000, 30.0000)
391 STRAIGHT_TRAVERSE(48.0000, 0.0000, 30.0000)
392 STRAIGHT_TRAVERSE(48.0000, 0.0000, 15.0000)
393 STRAIGHT_FEED(48.0000, 0.0000, -7.1667)
394 STRAIGHT_FEED(48.0000, 0.0000, -7.1667)
395 STRAIGHT_FEED(48.0000, 0.0000, -7.1667)
396 STRAIGHT_FEED(168.0000, 0.0000, -7.1667)
397 STRAIGHT_FEED(168.0000, 114.0000, -7.1667)
398 STRAIGHT_FEED(48.0000, 114.0000, -7.1667)
399 STRAIGHT_FEED(48.0000, 0.0000, -7.1667)
400 STRAIGHT_FEED(48.0000, 8.5000, -7.1667)
401 STRAIGHT_FEED(56.5000, 8.5000, -7.1667)
402 STRAIGHT_FEED(159.5000, 8.5000, -7.1667)
403 STRAIGHT_FEED(159.5000, 105.5000, -7.1667)
404 STRAIGHT_FEED(56.5000, 105.5000, -7.1667)
405 STRAIGHT_FEED(56.5000, 8.5000, -7.1667)
406 STRAIGHT_FEED(56.5000, 17.0000, -7.1667)
407 STRAIGHT_FEED(65.0000, 17.0000, -7.1667)
408 STRAIGHT_FEED(151.0000, 17.0000, -7.1667)
409 STRAIGHT_FEED(151.0000, 97.0000, -7.1667)
410 STRAIGHT_FEED(65.0000, 97.0000, -7.1667)
411 STRAIGHT_FEED(65.0000, 17.0000, -7.1667)
412 STRAIGHT_FEED(65.0000, 25.5000, -7.1667)
413 STRAIGHT_FEED(73.5000, 25.5000, -7.1667)
414 STRAIGHT_FEED(142.5000, 25.5000, -7.1667)
415 STRAIGHT_FEED(142.5000, 88.5000, -7.1667)
416 STRAIGHT_FEED(73.5000, 88.5000, -7.1667)
417 STRAIGHT_FEED(73.5000, 25.5000, -7.1667)
418 STRAIGHT_FEED(73.5000, 34.0000, -7.1667)
419 STRAIGHT_FEED(82.0000, 34.0000, -7.1667)
420 STRAIGHT_FEED(134.0000, 34.0000, -7.1667)
421 STRAIGHT_FEED(134.0000, 80.0000, -7.1667)
422 STRAIGHT_FEED(82.0000, 80.0000, -7.1667)
423 STRAIGHT_FEED(82.0000, 34.0000, -7.1667)
424 STRAIGHT_FEED(82.0000, 42.5000, -7.1667)
425 STRAIGHT_FEED(90.5000, 42.5000, -7.1667)
426 STRAIGHT_FEED(125.5000, 42.5000, -7.1667)
427 STRAIGHT_FEED(125.5000, 71.5000, -7.1667)
428 STRAIGHT_FEED(90.5000, 71.5000, -7.1667)
429 STRAIGHT_FEED(90.5000, 42.5000, -7.1667)
430 STRAIGHT_FEED(90.5000, 51.0000, -7.1667)

```

```
431 STRAIGHT_TRAVERSE(48.0000, 0.0000, 0.0000)
432 STRAIGHT_FEED(48.0000, 0.0000, -14.3333)
433 STRAIGHT_FEED(48.0000, 0.0000, -14.3333)
434 STRAIGHT_FEED(168.0000, 0.0000, -14.3333)
435 STRAIGHT_FEED(168.0000, 114.0000, -14.3333)
436 STRAIGHT_FEED(48.0000, 114.0000, -14.3333)
437 STRAIGHT_FEED(48.0000, 0.0000, -14.3333)
438 STRAIGHT_FEED(48.0000, 8.5000, -14.3333)
439 STRAIGHT_FEED(56.5000, 8.5000, -14.3333)
440 STRAIGHT_FEED(159.5000, 8.5000, -14.3333)
441 STRAIGHT_FEED(159.5000, 105.5000, -14.3333)
442 STRAIGHT_FEED(56.5000, 105.5000, -14.3333)
443 STRAIGHT_FEED(56.5000, 8.5000, -14.3333)
444 STRAIGHT_FEED(56.5000, 17.0000, -14.3333)
445 STRAIGHT_FEED(65.0000, 17.0000, -14.3333)
446 STRAIGHT_FEED(151.0000, 17.0000, -14.3333)
447 STRAIGHT_FEED(151.0000, 97.0000, -14.3333)
448 STRAIGHT_FEED(65.0000, 97.0000, -14.3333)
449 STRAIGHT_FEED(65.0000, 17.0000, -14.3333)
450 STRAIGHT_FEED(65.0000, 25.5000, -14.3333)
451 STRAIGHT_FEED(73.5000, 25.5000, -14.3333)
452 STRAIGHT_FEED(142.5000, 25.5000, -14.3333)
453 STRAIGHT_FEED(142.5000, 88.5000, -14.3333)
454 STRAIGHT_FEED(73.5000, 88.5000, -14.3333)
455 STRAIGHT_FEED(73.5000, 25.5000, -14.3333)
456 STRAIGHT_FEED(73.5000, 34.0000, -14.3333)
457 STRAIGHT_FEED(82.0000, 34.0000, -14.3333)
458 STRAIGHT_FEED(134.0000, 34.0000, -14.3333)
459 STRAIGHT_FEED(134.0000, 80.0000, -14.3333)
460 STRAIGHT_FEED(82.0000, 80.0000, -14.3333)
461 STRAIGHT_FEED(82.0000, 34.0000, -14.3333)
462 STRAIGHT_FEED(82.0000, 42.5000, -14.3333)
463 STRAIGHT_FEED(90.5000, 42.5000, -14.3333)
464 STRAIGHT_FEED(125.5000, 42.5000, -14.3333)
465 STRAIGHT_FEED(125.5000, 71.5000, -14.3333)
466 STRAIGHT_FEED(90.5000, 71.5000, -14.3333)
467 STRAIGHT_FEED(90.5000, 42.5000, -14.3333)
468 STRAIGHT_FEED(90.5000, 51.0000, -14.3333)
469 STRAIGHT_TRAVERSE(48.0000, 0.0000, -7.1667)
470 STRAIGHT_FEED(48.0000, 0.0000, -21.5000)
471 STRAIGHT_FEED(48.0000, 0.0000, -21.5000)
472 STRAIGHT_FEED(168.0000, 0.0000, -21.5000)
473 STRAIGHT_FEED(168.0000, 114.0000, -21.5000)
474 STRAIGHT_FEED(48.0000, 114.0000, -21.5000)
475 STRAIGHT_FEED(48.0000, 0.0000, -21.5000)
476 STRAIGHT_FEED(48.0000, 8.5000, -21.5000)
477 STRAIGHT_FEED(56.5000, 8.5000, -21.5000)
478 STRAIGHT_FEED(159.5000, 8.5000, -21.5000)
479 STRAIGHT_FEED(159.5000, 105.5000, -21.5000)
480 STRAIGHT_FEED(56.5000, 105.5000, -21.5000)
481 STRAIGHT_FEED(56.5000, 8.5000, -21.5000)
482 STRAIGHT_FEED(56.5000, 17.0000, -21.5000)
483 STRAIGHT_FEED(65.0000, 17.0000, -21.5000)
484 STRAIGHT_FEED(151.0000, 17.0000, -21.5000)
485 STRAIGHT_FEED(151.0000, 97.0000, -21.5000)
486 STRAIGHT_FEED(65.0000, 97.0000, -21.5000)
487 STRAIGHT_FEED(65.0000, 17.0000, -21.5000)
488 STRAIGHT_FEED(65.0000, 25.5000, -21.5000)
489 STRAIGHT_FEED(73.5000, 25.5000, -21.5000)
490 STRAIGHT_FEED(142.5000, 25.5000, -21.5000)
491 STRAIGHT_FEED(142.5000, 88.5000, -21.5000)
492 STRAIGHT_FEED(73.5000, 88.5000, -21.5000)
493 STRAIGHT_FEED(73.5000, 25.5000, -21.5000)
494 STRAIGHT_FEED(73.5000, 34.0000, -21.5000)
495 STRAIGHT_FEED(82.0000, 34.0000, -21.5000)
496 STRAIGHT_FEED(134.0000, 34.0000, -21.5000)
497 STRAIGHT_FEED(134.0000, 80.0000, -21.5000)
498 STRAIGHT_FEED(82.0000, 80.0000, -21.5000)
499 STRAIGHT_FEED(82.0000, 34.0000, -21.5000)
500 STRAIGHT_FEED(82.0000, 42.5000, -21.5000)
501 STRAIGHT_FEED(90.5000, 42.5000, -21.5000)
502 STRAIGHT_FEED(125.5000, 42.5000, -21.5000)
503 STRAIGHT_FEED(125.5000, 71.5000, -21.5000)
504 STRAIGHT_FEED(90.5000, 71.5000, -21.5000)
505 STRAIGHT_FEED(90.5000, 42.5000, -21.5000)
506 STRAIGHT_FEED(90.5000, 51.0000, -21.5000)
507 STRAIGHT_TRAVERSE(48.0000, 0.0000, -14.3333)
508 STOP_SPINDLE_TURNING()
509 FLOOD_OFF()
510 SPINDLE_RETRACT()
511 USE_TOOL_LENGTH_OFFSET(0.0000)
512 CHANGE_TOOL(PROBE_NUM01)
513 USE_TOOL_LENGTH_OFFSET(50.0000)
514 TURN_PROBE_ON()
515 SET_FEED_RATE(230.0000)
516 STRAIGHT_PROBE(48.0000, 50.6801, -15.4714)
517 STRAIGHT_PROBE(48.0000, 67.7484, -0.6624)
518 STRAIGHT_PROBE(48.0000, 70.4556, -10.0888)
519 STRAIGHT_PROBE(48.0000, 72.5504, -18.8249)
520 STRAIGHT_PROBE(48.0000, 99.1379, -14.0553)
521 STRAIGHT_PROBE(48.0000, 111.3033, -7.4492)
522 STRAIGHT_PROBE(48.0000, 27.8893, -1.9768)
523 STRAIGHT_PROBE(48.0000, 20.2623, -17.3966)
524 STRAIGHT_PROBE(48.0000, 28.3831, -6.1324)
525 STRAIGHT_PROBE(48.0000, 49.8615, -5.3178)
526 STRAIGHT_PROBE(170.0000, 33.8074, -4.9760)
527 STRAIGHT_PROBE(170.0000, 0.3425, -8.4730)
528 STRAIGHT_PROBE(170.0000, 10.3750, -0.7509)
529 STRAIGHT_PROBE(170.0000, 15.7045, -13.6978)
530 STRAIGHT_PROBE(170.0000, 31.6232, -15.2876)
531 STRAIGHT_PROBE(170.0000, 100.0866, -16.1438)
532 STRAIGHT_PROBE(170.0000, 110.0421, -7.8411)
533 STRAIGHT_PROBE(170.0000, 74.0054, -0.3513)
534 STRAIGHT_PROBE(170.0000, 69.2883, -21.8136)
535 STRAIGHT_PROBE(170.0000, 68.6998, -12.8538)
536 TURN_PROBE_OFF()
537 SPINDLE_RETRACT()
538 USE_TOOL_LENGTH_OFFSET(0.0000)
539 CHANGE_TOOL(MILL_18MM)
540 USE_TOOL_LENGTH_OFFSET(50.0000)
541 FLOOD_ON()
542 START_SPINDLE_CLOCKWISE()
543 STRAIGHT_TRAVERSE(170.0000, 68.6998, 30.0000)
544 STRAIGHT_TRAVERSE(48.0000, 0.0000, 30.0000)
545 STRAIGHT_TRAVERSE(48.0000, 0.0000, 15.0000)
546 STRAIGHT_FEED(48.0000, 0.0000, -11.0000)
547 STRAIGHT_FEED(48.0000, 0.0000, -11.0000)
548 STRAIGHT_FEED(48.0000, 0.0000, -11.0000)
549 STRAIGHT_FEED(170.0000, 0.0000, -11.0000)
550 STRAIGHT_FEED(170.0000, 116.0000, -11.0000)
551 STRAIGHT_FEED(48.0000, 116.0000, -11.0000)
552 STRAIGHT_FEED(48.0000, 0.0000, -11.0000)
553 STRAIGHT_FEED(48.0000, 13.0000, -11.0000)
554 STRAIGHT_FEED(61.0000, 13.0000, -11.0000)
555 STRAIGHT_FEED(157.0000, 13.0000, -11.0000)
556 STRAIGHT_FEED(157.0000, 103.0000, -11.0000)
557 STRAIGHT_FEED(61.0000, 103.0000, -11.0000)
558 STRAIGHT_FEED(61.0000, 13.0000, -11.0000)
559 STRAIGHT_FEED(61.0000, 26.0000, -11.0000)
560 STRAIGHT_FEED(74.0000, 26.0000, -11.0000)
561 STRAIGHT_FEED(144.0000, 26.0000, -11.0000)
562 STRAIGHT_FEED(144.0000, 90.0000, -11.0000)
563 STRAIGHT_FEED(74.0000, 90.0000, -11.0000)
564 STRAIGHT_FEED(74.0000, 26.0000, -11.0000)
565 STRAIGHT_FEED(74.0000, 39.0000, -11.0000)
566 STRAIGHT_FEED(87.0000, 39.0000, -11.0000)
567 STRAIGHT_FEED(131.0000, 39.0000, -11.0000)
568 STRAIGHT_FEED(131.0000, 77.0000, -11.0000)
569 STRAIGHT_FEED(87.0000, 77.0000, -11.0000)
570 STRAIGHT_FEED(87.0000, 39.0000, -11.0000)
571 STRAIGHT_FEED(87.0000, 52.0000, -11.0000)
572 STRAIGHT_TRAVERSE(48.0000, 0.0000, 0.0000)
573 STRAIGHT_FEED(48.0000, 0.0000, -22.0000)
574 STRAIGHT_FEED(48.0000, 0.0000, -22.0000)
575 STRAIGHT_FEED(170.0000, 0.0000, -22.0000)
576 STRAIGHT_FEED(170.0000, 116.0000, -22.0000)
```

```
577 STRAIGHT_FEED(48.0000, 116.0000, -22.0000)
578 STRAIGHT_FEED(48.0000, 0.0000, -22.0000)
579 STRAIGHT_FEED(48.0000, 13.0000, -22.0000)
580 STRAIGHT_FEED(61.0000, 13.0000, -22.0000)
581 STRAIGHT_FEED(157.0000, 13.0000, -22.0000)
582 STRAIGHT_FEED(157.0000, 103.0000, -22.0000)
583 STRAIGHT_FEED(61.0000, 103.0000, -22.0000)
584 STRAIGHT_FEED(61.0000, 13.0000, -22.0000)
585 STRAIGHT_FEED(61.0000, 26.0000, -22.0000)
586 STRAIGHT_FEED(74.0000, 26.0000, -22.0000)
587 STRAIGHT_FEED(144.0000, 26.0000, -22.0000)
588 STRAIGHT_FEED(144.0000, 90.0000, -22.0000)
589 STRAIGHT_FEED(74.0000, 90.0000, -22.0000)
590 STRAIGHT_FEED(74.0000, 26.0000, -22.0000)
591 STRAIGHT_FEED(74.0000, 39.0000, -22.0000)
592 STRAIGHT_FEED(87.0000, 39.0000, -22.0000)
593 STRAIGHT_FEED(131.0000, 39.0000, -22.0000)
594 STRAIGHT_FEED(131.0000, 77.0000, -22.0000)
595 STRAIGHT_FEED(87.0000, 77.0000, -22.0000)
596 STRAIGHT_FEED(87.0000, 39.0000, -22.0000)
597 STRAIGHT_FEED(87.0000, 52.0000, -22.0000)
598 STRAIGHT_TRAVERSE(48.0000, 0.0000, -11.0000)
599 STOP_SPINDLE_TURNING()
600 FLOOD_OFF()
601 SPINDLE_RETRACT()
602 USE_TOOL_LENGTH_OFFSET(0.0000)
603 CHANGE_TOOL(MILL 40MM)
604 USE_TOOL_LENGTH_OFFSET(60.0000)
605 FLOOD_ON()
606 START_SPINDLE_CLOCKWISE()
607 STRAIGHT_TRAVERSE(48.0000, 0.0000, 8.0000)
608 STRAIGHT_TRAVERSE(79.8532, -5.5127, 8.0000)
609 STRAIGHT_TRAVERSE(79.8532, -5.5127, -7.0000)
610 STRAIGHT_FEED(79.8532, -5.5127, -7.6250)
611 STRAIGHT_FEED(103.3797, 76.0000, -27.6250)
612 STRAIGHT_FEED(121.9816, 76.0000, -27.6250)
613 STRAIGHT_FEED(138.5189, -5.5127, -27.6250)
614 STRAIGHT_FEED(98.0711, -5.5127, -27.6250)
615 STRAIGHT_FEED(107.3720, 32.4363, -27.6250)
616 STRAIGHT_FEED(116.6730, -5.5127, -27.6250)
617 STRAIGHT_TRAVERSE(79.8532, -5.5127, -22.0000)
618 STRAIGHT_FEED(103.3797, 76.0000, -33.2500)
619 STRAIGHT_FEED(121.9816, 76.0000, -33.2500)
620 STRAIGHT_FEED(138.5189, -5.5127, -33.2500)
621 STRAIGHT_FEED(98.0711, -5.5127, -33.2500)
622 STRAIGHT_FEED(107.3720, 32.4363, -33.2500)
623 STRAIGHT_FEED(116.6730, -5.5127, -33.2500)
624 STRAIGHT_TRAVERSE(79.8532, -5.5127, -27.6250)
625 STRAIGHT_FEED(103.3797, 76.0000, -38.8750)
626 STRAIGHT_FEED(121.9816, 76.0000, -38.8750)
627 STRAIGHT_FEED(138.5189, -5.5127, -38.8750)
628 STRAIGHT_FEED(98.0711, -5.5127, -38.8750)
629 STRAIGHT_FEED(107.3720, 32.4363, -38.8750)
630 STRAIGHT_FEED(116.6730, -5.5127, -38.8750)
631 STRAIGHT_TRAVERSE(79.8532, -5.5127, -33.2500)
632 STRAIGHT_FEED(103.3797, 76.0000, -44.5000)
633 STRAIGHT_FEED(121.9816, 76.0000, -44.5000)
634 STRAIGHT_FEED(138.5189, -5.5127, -44.5000)
635 STRAIGHT_FEED(98.0711, -5.5127, -44.5000)
636 STRAIGHT_FEED(107.3720, 32.4363, -44.5000)
637 STRAIGHT_FEED(116.6730, -5.5127, -44.5000)
638 STRAIGHT_TRAVERSE(79.8532, -5.5127, -38.8750)
639 STOP_SPINDLE_TURNING()
640 FLOOD_OFF()
641 SPINDLE_RETRACT()
642 USE_TOOL_LENGTH_OFFSET(0.0000)
643 CHANGE_TOOL(PROBE_NUM01)
644 USE_TOOL_LENGTH_OFFSET(50.0000)
645 TURN_PROBE_ON()
646 SET_FEED_RATE(230.0000)
647 STRAIGHT_PROBE(66.4819, 33.0674, -26.8451)
648 STRAIGHT_PROBE(70.3906, 46.6985, -43.3297)
649 STRAIGHT_PROBE(70.5769, 47.3483, -33.7290)
650 STRAIGHT_PROBE(73.2778, 56.7675, -22.0420)
651 STRAIGHT_PROBE(77.4907, 71.4596, -36.4609)
652 STRAIGHT_PROBE(79.0616, 76.9379, -30.6073)
653 STRAIGHT_PROBE(110.9204, 15.4614, -26.1033)
654 STRAIGHT_PROBE(57.2638, 0.9201, -28.7052)
655 STRAIGHT_PROBE(59.2608, 7.8844, -37.0536)
656 STRAIGHT_PROBE(65.4299, 29.3987, -37.7902)
657 TURN_PROBE_OFF()
658 SPINDLE_RETRACT()
659 USE_TOOL_LENGTH_OFFSET(0.0000)
660 CHANGE_TOOL(MILL 40MM)
661 USE_TOOL_LENGTH_OFFSET(60.0000)
662 FLOOD_ON()
663 START_SPINDLE_CLOCKWISE()
664 STRAIGHT_TRAVERSE(65.4299, 29.3987, 8.0000)
665 STRAIGHT_TRAVERSE(76.2252, -5.5127, 8.0000)
666 STRAIGHT_TRAVERSE(76.2252, -5.5127, -7.0000)
667 STRAIGHT_FEED(76.2252, -5.5127, -23.9167)
668 STRAIGHT_FEED(99.7517, 77.0000, -23.9167)
669 STRAIGHT_FEED(125.6096, 77.0000, -23.9167)
670 STRAIGHT_FEED(145.7748, -5.5127, -23.9167)
671 STRAIGHT_FEED(98.0711, -5.5127, -23.9167)
672 STRAIGHT_FEED(111.0000, 45.0885, -23.9167)
673 STRAIGHT_FEED(123.9289, -5.5127, -23.9167)
674 STRAIGHT_TRAVERSE(76.2252, -5.5127, -22.0000)
675 STRAIGHT_FEED(99.7517, 77.0000, -25.8333)
676 STRAIGHT_FEED(125.6096, 77.0000, -25.8333)
677 STRAIGHT_FEED(145.7748, -5.5127, -25.8333)
678 STRAIGHT_FEED(98.0711, -5.5127, -25.8333)
679 STRAIGHT_FEED(111.0000, 45.0885, -25.8333)
680 STRAIGHT_FEED(123.9289, -5.5127, -25.8333)
681 STRAIGHT_TRAVERSE(76.2252, -5.5127, -23.9167)
682 STRAIGHT_FEED(99.7517, 77.0000, -27.7500)
683 STRAIGHT_FEED(125.6096, 77.0000, -27.7500)
684 STRAIGHT_FEED(145.7748, -5.5127, -27.7500)
685 STRAIGHT_FEED(98.0711, -5.5127, -27.7500)
686 STRAIGHT_FEED(111.0000, 45.0885, -27.7500)
687 STRAIGHT_FEED(123.9289, -5.5127, -27.7500)
688 STRAIGHT_TRAVERSE(76.2252, -5.5127, -25.8333)
689 STRAIGHT_FEED(99.7517, 77.0000, -29.6667)
690 STRAIGHT_FEED(125.6096, 77.0000, -29.6667)
691 STRAIGHT_FEED(145.7748, -5.5127, -29.6667)
692 STRAIGHT_FEED(98.0711, -5.5127, -29.6667)
693 STRAIGHT_FEED(111.0000, 45.0885, -29.6667)
694 STRAIGHT_FEED(123.9289, -5.5127, -29.6667)
695 STRAIGHT_TRAVERSE(76.2252, -5.5127, -27.7500)
696 STRAIGHT_FEED(99.7517, 77.0000, -31.5833)
697 STRAIGHT_FEED(125.6096, 77.0000, -31.5833)
698 STRAIGHT_FEED(145.7748, -5.5127, -31.5833)
699 STRAIGHT_FEED(98.0711, -5.5127, -31.5833)
700 STRAIGHT_FEED(111.0000, 45.0885, -31.5833)
701 STRAIGHT_FEED(123.9289, -5.5127, -31.5833)
702 STRAIGHT_TRAVERSE(76.2252, -5.5127, -29.6667)
703 STRAIGHT_FEED(99.7517, 77.0000, -33.5000)
704 STRAIGHT_FEED(125.6096, 77.0000, -33.5000)
705 STRAIGHT_FEED(145.7748, -5.5127, -33.5000)
706 STRAIGHT_FEED(98.0711, -5.5127, -33.5000)
707 STRAIGHT_FEED(111.0000, 45.0885, -33.5000)
708 STRAIGHT_FEED(123.9289, -5.5127, -33.5000)
709 STRAIGHT_TRAVERSE(76.2252, -5.5127, -31.5833)
710 STRAIGHT_FEED(99.7517, 77.0000, -35.4167)
711 STRAIGHT_FEED(125.6096, 77.0000, -35.4167)
712 STRAIGHT_FEED(145.7748, -5.5127, -35.4167)
713 STRAIGHT_FEED(98.0711, -5.5127, -35.4167)
714 STRAIGHT_FEED(111.0000, 45.0885, -35.4167)
715 STRAIGHT_FEED(123.9289, -5.5127, -35.4167)
716 STRAIGHT_TRAVERSE(76.2252, -5.5127, -33.5000)
717 STRAIGHT_FEED(99.7517, 77.0000, -37.3333)
718 STRAIGHT_FEED(125.6096, 77.0000, -37.3333)
719 STRAIGHT_FEED(145.7748, -5.5127, -37.3333)
720 STRAIGHT_FEED(98.0711, -5.5127, -37.3333)
721 STRAIGHT_FEED(111.0000, 45.0885, -37.3333)
722 STRAIGHT_FEED(123.9289, -5.5127, -37.3333)
```

723 STRAIGHT\_TRAVERSE(76.2252, -5.5127, -35.4167)  
724 STRAIGHT\_FEED(99.7517, 77.0000, -39.2500)  
725 STRAIGHT\_FEED(125.6096, 77.0000, -39.2500)  
726 STRAIGHT\_FEED(145.7748, -5.5127, -39.2500)  
727 STRAIGHT\_FEED(98.0711, -5.5127, -39.2500)  
728 STRAIGHT\_FEED(111.0000, 45.0885, -39.2500)  
729 STRAIGHT\_FEED(123.9289, -5.5127, -39.2500)  
730 STRAIGHT\_TRAVERSE(76.2252, -5.5127, -37.3333)  
731 STRAIGHT\_FEED(99.7517, 77.0000, -41.1667)  
732 STRAIGHT\_FEED(125.6096, 77.0000, -41.1667)  
733 STRAIGHT\_FEED(145.7748, -5.5127, -41.1667)  
734 STRAIGHT\_FEED(98.0711, -5.5127, -41.1667)  
735 STRAIGHT\_FEED(111.0000, 45.0885, -41.1667)  
736 STRAIGHT\_FEED(123.9289, -5.5127, -41.1667)  
737 STRAIGHT\_TRAVERSE(76.2252, -5.5127, -39.2500)  
738 STRAIGHT\_FEED(99.7517, 77.0000, -43.0833)  
739 STRAIGHT\_FEED(125.6096, 77.0000, -43.0833)  
740 STRAIGHT\_FEED(145.7748, -5.5127, -43.0833)  
741 STRAIGHT\_FEED(98.0711, -5.5127, -43.0833)  
742 STRAIGHT\_FEED(111.0000, 45.0885, -43.0833)  
743 STRAIGHT\_FEED(123.9289, -5.5127, -43.0833)  
744 STRAIGHT\_TRAVERSE(76.2252, -5.5127, -41.1667)  
745 STRAIGHT\_FEED(99.7517, 77.0000, -45.0000)  
746 STRAIGHT\_FEED(125.6096, 77.0000, -45.0000)  
747 STRAIGHT\_FEED(145.7748, -5.5127, -45.0000)  
748 STRAIGHT\_FEED(98.0711, -5.5127, -45.0000)  
749 STRAIGHT\_FEED(111.0000, 45.0885, -45.0000)  
750 STRAIGHT\_FEED(123.9289, -5.5127, -45.0000)  
751 STRAIGHT\_TRAVERSE(76.2252, -5.5127, -43.0833)  
752 SET\_SPINDLE\_SPEED(720.0000)  
753 STRAIGHT\_TRAVERSE(76.2252, -5.5127, 30.0000)  
754 STRAIGHT\_TRAVERSE(233.0000, 210.0000, 30.0000)  
755 STRAIGHT\_TRAVERSE(233.0000, 210.0000, 15.0000)  
756 STRAIGHT\_FEED(233.0000, 210.0000, -5.9000)  
757 STRAIGHT\_FEED(233.0000, 356.0000, -5.9000)  
758 STRAIGHT\_FEED(228.0000, 356.0000, -5.9000)  
759 STRAIGHT\_FEED(228.0000, 210.0000, -5.9000)  
760 STRAIGHT\_FEED(223.0000, 210.0000, -5.9000)  
761 STRAIGHT\_FEED(223.0000, 356.0000, -5.9000)  
762 STRAIGHT\_FEED(218.0000, 356.0000, -5.9000)  
763 STRAIGHT\_FEED(218.0000, 210.0000, -5.9000)  
764 STRAIGHT\_FEED(213.0000, 210.0000, -5.9000)  
765 STRAIGHT\_FEED(213.0000, 356.0000, -5.9000)  
766 STRAIGHT\_FEED(208.0000, 356.0000, -5.9000)  
767 STRAIGHT\_FEED(208.0000, 210.0000, -5.9000)  
768 STRAIGHT\_FEED(203.0000, 210.0000, -5.9000)  
769 STRAIGHT\_FEED(203.0000, 356.0000, -5.9000)  
770 STRAIGHT\_FEED(198.0000, 356.0000, -5.9000)  
771 STRAIGHT\_FEED(198.0000, 210.0000, -5.9000)  
772 STRAIGHT\_FEED(193.0000, 210.0000, -5.9000)  
773 STRAIGHT\_FEED(193.0000, 356.0000, -5.9000)  
774 STRAIGHT\_FEED(188.0000, 356.0000, -5.9000)  
775 STRAIGHT\_FEED(188.0000, 210.0000, -5.9000)  
776 STRAIGHT\_FEED(183.0000, 210.0000, -5.9000)  
777 STRAIGHT\_FEED(183.0000, 356.0000, -5.9000)  
778 STRAIGHT\_FEED(178.0000, 356.0000, -5.9000)  
779 STRAIGHT\_FEED(178.0000, 210.0000, -5.9000)  
780 STRAIGHT\_FEED(173.0000, 210.0000, -5.9000)  
781 STRAIGHT\_FEED(173.0000, 356.0000, -5.9000)  
782 STRAIGHT\_FEED(168.0000, 356.0000, -5.9000)  
783 STRAIGHT\_FEED(168.0000, 210.0000, -5.9000)  
784 STRAIGHT\_FEED(163.0000, 210.0000, -5.9000)  
785 STRAIGHT\_FEED(163.0000, 356.0000, -5.9000)  
786 STRAIGHT\_FEED(158.0000, 356.0000, -5.9000)  
787 STRAIGHT\_FEED(158.0000, 210.0000, -5.9000)  
788 STRAIGHT\_FEED(153.0000, 210.0000, -5.9000)  
789 STRAIGHT\_FEED(153.0000, 356.0000, -5.9000)  
790 STRAIGHT\_FEED(148.0000, 356.0000, -5.9000)  
791 STRAIGHT\_FEED(148.0000, 210.0000, -5.9000)  
792 STRAIGHT\_FEED(143.0000, 210.0000, -5.9000)  
793 STRAIGHT\_FEED(143.0000, 356.0000, -5.9000)  
794 STRAIGHT\_FEED(138.0000, 356.0000, -5.9000)  
795 STRAIGHT\_FEED(138.0000, 210.0000, -5.9000)  
796 STRAIGHT\_FEED(133.0000, 210.0000, -5.9000)  
797 STRAIGHT\_FEED(133.0000, 356.0000, -5.9000)  
798 STRAIGHT\_FEED(128.0000, 356.0000, -5.9000)  
799 STRAIGHT\_FEED(128.0000, 210.0000, -5.9000)  
800 STRAIGHT\_FEED(123.0000, 210.0000, -5.9000)  
801 STRAIGHT\_FEED(123.0000, 356.0000, -5.9000)  
802 STRAIGHT\_FEED(118.0000, 356.0000, -5.9000)  
803 STRAIGHT\_FEED(118.0000, 210.0000, -5.9000)  
804 STRAIGHT\_FEED(113.0000, 210.0000, -5.9000)  
805 STRAIGHT\_FEED(113.0000, 356.0000, -5.9000)  
806 STRAIGHT\_FEED(108.0000, 356.0000, -5.9000)  
807 STRAIGHT\_FEED(108.0000, 210.0000, -5.9000)  
808 STRAIGHT\_FEED(103.0000, 210.0000, -5.9000)  
809 STRAIGHT\_FEED(103.0000, 356.0000, -5.9000)  
810 STRAIGHT\_FEED(98.0000, 356.0000, -5.9000)  
811 STRAIGHT\_FEED(98.0000, 210.0000, -5.9000)  
812 STRAIGHT\_FEED(93.0000, 210.0000, -5.9000)  
813 STRAIGHT\_FEED(93.0000, 356.0000, -5.9000)  
814 STRAIGHT\_FEED(88.0000, 356.0000, -5.9000)  
815 STRAIGHT\_FEED(88.0000, 210.0000, -5.9000)  
816 STRAIGHT\_FEED(83.0000, 210.0000, -5.9000)  
817 STRAIGHT\_FEED(83.0000, 356.0000, -5.9000)  
818 STRAIGHT\_FEED(78.0000, 356.0000, -5.9000)  
819 STRAIGHT\_FEED(78.0000, 210.0000, -5.9000)  
820 STRAIGHT\_FEED(73.0000, 210.0000, -5.9000)  
821 STRAIGHT\_FEED(73.0000, 356.0000, -5.9000)  
822 STRAIGHT\_FEED(68.0000, 356.0000, -5.9000)  
823 STRAIGHT\_FEED(68.0000, 210.0000, -5.9000)  
824 STRAIGHT\_FEED(63.0000, 210.0000, -5.9000)  
825 STRAIGHT\_FEED(63.0000, 356.0000, -5.9000)  
826 STRAIGHT\_FEED(58.0000, 356.0000, -5.9000)  
827 STRAIGHT\_FEED(58.0000, 210.0000, -5.9000)  
828 STRAIGHT\_FEED(53.0000, 210.0000, -5.9000)  
829 STRAIGHT\_FEED(53.0000, 356.0000, -5.9000)  
830 STRAIGHT\_FEED(48.0000, 356.0000, -5.9000)  
831 STRAIGHT\_FEED(48.0000, 210.0000, -5.9000)  
832 STRAIGHT\_FEED(43.0000, 210.0000, -5.9000)  
833 STRAIGHT\_FEED(43.0000, 356.0000, -5.9000)  
834 STRAIGHT\_FEED(38.0000, 356.0000, -5.9000)  
835 STRAIGHT\_FEED(38.0000, 210.0000, -5.9000)  
836 STRAIGHT\_FEED(33.0000, 210.0000, -5.9000)  
837 STRAIGHT\_FEED(33.0000, 356.0000, -5.9000)  
838 STRAIGHT\_FEED(28.0000, 356.0000, -5.9000)  
839 STRAIGHT\_FEED(28.0000, 210.0000, -5.9000)  
840 STRAIGHT\_FEED(23.0000, 210.0000, -5.9000)  
841 STRAIGHT\_FEED(23.0000, 356.0000, -5.9000)  
842 STRAIGHT\_FEED(18.0000, 356.0000, -5.9000)  
843 STRAIGHT\_FEED(18.0000, 210.0000, -5.9000)  
844 STRAIGHT\_TRAVERSE(18.0000, 210.0000, 15.0000)  
845 STRAIGHT\_TRAVERSE(233.0000, 210.0000, 15.0000)  
846 STRAIGHT\_FEED(233.0000, 210.0000, -11.8000)  
847 STRAIGHT\_FEED(233.0000, 356.0000, -11.8000)  
848 STRAIGHT\_FEED(228.0000, 356.0000, -11.8000)  
849 STRAIGHT\_FEED(228.0000, 210.0000, -11.8000)  
850 STRAIGHT\_FEED(223.0000, 210.0000, -11.8000)  
851 STRAIGHT\_FEED(223.0000, 356.0000, -11.8000)  
852 STRAIGHT\_FEED(218.0000, 356.0000, -11.8000)  
853 STRAIGHT\_FEED(218.0000, 210.0000, -11.8000)  
854 STRAIGHT\_FEED(213.0000, 210.0000, -11.8000)  
855 STRAIGHT\_FEED(213.0000, 356.0000, -11.8000)  
856 STRAIGHT\_FEED(208.0000, 356.0000, -11.8000)  
857 STRAIGHT\_FEED(208.0000, 210.0000, -11.8000)  
858 STRAIGHT\_FEED(203.0000, 210.0000, -11.8000)  
859 STRAIGHT\_FEED(203.0000, 356.0000, -11.8000)  
860 STRAIGHT\_FEED(198.0000, 356.0000, -11.8000)  
861 STRAIGHT\_FEED(198.0000, 210.0000, -11.8000)  
862 STRAIGHT\_FEED(193.0000, 210.0000, -11.8000)  
863 STRAIGHT\_FEED(193.0000, 356.0000, -11.8000)  
864 STRAIGHT\_FEED(188.0000, 356.0000, -11.8000)  
865 STRAIGHT\_FEED(188.0000, 210.0000, -11.8000)  
866 STRAIGHT\_FEED(183.0000, 210.0000, -11.8000)  
867 STRAIGHT\_FEED(183.0000, 356.0000, -11.8000)  
868 STRAIGHT\_FEED(178.0000, 356.0000, -11.8000)







```
1161 STRAIGHT_FEED(123.0000, 356.0000, -29.5000)
1162 STRAIGHT_FEED(118.0000, 356.0000, -29.5000)
1163 STRAIGHT_FEED(118.0000, 210.0000, -29.5000)
1164 STRAIGHT_FEED(113.0000, 210.0000, -29.5000)
1165 STRAIGHT_FEED(113.0000, 356.0000, -29.5000)
1166 STRAIGHT_FEED(108.0000, 356.0000, -29.5000)
1167 STRAIGHT_FEED(108.0000, 210.0000, -29.5000)
1168 STRAIGHT_FEED(103.0000, 210.0000, -29.5000)
1169 STRAIGHT_FEED(103.0000, 356.0000, -29.5000)
1170 STRAIGHT_FEED(98.0000, 356.0000, -29.5000)
1171 STRAIGHT_FEED(98.0000, 210.0000, -29.5000)
1172 STRAIGHT_FEED(93.0000, 210.0000, -29.5000)
1173 STRAIGHT_FEED(93.0000, 356.0000, -29.5000)
1174 STRAIGHT_FEED(88.0000, 356.0000, -29.5000)
1175 STRAIGHT_FEED(88.0000, 210.0000, -29.5000)
1176 STRAIGHT_FEED(83.0000, 210.0000, -29.5000)
1177 STRAIGHT_FEED(83.0000, 356.0000, -29.5000)
1178 STRAIGHT_FEED(78.0000, 356.0000, -29.5000)
1179 STRAIGHT_FEED(78.0000, 210.0000, -29.5000)
1180 STRAIGHT_FEED(73.0000, 210.0000, -29.5000)
1181 STRAIGHT_FEED(73.0000, 356.0000, -29.5000)
1182 STRAIGHT_FEED(68.0000, 356.0000, -29.5000)
1183 STRAIGHT_FEED(68.0000, 210.0000, -29.5000)
1184 STRAIGHT_FEED(63.0000, 210.0000, -29.5000)
1185 STRAIGHT_FEED(63.0000, 356.0000, -29.5000)
1186 STRAIGHT_FEED(58.0000, 356.0000, -29.5000)
1187 STRAIGHT_FEED(58.0000, 210.0000, -29.5000)
1188 STRAIGHT_FEED(53.0000, 210.0000, -29.5000)
1189 STRAIGHT_FEED(53.0000, 356.0000, -29.5000)
1190 STRAIGHT_FEED(48.0000, 356.0000, -29.5000)
1191 STRAIGHT_FEED(48.0000, 210.0000, -29.5000)
1192 STRAIGHT_FEED(43.0000, 210.0000, -29.5000)
1193 STRAIGHT_FEED(43.0000, 356.0000, -29.5000)
1194 STRAIGHT_FEED(38.0000, 356.0000, -29.5000)
1195 STRAIGHT_FEED(38.0000, 210.0000, -29.5000)
1196 STRAIGHT_FEED(33.0000, 210.0000, -29.5000)
1197 STRAIGHT_FEED(33.0000, 356.0000, -29.5000)
1198 STRAIGHT_FEED(28.0000, 356.0000, -29.5000)
1199 STRAIGHT_FEED(28.0000, 210.0000, -29.5000)
1200 STRAIGHT_FEED(23.0000, 210.0000, -29.5000)
1201 STRAIGHT_FEED(23.0000, 356.0000, -29.5000)
1202 STRAIGHT_FEED(18.0000, 356.0000, -29.5000)
1203 STRAIGHT_FEED(18.0000, 210.0000, -29.5000)
1204 STRAIGHT_TRAVERSE(18.0000, 210.0000, 15.0000)
1205 STOP_SPINDLE_TURNING()
1206 FLOOD_OFF()
1207 SPINDLE_RETRACT()
1208 USE_TOOL_LENGTH_OFFSET(0.0000)
1209 CHANGE_TOOL(PROBE_NUM01)
1210 USE_TOOL_LENGTH_OFFSET(50.0000)
1211 TURN_PROBE_ON()
1212 SET_FEED_RATE(230.0000)
1213 STRAIGHT_PROBE(191.7014, 321.8556, -30.0000)
1214 STRAIGHT_PROBE(151.7019, 323.2479, -30.0000)
1215 STRAIGHT_PROBE(94.0371, 322.0888, -30.0000)
1216 STRAIGHT_PROBE(92.4617, 303.1667, -30.0000)
1217 STRAIGHT_PROBE(107.4991, 308.8459, -30.0000)
1218 STRAIGHT_PROBE(140.9569, 307.8167, -30.0000)
1219 STRAIGHT_PROBE(152.2401, 298.7048, -30.0000)
1220 STRAIGHT_PROBE(48.8737, 254.8075, -30.0000)
1221 STRAIGHT_PROBE(28.7695, 244.7218, -30.0000)
1222 STRAIGHT_PROBE(17.9493, 242.3073, -30.0000)
1223 STRAIGHT_PROBE(8.6799, 255.0936, -30.0000)
1224 STRAIGHT_PROBE(5.0169, 262.3185, -30.0000)
1225 STRAIGHT_PROBE(0.2036, 275.2866, -30.0000)
1226 STRAIGHT_PROBE(9.7344, 289.7785, -30.0000)
1227 STRAIGHT_PROBE(3.8427, 293.9878, -30.0000)
1228 STRAIGHT_PROBE(5.2172, 305.3641, -30.0000)
1229 STRAIGHT_PROBE(0.4903, 325.7907, -30.0000)
1230 STRAIGHT_PROBE(54.1414, 318.5165, -30.0000)
1231 STRAIGHT_PROBE(61.5201, 309.0926, -30.0000)
1232 STRAIGHT_PROBE(59.3566, 295.2069, -30.0000)
1233 STRAIGHT_PROBE(87.7222, 293.1126, -30.0000)
1234 STRAIGHT_PROBE(134.9766, 293.3360, -30.0000)
1235 STRAIGHT_PROBE(146.8952, 272.5387, -30.0000)
1236 STRAIGHT_PROBE(136.3491, 263.0045, -30.0000)
1237 STRAIGHT_PROBE(136.5487, 259.6897, -30.0000)
1238 STRAIGHT_PROBE(107.4785, 272.5308, -30.0000)
1239 STRAIGHT_PROBE(96.4434, 263.2266, -30.0000)
1240 STRAIGHT_PROBE(72.4673, 248.9388, -30.0000)
1241 STRAIGHT_PROBE(52.0830, 271.8212, -30.0000)
1242 STRAIGHT_PROBE(44.1535, 282.2776, -30.0000)
1243 STRAIGHT_PROBE(46.8752, 286.6641, -30.0000)
1244 STRAIGHT_PROBE(97.0282, 258.0675, -30.0000)
1245 STRAIGHT_PROBE(128.8148, 248.5838, -30.0000)
1246 STRAIGHT_PROBE(162.0869, 243.3013, -30.0000)
1247 STRAIGHT_PROBE(181.4340, 254.6008, -30.0000)
1248 STRAIGHT_PROBE(176.9480, 264.5228, -30.0000)
1249 STRAIGHT_PROBE(190.0754, 276.9334, -30.0000)
1250 STRAIGHT_PROBE(189.3210, 290.7417, -30.0000)
1251 STRAIGHT_PROBE(183.5603, 304.3566, -30.0000)
1252 STRAIGHT_PROBE(178.2912, 305.9464, -30.0000)
1253 TURN_PROBE_OFF()
1254 SPINDLE_RETRACT()
1255 USE_TOOL_LENGTH_OFFSET(0.0000)
1256 CHANGE_TOOL(MILL_40MM)
1257 USE_TOOL_LENGTH_OFFSET(60.0000)
1258 FLOOD_ON()
1259 SET_SPINDLE_SPEED(1200.0000)
1260 START_SPINDLE_CLOCKWISE()
1261 STRAIGHT_TRAVERSE(178.2912, 305.9464, 30.0000)
1262 STRAIGHT_TRAVERSE(333.0000, 210.0000, 30.0000)
1263 STRAIGHT_TRAVERSE(333.0000, 210.0000, 15.0000)
1264 STRAIGHT_FEED(333.0000, 210.0000, -10.0000)
1265 STRAIGHT_FEED(333.0000, 488.0000, -10.0000)
1266 STRAIGHT_FEED(320.0000, 488.0000, -10.0000)
1267 STRAIGHT_FEED(320.0000, 210.0000, -10.0000)
1268 STRAIGHT_FEED(307.0000, 210.0000, -10.0000)
1269 STRAIGHT_FEED(307.0000, 488.0000, -10.0000)
1270 STRAIGHT_FEED(294.0000, 488.0000, -10.0000)
1271 STRAIGHT_FEED(294.0000, 210.0000, -10.0000)
1272 STRAIGHT_FEED(281.0000, 210.0000, -10.0000)
1273 STRAIGHT_FEED(281.0000, 488.0000, -10.0000)
1274 STRAIGHT_FEED(268.0000, 488.0000, -10.0000)
1275 STRAIGHT_FEED(268.0000, 210.0000, -10.0000)
1276 STRAIGHT_FEED(255.0000, 210.0000, -10.0000)
1277 STRAIGHT_FEED(255.0000, 488.0000, -10.0000)
1278 STRAIGHT_FEED(242.0000, 488.0000, -10.0000)
1279 STRAIGHT_FEED(242.0000, 210.0000, -10.0000)
1280 STRAIGHT_FEED(229.0000, 210.0000, -10.0000)
1281 STRAIGHT_FEED(229.0000, 488.0000, -10.0000)
1282 STRAIGHT_FEED(216.0000, 488.0000, -10.0000)
1283 STRAIGHT_FEED(216.0000, 210.0000, -10.0000)
1284 STRAIGHT_FEED(203.0000, 210.0000, -10.0000)
1285 STRAIGHT_FEED(203.0000, 488.0000, -10.0000)
1286 STRAIGHT_FEED(190.0000, 488.0000, -10.0000)
1287 STRAIGHT_FEED(190.0000, 210.0000, -10.0000)
1288 STRAIGHT_FEED(177.0000, 210.0000, -10.0000)
1289 STRAIGHT_FEED(177.0000, 488.0000, -10.0000)
1290 STRAIGHT_FEED(164.0000, 488.0000, -10.0000)
1291 STRAIGHT_FEED(164.0000, 210.0000, -10.0000)
1292 STRAIGHT_FEED(151.0000, 210.0000, -10.0000)
1293 STRAIGHT_FEED(151.0000, 488.0000, -10.0000)
1294 STRAIGHT_FEED(138.0000, 488.0000, -10.0000)
1295 STRAIGHT_FEED(138.0000, 210.0000, -10.0000)
1296 STRAIGHT_FEED(125.0000, 210.0000, -10.0000)
1297 STRAIGHT_FEED(125.0000, 488.0000, -10.0000)
1298 STRAIGHT_FEED(112.0000, 488.0000, -10.0000)
1299 STRAIGHT_FEED(112.0000, 210.0000, -10.0000)
1300 STRAIGHT_FEED(99.0000, 210.0000, -10.0000)
1301 STRAIGHT_FEED(99.0000, 488.0000, -10.0000)
1302 STRAIGHT_FEED(86.0000, 488.0000, -10.0000)
1303 STRAIGHT_FEED(86.0000, 210.0000, -10.0000)
1304 STRAIGHT_FEED(73.0000, 210.0000, -10.0000)
1305 STRAIGHT_FEED(73.0000, 488.0000, -10.0000)
1306 STRAIGHT_FEED(60.0000, 488.0000, -10.0000)
```

```
1307 STRAIGHT_FEED(60.0000, 210.0000, -10.0000)
1308 STRAIGHT_FEED(47.0000, 210.0000, -10.0000)
1309 STRAIGHT_FEED(47.0000, 488.0000, -10.0000)
1310 STRAIGHT_FEED(34.0000, 488.0000, -10.0000)
1311 STRAIGHT_FEED(34.0000, 210.0000, -10.0000)
1312 STRAIGHT_FEED(21.0000, 210.0000, -10.0000)
1313 STRAIGHT_FEED(21.0000, 488.0000, -10.0000)
1314 STRAIGHT_FEED(8.0000, 488.0000, -10.0000)
1315 STRAIGHT_FEED(8.0000, 210.0000, -10.0000)
1316 STRAIGHT_TRAVERSE(8.0000, 210.0000, 15.0000)
1317 STRAIGHT_TRAVERSE(333.0000, 210.0000, 15.0000)
1318 STRAIGHT_FEED(333.0000, 210.0000, -20.0000)
1319 STRAIGHT_FEED(333.0000, 488.0000, -20.0000)
1320 STRAIGHT_FEED(320.0000, 488.0000, -20.0000)
1321 STRAIGHT_FEED(320.0000, 210.0000, -20.0000)
1322 STRAIGHT_FEED(307.0000, 210.0000, -20.0000)
1323 STRAIGHT_FEED(307.0000, 488.0000, -20.0000)
1324 STRAIGHT_FEED(294.0000, 488.0000, -20.0000)
1325 STRAIGHT_FEED(294.0000, 210.0000, -20.0000)
1326 STRAIGHT_FEED(281.0000, 210.0000, -20.0000)
1327 STRAIGHT_FEED(281.0000, 488.0000, -20.0000)
1328 STRAIGHT_FEED(268.0000, 488.0000, -20.0000)
1329 STRAIGHT_FEED(268.0000, 210.0000, -20.0000)
1330 STRAIGHT_FEED(255.0000, 210.0000, -20.0000)
1331 STRAIGHT_FEED(255.0000, 488.0000, -20.0000)
1332 STRAIGHT_FEED(242.0000, 488.0000, -20.0000)
1333 STRAIGHT_FEED(242.0000, 210.0000, -20.0000)
1334 STRAIGHT_FEED(229.0000, 210.0000, -20.0000)
1335 STRAIGHT_FEED(229.0000, 488.0000, -20.0000)
1336 STRAIGHT_FEED(216.0000, 488.0000, -20.0000)
1337 STRAIGHT_FEED(216.0000, 210.0000, -20.0000)
1338 STRAIGHT_FEED(203.0000, 210.0000, -20.0000)
1339 STRAIGHT_FEED(203.0000, 488.0000, -20.0000)
1340 STRAIGHT_FEED(190.0000, 488.0000, -20.0000)
1341 STRAIGHT_FEED(190.0000, 210.0000, -20.0000)
1342 STRAIGHT_FEED(177.0000, 210.0000, -20.0000)
1343 STRAIGHT_FEED(177.0000, 488.0000, -20.0000)
1344 STRAIGHT_FEED(164.0000, 488.0000, -20.0000)
1345 STRAIGHT_FEED(164.0000, 210.0000, -20.0000)
1346 STRAIGHT_FEED(151.0000, 210.0000, -20.0000)
1347 STRAIGHT_FEED(151.0000, 488.0000, -20.0000)
1348 STRAIGHT_FEED(138.0000, 488.0000, -20.0000)
1349 STRAIGHT_FEED(138.0000, 210.0000, -20.0000)
1350 STRAIGHT_FEED(125.0000, 210.0000, -20.0000)
1351 STRAIGHT_FEED(125.0000, 488.0000, -20.0000)
1352 STRAIGHT_FEED(112.0000, 488.0000, -20.0000)
1353 STRAIGHT_FEED(112.0000, 210.0000, -20.0000)
1354 STRAIGHT_FEED(99.0000, 210.0000, -20.0000)
1355 STRAIGHT_FEED(99.0000, 488.0000, -20.0000)
1356 STRAIGHT_FEED(86.0000, 488.0000, -20.0000)
1357 STRAIGHT_FEED(86.0000, 210.0000, -20.0000)
1358 STRAIGHT_FEED(73.0000, 210.0000, -20.0000)
1359 STRAIGHT_FEED(73.0000, 488.0000, -20.0000)
1360 STRAIGHT_FEED(60.0000, 488.0000, -20.0000)
1361 STRAIGHT_FEED(60.0000, 210.0000, -20.0000)
1362 STRAIGHT_FEED(47.0000, 210.0000, -20.0000)
1363 STRAIGHT_FEED(47.0000, 488.0000, -20.0000)
1364 STRAIGHT_FEED(34.0000, 488.0000, -20.0000)
1365 STRAIGHT_FEED(34.0000, 210.0000, -20.0000)
1366 STRAIGHT_FEED(21.0000, 210.0000, -20.0000)
1367 STRAIGHT_FEED(21.0000, 488.0000, -20.0000)
1368 STRAIGHT_FEED(8.0000, 488.0000, -20.0000)
1369 STRAIGHT_FEED(8.0000, 210.0000, -20.0000)
1370 STRAIGHT_TRAVERSE(8.0000, 210.0000, 15.0000)
1371 STRAIGHT_TRAVERSE(333.0000, 210.0000, 15.0000)
1372 STRAIGHT_FEED(333.0000, 210.0000, -30.0000)
1373 STRAIGHT_FEED(333.0000, 488.0000, -30.0000)
1374 STRAIGHT_FEED(320.0000, 488.0000, -30.0000)
1375 STRAIGHT_FEED(320.0000, 210.0000, -30.0000)
1376 STRAIGHT_FEED(307.0000, 210.0000, -30.0000)
1377 STRAIGHT_FEED(307.0000, 488.0000, -30.0000)
1378 STRAIGHT_FEED(294.0000, 488.0000, -30.0000)
1379 STRAIGHT_FEED(294.0000, 210.0000, -30.0000)
1380 STRAIGHT_FEED(281.0000, 210.0000, -30.0000)
1381 STRAIGHT_FEED(281.0000, 488.0000, -30.0000)
1382 STRAIGHT_FEED(268.0000, 488.0000, -30.0000)
1383 STRAIGHT_FEED(268.0000, 210.0000, -30.0000)
1384 STRAIGHT_FEED(255.0000, 210.0000, -30.0000)
1385 STRAIGHT_FEED(255.0000, 488.0000, -30.0000)
1386 STRAIGHT_FEED(242.0000, 488.0000, -30.0000)
1387 STRAIGHT_FEED(242.0000, 210.0000, -30.0000)
1388 STRAIGHT_FEED(229.0000, 210.0000, -30.0000)
1389 STRAIGHT_FEED(229.0000, 488.0000, -30.0000)
1390 STRAIGHT_FEED(216.0000, 488.0000, -30.0000)
1391 STRAIGHT_FEED(216.0000, 210.0000, -30.0000)
1392 STRAIGHT_FEED(203.0000, 210.0000, -30.0000)
1393 STRAIGHT_FEED(203.0000, 488.0000, -30.0000)
1394 STRAIGHT_FEED(190.0000, 488.0000, -30.0000)
1395 STRAIGHT_FEED(190.0000, 210.0000, -30.0000)
1396 STRAIGHT_FEED(177.0000, 210.0000, -30.0000)
1397 STRAIGHT_FEED(177.0000, 488.0000, -30.0000)
1398 STRAIGHT_FEED(164.0000, 488.0000, -30.0000)
1399 STRAIGHT_FEED(164.0000, 210.0000, -30.0000)
1400 STRAIGHT_FEED(151.0000, 210.0000, -30.0000)
1401 STRAIGHT_FEED(151.0000, 488.0000, -30.0000)
1402 STRAIGHT_FEED(138.0000, 488.0000, -30.0000)
1403 STRAIGHT_FEED(138.0000, 210.0000, -30.0000)
1404 STRAIGHT_FEED(125.0000, 210.0000, -30.0000)
1405 STRAIGHT_FEED(125.0000, 488.0000, -30.0000)
1406 STRAIGHT_FEED(112.0000, 488.0000, -30.0000)
1407 STRAIGHT_FEED(112.0000, 210.0000, -30.0000)
1408 STRAIGHT_FEED(99.0000, 210.0000, -30.0000)
1409 STRAIGHT_FEED(99.0000, 488.0000, -30.0000)
1410 STRAIGHT_FEED(86.0000, 488.0000, -30.0000)
1411 STRAIGHT_FEED(86.0000, 210.0000, -30.0000)
1412 STRAIGHT_FEED(73.0000, 210.0000, -30.0000)
1413 STRAIGHT_FEED(73.0000, 488.0000, -30.0000)
1414 STRAIGHT_FEED(60.0000, 488.0000, -30.0000)
1415 STRAIGHT_FEED(60.0000, 210.0000, -30.0000)
1416 STRAIGHT_FEED(47.0000, 210.0000, -30.0000)
1417 STRAIGHT_FEED(47.0000, 488.0000, -30.0000)
1418 STRAIGHT_FEED(34.0000, 488.0000, -30.0000)
1419 STRAIGHT_FEED(34.0000, 210.0000, -30.0000)
1420 STRAIGHT_FEED(21.0000, 210.0000, -30.0000)
1421 STRAIGHT_FEED(21.0000, 488.0000, -30.0000)
1422 STRAIGHT_FEED(8.0000, 488.0000, -30.0000)
1423 STRAIGHT_FEED(8.0000, 210.0000, -30.0000)
1424 STRAIGHT_TRAVERSE(8.0000, 210.0000, 15.0000)
1425 STOP_SPINDLE_TURNING()
1426 FLOOD_OFF()
1427 SPINDLE_RETRACT()
1428 USE_TOOL_LENGTH_OFFSET(0.0000)
1429 CHANGE_TOOL(MILL 18MM)
1430 USE_TOOL_LENGTH_OFFSET(50.0000)
1431 FLOOD_ON()
1432 START_SPINDLE_CLOCKWISE()
1433 STRAIGHT_TRAVERSE(8.0000, 210.0000, 0.0000)
1434 STRAIGHT_TRAVERSE(68.0000, 282.0000, 0.0000)
1435 STRAIGHT_TRAVERSE(68.0000, 282.0000, -15.0000)
1436 STRAIGHT_FEED(68.0000, 282.0000, -36.5000)
1437 STRAIGHT_FEED(68.0000, 282.0000, -36.5000)
1438 STRAIGHT_FEED(166.0000, 282.0000, -36.5000)
1439 STRAIGHT_TRAVERSE(68.0000, 282.0000, -30.0000)
1440 STRAIGHT_FEED(68.0000, 282.0000, -43.0000)
1441 STRAIGHT_FEED(166.0000, 282.0000, -43.0000)
1442 STRAIGHT_TRAVERSE(68.0000, 282.0000, -36.5000)
1443 STRAIGHT_FEED(68.0000, 282.0000, -49.5000)
1444 STRAIGHT_FEED(166.0000, 282.0000, -49.5000)
1445 STRAIGHT_TRAVERSE(68.0000, 282.0000, -43.0000)
1446 STOP_SPINDLE_TURNING()
1447 FLOOD_OFF()
1448 SPINDLE_RETRACT()
1449 USE_TOOL_LENGTH_OFFSET(0.0000)
1450 CHANGE_TOOL(PROBE_NUM01)
1451 USE_TOOL_LENGTH_OFFSET(50.0000)
1452 TURN_PROBE_ON()
```

```
1453 SET_FEED_RATE(230.0000)
1454 STRAIGHT_PROBE(108.8528, 293.0000, -35.4584)
1455 STRAIGHT_PROBE(109.9888, 293.0000, -33.2347)
1456 STRAIGHT_PROBE(147.9557, 293.0000, -36.6183)
1457 STRAIGHT_PROBE(150.4444, 293.0000, -44.5366)
1458 STRAIGHT_PROBE(112.1876, 293.0000, -47.5079)
1459 STRAIGHT_PROBE(112.1197, 293.0000, -39.0972)
1460 STRAIGHT_PROBE(69.3294, 293.0000, -43.9011)
1461 STRAIGHT_PROBE(74.3923, 293.0000, -33.7820)
1462 STRAIGHT_PROBE(77.2716, 293.0000, -36.2773)
1463 STRAIGHT_PROBE(105.1166, 293.0000, -42.0487)
1464 STRAIGHT_PROBE(123.1029, 273.0000, -41.4630)
1465 STRAIGHT_PROBE(94.7025, 273.0000, -37.2810)
1466 STRAIGHT_PROBE(81.5227, 273.0000, -36.3381)
1467 STRAIGHT_PROBE(60.9165, 273.0000, -44.0083)
1468 STRAIGHT_PROBE(61.2865, 273.0000, -30.3167)
1469 STRAIGHT_PROBE(91.5630, 273.0000, -45.4843)
1470 STRAIGHT_PROBE(140.2721, 273.0000, -36.3129)
1471 STRAIGHT_PROBE(143.6443, 273.0000, -43.7662)
1472 STRAIGHT_PROBE(129.3957, 273.0000, -47.3978)
1473 STRAIGHT_PROBE(125.1079, 273.0000, -33.2533)
1474 TURN_PROBE_OFF()
1475 SPINDLE_RETRACT()
1476 USE_TOOL_LENGTH_OFFSET(0.0000)
1477 CHANGE_TOOL(MILL 20MM)
1478 USE_TOOL_LENGTH_OFFSET(60.0000)
1479 FLOOD_ON()
1480 START_SPINDLE_CLOCKWISE()
1481 STRAIGHT_TRAVERSE(125.1079, 273.0000, 0.0000)
1482 STRAIGHT_TRAVERSE(69.0000, 283.0000, 0.0000)
1483 STRAIGHT_TRAVERSE(69.0000, 283.0000, -15.0000)
1484 STRAIGHT_FEED(69.0000, 283.0000, -40.0000)
1485 STRAIGHT_FEED(69.0000, 283.0000, -40.0000)
1486 STRAIGHT_FEED(169.0000, 283.0000, -40.0000)
1487 STRAIGHT_TRAVERSE(69.0000, 283.0000, -30.0000)
1488 STRAIGHT_FEED(69.0000, 283.0000, -50.0000)
1489 STRAIGHT_FEED(169.0000, 283.0000, -50.0000)
1490 STRAIGHT_TRAVERSE(69.0000, 283.0000, -40.0000)
1491 STOP_SPINDLE_TURNING()
1492 FLOOD_OFF()
1493 SPINDLE_RETRACT()
1494 USE_TOOL_LENGTH_OFFSET(0.0000)
1495 CHANGE_TOOL(SPIRAL_DRILL_16MM)
1496 USE_TOOL_LENGTH_OFFSET(70.0000)
1497 FLOOD_ON()
1498 SET_SPINDLE_SPEED(960.0000)
1499 START_SPINDLE_CLOCKWISE()
1500 SET_FEED_RATE(1800.0000)
1501 STRAIGHT_TRAVERSE(69.0000, 283.0000, 0.0000)
1502 STRAIGHT_TRAVERSE(25.0000, 308.0000, 0.0000)
1503 STRAIGHT_TRAVERSE(25.0000, 308.0000, -20.0000)
1504 SET_SPINDLE_SPEED(720.0000)
1505 SET_FEED_RATE(900.0000)
1506 STRAIGHT_FEED(25.0000, 308.0000, -37.9361)
1507 SET_FEED_RATE(1800.0000)
1508 SET_SPINDLE_SPEED(960.0000)
1509 STRAIGHT_FEED(25.0000, 308.0000, -43.9361)
1510 SET_SPINDLE_SPEED(480.0000)
1511 SET_FEED_RATE(1350.0000)
1512 STRAIGHT_FEED(25.0000, 308.0000, -65.9361)
1513 SET_FEED_RATE(1800.0000)
1514 STRAIGHT_FEED(25.0000, 308.0000, -20.0000)
1515 STOP_SPINDLE_TURNING()
1516 FLOOD_OFF()
1517 SPINDLE_RETRACT()
1518 USE_TOOL_LENGTH_OFFSET(0.0000)
1519 CHANGE_TOOL(PROBE_NUM01)
1520 USE_TOOL_LENGTH_OFFSET(50.0000)
1521 TURN_PROBE_ON()
1522 SET_FEED_RATE(230.0000)
1523 STRAIGHT_PROBE(25.1257, 315.9990, -30.0000)
1524 STRAIGHT_PROBE(32.2386, 304.5938, -30.0000)
1525 STRAIGHT_PROBE(17.3177, 305.7681, -30.0000)
1526 STRAIGHT_PROBE(23.0105, 315.7487, -30.0000)
1527 STRAIGHT_PROBE(26.4991, 315.8583, -45.0000)
1528 STRAIGHT_PROBE(32.0701, 304.2566, -45.0000)
1529 STRAIGHT_PROBE(22.4087, 300.4313, -45.0000)
1530 STRAIGHT_PROBE(17.3177, 310.2319, -45.0000)
1531 TURN_PROBE_OFF()
1532 SPINDLE_RETRACT()
1533 USE_TOOL_LENGTH_OFFSET(0.0000)
1534 CHANGE_TOOL(SPIRAL_DRILL_16MM)
1535 USE_TOOL_LENGTH_OFFSET(70.0000)
1536 FLOOD_ON()
1537 SET_SPINDLE_SPEED(960.0000)
1538 START_SPINDLE_CLOCKWISE()
1539 STRAIGHT_TRAVERSE(17.3177, 310.2319, 0.0000)
1540 STRAIGHT_TRAVERSE(193.0000, 308.0000, 0.0000)
1541 STRAIGHT_TRAVERSE(193.0000, 308.0000, -20.0000)
1542 SET_SPINDLE_SPEED(720.0000)
1543 SET_FEED_RATE(900.0000)
1544 STRAIGHT_FEED(193.0000, 308.0000, -37.9361)
1545 SET_FEED_RATE(1800.0000)
1546 SET_SPINDLE_SPEED(960.0000)
1547 STRAIGHT_FEED(193.0000, 308.0000, -43.9361)
1548 SET_SPINDLE_SPEED(480.0000)
1549 SET_FEED_RATE(1350.0000)
1550 STRAIGHT_FEED(193.0000, 308.0000, -65.9361)
1551 SET_FEED_RATE(1800.0000)
1552 STRAIGHT_FEED(193.0000, 308.0000, -20.0000)
1553 STOP_SPINDLE_TURNING()
1554 FLOOD_OFF()
1555 SPINDLE_RETRACT()
1556 USE_TOOL_LENGTH_OFFSET(0.0000)
1557 CHANGE_TOOL(PROBE_NUM01)
1558 USE_TOOL_LENGTH_OFFSET(50.0000)
1559 TURN_PROBE_ON()
1560 SET_FEED_RATE(230.0000)
1561 STRAIGHT_PROBE(193.7529, 315.9645, -30.0000)
1562 STRAIGHT_PROBE(193.6277, 300.0247, -30.0000)
1563 STRAIGHT_PROBE(188.0967, 301.6788, -30.0000)
1564 STRAIGHT_PROBE(185.1927, 309.7451, -30.0000)
1565 STRAIGHT_PROBE(194.4991, 315.8583, -45.0000)
1566 STRAIGHT_PROBE(200.8809, 306.6246, -45.0000)
1567 STRAIGHT_PROBE(191.2549, 300.1927, -45.0000)
1568 STRAIGHT_PROBE(187.9981, 314.2434, -45.0000)
1569 TURN_PROBE_OFF()
1570 SPINDLE_RETRACT()
1571 USE_TOOL_LENGTH_OFFSET(0.0000)
1572 CHANGE_TOOL(SPIRAL_DRILL_16MM)
1573 USE_TOOL_LENGTH_OFFSET(70.0000)
1574 FLOOD_ON()
1575 SET_SPINDLE_SPEED(960.0000)
1576 START_SPINDLE_CLOCKWISE()
1577 STRAIGHT_TRAVERSE(187.9981, 314.2434, 0.0000)
1578 STRAIGHT_TRAVERSE(25.0000, 258.0000, 0.0000)
1579 STRAIGHT_TRAVERSE(25.0000, 258.0000, -20.0000)
1580 SET_SPINDLE_SPEED(720.0000)
1581 SET_FEED_RATE(900.0000)
1582 STRAIGHT_FEED(25.0000, 258.0000, -37.9361)
1583 SET_FEED_RATE(1800.0000)
1584 SET_SPINDLE_SPEED(960.0000)
1585 STRAIGHT_FEED(25.0000, 258.0000, -43.9361)
1586 SET_SPINDLE_SPEED(480.0000)
1587 SET_FEED_RATE(1350.0000)
1588 STRAIGHT_FEED(25.0000, 258.0000, -65.9361)
1589 SET_FEED_RATE(1800.0000)
1590 STRAIGHT_FEED(25.0000, 258.0000, -20.0000)
1591 STOP_SPINDLE_TURNING()
1592 FLOOD_OFF()
1593 SPINDLE_RETRACT()
1594 USE_TOOL_LENGTH_OFFSET(0.0000)
1595 CHANGE_TOOL(PROBE_NUM01)
1596 USE_TOOL_LENGTH_OFFSET(50.0000)
1597 TURN_PROBE_ON()
1598 SET_FEED_RATE(230.0000)
```

```
1599 STRAIGHT_PROBE(29.9033, 264.3212, -30.0000)
1600 STRAIGHT_PROBE(32.1842, 254.4805, -30.0000)
1601 STRAIGHT_PROBE(17.8158, 254.4805, -30.0000)
1602 STRAIGHT_PROBE(18.8359, 263.0994, -30.0000)
1603 STRAIGHT_PROBE(30.0994, 264.1641, -45.0000)
1604 STRAIGHT_PROBE(26.2515, 250.0985, -45.0000)
1605 STRAIGHT_PROBE(24.1221, 250.0483, -45.0000)
1606 STRAIGHT_PROBE(24.6231, 265.9911, -45.0000)
1607 TURN_PROBE_OFF()
1608 SPINDLE RETRACT()
1609 USE_TOOL_LENGTH_OFFSET(0.0000)
1610 CHANGE_TOOL(SPIRAL_DRILL_16MM)
1611 USE_TOOL_LENGTH_OFFSET(70.0000)
1612 FLOOD_ON()
1613 SET_SPINDLE_SPEED(960.0000)
1614 START_SPINDLE_CLOCKWISE()
1615 STRAIGHT_TRAVERSE(24.6231, 265.9911, 0.0000)
1616 STRAIGHT_TRAVERSE(193.0000, 258.0000, 0.0000)
1617 STRAIGHT_TRAVERSE(193.0000, 258.0000, -20.0000)
1618 SET_SPINDLE_SPEED(720.0000)
1619 SET_FEED_RATE(900.0000)
1620 STRAIGHT_FEED(193.0000, 258.0000, -37.9361)
1621 SET_FEED_RATE(1800.0000)
1622 SET_SPINDLE_SPEED(960.0000)
1623 STRAIGHT_FEED(193.0000, 258.0000, -43.9361)
1624 SET_SPINDLE_SPEED(480.0000)
1625 SET_FEED_RATE(1350.0000)
1626 STRAIGHT_FEED(193.0000, 258.0000, -65.9361)
1627 SET_FEED_RATE(1800.0000)
1628 STRAIGHT_FEED(193.0000, 258.0000, -20.0000)
1629 STOP_SPINDLE_TURNING()
1630 FLOOD_OFF()
1631 SPINDLE RETRACT()
1632 USE_TOOL_LENGTH_OFFSET(0.0000)
1633 CHANGE_TOOL(PROBE_NUM01)
1634 USE_TOOL_LENGTH_OFFSET(50.0000)
1635 TURN_PROBE_ON()
1636 SET_FEED_RATE(230.0000)
1637 STRAIGHT_PROBE(198.3841, 263.9170, -30.0000)
1638 STRAIGHT_PROBE(193.5023, 250.0158, -30.0000)
1639 STRAIGHT_PROBE(189.2566, 250.9299, -30.0000)
1640 STRAIGHT_PROBE(189.8228, 265.3420, -30.0000)
1641 STRAIGHT_PROBE(198.0994, 264.1641, -45.0000)
1642 STRAIGHT_PROBE(200.9961, 257.7487, -45.0000)
1643 STRAIGHT_PROBE(185.0010, 257.8743, -45.0000)
1644 STRAIGHT_PROBE(186.2454, 262.2866, -45.0000)
1645 TURN_PROBE_OFF()
1646 PROGRAM_END()
```

## Appendix C.2 G-code Output

```

N1G54
N2M5
N3G90G28Z0
N4G49Z0.0000
N5T1M6
N6G43H1Z50.0000
N7F230.0000
N8G0G49G80G40
N9G0G49G80G40
N10G49Z0.0000
N11T2M6
N12G43H1Z60.0000
N13M8
N14M3
N15S1200.0000
N16F2400.0000
N17G0X200.0000Y-30.0000Z200.0000
N18X200.0000Y-30.0000Z15.0000
N19G1X200.0000Y-30.0000Z2.5000
N20X200.0000Y356.0000Z2.5000
N21X162.0000Y356.0000Z2.5000
N22X162.0000Y-30.0000Z2.5000
N23X124.0000Y-30.0000Z2.5000
N24X124.0000Y356.0000Z2.5000
N25X86.0000Y356.0000Z2.5000
N26X86.0000Y-30.0000Z2.5000
N27X48.0000Y-30.0000Z2.5000
N28X48.0000Y356.0000Z2.5000
N29X10.0000Y356.0000Z2.5000
N30X10.0000Y-30.0000Z2.5000
N31G0X10.0000Y-30.0000Z15.0000
N32X200.0000Y-30.0000Z15.0000
N33G1X200.0000Y-30.0000Z0.0000
N34X200.0000Y356.0000Z0.0000
N35X162.0000Y356.0000Z0.0000
N36X162.0000Y-30.0000Z0.0000
N37X124.0000Y-30.0000Z0.0000
N38X124.0000Y356.0000Z0.0000
N39X86.0000Y356.0000Z0.0000
N40X86.0000Y-30.0000Z0.0000
N41X48.0000Y-30.0000Z0.0000
N42X48.0000Y356.0000Z0.0000
N43X10.0000Y356.0000Z0.0000
N44X10.0000Y-30.0000Z0.0000
N45G0X10.0000Y-30.0000Z15.0000
N46M5
N47M9
N48G0G49G80G40
N49G49Z0.0000
N50T3M6
N51G43H1Z50.0000
N52M8
N53M3
N54S1200.0000
N55X10.0000Y-30.0000Z30.0000
N56X55.5000Y176.5000Z30.0000
N57X55.5000Y176.5000Z15.0000
N58G1X55.5000Y176.5000Z-8.1000
N59X78.5000Y176.5000Z-8.1000
N60X85.8333Y176.5000Z-8.1000
N61X85.8333Y169.1667Z-8.1000
N62X48.1667Y169.1667Z-8.1000
N63X48.1667Y183.8333Z-8.1000
N64X85.8333Y183.8333Z-8.1000
N65X85.8333Y176.5000Z-8.1000
N66X93.1667Y176.5000Z-8.1000
N67X93.1667Y161.8333Z-8.1000
N68X40.8333Y161.8333Z-8.1000
N69X40.8333Y191.1667Z-8.1000
N70X93.1667Y191.1667Z-8.1000
N71X93.1667Y176.5000Z-8.1000
N72X100.5000Y176.5000Z-8.1000
N73X100.5000Y154.5000Z-8.1000
N74X33.5000Y154.5000Z-8.1000
N75X33.5000Y198.5000Z-8.1000
N76X100.5000Y198.5000Z-8.1000
N77X100.5000Y176.5000Z-8.1000
N78X100.5000Y176.5000Z0.0000
N79G0X55.5000Y176.5000Z0.0000
N80G1X55.5000Y176.5000Z-8.1000
N81X55.5000Y176.5000Z-16.2000
N82X78.5000Y176.5000Z-16.2000
N83X85.8333Y176.5000Z-16.2000
N84X85.8333Y169.1667Z-16.2000
N85X48.1667Y169.1667Z-16.2000
N86X48.1667Y183.8333Z-16.2000
N87X85.8333Y183.8333Z-16.2000
N88X85.8333Y176.5000Z-16.2000
N89X93.1667Y176.5000Z-16.2000
N90X93.1667Y161.8333Z-16.2000
N91X40.8333Y161.8333Z-16.2000
N92X40.8333Y191.1667Z-16.2000
N93X93.1667Y191.1667Z-16.2000
N94X93.1667Y176.5000Z-16.2000
N95X100.5000Y176.5000Z-16.2000
N96X100.5000Y154.5000Z-16.2000
N97X33.5000Y154.5000Z-16.2000
N98X33.5000Y198.5000Z-16.2000
N99X100.5000Y198.5000Z-16.2000
N100X100.5000Y176.5000Z-16.2000
N101X100.5000Y176.5000Z-8.1000
N102G0X55.5000Y176.5000Z-8.1000
N103G1X55.5000Y176.5000Z-16.2000
N104X55.5000Y176.5000Z-24.3000
N105X78.5000Y176.5000Z-24.3000
N106X85.8333Y176.5000Z-24.3000
N107X85.8333Y169.1667Z-24.3000
N108X48.1667Y169.1667Z-24.3000
N109X48.1667Y183.8333Z-24.3000
N110X85.8333Y183.8333Z-24.3000
N111X85.8333Y176.5000Z-24.3000
N112X93.1667Y176.5000Z-24.3000
N113X93.1667Y161.8333Z-24.3000
N114X40.8333Y161.8333Z-24.3000
N115X40.8333Y191.1667Z-24.3000
N116X93.1667Y191.1667Z-24.3000
N117X93.1667Y176.5000Z-24.3000
N118X100.5000Y176.5000Z-24.3000
N119X100.5000Y154.5000Z-24.3000
N120X33.5000Y154.5000Z-24.3000
N121X33.5000Y198.5000Z-24.3000
N122X100.5000Y198.5000Z-24.3000

```

N123X100.5000Y176.5000Z-24.3000  
 N124X100.5000Y176.5000Z-16.2000  
 N125G0X55.5000Y176.5000Z-16.2000  
 N126G1X55.5000Y176.5000Z-24.3000  
 N127X55.5000Y176.5000Z-32.4000  
 N128X78.5000Y176.5000Z-32.4000  
 N129X85.8333Y176.5000Z-32.4000  
 N130X85.8333Y169.1667Z-32.4000  
 N131X48.1667Y169.1667Z-32.4000  
 N132X48.1667Y183.8333Z-32.4000  
 N133X85.8333Y183.8333Z-32.4000  
 N134X85.8333Y176.5000Z-32.4000  
 N135X93.1667Y176.5000Z-32.4000  
 N136X93.1667Y161.8333Z-32.4000  
 N137X40.8333Y161.8333Z-32.4000  
 N138X40.8333Y191.1667Z-32.4000  
 N139X93.1667Y191.1667Z-32.4000  
 N140X93.1667Y176.5000Z-32.4000  
 N141X100.5000Y176.5000Z-32.4000  
 N142X100.5000Y154.5000Z-32.4000  
 N143X33.5000Y154.5000Z-32.4000  
 N144X33.5000Y198.5000Z-32.4000  
 N145X100.5000Y198.5000Z-32.4000  
 N146X100.5000Y176.5000Z-32.4000  
 N147X100.5000Y176.5000Z-24.3000  
 N148G0X55.5000Y176.5000Z-24.3000  
 N149G1X55.5000Y176.5000Z-32.4000  
 N150X55.5000Y176.5000Z-40.5000  
 N151X78.5000Y176.5000Z-40.5000  
 N152X85.8333Y176.5000Z-40.5000  
 N153X85.8333Y169.1667Z-40.5000  
 N154X48.1667Y169.1667Z-40.5000  
 N155X48.1667Y183.8333Z-40.5000  
 N156X85.8333Y183.8333Z-40.5000  
 N157X85.8333Y176.5000Z-40.5000  
 N158X93.1667Y176.5000Z-40.5000  
 N159X93.1667Y161.8333Z-40.5000  
 N160X40.8333Y161.8333Z-40.5000  
 N161X40.8333Y191.1667Z-40.5000  
 N162X93.1667Y191.1667Z-40.5000  
 N163X93.1667Y176.5000Z-40.5000  
 N164X100.5000Y176.5000Z-40.5000  
 N165X100.5000Y154.5000Z-40.5000  
 N166X33.5000Y154.5000Z-40.5000  
 N167X33.5000Y198.5000Z-40.5000  
 N168X100.5000Y198.5000Z-40.5000  
 N169X100.5000Y176.5000Z-40.5000  
 N170X100.5000Y176.5000Z15.0000  
 N171G0X100.5000Y176.5000Z30.0000  
 N172X121.0000Y143.0000Z30.0000  
 N173X121.0000Y143.0000Z15.0000  
 N174G1X121.0000Y143.0000Z-8.1000  
 N175X199.0000Y143.0000Z-8.1000  
 N176X199.0000Y228.0000Z-8.1000  
 N177X121.0000Y228.0000Z-8.1000  
 N178X121.0000Y143.0000Z-8.1000  
 N179X123.5000Y145.5000Z-8.1000  
 N180X196.5000Y145.5000Z-8.1000  
 N181X196.5000Y225.5000Z-8.1000  
 N182X123.5000Y225.5000Z-8.1000  
 N183X123.5000Y145.5000Z-8.1000  
 N184X123.5000Y148.0000Z-8.1000  
 N185G0X121.0000Y143.0000Z0.0000  
 N186G1X121.0000Y143.0000Z-16.2000  
 N187X199.0000Y143.0000Z-16.2000  
 N188X199.0000Y228.0000Z-16.2000  
 N189X121.0000Y228.0000Z-16.2000  
 N190X121.0000Y143.0000Z-16.2000  
 N191X123.5000Y145.5000Z-16.2000  
 N192X196.5000Y145.5000Z-16.2000  
 N193X196.5000Y225.5000Z-16.2000  
 N194X123.5000Y225.5000Z-16.2000  
 N195X123.5000Y145.5000Z-16.2000  
 N196X123.5000Y148.0000Z-16.2000  
 N197G0X121.0000Y143.0000Z-8.1000  
 N198G1X121.0000Y143.0000Z-24.3000  
 N199X199.0000Y143.0000Z-24.3000  
 N200X199.0000Y228.0000Z-24.3000  
 N201X121.0000Y228.0000Z-24.3000  
 N202X121.0000Y143.0000Z-24.3000  
 N203X123.5000Y145.5000Z-24.3000  
 N204X196.5000Y145.5000Z-24.3000  
 N205X196.5000Y225.5000Z-24.3000  
 N206X123.5000Y225.5000Z-24.3000  
 N207X123.5000Y145.5000Z-24.3000  
 N208X123.5000Y148.0000Z-24.3000  
 N209G0X121.0000Y143.0000Z-16.2000  
 N210G1X121.0000Y143.0000Z-32.4000  
 N211X199.0000Y143.0000Z-32.4000  
 N212X199.0000Y228.0000Z-32.4000  
 N213X121.0000Y228.0000Z-32.4000  
 N214X121.0000Y143.0000Z-32.4000  
 N215X123.5000Y145.5000Z-32.4000  
 N216X196.5000Y145.5000Z-32.4000  
 N217X196.5000Y225.5000Z-32.4000  
 N218X123.5000Y225.5000Z-32.4000  
 N219X123.5000Y145.5000Z-32.4000  
 N220X123.5000Y148.0000Z-32.4000  
 N221G0X121.0000Y143.0000Z-24.3000  
 N222G1X121.0000Y143.0000Z-40.5000  
 N223X199.0000Y143.0000Z-40.5000  
 N224X199.0000Y228.0000Z-40.5000  
 N225X121.0000Y228.0000Z-40.5000  
 N226X121.0000Y143.0000Z-40.5000  
 N227X123.5000Y145.5000Z-40.5000  
 N228X196.5000Y145.5000Z-40.5000  
 N229X196.5000Y225.5000Z-40.5000  
 N230X123.5000Y225.5000Z-40.5000  
 N231X123.5000Y145.5000Z-40.5000  
 N232X123.5000Y148.0000Z-40.5000  
 N233G0X121.0000Y143.0000Z-32.4000  
 N234M5  
 N235M9  
 N236G0G49G80G40  
 N237G49Z0.0000  
 N238T1M6  
 N239G43H1Z50.0000  
 N240F230.0000  
 N241G0G49G80G40  
 N242G49Z0.0000  
 N243T1M6  
 N244G43H1Z50.0000  
 N245F230.0000  
 N246G0G49G80G40  
 N247G49Z0.0000  
 N248T3M6  
 N249G43H1Z50.0000  
 N250M8  
 N251M3  
 N252S1200.0000

N253X145.5471Y158.0000Z30.0000  
N254X120.0000Y142.0000Z30.0000  
N255X120.0000Y142.0000Z15.0000  
N256G1X120.0000Y142.0000Z-10.2500  
N257X200.0000Y142.0000Z-10.2500  
N258X200.0000Y229.0000Z-10.2500  
N259X120.0000Y229.0000Z-10.2500  
N260X120.0000Y142.0000Z-10.2500  
N261X123.5000Y145.5000Z-10.2500  
N262X196.5000Y145.5000Z-10.2500  
N263X196.5000Y225.5000Z-10.2500  
N264X123.5000Y225.5000Z-10.2500  
N265X123.5000Y145.5000Z-10.2500  
N266X123.5000Y149.0000Z-10.2500  
N267G0X120.0000Y142.0000Z0.0000  
N268G1X120.0000Y142.0000Z-20.5000  
N269X200.0000Y142.0000Z-20.5000  
N270X200.0000Y229.0000Z-20.5000  
N271X120.0000Y229.0000Z-20.5000  
N272X120.0000Y142.0000Z-20.5000  
N273X123.5000Y145.5000Z-20.5000  
N274X196.5000Y145.5000Z-20.5000  
N275X196.5000Y225.5000Z-20.5000  
N276X123.5000Y225.5000Z-20.5000  
N277X123.5000Y145.5000Z-20.5000  
N278X123.5000Y149.0000Z-20.5000  
N279G0X120.0000Y142.0000Z-10.2500  
N280G1X120.0000Y142.0000Z-30.7500  
N281X200.0000Y142.0000Z-30.7500  
N282X200.0000Y229.0000Z-30.7500  
N283X120.0000Y229.0000Z-30.7500  
N284X120.0000Y142.0000Z-30.7500  
N285X123.5000Y145.5000Z-30.7500  
N286X196.5000Y145.5000Z-30.7500  
N287X196.5000Y225.5000Z-30.7500  
N288X123.5000Y225.5000Z-30.7500  
N289X123.5000Y145.5000Z-30.7500  
N290X123.5000Y149.0000Z-30.7500  
N291G0X120.0000Y142.0000Z-20.5000  
N292G1X120.0000Y142.0000Z-41.0000  
N293X200.0000Y142.0000Z-41.0000  
N294X200.0000Y229.0000Z-41.0000  
N295X120.0000Y229.0000Z-41.0000  
N296X120.0000Y142.0000Z-41.0000  
N297X123.5000Y145.5000Z-41.0000  
N298X196.5000Y145.5000Z-41.0000  
N299X196.5000Y225.5000Z-41.0000  
N300X123.5000Y225.5000Z-41.0000  
N301X123.5000Y145.5000Z-41.0000  
N302X123.5000Y149.0000Z-41.0000  
N303G0X120.0000Y142.0000Z-30.7500  
N304X120.0000Y142.0000Z30.0000  
N305X48.0000Y0.0000Z30.0000  
N306X48.0000Y0.0000Z15.0000  
N307G1X48.0000Y0.0000Z-7.1667  
N308X48.0000Y0.0000Z-7.1667  
N309X48.0000Y0.0000Z-7.1667  
N310X168.0000Y0.0000Z-7.1667  
N311X168.0000Y114.0000Z-7.1667  
N312X48.0000Y114.0000Z-7.1667  
N313X48.0000Y0.0000Z-7.1667  
N314X48.0000Y8.5000Z-7.1667  
N315X56.5000Y8.5000Z-7.1667  
N316X159.5000Y8.5000Z-7.1667  
N317X159.5000Y105.5000Z-7.1667  
N318X56.5000Y105.5000Z-7.1667  
N319X56.5000Y8.5000Z-7.1667  
N320X56.5000Y17.0000Z-7.1667  
N321X65.0000Y17.0000Z-7.1667  
N322X151.0000Y17.0000Z-7.1667  
N323X151.0000Y97.0000Z-7.1667  
N324X65.0000Y97.0000Z-7.1667  
N325X65.0000Y17.0000Z-7.1667  
N326X65.0000Y25.5000Z-7.1667  
N327X73.5000Y25.5000Z-7.1667  
N328X142.5000Y25.5000Z-7.1667  
N329X142.5000Y88.5000Z-7.1667  
N330X73.5000Y88.5000Z-7.1667  
N331X73.5000Y25.5000Z-7.1667  
N332X73.5000Y34.0000Z-7.1667  
N333X82.0000Y34.0000Z-7.1667  
N334X134.0000Y34.0000Z-7.1667  
N335X134.0000Y80.0000Z-7.1667  
N336X82.0000Y80.0000Z-7.1667  
N337X82.0000Y34.0000Z-7.1667  
N338X82.0000Y42.5000Z-7.1667  
N339X90.5000Y42.5000Z-7.1667  
N340X125.5000Y42.5000Z-7.1667  
N341X125.5000Y71.5000Z-7.1667  
N342X90.5000Y71.5000Z-7.1667  
N343X90.5000Y42.5000Z-7.1667  
N344X90.5000Y51.0000Z-7.1667  
N345G0X48.0000Y0.0000Z0.0000  
N346G1X48.0000Y0.0000Z-14.3333  
N347X48.0000Y0.0000Z-14.3333  
N348X168.0000Y0.0000Z-14.3333  
N349X168.0000Y114.0000Z-14.3333  
N350X48.0000Y114.0000Z-14.3333  
N351X48.0000Y0.0000Z-14.3333  
N352X48.0000Y8.5000Z-14.3333  
N353X56.5000Y8.5000Z-14.3333  
N354X159.5000Y8.5000Z-14.3333  
N355X159.5000Y105.5000Z-14.3333  
N356X56.5000Y105.5000Z-14.3333  
N357X56.5000Y8.5000Z-14.3333  
N358X56.5000Y17.0000Z-14.3333  
N359X65.0000Y17.0000Z-14.3333  
N360X151.0000Y17.0000Z-14.3333  
N361X151.0000Y97.0000Z-14.3333  
N362X65.0000Y97.0000Z-14.3333  
N363X65.0000Y17.0000Z-14.3333  
N364X65.0000Y25.5000Z-14.3333  
N365X73.5000Y25.5000Z-14.3333  
N366X142.5000Y25.5000Z-14.3333  
N367X142.5000Y88.5000Z-14.3333  
N368X73.5000Y88.5000Z-14.3333  
N369X73.5000Y25.5000Z-14.3333  
N370X73.5000Y34.0000Z-14.3333  
N371X82.0000Y34.0000Z-14.3333  
N372X134.0000Y34.0000Z-14.3333  
N373X134.0000Y80.0000Z-14.3333  
N374X82.0000Y80.0000Z-14.3333  
N375X82.0000Y34.0000Z-14.3333  
N376X82.0000Y42.5000Z-14.3333  
N377X90.5000Y42.5000Z-14.3333  
N378X125.5000Y42.5000Z-14.3333  
N379X125.5000Y71.5000Z-14.3333  
N380X90.5000Y71.5000Z-14.3333  
N381X90.5000Y42.5000Z-14.3333  
N382X90.5000Y51.0000Z-14.3333



N383G0X48.0000Y0.0000Z-7.1667  
N384G1X48.0000Y0.0000Z-21.5000  
N385X48.0000Y0.0000Z-21.5000  
N386X168.0000Y0.0000Z-21.5000  
N387X168.0000Y114.0000Z-21.5000  
N388X48.0000Y114.0000Z-21.5000  
N389X48.0000Y0.0000Z-21.5000  
N390X48.0000Y8.5000Z-21.5000  
N391X56.5000Y8.5000Z-21.5000  
N392X159.5000Y8.5000Z-21.5000  
N393X159.5000Y105.5000Z-21.5000  
N394X56.5000Y105.5000Z-21.5000  
N395X56.5000Y8.5000Z-21.5000  
N396X56.5000Y17.0000Z-21.5000  
N397X65.0000Y17.0000Z-21.5000  
N398X151.0000Y17.0000Z-21.5000  
N399X151.0000Y97.0000Z-21.5000  
N400X65.0000Y97.0000Z-21.5000  
N401X65.0000Y17.0000Z-21.5000  
N402X65.0000Y25.5000Z-21.5000  
N403X73.5000Y25.5000Z-21.5000  
N404X142.5000Y25.5000Z-21.5000  
N405X142.5000Y88.5000Z-21.5000  
N406X73.5000Y88.5000Z-21.5000  
N407X73.5000Y25.5000Z-21.5000  
N408X73.5000Y34.0000Z-21.5000  
N409X82.0000Y34.0000Z-21.5000  
N410X134.0000Y34.0000Z-21.5000  
N411X134.0000Y80.0000Z-21.5000  
N412X82.0000Y80.0000Z-21.5000  
N413X82.0000Y34.0000Z-21.5000  
N414X82.0000Y42.5000Z-21.5000  
N415X90.5000Y42.5000Z-21.5000  
N416X125.5000Y42.5000Z-21.5000  
N417X125.5000Y71.5000Z-21.5000  
N418X90.5000Y71.5000Z-21.5000  
N419X90.5000Y42.5000Z-21.5000  
N420X90.5000Y51.0000Z-21.5000  
N421G0X48.0000Y0.0000Z-14.3333  
N422M5  
N423M9  
N424G0G49G80G40  
N425G49Z0.0000  
N426T1M6  
N427G43H1Z50.0000  
N428F230.0000  
N429G0G49G80G40  
N430G49Z0.0000  
N431T3M6  
N432G43H1Z50.0000  
N433M8  
N434M3  
N435S1200.0000  
N436X170.0000Y68.6998Z30.0000  
N437X48.0000Y0.0000Z30.0000  
N438X48.0000Y0.0000Z15.0000  
N439G1X48.0000Y0.0000Z-11.0000  
N440X48.0000Y0.0000Z-11.0000  
N441X48.0000Y0.0000Z-11.0000  
N442X170.0000Y0.0000Z-11.0000  
N443X170.0000Y116.0000Z-11.0000  
N444X48.0000Y116.0000Z-11.0000  
N445X48.0000Y0.0000Z-11.0000  
N446X48.0000Y13.0000Z-11.0000  
N447X61.0000Y13.0000Z-11.0000  
N448X157.0000Y13.0000Z-11.0000  
N449X157.0000Y103.0000Z-11.0000  
N450X61.0000Y103.0000Z-11.0000  
N451X61.0000Y13.0000Z-11.0000  
N452X61.0000Y26.0000Z-11.0000  
N453X74.0000Y26.0000Z-11.0000  
N454X144.0000Y26.0000Z-11.0000  
N455X144.0000Y90.0000Z-11.0000  
N456X74.0000Y90.0000Z-11.0000  
N457X74.0000Y26.0000Z-11.0000  
N458X74.0000Y39.0000Z-11.0000  
N459X87.0000Y39.0000Z-11.0000  
N460X131.0000Y39.0000Z-11.0000  
N461X131.0000Y77.0000Z-11.0000  
N462X87.0000Y77.0000Z-11.0000  
N463X87.0000Y39.0000Z-11.0000  
N464X87.0000Y52.0000Z-11.0000  
N465G0X48.0000Y0.0000Z0.0000  
N466G1X48.0000Y0.0000Z-22.0000  
N467X48.0000Y0.0000Z-22.0000  
N468X170.0000Y0.0000Z-22.0000  
N469X170.0000Y116.0000Z-22.0000  
N470X48.0000Y116.0000Z-22.0000  
N471X48.0000Y0.0000Z-22.0000  
N472X48.0000Y13.0000Z-22.0000  
N473X61.0000Y13.0000Z-22.0000  
N474X157.0000Y13.0000Z-22.0000  
N475X157.0000Y103.0000Z-22.0000  
N476X61.0000Y103.0000Z-22.0000  
N477X61.0000Y13.0000Z-22.0000  
N478X61.0000Y26.0000Z-22.0000  
N479X74.0000Y26.0000Z-22.0000  
N480X144.0000Y26.0000Z-22.0000  
N481X144.0000Y90.0000Z-22.0000  
N482X74.0000Y90.0000Z-22.0000  
N483X74.0000Y26.0000Z-22.0000  
N484X74.0000Y39.0000Z-22.0000  
N485X87.0000Y39.0000Z-22.0000  
N486X131.0000Y39.0000Z-22.0000  
N487X131.0000Y77.0000Z-22.0000  
N488X87.0000Y77.0000Z-22.0000  
N489X87.0000Y39.0000Z-22.0000  
N490X87.0000Y52.0000Z-22.0000  
N491G0X48.0000Y0.0000Z-11.0000  
N492M5  
N493M9  
N494G0G49G80G40  
N495G49Z0.0000  
N496T2M6  
N497G43H1Z60.0000  
N498M8  
N499M3  
N500S1200.0000  
N501X48.0000Y0.0000Z8.0000  
N502X79.8532Y-5.5127Z8.0000  
N503X79.8532Y-5.5127Z-7.0000  
N504G1X79.8532Y-5.5127Z-27.6250  
N505X103.3797Y76.0000Z-27.6250  
N506X121.9816Y76.0000Z-27.6250  
N507X138.5189Y-5.5127Z-27.6250  
N508X98.0711Y-5.5127Z-27.6250  
N509X107.3720Y32.4363Z-27.6250  
N510X116.6730Y-5.5127Z-27.6250  
N511G0X79.8532Y-5.5127Z-22.0000  
N512G1X103.3797Y76.0000Z-33.2500

N513X121.9816Y76.0000Z-33.2500  
N514X138.5189Y-5.5127Z-33.2500  
N515X98.0711Y-5.5127Z-33.2500  
N516X107.3720Y32.4363Z-33.2500  
N517X116.6730Y-5.5127Z-33.2500  
N518G0X79.8532Y-5.5127Z-27.6250  
N519G1X103.3797Y76.0000Z-38.8750  
N520X121.9816Y76.0000Z-38.8750  
N521X138.5189Y-5.5127Z-38.8750  
N522X98.0711Y-5.5127Z-38.8750  
N523X107.3720Y32.4363Z-38.8750  
N524X116.6730Y-5.5127Z-38.8750  
N525G0X79.8532Y-5.5127Z-33.2500  
N526G1X103.3797Y76.0000Z-44.5000  
N527X121.9816Y76.0000Z-44.5000  
N528X138.5189Y-5.5127Z-44.5000  
N529X98.0711Y-5.5127Z-44.5000  
N530X107.3720Y32.4363Z-44.5000  
N531X116.6730Y-5.5127Z-44.5000  
N532G0X79.8532Y-5.5127Z-38.8750  
N533M5  
N534M9  
N535G0G49G80G40  
N536G49Z0.0000  
N537T1M6  
N538G43H1Z50.0000  
N539F230.0000  
N540G0G49G80G40  
N541G49Z0.0000  
N542T2M6  
N543G43H1Z60.0000  
N544M8  
N545M3  
N546S1200.0000  
N547X65.4299Y29.3987Z8.0000  
N548X76.2252Y-5.5127Z8.0000  
N549X76.2252Y-5.5127Z-7.0000  
N550G1X76.2252Y-5.5127Z-23.9167  
N551X99.7517Y77.0000Z-23.9167  
N552X125.6096Y77.0000Z-23.9167  
N553X145.7748Y-5.5127Z-23.9167  
N554X98.0711Y-5.5127Z-23.9167  
N555X111.0000Y45.0885Z-23.9167  
N556X123.9289Y-5.5127Z-23.9167  
N557G0X76.2252Y-5.5127Z-22.0000  
N558G1X99.7517Y77.0000Z-25.8333  
N559X125.6096Y77.0000Z-25.8333  
N560X145.7748Y-5.5127Z-25.8333  
N561X98.0711Y-5.5127Z-25.8333  
N562X111.0000Y45.0885Z-25.8333  
N563X123.9289Y-5.5127Z-25.8333  
N564G0X76.2252Y-5.5127Z-23.9167  
N565G1X99.7517Y77.0000Z-27.7500  
N566X125.6096Y77.0000Z-27.7500  
N567X145.7748Y-5.5127Z-27.7500  
N568X98.0711Y-5.5127Z-27.7500  
N569X111.0000Y45.0885Z-27.7500  
N570X123.9289Y-5.5127Z-27.7500  
N571G0X76.2252Y-5.5127Z-25.8333  
N572G1X99.7517Y77.0000Z-29.6667  
N573X125.6096Y77.0000Z-29.6667  
N574X145.7748Y-5.5127Z-29.6667  
N575X98.0711Y-5.5127Z-29.6667  
N576X111.0000Y45.0885Z-29.6667  
N577X123.9289Y-5.5127Z-29.6667  
N578G0X76.2252Y-5.5127Z-27.7500  
N579G1X99.7517Y77.0000Z-31.5833  
N580X125.6096Y77.0000Z-31.5833  
N581X145.7748Y-5.5127Z-31.5833  
N582X98.0711Y-5.5127Z-31.5833  
N583X111.0000Y45.0885Z-31.5833  
N584X123.9289Y-5.5127Z-31.5833  
N585G0X76.2252Y-5.5127Z-29.6667  
N586G1X99.7517Y77.0000Z-33.5000  
N587X125.6096Y77.0000Z-33.5000  
N588X145.7748Y-5.5127Z-33.5000  
N589X98.0711Y-5.5127Z-33.5000  
N590X111.0000Y45.0885Z-33.5000  
N591X123.9289Y-5.5127Z-33.5000  
N592G0X76.2252Y-5.5127Z-31.5833  
N593G1X99.7517Y77.0000Z-35.4167  
N594X125.6096Y77.0000Z-35.4167  
N595X145.7748Y-5.5127Z-35.4167  
N596X98.0711Y-5.5127Z-35.4167  
N597X111.0000Y45.0885Z-35.4167  
N598X123.9289Y-5.5127Z-35.4167  
N599G0X76.2252Y-5.5127Z-33.5000  
N600G1X99.7517Y77.0000Z-37.3333  
N601X125.6096Y77.0000Z-37.3333  
N602X145.7748Y-5.5127Z-37.3333  
N603X98.0711Y-5.5127Z-37.3333  
N604X111.0000Y45.0885Z-37.3333  
N605X123.9289Y-5.5127Z-37.3333  
N606G0X76.2252Y-5.5127Z-35.4167  
N607G1X99.7517Y77.0000Z-39.2500  
N608X125.6096Y77.0000Z-39.2500  
N609X145.7748Y-5.5127Z-39.2500  
N610X98.0711Y-5.5127Z-39.2500  
N611X111.0000Y45.0885Z-39.2500  
N612X123.9289Y-5.5127Z-39.2500  
N613G0X76.2252Y-5.5127Z-37.3333  
N614G1X99.7517Y77.0000Z-41.1667  
N615X125.6096Y77.0000Z-41.1667  
N616X145.7748Y-5.5127Z-41.1667  
N617X98.0711Y-5.5127Z-41.1667  
N618X111.0000Y45.0885Z-41.1667  
N619X123.9289Y-5.5127Z-41.1667  
N620G0X76.2252Y-5.5127Z-39.2500  
N621G1X99.7517Y77.0000Z-43.0833  
N622X125.6096Y77.0000Z-43.0833  
N623X145.7748Y-5.5127Z-43.0833  
N624X98.0711Y-5.5127Z-43.0833  
N625X111.0000Y45.0885Z-43.0833  
N626X123.9289Y-5.5127Z-43.0833  
N627G0X76.2252Y-5.5127Z-41.1667  
N628G1X99.7517Y77.0000Z-45.0000  
N629X125.6096Y77.0000Z-45.0000  
N630X145.7748Y-5.5127Z-45.0000  
N631X98.0711Y-5.5127Z-45.0000  
N632X111.0000Y45.0885Z-45.0000  
N633X123.9289Y-5.5127Z-45.0000  
N634G0X76.2252Y-5.5127Z-43.0833  
N635X76.2252Y-5.5127Z30.0000  
N636X233.0000Y210.0000Z30.0000  
N637X233.0000Y210.0000Z15.0000  
N638G1X233.0000Y210.0000Z-5.9000  
N639X233.0000Y356.0000Z-5.9000  
N640X228.0000Y356.0000Z-5.9000  
N641X228.0000Y210.0000Z-5.9000  
N642X223.0000Y210.0000Z-5.9000

N643X223.0000Y356.0000Z-5.9000  
N644X218.0000Y356.0000Z-5.9000  
N645X218.0000Y210.0000Z-5.9000  
N646X213.0000Y210.0000Z-5.9000  
N647X213.0000Y356.0000Z-5.9000  
N648X208.0000Y356.0000Z-5.9000  
N649X208.0000Y210.0000Z-5.9000  
N650X203.0000Y210.0000Z-5.9000  
N651X203.0000Y356.0000Z-5.9000  
N652X198.0000Y356.0000Z-5.9000  
N653X198.0000Y210.0000Z-5.9000  
N654X193.0000Y210.0000Z-5.9000  
N655X193.0000Y356.0000Z-5.9000  
N656X188.0000Y356.0000Z-5.9000  
N657X188.0000Y210.0000Z-5.9000  
N658X183.0000Y210.0000Z-5.9000  
N659X183.0000Y356.0000Z-5.9000  
N660X178.0000Y356.0000Z-5.9000  
N661X178.0000Y210.0000Z-5.9000  
N662X173.0000Y210.0000Z-5.9000  
N663X173.0000Y356.0000Z-5.9000  
N664X168.0000Y356.0000Z-5.9000  
N665X168.0000Y210.0000Z-5.9000  
N666X163.0000Y210.0000Z-5.9000  
N667X163.0000Y356.0000Z-5.9000  
N668X158.0000Y356.0000Z-5.9000  
N669X158.0000Y210.0000Z-5.9000  
N670X153.0000Y210.0000Z-5.9000  
N671X153.0000Y356.0000Z-5.9000  
N672X148.0000Y356.0000Z-5.9000  
N673X148.0000Y210.0000Z-5.9000  
N674X143.0000Y210.0000Z-5.9000  
N675X143.0000Y356.0000Z-5.9000  
N676X138.0000Y356.0000Z-5.9000  
N677X138.0000Y210.0000Z-5.9000  
N678X133.0000Y210.0000Z-5.9000  
N679X133.0000Y356.0000Z-5.9000  
N680X128.0000Y356.0000Z-5.9000  
N681X128.0000Y210.0000Z-5.9000  
N682X123.0000Y210.0000Z-5.9000  
N683X123.0000Y356.0000Z-5.9000  
N684X118.0000Y356.0000Z-5.9000  
N685X118.0000Y210.0000Z-5.9000  
N686X113.0000Y210.0000Z-5.9000  
N687X113.0000Y356.0000Z-5.9000  
N688X108.0000Y356.0000Z-5.9000  
N689X108.0000Y210.0000Z-5.9000  
N690X103.0000Y210.0000Z-5.9000  
N691X103.0000Y356.0000Z-5.9000  
N692X98.0000Y356.0000Z-5.9000  
N693X98.0000Y210.0000Z-5.9000  
N694X93.0000Y210.0000Z-5.9000  
N695X93.0000Y356.0000Z-5.9000  
N696X88.0000Y356.0000Z-5.9000  
N697X88.0000Y210.0000Z-5.9000  
N698X83.0000Y210.0000Z-5.9000  
N699X83.0000Y356.0000Z-5.9000  
N700X78.0000Y356.0000Z-5.9000  
N701X78.0000Y210.0000Z-5.9000  
N702X73.0000Y210.0000Z-5.9000  
N703X73.0000Y356.0000Z-5.9000  
N704X68.0000Y356.0000Z-5.9000  
N705X68.0000Y210.0000Z-5.9000  
N706X63.0000Y210.0000Z-5.9000  
N707X63.0000Y356.0000Z-5.9000  
N708X58.0000Y356.0000Z-5.9000  
N709X58.0000Y210.0000Z-5.9000  
N710X53.0000Y210.0000Z-5.9000  
N711X53.0000Y356.0000Z-5.9000  
N712X48.0000Y356.0000Z-5.9000  
N713X48.0000Y210.0000Z-5.9000  
N714X43.0000Y210.0000Z-5.9000  
N715X43.0000Y356.0000Z-5.9000  
N716X38.0000Y356.0000Z-5.9000  
N717X38.0000Y210.0000Z-5.9000  
N718X33.0000Y210.0000Z-5.9000  
N719X33.0000Y356.0000Z-5.9000  
N720X28.0000Y356.0000Z-5.9000  
N721X28.0000Y210.0000Z-5.9000  
N722X23.0000Y210.0000Z-5.9000  
N723X23.0000Y356.0000Z-5.9000  
N724X18.0000Y356.0000Z-5.9000  
N725X18.0000Y210.0000Z-5.9000  
N726G0X18.0000Y210.0000Z15.0000  
N727X233.0000Y210.0000Z15.0000  
N728G1X233.0000Y210.0000Z-11.8000  
N729X233.0000Y356.0000Z-11.8000  
N730X228.0000Y356.0000Z-11.8000  
N731X228.0000Y210.0000Z-11.8000  
N732X223.0000Y210.0000Z-11.8000  
N733X223.0000Y356.0000Z-11.8000  
N734X218.0000Y356.0000Z-11.8000  
N735X218.0000Y210.0000Z-11.8000  
N736X213.0000Y210.0000Z-11.8000  
N737X213.0000Y356.0000Z-11.8000  
N738X208.0000Y356.0000Z-11.8000  
N739X208.0000Y210.0000Z-11.8000  
N740X203.0000Y210.0000Z-11.8000  
N741X203.0000Y356.0000Z-11.8000  
N742X198.0000Y356.0000Z-11.8000  
N743X198.0000Y210.0000Z-11.8000  
N744X193.0000Y210.0000Z-11.8000  
N745X193.0000Y356.0000Z-11.8000  
N746X188.0000Y356.0000Z-11.8000  
N747X188.0000Y210.0000Z-11.8000  
N748X183.0000Y210.0000Z-11.8000  
N749X183.0000Y356.0000Z-11.8000  
N750X178.0000Y356.0000Z-11.8000  
N751X178.0000Y210.0000Z-11.8000  
N752X173.0000Y210.0000Z-11.8000  
N753X173.0000Y356.0000Z-11.8000  
N754X168.0000Y356.0000Z-11.8000  
N755X168.0000Y210.0000Z-11.8000  
N756X163.0000Y210.0000Z-11.8000  
N757X163.0000Y356.0000Z-11.8000  
N758X158.0000Y356.0000Z-11.8000  
N759X158.0000Y210.0000Z-11.8000  
N760X153.0000Y210.0000Z-11.8000  
N761X153.0000Y356.0000Z-11.8000  
N762X148.0000Y356.0000Z-11.8000  
N763X148.0000Y210.0000Z-11.8000  
N764X143.0000Y210.0000Z-11.8000  
N765X143.0000Y356.0000Z-11.8000  
N766X138.0000Y356.0000Z-11.8000  
N767X138.0000Y210.0000Z-11.8000  
N768X133.0000Y210.0000Z-11.8000  
N769X133.0000Y356.0000Z-11.8000  
N770X128.0000Y356.0000Z-11.8000  
N771X128.0000Y210.0000Z-11.8000  
N772X123.0000Y210.0000Z-11.8000

N773X123.0000Y356.0000Z-11.8000  
N774X118.0000Y356.0000Z-11.8000  
N775X118.0000Y210.0000Z-11.8000  
N776X113.0000Y210.0000Z-11.8000  
N777X113.0000Y356.0000Z-11.8000  
N778X108.0000Y356.0000Z-11.8000  
N779X108.0000Y210.0000Z-11.8000  
N780X103.0000Y210.0000Z-11.8000  
N781X103.0000Y356.0000Z-11.8000  
N782X98.0000Y356.0000Z-11.8000  
N783X98.0000Y210.0000Z-11.8000  
N784X93.0000Y210.0000Z-11.8000  
N785X93.0000Y356.0000Z-11.8000  
N786X88.0000Y356.0000Z-11.8000  
N787X88.0000Y210.0000Z-11.8000  
N788X83.0000Y210.0000Z-11.8000  
N789X83.0000Y356.0000Z-11.8000  
N790X78.0000Y356.0000Z-11.8000  
N791X78.0000Y210.0000Z-11.8000  
N792X73.0000Y210.0000Z-11.8000  
N793X73.0000Y356.0000Z-11.8000  
N794X68.0000Y356.0000Z-11.8000  
N795X68.0000Y210.0000Z-11.8000  
N796X63.0000Y210.0000Z-11.8000  
N797X63.0000Y356.0000Z-11.8000  
N798X58.0000Y356.0000Z-11.8000  
N799X58.0000Y210.0000Z-11.8000  
N800X53.0000Y210.0000Z-11.8000  
N801X53.0000Y356.0000Z-11.8000  
N802X48.0000Y356.0000Z-11.8000  
N803X48.0000Y210.0000Z-11.8000  
N804X43.0000Y210.0000Z-11.8000  
N805X43.0000Y356.0000Z-11.8000  
N806X38.0000Y356.0000Z-11.8000  
N807X38.0000Y210.0000Z-11.8000  
N808X33.0000Y210.0000Z-11.8000  
N809X33.0000Y356.0000Z-11.8000  
N810X28.0000Y356.0000Z-11.8000  
N811X28.0000Y210.0000Z-11.8000  
N812X23.0000Y210.0000Z-11.8000  
N813X23.0000Y356.0000Z-11.8000  
N814X18.0000Y356.0000Z-11.8000  
N815X18.0000Y210.0000Z-11.8000  
N816G0X18.0000Y210.0000Z15.0000  
N817X233.0000Y210.0000Z15.0000  
N818G1X233.0000Y210.0000Z-17.7000  
N819X233.0000Y356.0000Z-17.7000  
N820X228.0000Y356.0000Z-17.7000  
N821X228.0000Y210.0000Z-17.7000  
N822X223.0000Y210.0000Z-17.7000  
N823X223.0000Y356.0000Z-17.7000  
N824X218.0000Y356.0000Z-17.7000  
N825X218.0000Y210.0000Z-17.7000  
N826X213.0000Y210.0000Z-17.7000  
N827X213.0000Y356.0000Z-17.7000  
N828X208.0000Y356.0000Z-17.7000  
N829X208.0000Y210.0000Z-17.7000  
N830X203.0000Y210.0000Z-17.7000  
N831X203.0000Y356.0000Z-17.7000  
N832X198.0000Y356.0000Z-17.7000  
N833X198.0000Y210.0000Z-17.7000  
N834X193.0000Y210.0000Z-17.7000  
N835X193.0000Y356.0000Z-17.7000  
N836X188.0000Y356.0000Z-17.7000  
N837X188.0000Y210.0000Z-17.7000  
N838X183.0000Y210.0000Z-17.7000  
N839X183.0000Y356.0000Z-17.7000  
N840X178.0000Y356.0000Z-17.7000  
N841X178.0000Y210.0000Z-17.7000  
N842X173.0000Y210.0000Z-17.7000  
N843X173.0000Y356.0000Z-17.7000  
N844X168.0000Y356.0000Z-17.7000  
N845X168.0000Y210.0000Z-17.7000  
N846X163.0000Y210.0000Z-17.7000  
N847X163.0000Y356.0000Z-17.7000  
N848X158.0000Y356.0000Z-17.7000  
N849X158.0000Y210.0000Z-17.7000  
N850X153.0000Y210.0000Z-17.7000  
N851X153.0000Y356.0000Z-17.7000  
N852X148.0000Y356.0000Z-17.7000  
N853X148.0000Y210.0000Z-17.7000  
N854X143.0000Y210.0000Z-17.7000  
N855X143.0000Y356.0000Z-17.7000  
N856X138.0000Y356.0000Z-17.7000  
N857X138.0000Y210.0000Z-17.7000  
N858X133.0000Y210.0000Z-17.7000  
N859X133.0000Y356.0000Z-17.7000  
N860X128.0000Y356.0000Z-17.7000  
N861X128.0000Y210.0000Z-17.7000  
N862X123.0000Y210.0000Z-17.7000  
N863X123.0000Y356.0000Z-17.7000  
N864X118.0000Y356.0000Z-17.7000  
N865X118.0000Y210.0000Z-17.7000  
N866X113.0000Y210.0000Z-17.7000  
N867X113.0000Y356.0000Z-17.7000  
N868X108.0000Y356.0000Z-17.7000  
N869X108.0000Y210.0000Z-17.7000  
N870X103.0000Y210.0000Z-17.7000  
N871X103.0000Y356.0000Z-17.7000  
N872X98.0000Y356.0000Z-17.7000  
N873X98.0000Y210.0000Z-17.7000  
N874X93.0000Y210.0000Z-17.7000  
N875X93.0000Y356.0000Z-17.7000  
N876X88.0000Y356.0000Z-17.7000  
N877X88.0000Y210.0000Z-17.7000  
N878X83.0000Y210.0000Z-17.7000  
N879X83.0000Y356.0000Z-17.7000  
N880X78.0000Y356.0000Z-17.7000  
N881X78.0000Y210.0000Z-17.7000  
N882X73.0000Y210.0000Z-17.7000  
N883X73.0000Y356.0000Z-17.7000  
N884X68.0000Y356.0000Z-17.7000  
N885X68.0000Y210.0000Z-17.7000  
N886X63.0000Y210.0000Z-17.7000  
N887X63.0000Y356.0000Z-17.7000  
N888X58.0000Y356.0000Z-17.7000  
N889X58.0000Y210.0000Z-17.7000  
N890X53.0000Y210.0000Z-17.7000  
N891X53.0000Y356.0000Z-17.7000  
N892X48.0000Y356.0000Z-17.7000  
N893X48.0000Y210.0000Z-17.7000  
N894X43.0000Y210.0000Z-17.7000  
N895X43.0000Y356.0000Z-17.7000  
N896X38.0000Y356.0000Z-17.7000  
N897X38.0000Y210.0000Z-17.7000  
N898X33.0000Y210.0000Z-17.7000  
N899X33.0000Y356.0000Z-17.7000  
N900X28.0000Y356.0000Z-17.7000  
N901X28.0000Y210.0000Z-17.7000  
N902X23.0000Y210.0000Z-17.7000

N903X23.0000Y356.0000Z-17.7000  
N904X18.0000Y356.0000Z-17.7000  
N905X18.0000Y210.0000Z-17.7000  
N906G0X18.0000Y210.0000Z15.0000  
N907X233.0000Y210.0000Z15.0000  
N908G1X233.0000Y210.0000Z-23.6000  
N909X233.0000Y356.0000Z-23.6000  
N910X228.0000Y356.0000Z-23.6000  
N911X228.0000Y210.0000Z-23.6000  
N912X223.0000Y210.0000Z-23.6000  
N913X223.0000Y356.0000Z-23.6000  
N914X218.0000Y356.0000Z-23.6000  
N915X218.0000Y210.0000Z-23.6000  
N916X213.0000Y210.0000Z-23.6000  
N917X213.0000Y356.0000Z-23.6000  
N918X208.0000Y356.0000Z-23.6000  
N919X208.0000Y210.0000Z-23.6000  
N920X203.0000Y210.0000Z-23.6000  
N921X203.0000Y356.0000Z-23.6000  
N922X198.0000Y356.0000Z-23.6000  
N923X198.0000Y210.0000Z-23.6000  
N924X193.0000Y210.0000Z-23.6000  
N925X193.0000Y356.0000Z-23.6000  
N926X188.0000Y356.0000Z-23.6000  
N927X188.0000Y210.0000Z-23.6000  
N928X183.0000Y210.0000Z-23.6000  
N929X183.0000Y356.0000Z-23.6000  
N930X178.0000Y356.0000Z-23.6000  
N931X178.0000Y210.0000Z-23.6000  
N932X173.0000Y210.0000Z-23.6000  
N933X173.0000Y356.0000Z-23.6000  
N934X168.0000Y356.0000Z-23.6000  
N935X168.0000Y210.0000Z-23.6000  
N936X163.0000Y210.0000Z-23.6000  
N937X163.0000Y356.0000Z-23.6000  
N938X158.0000Y356.0000Z-23.6000  
N939X158.0000Y210.0000Z-23.6000  
N940X153.0000Y210.0000Z-23.6000  
N941X153.0000Y356.0000Z-23.6000  
N942X148.0000Y356.0000Z-23.6000  
N943X148.0000Y210.0000Z-23.6000  
N944X143.0000Y210.0000Z-23.6000  
N945X143.0000Y356.0000Z-23.6000  
N946X138.0000Y356.0000Z-23.6000  
N947X138.0000Y210.0000Z-23.6000  
N948X133.0000Y210.0000Z-23.6000  
N949X133.0000Y356.0000Z-23.6000  
N950X128.0000Y356.0000Z-23.6000  
N951X128.0000Y210.0000Z-23.6000  
N952X123.0000Y210.0000Z-23.6000  
N953X123.0000Y356.0000Z-23.6000  
N954X118.0000Y356.0000Z-23.6000  
N955X118.0000Y210.0000Z-23.6000  
N956X113.0000Y210.0000Z-23.6000  
N957X113.0000Y356.0000Z-23.6000  
N958X108.0000Y356.0000Z-23.6000  
N959X108.0000Y210.0000Z-23.6000  
N960X103.0000Y210.0000Z-23.6000  
N961X103.0000Y356.0000Z-23.6000  
N962X98.0000Y356.0000Z-23.6000  
N963X98.0000Y210.0000Z-23.6000  
N964X93.0000Y210.0000Z-23.6000  
N965X93.0000Y356.0000Z-23.6000  
N966X88.0000Y356.0000Z-23.6000  
N967X88.0000Y210.0000Z-23.6000  
N968X83.0000Y210.0000Z-23.6000  
N969X83.0000Y356.0000Z-23.6000  
N970X78.0000Y356.0000Z-23.6000  
N971X78.0000Y210.0000Z-23.6000  
N972X73.0000Y210.0000Z-23.6000  
N973X73.0000Y356.0000Z-23.6000  
N974X68.0000Y356.0000Z-23.6000  
N975X68.0000Y210.0000Z-23.6000  
N976X63.0000Y210.0000Z-23.6000  
N977X63.0000Y356.0000Z-23.6000  
N978X58.0000Y356.0000Z-23.6000  
N979X58.0000Y210.0000Z-23.6000  
N980X53.0000Y210.0000Z-23.6000  
N981X53.0000Y356.0000Z-23.6000  
N982X48.0000Y356.0000Z-23.6000  
N983X48.0000Y210.0000Z-23.6000  
N984X43.0000Y210.0000Z-23.6000  
N985X43.0000Y356.0000Z-23.6000  
N986X38.0000Y356.0000Z-23.6000  
N987X38.0000Y210.0000Z-23.6000  
N988X33.0000Y210.0000Z-23.6000  
N989X33.0000Y356.0000Z-23.6000  
N990X28.0000Y356.0000Z-23.6000  
N991X28.0000Y210.0000Z-23.6000  
N992X23.0000Y210.0000Z-23.6000  
N993X23.0000Y356.0000Z-23.6000  
N994X18.0000Y356.0000Z-23.6000  
N995X18.0000Y210.0000Z-23.6000  
N996G0X18.0000Y210.0000Z15.0000  
N997X233.0000Y210.0000Z15.0000  
N998G1X233.0000Y210.0000Z-29.5000  
N999X233.0000Y356.0000Z-29.5000  
N1000X228.0000Y356.0000Z-29.5000  
N1001X228.0000Y210.0000Z-29.5000  
N1002X223.0000Y210.0000Z-29.5000  
N1003X223.0000Y356.0000Z-29.5000  
N1004X218.0000Y356.0000Z-29.5000  
N1005X218.0000Y210.0000Z-29.5000  
N1006X213.0000Y210.0000Z-29.5000  
N1007X213.0000Y356.0000Z-29.5000  
N1008X208.0000Y356.0000Z-29.5000  
N1009X208.0000Y210.0000Z-29.5000  
N1010X203.0000Y210.0000Z-29.5000  
N1011X203.0000Y356.0000Z-29.5000  
N1012X198.0000Y356.0000Z-29.5000  
N1013X198.0000Y210.0000Z-29.5000  
N1014X193.0000Y210.0000Z-29.5000  
N1015X193.0000Y356.0000Z-29.5000  
N1016X188.0000Y356.0000Z-29.5000  
N1017X188.0000Y210.0000Z-29.5000  
N1018X183.0000Y210.0000Z-29.5000  
N1019X183.0000Y356.0000Z-29.5000  
N1020X178.0000Y356.0000Z-29.5000  
N1021X178.0000Y210.0000Z-29.5000  
N1022X173.0000Y210.0000Z-29.5000  
N1023X173.0000Y356.0000Z-29.5000  
N1024X168.0000Y356.0000Z-29.5000  
N1025X168.0000Y210.0000Z-29.5000  
N1026X163.0000Y210.0000Z-29.5000  
N1027X163.0000Y356.0000Z-29.5000  
N1028X158.0000Y356.0000Z-29.5000  
N1029X158.0000Y210.0000Z-29.5000  
N1030X153.0000Y210.0000Z-29.5000  
N1031X153.0000Y356.0000Z-29.5000  
N1032X148.0000Y356.0000Z-29.5000

N1033X148.0000Y210.0000Z-29.5000  
N1034X143.0000Y210.0000Z-29.5000  
N1035X143.0000Y356.0000Z-29.5000  
N1036X138.0000Y356.0000Z-29.5000  
N1037X138.0000Y210.0000Z-29.5000  
N1038X133.0000Y210.0000Z-29.5000  
N1039X133.0000Y356.0000Z-29.5000  
N1040X128.0000Y356.0000Z-29.5000  
N1041X128.0000Y210.0000Z-29.5000  
N1042X123.0000Y210.0000Z-29.5000  
N1043X123.0000Y356.0000Z-29.5000  
N1044X118.0000Y356.0000Z-29.5000  
N1045X118.0000Y210.0000Z-29.5000  
N1046X113.0000Y210.0000Z-29.5000  
N1047X113.0000Y356.0000Z-29.5000  
N1048X108.0000Y356.0000Z-29.5000  
N1049X108.0000Y210.0000Z-29.5000  
N1050X103.0000Y210.0000Z-29.5000  
N1051X103.0000Y356.0000Z-29.5000  
N1052X98.0000Y356.0000Z-29.5000  
N1053X98.0000Y210.0000Z-29.5000  
N1054X93.0000Y210.0000Z-29.5000  
N1055X93.0000Y356.0000Z-29.5000  
N1056X88.0000Y356.0000Z-29.5000  
N1057X88.0000Y210.0000Z-29.5000  
N1058X83.0000Y210.0000Z-29.5000  
N1059X83.0000Y356.0000Z-29.5000  
N1060X78.0000Y356.0000Z-29.5000  
N1061X78.0000Y210.0000Z-29.5000  
N1062X73.0000Y210.0000Z-29.5000  
N1063X73.0000Y356.0000Z-29.5000  
N1064X68.0000Y356.0000Z-29.5000  
N1065X68.0000Y210.0000Z-29.5000  
N1066X63.0000Y210.0000Z-29.5000  
N1067X63.0000Y356.0000Z-29.5000  
N1068X58.0000Y356.0000Z-29.5000  
N1069X58.0000Y210.0000Z-29.5000  
N1070X53.0000Y210.0000Z-29.5000  
N1071X53.0000Y356.0000Z-29.5000  
N1072X48.0000Y356.0000Z-29.5000  
N1073X48.0000Y210.0000Z-29.5000  
N1074X43.0000Y210.0000Z-29.5000  
N1075X43.0000Y356.0000Z-29.5000  
N1076X38.0000Y356.0000Z-29.5000  
N1077X38.0000Y210.0000Z-29.5000  
N1078X33.0000Y210.0000Z-29.5000  
N1079X33.0000Y356.0000Z-29.5000  
N1080X28.0000Y356.0000Z-29.5000  
N1081X28.0000Y210.0000Z-29.5000  
N1082X23.0000Y210.0000Z-29.5000  
N1083X23.0000Y356.0000Z-29.5000  
N1084X18.0000Y356.0000Z-29.5000  
N1085X18.0000Y210.0000Z-29.5000  
N1086G0X18.0000Y210.0000Z15.0000  
N1087M5  
N1088M9  
N1089G0G49G80G40  
N1090G49Z0.0000  
N1091T1M6  
N1092G43H1Z50.0000  
N1093F230.0000  
N1094G0G49G80G40  
N1095G49Z0.0000  
N1096T2M6  
N1097G43H1Z60.0000  
N1098M8  
N1099M3  
N1100S1200.0000  
N1101X178.2912Y305.9464Z30.0000  
N1102X333.0000Y210.0000Z30.0000  
N1103X333.0000Y210.0000Z15.0000  
N1104G1X333.0000Y210.0000Z-10.0000  
N1105X333.0000Y488.0000Z-10.0000  
N1106X320.0000Y488.0000Z-10.0000  
N1107X320.0000Y210.0000Z-10.0000  
N1108X307.0000Y210.0000Z-10.0000  
N1109X307.0000Y488.0000Z-10.0000  
N1110X294.0000Y488.0000Z-10.0000  
N1111X294.0000Y210.0000Z-10.0000  
N1112X281.0000Y210.0000Z-10.0000  
N1113X281.0000Y488.0000Z-10.0000  
N1114X268.0000Y488.0000Z-10.0000  
N1115X268.0000Y210.0000Z-10.0000  
N1116X255.0000Y210.0000Z-10.0000  
N1117X255.0000Y488.0000Z-10.0000  
N1118X242.0000Y488.0000Z-10.0000  
N1119X242.0000Y210.0000Z-10.0000  
N1120X229.0000Y210.0000Z-10.0000  
N1121X229.0000Y488.0000Z-10.0000  
N1122X216.0000Y488.0000Z-10.0000  
N1123X216.0000Y210.0000Z-10.0000  
N1124X203.0000Y210.0000Z-10.0000  
N1125X203.0000Y488.0000Z-10.0000  
N1126X190.0000Y488.0000Z-10.0000  
N1127X190.0000Y210.0000Z-10.0000  
N1128X177.0000Y210.0000Z-10.0000  
N1129X177.0000Y488.0000Z-10.0000  
N1130X164.0000Y488.0000Z-10.0000  
N1131X164.0000Y210.0000Z-10.0000  
N1132X151.0000Y210.0000Z-10.0000  
N1133X151.0000Y488.0000Z-10.0000  
N1134X138.0000Y488.0000Z-10.0000  
N1135X138.0000Y210.0000Z-10.0000  
N1136X125.0000Y210.0000Z-10.0000  
N1137X125.0000Y488.0000Z-10.0000  
N1138X112.0000Y488.0000Z-10.0000  
N1139X112.0000Y210.0000Z-10.0000  
N1140X99.0000Y210.0000Z-10.0000  
N1141X99.0000Y488.0000Z-10.0000  
N1142X86.0000Y488.0000Z-10.0000  
N1143X86.0000Y210.0000Z-10.0000  
N1144X73.0000Y210.0000Z-10.0000  
N1145X73.0000Y488.0000Z-10.0000  
N1146X60.0000Y488.0000Z-10.0000  
N1147X60.0000Y210.0000Z-10.0000  
N1148X47.0000Y210.0000Z-10.0000  
N1149X47.0000Y488.0000Z-10.0000  
N1150X34.0000Y488.0000Z-10.0000  
N1151X34.0000Y210.0000Z-10.0000  
N1152X21.0000Y210.0000Z-10.0000  
N1153X21.0000Y488.0000Z-10.0000  
N1154X8.0000Y488.0000Z-10.0000  
N1155X8.0000Y210.0000Z-10.0000  
N1156G0X8.0000Y210.0000Z15.0000  
N1157X333.0000Y210.0000Z15.0000  
N1158G1X333.0000Y210.0000Z-20.0000  
N1159X333.0000Y488.0000Z-20.0000  
N1160X320.0000Y488.0000Z-20.0000  
N1161X320.0000Y210.0000Z-20.0000  
N1162X307.0000Y210.0000Z-20.0000

N1163X307.0000Y488.0000Z-20.0000  
N1164X294.0000Y488.0000Z-20.0000  
N1165X294.0000Y210.0000Z-20.0000  
N1166X281.0000Y210.0000Z-20.0000  
N1167X281.0000Y488.0000Z-20.0000  
N1168X268.0000Y488.0000Z-20.0000  
N1169X268.0000Y210.0000Z-20.0000  
N1170X255.0000Y210.0000Z-20.0000  
N1171X255.0000Y488.0000Z-20.0000  
N1172X242.0000Y488.0000Z-20.0000  
N1173X242.0000Y210.0000Z-20.0000  
N1174X229.0000Y210.0000Z-20.0000  
N1175X229.0000Y488.0000Z-20.0000  
N1176X216.0000Y488.0000Z-20.0000  
N1177X216.0000Y210.0000Z-20.0000  
N1178X203.0000Y210.0000Z-20.0000  
N1179X203.0000Y488.0000Z-20.0000  
N1180X190.0000Y488.0000Z-20.0000  
N1181X190.0000Y210.0000Z-20.0000  
N1182X177.0000Y210.0000Z-20.0000  
N1183X177.0000Y488.0000Z-20.0000  
N1184X164.0000Y488.0000Z-20.0000  
N1185X164.0000Y210.0000Z-20.0000  
N1186X151.0000Y210.0000Z-20.0000  
N1187X151.0000Y488.0000Z-20.0000  
N1188X138.0000Y488.0000Z-20.0000  
N1189X138.0000Y210.0000Z-20.0000  
N1190X125.0000Y210.0000Z-20.0000  
N1191X125.0000Y488.0000Z-20.0000  
N1192X112.0000Y488.0000Z-20.0000  
N1193X112.0000Y210.0000Z-20.0000  
N1194X99.0000Y210.0000Z-20.0000  
N1195X99.0000Y488.0000Z-20.0000  
N1196X86.0000Y488.0000Z-20.0000  
N1197X86.0000Y210.0000Z-20.0000  
N1198X73.0000Y210.0000Z-20.0000  
N1199X73.0000Y488.0000Z-20.0000  
N1200X60.0000Y488.0000Z-20.0000  
N1201X60.0000Y210.0000Z-20.0000  
N1202X47.0000Y210.0000Z-20.0000  
N1203X47.0000Y488.0000Z-20.0000  
N1204X34.0000Y488.0000Z-20.0000  
N1205X34.0000Y210.0000Z-20.0000  
N1206X21.0000Y210.0000Z-20.0000  
N1207X21.0000Y488.0000Z-20.0000  
N1208X8.0000Y488.0000Z-20.0000  
N1209X8.0000Y210.0000Z-20.0000  
N1210G0X8.0000Y210.0000Z15.0000  
N1211X333.0000Y210.0000Z15.0000  
N1212G1X333.0000Y210.0000Z-30.0000  
N1213X333.0000Y488.0000Z-30.0000  
N1214X320.0000Y488.0000Z-30.0000  
N1215X320.0000Y210.0000Z-30.0000  
N1216X307.0000Y210.0000Z-30.0000  
N1217X307.0000Y488.0000Z-30.0000  
N1218X294.0000Y488.0000Z-30.0000  
N1219X294.0000Y210.0000Z-30.0000  
N1220X281.0000Y210.0000Z-30.0000  
N1221X281.0000Y488.0000Z-30.0000  
N1222X268.0000Y488.0000Z-30.0000  
N1223X268.0000Y210.0000Z-30.0000  
N1224X255.0000Y210.0000Z-30.0000  
N1225X255.0000Y488.0000Z-30.0000  
N1226X242.0000Y488.0000Z-30.0000  
N1227X242.0000Y210.0000Z-30.0000  
N1228X229.0000Y210.0000Z-30.0000  
N1229X229.0000Y488.0000Z-30.0000  
N1230X216.0000Y488.0000Z-30.0000  
N1231X216.0000Y210.0000Z-30.0000  
N1232X203.0000Y210.0000Z-30.0000  
N1233X203.0000Y488.0000Z-30.0000  
N1234X190.0000Y488.0000Z-30.0000  
N1235X190.0000Y210.0000Z-30.0000  
N1236X177.0000Y210.0000Z-30.0000  
N1237X177.0000Y488.0000Z-30.0000  
N1238X164.0000Y488.0000Z-30.0000  
N1239X164.0000Y210.0000Z-30.0000  
N1240X151.0000Y210.0000Z-30.0000  
N1241X151.0000Y488.0000Z-30.0000  
N1242X138.0000Y488.0000Z-30.0000  
N1243X138.0000Y210.0000Z-30.0000  
N1244X125.0000Y210.0000Z-30.0000  
N1245X125.0000Y488.0000Z-30.0000  
N1246X112.0000Y488.0000Z-30.0000  
N1247X112.0000Y210.0000Z-30.0000  
N1248X99.0000Y210.0000Z-30.0000  
N1249X99.0000Y488.0000Z-30.0000  
N1250X86.0000Y488.0000Z-30.0000  
N1251X86.0000Y210.0000Z-30.0000  
N1252X73.0000Y210.0000Z-30.0000  
N1253X73.0000Y488.0000Z-30.0000  
N1254X60.0000Y488.0000Z-30.0000  
N1255X60.0000Y210.0000Z-30.0000  
N1256X47.0000Y210.0000Z-30.0000  
N1257X47.0000Y488.0000Z-30.0000  
N1258X34.0000Y488.0000Z-30.0000  
N1259X34.0000Y210.0000Z-30.0000  
N1260X21.0000Y210.0000Z-30.0000  
N1261X21.0000Y488.0000Z-30.0000  
N1262X8.0000Y488.0000Z-30.0000  
N1263X8.0000Y210.0000Z-30.0000  
N1264G0X8.0000Y210.0000Z15.0000  
N1265M5  
N1266M9  
N1267G0G49G80G40  
N1268G49Z0.0000  
N1269T3M6  
N1270G43H1Z50.0000  
N1271M8  
N1272M3  
N1273S1200.0000  
N1274X8.0000Y210.0000Z0.0000  
N1275X68.0000Y282.0000Z0.0000  
N1276X68.0000Y282.0000Z-15.0000  
N1277G1X68.0000Y282.0000Z-36.5000  
N1278X68.0000Y282.0000Z-36.5000  
N1279X166.0000Y282.0000Z-36.5000  
N1280G0X68.0000Y282.0000Z-30.0000  
N1281G1X68.0000Y282.0000Z-43.0000  
N1282X166.0000Y282.0000Z-43.0000  
N1283G0X68.0000Y282.0000Z-36.5000  
N1284G1X68.0000Y282.0000Z-49.5000  
N1285X166.0000Y282.0000Z-49.5000  
N1286G0X68.0000Y282.0000Z-43.0000  
N1287M5  
N1288M9  
N1289G0G49G80G40  
N1290G49Z0.0000  
N1291T1M6  
N1292G43H1Z50.0000

N1293F230.0000  
N1294G0G49G80G40  
N1295G49Z0.0000  
N1296T4M6  
N1297G43H1Z60.0000  
N1298M8  
N1299M3  
N1300S1200.0000  
N1301X125.1079Y273.0000Z0.0000  
N1302X69.0000Y283.0000Z0.0000  
N1303X69.0000Y283.0000Z-15.0000  
N1304G1X69.0000Y283.0000Z-40.0000  
N1305X69.0000Y283.0000Z-40.0000  
N1306X169.0000Y283.0000Z-40.0000  
N1307G0X69.0000Y283.0000Z-30.0000  
N1308G1X69.0000Y283.0000Z-50.0000  
N1309X169.0000Y283.0000Z-50.0000  
N1310G0X69.0000Y283.0000Z-40.0000  
N1311M5  
N1312M9  
N1313G0G49G80G40  
N1314G49Z0.0000  
N1315T5M6  
N1316G43H1Z70.0000  
N1317M8  
N1318M3  
N1319S960.0000  
N1320F1800.0000  
N1321X69.0000Y283.0000Z0.0000  
N1322X25.0000Y308.0000Z0.0000  
N1323X25.0000Y308.0000Z-20.0000  
N1324F900.0000  
N1325G1X25.0000Y308.0000Z-37.9361  
N1326F1800.0000  
N1327X25.0000Y308.0000Z-43.9361  
N1328F1350.0000  
N1329X25.0000Y308.0000Z-65.9361  
N1330F1800.0000  
N1331X25.0000Y308.0000Z-20.0000  
N1332M5  
N1333M9  
N1334G0G49G80G40  
N1335G49Z0.0000  
N1336T1M6  
N1337G43H1Z50.0000  
N1338F230.0000  
N1339G0G49G80G40  
N1340G49Z0.0000  
N1341T5M6  
N1342G43H1Z70.0000  
N1343M8  
N1344M3  
N1345S960.0000  
N1346G0X17.3177Y310.2319Z0.0000  
N1347X193.0000Y308.0000Z0.0000  
N1348X193.0000Y308.0000Z-20.0000  
N1349F900.0000  
N1350G1X193.0000Y308.0000Z-37.9361  
N1351F1800.0000  
N1352X193.0000Y308.0000Z-43.9361  
N1353F1350.0000  
N1354X193.0000Y308.0000Z-65.9361  
N1355F1800.0000  
N1356X193.0000Y308.0000Z-20.0000  
N1357M5  
N1358M9  
N1359G0G49G80G40  
N1360G49Z0.0000  
N1361T1M6  
N1362G43H1Z50.0000  
N1363F230.0000  
N1364G0G49G80G40  
N1365G49Z0.0000  
N1366T5M6  
N1367G43H1Z70.0000  
N1368M8  
N1369M3  
N1370S960.0000  
N1371G0X187.9981Y314.2434Z0.0000  
N1372X25.0000Y258.0000Z0.0000  
N1373X25.0000Y258.0000Z-20.0000  
N1374F900.0000  
N1375G1X25.0000Y258.0000Z-37.9361  
N1376F1800.0000  
N1377X25.0000Y258.0000Z-43.9361  
N1378F1350.0000  
N1379X25.0000Y258.0000Z-65.9361  
N1380F1800.0000  
N1381X25.0000Y258.0000Z-20.0000  
N1382M5  
N1383M9  
N1384G0G49G80G40  
N1385G49Z0.0000  
N1386T1M6  
N1387G43H1Z50.0000  
N1388F230.0000  
N1389G0G49G80G40  
N1390G49Z0.0000  
N1391T5M6  
N1392G43H1Z70.0000  
N1393M8  
N1394M3  
N1395S960.0000  
N1396G0X24.6231Y265.9911Z0.0000  
N1397X193.0000Y258.0000Z0.0000  
N1398X193.0000Y258.0000Z-20.0000  
N1399F900.0000  
N1400G1X193.0000Y258.0000Z-37.9361  
N1401F1800.0000  
N1402X193.0000Y258.0000Z-43.9361  
N1403F1350.0000  
N1404X193.0000Y258.0000Z-65.9361  
N1405F1800.0000  
N1406X193.0000Y258.0000Z-20.0000  
N1407M5  
N1408M9  
N1409G0G49G80G40  
N1410G49Z0.0000  
N1411T1M6  
N1412G43H1Z50.0000  
N1413F230.0000  
N1414M99



## Appendix C.3 Newly Generated STEP Part 21 File

```

ISO-10303-21;
HEADER;
/* Generated by software containing ST-Developer
 * from STEP Tools, Inc. (www.steptools.com)
 */
FILE_DESCRIPTION(
/* description */ ('ISO 14649-11 EXAMPLE 1',
' Workpiece with Two5D machining features '),
/* implementation_level */ '2;1');
FILE_NAME(
/* name */ 'EXAMPLE1.STP',
/* time_stamp */ '2009-11-11T18:43:02+13:00',
/* author */ ('Fiona Zhao','Xun Xu'),
/* organization */ ('University of Auckland'),
/* preprocessor_version */ 'ST-DEVELOPER v12',
/* originating_system */ 'Fish-head roughing example',
/* authorisation */ $);
FILE_SCHEMA (('MACHINING_SCHEMA','MILLING_SCHEMA'));
ENDSEC;
DATA;
#10=DM_WORKINGSTEP('setup inspection top surface',#205,#25,$,$,$,#50,
#30);
#11=DM_WORKINGSTEP('setup inspection leftside surface',#205,#26,$,$,$,
#51,#31);
#12=DM_WORKINGSTEP('setup inspection front surface',#205,#27,$,$,$,#52,
#32);
#13=DM_WORKINGSTEP('setup inspection rightside surface',#205,#28,$,$,$,
#53,#33);
#14=DM_WORKINGSTEP('setup inspection back surface',#205,#29,$,$,$,#54,
#34);
#15=DM_WORKINGSTEP('RIGHT POCKET ROUGHING',#205,#29,(#148),$,$,#56,#36);
#16=DM_WORKINGSTEP('RIGHT POCKET ROUGHING',#205,#29,(#149),$,$,#56,#36);
#17=DM_WORKINGSTEP('SQUARE OPEN POCKET ROUGHING',#205,#29,(#403),$,$,#58,
#38);
#18=DM_WORKINGSTEP('DIAGONAL OPEN POCKET ROUGHING',#205,#29,(#229),$,$,
#60,#40);
#19=DM_WORKINGSTEP('STEP ROUGHING',#205,#29,(#104),$,$,#62,#42);
#20=DM_WORKINGSTEP('SLOT ROUGH MILLING',#205,#29,(#95),$,$,#64,#44);
#21=DM_WORKINGSTEP('HOLE DRILLING',#205,#29,(#150),$,$,#66,#46);
#22=DM_WORKINGSTEP('HOLE DRILLING',#205,#29,(#151),$,$,#67,#47);
#23=DM_WORKINGSTEP('HOLE DRILLING',#205,#29,(#152),$,$,#68,#48);
#24=DM_WORKINGSTEP('HOLE DRILLING',#205,#29,(#153),$,$,#69,#49);
#25=DM_FEATURE_PLANE('setup inspection top surface',#203,$,(#50),$,$);
#26=DM_FEATURE_PLANE('setup inspection leftside surface',#203,$,(#51),$,
$);
#27=DM_FEATURE_PLANE('setup inspection front surface',#203,$,(#52),$,$);
#28=DM_FEATURE_PLANE('setup inspection rightside surface',#203,$,(#53),$,
$);
#29=DM_FEATURE_PLANE('setup inspection back surface',#203,$,(#54),$,$);
#30=DM_RESULT($,$,$,$);
#31=DM_RESULT($,$,$,$);
#32=DM_RESULT($,$,$,$);
#33=DM_RESULT($,$,$,$);
#34=DM_RESULT($,$,$,$);
#35=DM_RESULT($,$,$,$);

```

```

#36=DM_RESULT($,$,$,$);
#37=DM_RESULT($,$,$,$);
#38=DM_RESULT($,$,$,$);
#39=DM_RESULT($,$,$,$);
#40=DM_RESULT($,$,$,$);
#41=DM_RESULT($,$,$,$);
#42=DM_RESULT($,$,$,$);
#43=DM_RESULT($,$,$,$);
#44=DM_RESULT($,$,$,$);
#45=DM_RESULT($,$,$,$);
#46=DM_RESULT($,$,$,$);
#47=DM_RESULT($,$,$,$);
#48=DM_RESULT($,$,$,$);
#49=DM_RESULT($,$,$,$);
#50=PROBING_OPERATION($,$,'setup inspection top surface',0.,$, #73,#72,
    #70,$,$,#71);
#51=PROBING_OPERATION($,$,'setup inspection leftside surface',0.,$, #73,
    #72,#70,$,$,#71);
#52=PROBING_OPERATION($,$,'setup inspection front surface',0.,$, #73,#72,
    #70,$,$,#71);
#53=PROBING_OPERATION($,$,'setup inspection rightside surface',0.,$, #73,
    #72,#70,$,$,#71);
#54=PROBING_OPERATION($,$,'setup inspection back surface',0.,$, #73,
    #72,#70,$,$,#71);
#55=PROBING_OPERATION($,$,'LEFT POCKET ROUGHING',0.,$, #73,#72,#70,$,$,
    #71);
#56=PROBING_OPERATION($,$,'RIGHT POCKET ROUGHING',0.,$, #73,#72,#70,$,$,
    #71);
#57=PROBING_OPERATION($,$,'RIGHT POCKET FINISHING',0.,$, #73,#72,#70,$,$,
    #71);
#58=PROBING_OPERATION($,$,'SQUARE OPEN POCKET ROUGHING',0.,$, #73,#72,#70,
    $,$,#71);
#59=PROBING_OPERATION($,$,'SQUARE OPEN POCKET FINISHING',0.,$, #73,#72,
    #70,$,$,#71);
#60=PROBING_OPERATION($,$,'DIAGONAL OPEN POCKET ROUGHING',0.,$, #73,#72,
    #70,$,$,#71);
#61=PROBING_OPERATION($,$,'DIAGONAL OPEN POCKET FINISHING',0.,$, #73,#72,
    #70,$,$,#71);
#62=PROBING_OPERATION($,$,'STEP ROUGHING',0.,$, #73,#72,#70,$,$,#71);
#63=PROBING_OPERATION($,$,'STEP FINISHING',0.,$, #73,#72,#70,$,$,#71);
#64=PROBING_OPERATION($,$,'SLOT ROUGH MILLING',0.,$, #73,#72,#70,$,$,#71);
#65=PROBING_OPERATION($,$,'SLOT FINISH MILLING',0.,$, #73,#72,#70,$,$,#71)
;
#66=PROBING_OPERATION($,$,'HOLE DRILLING',0.,$, #73,#72,#70,$,$,#71);
#67=PROBING_OPERATION($,$,'HOLE DRILLING',0.,$, #73,#72,#70,$,$,#71);
#68=PROBING_OPERATION($,$,'HOLE DRILLING',0.,$, #73,#72,#70,$,$,#71);
#69=PROBING_OPERATION($,$,'HOLE DRILLING',0.,$, #73,#72,#70,$,$,#71);
#70=TOUCH_PROBE('PROBE NUM01',$,#224,#222,(#220));
#71=TOUCH_PROBING_STRATEGY($,$);
#72=OMM_COORD_MET_FUNCTIONS($,$,$,.T.);
#73=OMM_COORD_MET_TECHNOLOGY(230.,.TCP.,$,0.);
#74=NUMERIC_PARAMETER('PROFILE LENGTH',218.,'MM');
#75=LINEAR_PROFILE($,#74);
#76=PLANE_FINISH_MILLING($,$,'FINISH TOP SURFACE',10.,$, #170,#178,#174,$,
    #102,#103,#78,2.5,$);
#77=PLANAR_FACE('TOP SURFACE',#203,(#76),#391,(),#217,#101,#75,$,());
#78=BIDIRECTIONAL_MILLING(0.05,.T.,#303,.LEFT.,$);
#79=TWIST_DRILL(#162,2,.RIGHT.,.F.,0.84);

```

```

#80=THROUGH_BOTTOM_CONDITION();
#81=DRILLING($,$,'DRILL HOLE1',10.,$, #169,#179,#175,$,$,$,$,$,#143);
#82=DRILLING($,$,'DRILL HOLE2',10.,$, #169,#179,#175,$,$,$,$,$,#143);
#83=DRILLING($,$,'DRILL HOLE3',10.,$, #169,#179,#175,$,$,$,$,$,#143);
#84=DRILLING($,$,'DRILL HOLE4',10.,$, #169,#179,#175,$,$,$,$,$,#143);
#85=TOLERANCED_CYLINDER('POSITION TOLERANCED CYLINDER HOLE1',#383,#213,
    16.);
#86=TOLERANCED_CYLINDER('POSITION TOLERANCED CYLINDER HOLE2',#385,#214,
    16.);
#87=TOLERANCED_CYLINDER('POSITION TOLERANCED CYLINDER HOLE3',#387,#215,
    16.);
#88=TOLERANCED_CYLINDER('POSITION TOLERANCED CYLINDER HOLE4',#389,#216,
    16.);
#89=ROUND_HOLE('HOLE1',#203,(#81),#383,(#150),#213,#139,$,#80);
#90=ROUND_HOLE('HOLE1',#203,(#82),#385,(#151),#214,#139,$,#80);
#91=ROUND_HOLE('HOLE3',#203,(#83),#387,(#152),#215,#139,$,#80);
#92=ROUND_HOLE('HOLE3',#203,(#84),#389,(#153),#216,#139,$,#80);
#93=BOSS('POCKET-BOSS',#203,(),#381,(),#212,#108,$);
#94=UNIDIRECTIONAL_MILLING($,.T.,#290,$);
#95=PERPENDICULARITY_TOLERANCE('PERPENDICULARITY TOLERANCE ON SLOT',
    (#401,#402),#98,$,$,$,$,0.02,$,(#236),$);
#96=RADIUSED_SLOT_END_TYPE();
#97=SQUARE_U_PROFILE($,#135,#136,0.,#136,0.);
#98=SLOT('SLOT',#203,(#145,#184),#377,(#95),#211,#100,#97,(#96,#96));
#99=LINEAR_PATH($,#133,#280);
#100=LINEAR_PATH($,#134,#285);
#101=LINEAR_PATH($,#140,#306);
#102=PLUNGE_TOOLAXIS($);
#103=PLUNGE_TOOLAXIS($);
#104=PARALLELISM_TOLERANCE('PARALLELISM TOLERANCE ON STEP',(#400),#105,$,
    $,$,$,0.02,$,(#236),$);
#105=STEP('STEP FEATURE',#203,(#147,#183),#375,(#104),#210,#99,$,());
#106=RECTANGULAR_CLOSED_PROFILE($,#126,#127);
#107=RECTANGULAR_CLOSED_PROFILE($,#128,#129);
#108=RECTANGULAR_CLOSED_PROFILE($,#137,#138);
#109=PLUS_MINUS_VALUE(0.1,0.1,3);
#110=PLUS_MINUS_VALUE(0.1,0.1,3);
#111=PLUS_MINUS_VALUE(0.1,0.1,3);
#112=PLUS_MINUS_VALUE(0.1,0.1,3);
#113=PLUS_MINUS_VALUE(0.1,0.1,3);
#114=PLUS_MINUS_VALUE(0.1,0.1,3);
#115=PLUS_MINUS_VALUE(0.1,0.1,3);
#116=PLUS_MINUS_VALUE(0.1,0.1,3);
#117=PLUS_MINUS_VALUE(0.1,0.1,3);
#118=PLUS_MINUS_VALUE(0.1,0.1,3);
#119=PLUS_MINUS_VALUE(0.1,0.1,3);
#120=PLUS_MINUS_VALUE(0.1,0.1,3);
#121=PLUS_MINUS_VALUE(0.3,0.3,3);
#122=PLUS_MINUS_VALUE(0.3,0.3,3);
#123=PLUS_MINUS_VALUE(0.1,0.1,3);
#124=PLUS_MINUS_VALUE(0.3,0.3,3);
#125=TOLERANCED_LENGTH_MEASURE(10.,#109);
#126=TOLERANCED_LENGTH_MEASURE(64.,#114);
#127=TOLERANCED_LENGTH_MEASURE(87.,#115);
#128=TOLERANCED_LENGTH_MEASURE(80.,#116);
#129=TOLERANCED_LENGTH_MEASURE(87.,#117);
#130=TOLERANCED_LENGTH_MEASURE(9.,#118);
#131=TOLERANCED_LENGTH_MEASURE(10.,#119);

```

```

#132=TOLERANCED_LENGTH_MEASURE (20., #120);
#133=TOLERANCED_LENGTH_MEASURE (215., #121);
#134=TOLERANCED_LENGTH_MEASURE (100., #122);
#135=TOLERANCED_LENGTH_MEASURE (20., #122);
#136=TOLERANCED_LENGTH_MEASURE (0.1, #122);
#137=TOLERANCED_LENGTH_MEASURE (30., #122);
#138=TOLERANCED_LENGTH_MEASURE (37., #122);
#139=TOLERANCED_LENGTH_MEASURE (16., #123);
#140=TOLERANCED_LENGTH_MEASURE (326., #124);
#141=PLANAR_POCKET_BOTTOM_CONDITION ();
#142=DRILLING_TYPE_STRATEGY ($, $, $, $, $, $);
#143=DRILLING_TYPE_STRATEGY (0.75, 0.5, 2., 0.5, 0.75, 8.);
#144=BOTTOM_AND_SIDE_ROUGH_MILLING ($, $, 'ROUGHING POCKET', 15., $, #168, #178,
    #174, $, #103, $, #172, 9., 9., 1., 0.5);
#145=BOTTOM_AND_SIDE_ROUGH_MILLING ($, $, 'SLOT ROUGHING', 15., $, #168, #178,
    #174, $, #103, $, #94, 6.5, 5., 1., 0.5);
#146=BOTTOM_AND_SIDE_ROUGH_MILLING ($, $, 'ROUGH DIAGONAL POCKET', 15., $,
    #170, #178, #174, $, #103, $, #172, 6.5, 5., 1., 0.5);
#147=BOTTOM_AND_SIDE_ROUGH_MILLING ($, $, 'ROUGH STEP', 15., $, #170, #180, #176,
    $, #103, $, #78, 6.5, 5., 1., 0.5);
#148=POSITION_TOLERANCE ('POSITION TOLERANCE ON BOSS', (#396, #397), #155, $,
    $, $, $, 0.1, $, $, $);
#149=POSITION_TOLERANCE ('POSITION TOLERANCE ON BOSS', (#398, #399), #155, $,
    $, $, $, 0.2, $, $, $);
#150=POSITION_TOLERANCE ('POSITION TOLERANCE ON HOLE1', (#85), #89, $, $, $, $,
    0.05, $, (#237), $);
#151=POSITION_TOLERANCE ('POSITION TOLERANCE ON HOLE2', (#86), #90, $, $, $, $,
    0.05, $, (#237), $);
#152=POSITION_TOLERANCE ('POSITION TOLERANCE ON HOLE3', (#87), #91, $, $, $, $,
    0.05, $, (#237), $);
#153=POSITION_TOLERANCE ('POSITION TOLERANCE ON HOLE4', (#88), #92, $, $, $, $,
    0.05, $, (#237), $);
#154=CLOSED_POCKET ('POCKET3', #203, (#144), #362, $, #206, $, $, #141, $, #125,
    #106);
#155=CLOSED_POCKET ('POCKET4', #203, (#144, #181), #364, (#148, #149), #207, (#93)
    $, #141, $, #125, #107);
#156=CUTTING_COMPONENT (60., $, $, $, $);
#157=CUTTING_COMPONENT (50., $, $, $, $);
#158=CUTTING_COMPONENT (70., $, $, $, $);
#159=CUTTING_COMPONENT (60., $, $, $, $);
#160=MILLING_TOOL_DIMENSION (20., $, $, 29., 0., $, $);
#161=MILLING_TOOL_DIMENSION (18., $, $, 29., 0., $, $);
#162=MILLING_TOOL_DIMENSION (16., 31., 0.1, 70., 2., 5., 8.);
#163=MILLING_TOOL_DIMENSION (40., $, $, 29., 0., $, $);
#164=TAPERED_ENDMILL (#160, 4, .RIGHT., .F., $, $);
#165=TAPERED_ENDMILL (#161, 4, .RIGHT., .F., $, $);
#166=TAPERED_ENDMILL (#163, 4, .RIGHT., .F., $, $);
#167=MILLING_CUTTING_TOOL ('MILL 20MM', #164, (#156), 80., $, $);
#168=MILLING_CUTTING_TOOL ('MILL 18MM', #165, (#157), 80., $, $);
#169=MILLING_CUTTING_TOOL ('SPIRAL_DRILL_16MM', #79, (#158), 90., $, $);
#170=MILLING_CUTTING_TOOL ('MILL 40MM', #166, (#159), 80., $, $);
#171=CONTOUR_PARALLEL (0.05, .T., .CW., .CONVENTIONAL.);
#172=CONTOUR_PARALLEL ($, $, .CW., .CONVENTIONAL.);
#173=MILLING_MACHINE_FUNCTIONS (.T., $, $, .F., $, $, $, $, $, $, $, $, $, $, $, $, $, $, $, $);
#174=MILLING_MACHINE_FUNCTIONS (.T., $, $, .F., $, $, $, $, $, $, $, $, $, $, $, $, $, $, $, $);
#175=MILLING_MACHINE_FUNCTIONS (.T., $, $, .F., $, $, $, $, $, $, $, $, $, $, $, $, $, $, $, $);
#176=MILLING_MACHINE_FUNCTIONS (.T., $, $, .F., $, $, $, $, $, $, $, $, $, $, $, $, $, $, $, $);
#177=MILLING_TECHNOLOGY (0.04, .TCP., $, -20., $, .F., .F., .F., $);

```

```

#178=MILLING_TECHNOLOGY(0.04,.TCP.,$, -20.,$, .F.,.F.,.F.,$);
#179=MILLING_TECHNOLOGY(0.03,.TCP.,$, -16.,$, .F.,.F.,.F.,$);
#180=MILLING_TECHNOLOGY(0.04,.TCP.,$, -12.,$, .F.,.F.,.F.,$);
#181=BOTTOM_AND_SIDE_FINISH_MILLING($,$,'FINISHING POCKET',15.,$, #168,
    #177,#173,$,#103,$,#171,12.,13.,$, $);
#182=BOTTOM_AND_SIDE_FINISH_MILLING($,$,'FINISHING DIAGONAL POCKET',15.,
    $,#170,#177,#173,$,#103,$,#171,2.,10.,$, $);
#183=BOTTOM_AND_SIDE_FINISH_MILLING($,$,'FINISHING STEP',15.,$, #170,#177,
    #173,$,#103,$,#78,12.,13.,$, $);
#184=BOTTOM_AND_SIDE_FINISH_MILLING($,$,'SLOT FINISHING',15.,$, #167,#177,
    #173,$,#103,$,#94,12.,13.,$, $);
#185=MACHINING_WORKINGSTEP('LEFT POCKET ROUGHING',#205,#154,#144,$);
#186=MACHINING_WORKINGSTEP('RIGHT POCKET ROUGHING',#205,#155,#144,$);
#187=MACHINING_WORKINGSTEP('SQUARE OPEN POCKET ROUGHING',#205,#404,#144,
    $);
#188=MACHINING_WORKINGSTEP('DIAGONAL OPEN POCKET ROUGHING',#205,#405,
    #146,$);
#189=MACHINING_WORKINGSTEP('RIGHT POCKET FINISHING',#205,#155,#181,$);
#190=MACHINING_WORKINGSTEP('SQUARE OPEN POCKET FINISHING',#205,#404,#181,
    $);
#191=MACHINING_WORKINGSTEP('DIAGONAL OPEN POCKET FINISHING',#205,#405,
    #182,$);
#192=MACHINING_WORKINGSTEP('STEP FINISHING',#205,#105,#183,$);
#193=MACHINING_WORKINGSTEP('SLOT FINISH MILLING',#205,#98,#184,$);
#194=MACHINING_WORKINGSTEP('STEP ROUGHING',#205,#105,#147,$);
#195=MACHINING_WORKINGSTEP('SLOT ROUGH MILLING',#205,#98,#145,$);
#196=MACHINING_WORKINGSTEP('HOLE DRILLING',#205,#89,#81,$);
#197=MACHINING_WORKINGSTEP('HOLE DRILLING',#205,#90,#82,$);
#198=MACHINING_WORKINGSTEP('HOLE DRILLING',#205,#91,#83,$);
#199=MACHINING_WORKINGSTEP('HOLE DRILLING',#205,#92,#84,$);
#200=MACHINING_WORKINGSTEP('TOP SURFACE FINISH MILLING',#205,#77,#76,$);
#201=MATERIAL('ST-50','STEEL',(#202));
#202=PROPERTY_PARAMETER('E=200000N/M2');
#203=WORKPIECE('SIMPLE WORKPIECE',#201,0.01,$,$,$, (#312,#313,#314,#315));
#204=WORKPIECE_SETUP(#203,#361,$,$, ());
#205=PLANE('SECURITY PLANE',#360);
#206=PLANE('DEPTH SURFACE FOR POCKET3',#363);
#207=PLANE('DEPTH SURFACE FOR POCKET4',#365);
#208=PLANE('DEPTH SURFACE FOR SQUARE OPEN POCKET',#367);
#209=PLANE('DEPTH SURFACE FOR DIAGONAL OPEN POCKET',#369);
#210=PLANE('DEPTH SURFACE FOR STEP',#376);
#211=PLANE('DEPTH SURFACE FOR SLOT',#378);
#212=PLANE('DEPTH SURFACE FOR BOSS',#382);
#213=PLANE('DEPTH SURFACE FOR ROUND HOLE1',#384);
#214=PLANE('DEPTH SURFACE FOR ROUND HOLE2',#386);
#215=PLANE('DEPTH SURFACE FOR ROUND HOLE3',#388);
#216=PLANE('DEPTH SURFACE FOR ROUND HOLE4',#390);
#217=PLANE('TOP SURFACE-DEPTH PLANE',#392);
#218=SETUP('SETUP1',#359,#205, (#204));
#219=WORKPLAN('MAIN WORKPLAN', (#200,#10,#11,#12,#13,#14,#185,#186,#16,
    #15,#189,#187,#17,#190,#188,#18,#191,#194,#19,#192,#195,#20,#193,
    #196,#21,#197,#22,#198,#23,#199,#24), $, #218,$);
#220=STYLUS_DIMENSION($,50.,6.,6.,$, $);
#221=STYLUS_DIMENSION($,50.,6.,6.,$, $);
#222=BODY_DIMENSION(0.,0.);
#223=BODY_DIMENSION(0.,0.);
#224=FIXTURE_DIMENSION(50.,40.);
#225=FIXTURE_DIMENSION(50.,40.);

```

```
#226=TOUCH_TRIGGER_PROBE('PROBE NUM01', $, #224, #222, (#220));
#227=TOUCH_TRIGGER_PROBE('PROBE NUM01', $, #225, #223, (#221));
#228=PROJECT('EXECUTE EXAMPLE1', #219, (#203), (#226), $, $, $);
#229=ANGULARITY_TOLERANCE('ANGULARITY TOLERANCE ON DIAGONAL OPEN POCKET',
    (#395), #405, $, $, $, $, 0.1, $, (#235), $);
#230=DATUM_DEFINED_BY_FEATURE('DATUM PLANE C', $, 'BLOCK PLANE C');
#231=DATUM_DEFINED_BY_FEATURE('DATUM PLANE B', $, 'BLOCK PLANE B');
#232=DATUM_DEFINED_BY_FEATURE('DATUM PLANE A', $, 'BLOCK PLANE A');
#233=DATUM_DEFINED_BY_FEATURE('DATUM PLANE A,B,C', $, 'BLOCK PLANE A,B,C');
#234=DATUM_REFERENCE(1, #230);
#235=DATUM_REFERENCE(1, #231);
#236=DATUM_REFERENCE(1, #232);
#237=DATUM_REFERENCE(3, #233);
#238=DIRECTION(' AXIS ', (1., 0., 0.));
#239=DIRECTION(' REF_DIRECTION', (0., -1., 0.));
#240=DIRECTION(' AXIS ', (-1., 0., 0.));
#241=DIRECTION(' REF_DIRECTION', (0., -1., 0.));
#242=DIRECTION(' AXIS ', (1., 0., 0.));
#243=DIRECTION(' REF_DIRECTION', (0., -1., 0.));
#244=DIRECTION(' AXIS ', (0., 0., 1.));
#245=DIRECTION(' REF_DIRECTION', (1., 0., 0.));
#246=DIRECTION(' AXIS ', (0., 0., 1.));
#247=DIRECTION(' REF_DIRECTION', (1., 0., 0.));
#248=DIRECTION(' AXIS ', (0., 0., 1.));
#249=DIRECTION(' REF_DIRECTION', (1., 0., 0.));
#250=DIRECTION(' AXIS ', (0., 0., 1.));
#251=DIRECTION(' REF_DIRECTION', (1., 0., 0.));
#252=DIRECTION(' AXIS ', (0., 0., 1.));
#253=DIRECTION(' REF_DIRECTION', (1., 0., 0.));
#254=DIRECTION(' AXIS ', (0., 0., 1.));
#255=DIRECTION(' REF_DIRECTION', (1., 0., 0.));
#256=DIRECTION(' AXIS ', (0., 0., 1.));
#257=DIRECTION(' REF_DIRECTION', (1., 0., 0.));
#258=DIRECTION(' AXIS ', (0., 0., 1.));
#259=DIRECTION(' REF_DIRECTION', (1., 0., 0.));
#260=DIRECTION(' AXIS ', (0., 0., 1.));
#261=DIRECTION(' REF_DIRECTION', (1., 0., 0.));
#262=DIRECTION(' AXIS ', (0., 0., 1.));
#263=DIRECTION(' REF_DIRECTION', (1., 0., 0.));
#264=DIRECTION(' AXIS ', (0., 0., 1.));
#265=DIRECTION(' REF_DIRECTION', (1., 0., 0.));
#266=DIRECTION(' AXIS ', (-1., 0., 0.));
#267=DIRECTION(' REF_DIRECTION', (0., -1., 0.));
#268=DIRECTION(' AXIS ', (1., 0., 0.));
#269=DIRECTION(' REF_DIRECTION', (0., -1., 0.));
#270=DIRECTION(' AXIS ', (0., 1., 0.));
#271=DIRECTION(' REF_DIRECTION', (-1., 0., 0.));
#272=DIRECTION(' AXIS ', (0., 1., 0.));
#273=DIRECTION(' REF_DIRECTION', (0., 0., -1.));
#274=DIRECTION(' AXIS ', (0., 0., 1.));
#275=DIRECTION(' REF_DIRECTION', (1., 0., 0.));
#276=DIRECTION(' AXIS ', (0., 0., 1.));
#277=DIRECTION(' REF_DIRECTION', (1., 0., 0.));
#278=DIRECTION(' AXIS ', (0., 0., 1.));
#279=DIRECTION(' REF_DIRECTION', (1., 0., 0.));
#280=DIRECTION(' STEP COURSE OF TRAVEL DIRECTION', (1., 0., 0.));
#281=DIRECTION(' AXIS ', (0., 0., 1.));
#282=DIRECTION(' REF_DIRECTION ', (1., 0., 0.));
```

```
#283=DIRECTION(' AXIS ',(0.,0.,1.));
#284=DIRECTION(' REF_DIRECTION',(1.,0.,0.));
#285=DIRECTION(' SLOT COURSE OF TRAVEL DIRECTION',(1.,0.,0.));
#286=DIRECTION(' AXIS ',(0.,1.,0.));
#287=DIRECTION(' REF_DIRECTION',(-1.,0.,0.));
#288=DIRECTION(' AXIS ',(0.,1.,0.));
#289=DIRECTION(' REF_DIRECTION',(0.,0.,-1.));
#290=DIRECTION(' STRATEGY SLOT: 1.DIRECTION',(1.,0.,0.));
#291=DIRECTION(' AXIS ',(0.,0.,1.));
#292=DIRECTION(' REF_DIRECTION',(1.,0.,0.));
#293=DIRECTION(' AXIS ',(0.,0.,1.));
#294=DIRECTION(' REF_DIRECTION',(1.,0.,0.));
#295=DIRECTION(' AXIS ',(0.,0.,1.));
#296=DIRECTION(' REF_DIRECTION',(1.,0.,0.));
#297=DIRECTION(' AXIS ',(0.,0.,1.));
#298=DIRECTION(' REF_DIRECTION',(1.,0.,0.));
#299=DIRECTION(' AXIS ',(0.,0.,1.));
#300=DIRECTION(' REF_DIRECTION',(1.,0.,0.));
#301=DIRECTION(' AXIS ',(0.,0.,1.));
#302=DIRECTION(' REF_DIRECTION',(1.,0.,0.));
#303=DIRECTION(' STRATEGY STEP: 1.DIRECTION',(0.,1.,0.));
#304=DIRECTION(' AXIS ',(0.,0.,1.));
#305=DIRECTION(' REF_DIRECTION',(1.,0.,0.));
#306=DIRECTION(' COURSE OF TRAVEL DIRECTION',(0.,1.,0.));
#307=CARTESIAN_POINT(' SYMMETRY TOLERANCED PLANE1: LOCATION ',
(48.,0.,0.));
#308=CARTESIAN_POINT(' SYMMETRY TOLERANCED PLANE2: LOCATION ',
(170.,0.,0.));
#309=CARTESIAN_POINT(' ANGULARITY TOLERANCED PLANE: LOCATION ',(57.,0.,
-22.));
#310=CARTESIAN_POINT(' SETUP1: LOCATION ',(0.,0.,0.));
#311=CARTESIAN_POINT(' SECPLANE1: LOCATION ',(0.,0.,30.));
#312=CARTESIAN_POINT(' CLAMPING_POSITION1',(0.,20.,25.));
#313=CARTESIAN_POINT(' CLAMPING_POSITION2',(100.,20.,25.));
#314=CARTESIAN_POINT(' CLAMPING_POSITION3',(0.,100.,25.));
#315=CARTESIAN_POINT(' CLAMPING_POSITION4',(100.,100.,25.));
#316=CARTESIAN_POINT(' WORKPIECE1:LOCATION ',(0.,0.,0.));
#317=CARTESIAN_POINT(' POCKET3: LOCATION ',(35.,133.,0.));
#318=CARTESIAN_POINT(' POCKET3: DEPTH ',(35.,133.,-41.));
#319=CARTESIAN_POINT(' POCKET4: LOCATION ',(111.,133.,0.));
#320=CARTESIAN_POINT(' POCKET4: DEPTH ',(111.,133.,-41.));
#321=CARTESIAN_POINT(' SQUARE OPEN POCKET: LOCATION ',(48.,0.,0.));
#322=CARTESIAN_POINT(' SQUARE OPEN POCKET: DEPTH ',(48.,0.,-22.));
#323=CARTESIAN_POINT(' DIAGONAL OPEN POCKET: LOCATION ',(57.,0.,-22.));
#324=CARTESIAN_POINT(' DIAGONAL OPEN POCKET: DEPTH ',(57.,0.,-23.));
#325=CARTESIAN_POINT(' P1',(0.,0.,0.));
#326=CARTESIAN_POINT(' P2',(0.,116.,0.));
#327=CARTESIAN_POINT(' P3',(122.,116.,0.));
#328=CARTESIAN_POINT(' P4',(122.,0.,0.));
#329=CARTESIAN_POINT(' P1',(0.,0.,0.));
#330=CARTESIAN_POINT(' P2',(26.,97.,0.));
#331=CARTESIAN_POINT(' P3',(82.,97.,0.));
#332=CARTESIAN_POINT(' P4',(108.,0.,0.));
#333=CARTESIAN_POINT(' POSITION TOLERANCED PLANE ON BOSS1: LOCATION ',
(136.,158.,0.));
#334=CARTESIAN_POINT(' POSITION TOLERANCED PLANE ON BOSS2: LOCATION ',
(166.,158.,0.));
#335=CARTESIAN_POINT(' POSITION TOLERANCED PLANE ON BOSS3: LOCATION ',
```

```
(136.,195.,0.));
#336=CARTESIAN_POINT('POSITION TOLERANCED PLANE ON BOSS4: LOCATION ',
(136.,158.,0.));
#337=CARTESIAN_POINT('PARALLELISM TOLERANCED PLANE: LOCATION ',(0.,240.,
-30.));
#338=CARTESIAN_POINT('STEP: LOCATION ',(0.,240.,0.));
#339=CARTESIAN_POINT('STEP: DEPTH ',(0.,240.,-30.));
#340=CARTESIAN_POINT('SLOT:LOCATION',(59.,273.,-30.));
#341=CARTESIAN_POINT('SLOT: DEPTH ',(60.,270.,-20.));
#342=CARTESIAN_POINT('PERPENDICULARITY TOLERANCED PLANE1: LOCATION ',
(59.,293.,-30.));
#343=CARTESIAN_POINT('PERPENDICULARITY TOLERANCED PLANE2: LOCATION ',
(59.,273.,-30.));
#344=CARTESIAN_POINT('BOSS: LOCATION ',(136.,158.,-41.));
#345=CARTESIAN_POINT('BOSS: DEPTH ',(136.,168.,-41.));
#346=CARTESIAN_POINT('HOLE1: LOCATION ',(25.,308.,-30.));
#347=CARTESIAN_POINT('HOLE1: DEPTH ',(25.,308.,-60.));
#348=CARTESIAN_POINT('HOLE2: LOCATION ',(193.,308.,-30.));
#349=CARTESIAN_POINT('HOLE2: DEPTH ',(193.,308.,-60.));
#350=CARTESIAN_POINT('HOLE3: LOCATION ',(25.,258.,-30.));
#351=CARTESIAN_POINT('HOLE3: DEPTH ',(25.,258.,-60.));
#352=CARTESIAN_POINT('HOLE4: LOCATION ',(193.,258.,-30.));
#353=CARTESIAN_POINT('HOLE4: DEPTH ',(193.,258.,-60.));
#354=CARTESIAN_POINT('TOP SURFACE:LOCATION ',(0.,0.,5.));
#355=CARTESIAN_POINT('TOP SURFACE:DEPTH ',(0.,0.,-5.));
#356=AXIS2_PLACEMENT_3D('SYMMETRY TOLERANCED PLANE1',#307,#238,#239);
#357=AXIS2_PLACEMENT_3D('SYMMETRY TOLERANCED PLANE2',#308,#240,#241);
#358=AXIS2_PLACEMENT_3D('ANGULARITY TOLERANCED PLANE',#309,#242,#243);
#359=AXIS2_PLACEMENT_3D('SETUP1',#310,#244,#245);
#360=AXIS2_PLACEMENT_3D('PLANE1',#311,#246,#247);
#361=AXIS2_PLACEMENT_3D('WORKPIECE',#316,#248,#249);
#362=AXIS2_PLACEMENT_3D('POCKET3',#317,#250,#251);
#363=AXIS2_PLACEMENT_3D('POCKET3',#318,#252,#253);
#364=AXIS2_PLACEMENT_3D('POCKET4',#319,#254,#255);
#365=AXIS2_PLACEMENT_3D('POCKET4',#320,#256,#257);
#366=AXIS2_PLACEMENT_3D('SQUARE OPEN POCKET',#321,#258,#259);
#367=AXIS2_PLACEMENT_3D('SQUARE OPEN POCKET',#322,#260,#261);
#368=AXIS2_PLACEMENT_3D('DIAGONAL OPEN POCKET',#323,#262,#263);
#369=AXIS2_PLACEMENT_3D('DIAGONAL OPEN POCKET',#324,#264,#265);
#370=AXIS2_PLACEMENT_3D('POSITION TOLERANCED PLANE ON BOSS1',#333,#266,
#267);
#371=AXIS2_PLACEMENT_3D('POSITION TOLERANCED PLANE ON BOSS2',#334,#268,
#269);
#372=AXIS2_PLACEMENT_3D('POSITION TOLERANCED PLANE ON BOSS3',#335,#270,
#271);
#373=AXIS2_PLACEMENT_3D('POSITION TOLERANCED PLANE ON BOSS4',#336,#272,
#273);
#374=AXIS2_PLACEMENT_3D('PARALLELISM TOLERANCE ON STEP',#337,#274,#275);
#375=AXIS2_PLACEMENT_3D('STEP',#338,#276,#277);
#376=AXIS2_PLACEMENT_3D('STEP',#339,#278,#279);
#377=AXIS2_PLACEMENT_3D('SLOT:LOCATION',#340,#281,#282);
#378=AXIS2_PLACEMENT_3D('SLOT',#341,#283,#284);
#379=AXIS2_PLACEMENT_3D('PERPENDICULARITY ON SLOT',#342,#286,#287);
#380=AXIS2_PLACEMENT_3D('PERPENDICULARITY ON SLOT',#343,#288,#289);
#381=AXIS2_PLACEMENT_3D('BOSS',#344,#291,#292);
#382=AXIS2_PLACEMENT_3D('BOSS',#345,#293,#294);
#383=AXIS2_PLACEMENT_3D('HOLE1',#346,#295,#296);
#384=AXIS2_PLACEMENT_3D('HOLE1',#347,#295,#296);
```



```
#385=AXIS2_PLACEMENT_3D('HOLE2',#348,#297,#298);
#386=AXIS2_PLACEMENT_3D('HOLE2',#349,#297,#298);
#387=AXIS2_PLACEMENT_3D('HOLE3',#350,#299,#300);
#388=AXIS2_PLACEMENT_3D('HOLE3',#351,#299,#300);
#389=AXIS2_PLACEMENT_3D('HOLE4',#352,#301,#302);
#390=AXIS2_PLACEMENT_3D('HOLE4',#353,#301,#302);
#391=AXIS2_PLACEMENT_3D('TOP SURFACE',#354,#304,#305);
#392=AXIS2_PLACEMENT_3D('TOP SURFACE',#355,#304,#305);
#393=TOLERANCED_PLANE('SYMMETRY TOLERANCED PLANE1',#356,116.,22.,());
#394=TOLERANCED_PLANE('SYMMETRY TOLERANCED PLANE2',#357,116.,22.,());
#395=TOLERANCED_PLANE('ANGULARITY TOLERANCED PLANE',#358,85.35,23.,());
#396=TOLERANCED_PLANE('POSITION TOLERANCED PLANE ON BOSS1',#370,37.,41.,
());
#397=TOLERANCED_PLANE('POSITION TOLERANCED PLANE ON BOSS2',#371,37.,41.,
());
#398=TOLERANCED_PLANE('POSITION TOLERANCED PLANE ON BOSS3',#372,30.,41.,
());
#399=TOLERANCED_PLANE('POSITION TOLERANCED PLANE ON BOSS4',#373,30.,41.,
());
#400=TOLERANCED_PLANE('PARALLELISM TOLERANCED PLANE',#374,86.,218.,());
#401=TOLERANCED_PLANE('PERPENDICULARITY TOLERANCED PLANE',#379,100.,20.,
());
#402=TOLERANCED_PLANE('PERPENDICULARITY TOLERANCED PLANE',#380,100.,20.,
());
#403=SYMMETRY_TOLERANCE('SYMMETRY TOLERANCE ON SQUARE OPEN POCKET',(#393,
#394),#404,$,$,$,$,0.05,$,(#234),$);
#404=OPEN_POCKET('SQUARE OPEN POCKET',#203,(#144,#181),#366,(#403),#208,
(),$,#141,$,#130,#406,$);
#405=OPEN_POCKET('DIAGONAL OPEN POCKET',#203,(#146,#182),#368,(#229),
#209,(),$,#141,$,#132,#407,$);
#406=GENERAL_PROFILE($,#408);
#407=GENERAL_PROFILE($,#409);
#408=POLYLINE('CONTOUR OF POCKET1',(#325,#326,#327,#328));
#409=POLYLINE('CONTOUR OF POCKET2',(#329,#330,#331,#332));
ENDSEC;
END-ISO-10303-21;
```

---

# Appendix D Abstracts of Research Publications

## Journal papers:

- [D 1] Y. F. Zhao, X. Xu and S. Q. Xie. “STEP-NC Enabled On-line Inspection in Support of Closed-loop Machining”. *Robotics and Computer-Integrated Manufacturing*. Vol. 24 No. 2. pp 200–216, April 2008.
- [D 2] Y. F. Zhao, S. Habeeb and X. Xu. “Research into Integrated Design and Manufacturing Based on STEP”, *International Journal of Advanced Manufacturing Technology*, 44(5-6), pp 606-624, September 2009.
- [D 3] Y. F. Zhao, X. Xu and S. Xie. “Computer-Aided Inspection Planning - the State of the Art”. *Computers in Industry*, Vol.60, pp453-466, June 2009.
- [D 4] Y. F. Zhao and X. Xu. "Integrating Machining and Inspection". submitted to *International Journal of Computer Aided Engineering and Technology*, September 2008, *in press*.
- [D 5] Y. F. Zhao, X. Xu, Tom Kramer, Fred Proctor, and John Horst, “Dimensional Metrology Interoperability and standardization in Manufacturing Systems”, *Computer Standards & Interfaces*, submitted October 2009, *in-press*.
- [D 6] Y. F. Zhao and X. Xu, “An automated process planning system for cognitive manufacturing - integrating machining, inspection, and feedback”, submitted to special issue of *Cognitive Factory of Advanced Engineering Informatics*, December 2009.

## Conference papers:

- [D 7] Y. F. Zhao, X. Xu, S. Xie, T. Kramer, F. Proctor, and J. Michaloski. “An Integrated Process Planning System Architecture for Machining and On-Machine Inspection”. *Proceedings of the ASME 2008 International Design Engineering Technical Conferences & Computers and Information in Engineering Conference, IDETC/CIE 2008*, August 3-6, 2008, Brooklyn, New York, USA, DETC2008-49725.

- [D 8] Y. F. Zhao, X. Xu, and S. Xie, “Reactive Process Planning—Incorporating Machining, Inspection, and Feedback”, Proceedings of the ASME 2009 International Manufacturing Science and Engineering Conference, MSEC2009, October 4-7, Purdue University, West Lafayette, IN, USA, MSEC2009-84316.

## Appendix D.1 Journal Publication (6-1)

Y. F. Zhao, X. Xu and S. Q. Xie. "STEP-NC Enabled On-line Inspection in Support of Closed-loop Machining". *Robotics and Computer-Integrated Manufacturing*. Vol. 24 No. 2. pp 200–216, April 2008.



Available online at [www.sciencedirect.com](http://www.sciencedirect.com)



*Robotics and Computer-Integrated Manufacturing* 24 (2008) 200–216

Robotics  
and  
Computer-Integrated  
Manufacturing

[www.elsevier.com/locate/rcim](http://www.elsevier.com/locate/rcim)

### STEP-NC enabled on-line inspection in support of closed-loop machining

Fiona Zhao, Xun Xu\*, Shane Xie

*Department of Mechanical Engineering, University of Auckland, 20 Symonds Street, Auckland, New Zealand*

Received 16 May 2006; received in revised form 21 August 2006; accepted 20 October 2006

#### Abstract

The object-oriented STEP-NC data model provides a seamless and integrated programming interface for on-machine (or also known as on-line or in-line) inspections as well as interoperable manufacturing. This paper proposes a STEP-NC data model for on-line inspections. A framework of STEP-NC enabled closed-loop machining is also presented. The aim is to achieve a fully closed computer-aided design, process planning, machining and inspection chain. A new version of STEP-NC Interpreter has been developed to implement the proposed framework. A case study is included to demonstrate the implementation.

© 2006 Elsevier Ltd. All rights reserved.

**Keywords:** Machining; On-machine inspection; Closed-loop machining; STEP-NC

#### 1. Introduction

Manufacturing is a collection of interrelated activities including product design and documentation, material selection, planning, production, quality assurance, management and marketing of goods [1]. Closed-loop machining (CLM) is a method to maximize efficiency of a machining process by maintaining a tight control in a manufacturing system. It is normally regarded as the highest level of CNC automation [2]. The history of CLM may date back 50 years ago when manual tolerance charts were introduced into the industry for dimensional control in machining processes [3]. It is regarded that reliable machines, robust processes, automatic data collection and continuous improvement of machining process are the necessary elements of a CLM system. A closed loop, which always includes CNC machines, may also include CAM, CAPP or even CAD. In this research, a closed loop with a limited scope (including CNC and CAM) is considered [2,4].

Inspection is an essential element in a closed-loop manufacturing system. It can gather data to achieve precise measurement and monitor machine tool's performance during the operation. In most CLM systems, coordinate measuring machine (CMM) is widely employed as a way of collecting the measured data from a machined part. However, there are problems in this type of CLM systems. These problems relate to time, compatibility and data modeling.

- (1) Inspection using CMM is an off-line operation. It leads to increase in machining cycle time due to relocating workpiece between machines and CMMs.
- (2) Inspection using CMM is typically a three stage activity: programming, execution of the program and evaluation of the results. These activities are often carried out on separate systems which lead to complex interface problems. Common exchange standards are not new to the metrology industry. The Dimensional Measurement Interface Standard (DMIS) [5], which is widely used for CMM data interoperability, allows programs to be shared between different pieces of

\*Corresponding author. Tel.: +649 373 7599; fax: +649 373 7479.  
E-mail address: [x.xu@auckland.ac.nz](mailto:x.xu@auckland.ac.nz) (X. Xu).

## Appendix D.2 Journal Publication (6-2)

Y. F. Zhao, S. Habeeb and X. Xu. "Research into Integrated Design and Manufacturing Based on STEP", *International Journal of Advanced Manufacturing Technology*, 44(5-6), pp 606-624, September 2009.

Int J Adv Manuf Technol (2009) 44:606–624  
DOI 10.1007/s00170-008-1841-6

ORIGINAL ARTICLE

### Research into integrated design and manufacturing based on STEP

Yaoyao F. Zhao · Salah Habeeb · Xun Xu

Received: 24 August 2008 / Accepted: 6 November 2008 / Published online: 26 November 2008  
© Springer-Verlag London Limited 2008

**Abstract** This paper discusses a typical STEP-compliant manufacturing environment, which effectively integrates two systems. The first generates native data that retain the information needed to machine a part on a particular machine tool, whereas the second carries out optimization for machining parameters using the dispatched information from the first system. The related research work is divided into four areas, feature generation, macro process planning, micro process planning, and machining execution. The main part of the paper is devoted to reviewing the most recent research publications. The publications have been organized into the four areas as mentioned above. The discussion section that follows looks at the STEP-compliant research from the perspectives of industrial adoption, feature recognition for process planning, challenges in STEP-enabled inspection and STEP-NC controllers.

**Keywords** Design · Manufacturing · Integration · STEP · STEP-NC

Y. F. Zhao · X. Xu (✉)  
Department of Mechanical Engineering, University of Auckland,  
20 Symonds Street,  
Auckland, New Zealand  
e-mail: x.xu@auckland.ac.nz

Y. F. Zhao  
e-mail: yzha306@aucklanduni.ac.nz

S. Habeeb  
Intermech Ltd,  
PO Box 204013, Highbrook 2161, 49 Business Parade,  
Auckland, New Zealand  
e-mail: salah.habeeb@intermech.co.nz

#### 1 Introduction

In today's industry, product data throughout the lifecycle is often managed in different systems. Each of these systems has its own data format, so the same information is entered multiple times into different systems at different design phases leading to possible data redundancy and error. Industry vendors and users have since been seeking a common language to be used in an integrated system that can describe the entire product data throughout its lifecycle. Many solutions were proposed, the most successful being the Standard for Exchange of Product data model (STEP) [1]. STEP provides a mechanism that is capable of describing product data, independent from any particular system. The nature of this description makes it suitable not only for neutral file exchange, but also as a basis for implementing, sharing, and archiving product databases.

For various types of product data, STEP uses Application Protocols (APs). APs are formal documents that cover a set of activities in the lifecycle of a product. Every AP defines a set of activities, information requirements and a formal schema that is tied to an integrated product model shared between all APs. An AP is developed through three phases: (1) Application Activity Model (AAM) identifies and analyses process requirements in an application domain; (2) Application Reference Model (ARM) describes the pieces of product information described in the AAM in terms of basic Application Objects (AO); and (3) Application Interpreted Model (AIM) is formed by using an EXPRESS information model to capture everything in the ARM and to tie it to a library of pre-existing definitions (e.g., Integrated Resources).

ISO 10303-AP203 [2] is the first and perhaps the most successful AP developed to exchange design data between different CAD systems. After the initial release of AP203, other APs have been developed to support their particular

## Appendix D.3 Journal Publication (6-3)

Y. F. Zhao, X. Xu and S. Xie. "Computer-Aided Inspection Planning - the State of the Art". *Computers in Industry*, Vol.60, pp453-466, June 2009.

Computers in Industry 60 (2009) 453–466



Contents lists available at ScienceDirect

Computers in Industry

journal homepage: [www.elsevier.com/locate/compind](http://www.elsevier.com/locate/compind)



Survey paper

### Computer-Aided Inspection Planning—The state of the art

Fiona Zhao, Xun Xu\*, S.Q. Xie

University of Auckland, Department of Mechanical Engineering, 20 Symonds Street, Auckland, New Zealand

#### ARTICLE INFO

##### Article history:

Received 3 October 2007  
Received in revised form 30 September 2008  
Accepted 5 February 2009  
Available online 5 March 2009

##### Keywords:

Computer-Aided Inspection Planning (CAIP)  
STEP-NC  
On-Machine Inspection (OMI)  
Integration

#### ABSTRACT

Computer-Aided Inspection Planning (CAIP) has been a research topic for the past 25 years. Most of the CAIP systems were developed for Coordinate Measuring Machines (CMMs). The authors reviewed these CAIP systems and categorized them into two groups: tolerance-driven and geometry-based CAIP systems. Compared with CMMs, On-Machine Inspection (OMI) systems provide direct inspection in manufacturing and quality control, which is vital for automated production. Since the early 1990s, new CAIP systems have been developed for OMI systems. New technologies were developed in improving CAIP. New product data standards such as STEP and STEP-NC have been developed to provide standardized and comprehensive data models for machining and inspections. This paper systematically reviewed the recent development of these CAIP systems, new standard and technologies. A new notion of integrating the machining and inspection process planning based on the STEP-NC standard is discussed.

© 2009 Elsevier B.V. All rights reserved.

#### Contents

|  |     |
|--|-----|
| 1. Introduction .....  | 453 |
| 2. Benefits and implementation requirement of On-Machine Inspection .....              | 454 |
| 3. Computer-Aided Inspection Planning (CAIP) systems for OMI and CMMs .....            | 454 |
| 3.1. Early research (prior to 1995) on CAIP systems .....                              | 455 |
| 3.1.1. Tolerance-driven CAIP systems .....   | 455 |
| 3.1.2. Geometry-based CAIP systems .....   | 456 |
| 3.2. Recent CAIP research for OMI and CMMs .....                                       | 456 |
| 3.2.1. Inspection feature selecting and sequencing .....                               | 457 |
| 3.2.2. Measuring/sampling points selection and optimization for both CMM and OMI ..... | 460 |
| 3.2.3. Probing path planning and generation .....                                      | 461 |
| 4. STEP and STEP-NC enabled inspections .....  | 462 |
| 5. Discussions .....   | 463 |
| 6. Conclusion and future trends .....  | 464 |
| References .....   | 464 |

---

## Appendix D.4 Journal Publication (6-4)

Y. F. Zhao and X. Xu. "Integrating Machining and Inspection". submitted to International Journal of Computer Aided Engineering and Technology, September 2008, *in press*.

*Int. J. Computer Aided Engineering and Technology, Vol. x, No. x, 20xx*

---

### Integration of Machining and Inspection

---

Y. F. Zhao, X. Xu.\*

University of Auckland, Department of Mechanical Engineering,  
20 Symonds Street, Auckland, New Zealand  
E-mail: x.xu@auckland.ac.nz

\*Corresponding author

**Abstract:** Inspection is an essential part of the entire manufacturing chain providing measurement feedback to a process planning system. Fully automated machining would require automatic inspection process planning and real-time inspection result feedback. As inspection process planning is still based on G&M codes containing low-level information or vendor-specific bespoke routines, inspection process planning is mostly isolated from machining process planning. With the development of new data model standards such as STEP and STEP-NC providing high-level product information for the entire manufacturing chain, it is conceivable that both machining and inspection process planning are considered hand-in-hand to generate optimal machining and inspection sequences with real-time measurement result feedback. This paper introduces an integrated process planning system architecture for combined machining and inspection. In order to provide real-time inspection feedback, On-Machine Inspection (OMI) is chosen to carry out inspection operations. A case study testified the feasibility of the proposed architecture.

**Keywords:** integrated process planning, on-machine inspection, STEP-NC, feedback.

**Biographical notes:** Y. F. Zhao is presently a PhD student in the Department of Mechanical Engineering of the University of Auckland in New Zealand. She received her BD from the Department of Flight Vehicle Engineering in Beijing Institute of Technology in China and ME (honours) from the Department of Mechanical Engineering in the University of Auckland in New Zealand in 2003 and 2006, respectively. Her current research topic is STEP/STEP-NC-enabled integrated process planning system incorporating machining, inspection, and feedback.

Xun Xu received his BSc and MSc from Shenyang Jianzhu University and Dalian University of Technology, PR china in 1982 and 1988, respectively. In 1996, he received a PhD from the University of Manchester Institute of Science and Technology (UMIST), UK. He is now an associate professor at the Department of Mechanical Engineering, the University of Auckland, New Zealand. Dr. Xu is a member of ASME and IPENZ. In addition to his teaching and research activities at the University of Auckland, Dr. Xu has been actively engaged in various industrial consultancy works. He heads the Manufacturing Systems Laboratory and the CAD/CAM Laboratory in the University of Auckland. Dr. Xu has published numerous research monographs and is on the editorial boards for a number of international journals. His main interests lie in the areas of CAD/CAPP/CAM, STEP, and STEP-NC.

## Appendix D.5 Journal Publication (6-5)

Y. F. Zhao, X. Xu, Tom Kramer, Fred Proctor, and John Horst, “Dimensional Metrology Interoperability and standardization in Manufacturing Systems”, *Computer Standards & Interfaces*, submitted October 2009, *in-press*.

Computer Standards & Interfaces xx(20xx)



### Dimensional Metrology Interoperability and Standardization in Manufacturing Systems

Yaoyao F. Zhao<sup>1</sup>, Xun Xu<sup>1\*</sup>, Tom Kramer<sup>2</sup>, Fred Proctor<sup>2</sup>, John Horst<sup>2</sup>

<sup>1</sup> *Department of Mechanical Engineering, University of Auckland, Auckland 1142, New Zealand*

<sup>2</sup> *Intelligent Systems Division, National Institute of Standards and Technology (NIST), Gaithersburg, MD 20899, USA*

#### ARTICLE INFO

##### Keywords:

Dimensional metrology  
Interoperability  
Standard development  
STEP  
DMIS

#### ABSTRACT

Dimensional metrology is an important part of any manufacturing system. It consists of distinct components and requires a large, diverse, and interconnected knowledge base. How to pass information seamlessly with minimal cost and minimal data loss between different components of a dimensional metrology system is a major issue that concerns software and hardware vendors, standards developers, and customers. This paper focuses on the four main elements of a dimensional metrology system: product definition, measurement process plan definition, measurement process execution, and analysis and reporting of quality data. The activities and software modules that are involved in these elements are discussed. Key issues that cause interoperability problems are identified. These issues are discussed as they relate to the current situation in dimensional metrology standards development. The STEP (ISO 10303) standards are the product of an international effort to achieve interoperability for manufacturing systems. Extending STEP is an appropriate way to solve the interoperability problem within dimensional metrology systems. Further development of STEP standards is proposed so that Geometric Dimensioning and Tolerancing (GD&T) information already available in STEP can be linked with manufacturing feature information, measurement technology, and measurement results. The proposed STEP data model is an attempt to provide a standard that will support automatic measurement process plan generation for in-process on-machine measurement. Some case studies are under way to test the model.

© 2010 Elsevier B.V. All rights reserved.



---

**Appendix D.6      Journal Publication (6-6)**

Y. F. Zhao and X. Xu, “An automated process planning system for cognitive manufacturing - integrating machining, inspection, and feedback”, submitted to special issue of Cognitive Factory of Advanced Engineering Informatics, December 2009.

**An automatic process planning system for cognitive  
manufacturing – integrating machining, inspection, and  
feedback**

***Abstract***

With the manufacturing industry shifting from seller markets to buyer markets and increasing dynamics from rising customer demands, increasing number and variety of products, and changing market demands, flexibility and changeability became main enablers for an efficient production. Process planning for such flexible manufacturing systems need to be adaptive to different machine tools and manufacturing environment. Real-time acquisition of production and process data and a suitable feedback to the process control is essential. However, the current information flow between different manufacturing processes is segmented due to the lack of consolidated data model to represent sufficient information. This directly results in the isolation between machining and inspection process planning. Therefore, the feedback from measurement to machining process is mostly post-process. This paper presented a consolidated data model and system structure for an automatic and integrated process planning for machining, inspection, and feedback. The data model is based from newly developed ISO standard STEP/STEP-NC, which provides semantic level information for the manufacturing system. The system structure and algorithms developed for the system are described first. A software prototype was developed as the implementation and was used to test the proposed data model and the integrated process planning and feedback system.

**Key words:** automated and integrated process planning, in-process measurement, real-time monitoring, on-line feedback, STEP/STEP-NC

## Appendix D.7 Conference Publication (2-1)

Y. F. Zhao, X. Xu, S. Xie, T. Kramer, F. Proctor, and J. Michaloski. "An Integrated Process Planning System Architecture for Machining and On-Machine Inspection". Proceedings of the ASME 2008 International Design Engineering Technical Conferences & Computers and Information in Engineering Conference, IDETC/CIE 2008, August 3-6, 2008, Brooklyn, New York, USA, DETC2008-49725.

Proceedings of the ASME 2008 International Design Engineering Technical Conferences & Computers and Information in Engineering Conference  
 IDETC/CIE 2008  
 August 3-6, 2008, Brooklyn, New York, USA

**DETC2008-49725**

### AN INTEGRATED PROCESS PLANNING SYSTEM FOR MACHINING AND ON-MACHINE INSPECTION

Yaoyao F. Zhao<sup>1</sup>, Xun W. Xu<sup>1\*</sup>, Shane Xie<sup>1</sup>, Tom R. Kramer<sup>2</sup>, Fred M. Proctor<sup>2</sup>, John L. Michaloski<sup>2</sup>

<sup>1</sup> Department of Mechanical Engineering  
 University of Auckland, Auckland 1142, New Zealand

<sup>2</sup> Intelligent Systems Division, National Institute of Standards and Technology (NIST)  
 Gaithersburg, MD 20899, USA

#### ABSTRACT

Inspection process is an essential part of the entire machining chain providing measurement feedback to the process planning system. Fully automated machining process requires automatic inspection process planning and real-time inspection result feedback. As inspection process planning is still based on the G&M code containing low-level information or vender-specific bespoke routine, inspection process planning is mostly isolated from machining process planning. With the development of new data model standards STEP and STEP-NC providing high-level product information for the entire machining chain, hence it is achievable to combine machining and inspection process planning to generate optimal machining and inspection sequence with real-time measurement result feedback. This paper introduces an integrated process planning system framework for combined machining and inspection. In order to provide real-time inspection feedback, On-Machine Inspection (OMI) is chosen to carry out inspection operations. Implementation of the proposed system has been partially carried out with a newly developed data model and an interpreter software. A case study was carried out to test the feasibility of the proposed system.

#### 1 INTRODUCTION

Inspection process planning is a part of the design and manufacturing activity that determines which characteristics of a product are to be inspected, where and when. Modern manufacturing is increasingly characterized by low volume, high variety production, tight tolerance, and high quality products. Part and product inspection is evolving to be an important module of integrated manufacturing [1]. In a conventional quality control system, a workpiece machined on a machining centre requires to be moved to a Coordinate

Measuring Machine (CMM) that checks its dimensional accuracy. The manual job set-up and inspection of machined parts are usually time consuming, subject to human errors, and often lead to longer lead time and the need to rework. These problems are further compounded with the difficulty of capital investment and time delay of material flow between CMMs and machine tools in the factory. Touch-trigger probes allow manufacturers to inspect workpiece, assist job set-ups, deliver precise components, minimize scraps and maximize productivity.

Recently, the On-Machine Inspection (OMI) or On-Machine Measurement (OMM) is widely-used as the essential measuring equipment for the purpose of direct inspections in manufacturing and quality control, which is vital to an automated production system. OMI is a process that integrates the design, machining, and inspection aspects of manufacturing to allow a product to be inspected and accepted directly on a machine tool. This process is accomplished by using the machine tool as the inspection device while the part is secured on the machining center with its coordinate system intact [2]. The benefits of OMI can be summarized as follows [3-7]:

- 1) Cost and time saving;
- 2) Change from reactive inspection to proactive control;
- 3) Elimination of non-value added operations;
- 4) Agile machining.

Computer-Aided Inspection Planning (CAIP) systems have been under research for about two decades. Most of the research in this area focused on developing CAIP system for CMMs. With the development of touch trigger probes and the increasing demand for automated production systems, OMI becomes widely-used and developed for the purpose of direct

\* Author for contact: Associate Professor Xun Xu, Email: [x.xu@auckland.ac.nz](mailto:x.xu@auckland.ac.nz), Phone: (0064) 9 373 7599, Fax: (0064) 9 373 7479

## Appendix D.8 Conference Publication (2-2)

Y. F. Zhao, X. Xu and S. Xie, “Reactive Process Planning—Incorporating Machining, Inspection, and Feedback”, Proceedings of the ASME 2009 International Manufacturing Science and Engineering Conference, MSEC2009, October 4-7, Purdue University, West Lafayette, IN, USA, MSEC2009-84316.

Proceedings of the ASME 2009 International Manufacturing Science and Engineering Conference  
MSEC 2009  
October 4-7, 2009, West Lafayette, Indiana, USA

**MSEC2009-84316**

### REACTIVE PROCESS PLANNING – INCORPORATING MACHINING, INSPECTION, AND FEEDBACK

Yaoyao F. Zhao, Xun W. Xu\*, Sheng Q. Xie

Department of Mechanical Engineering  
University of Auckland, Auckland 1142, New Zealand

#### ABSTRACT

Closed-Loop Manufacturing (CLM) techniques include machine tool self-checks, automated setups, tool measurement, in-process probing with process adjustment, on-machine final inspection, data collection and data analysis. All of these elements and more are utilized to collect data in a mostly automated fashion to subsequently correct and adjust undesired conditions that can affect part quality. Inspection process planning plays an essential part of CLM. As G&M codes that contains low-level information or vendor-specific bespoke routines is the primary programming language, inspection process planning is mostly isolated from machining process planning. With the development of new data model standards such as STEP and STEP-NC providing high-level product information for the entire manufacturing chain, it is conceivable that both machining and inspection process planning are considered hand-in-hand to generate optimal machining and inspection sequences with real-time measurement feedback for the CLM scenario. This paper introduces an reactive process planning system architecture that incorporates machining, inspection, and feedback. In order to provide real-time inspection feedback, On-Machine Measurement (OMM) is chosen to carry out inspection operations. Implementation of the proposed architecture has been partially carried out with newly developed data model and interpreter. A case study testified the feasibility of the proposed architecture.

#### 1 INTRODUCTION

Closed-Loop Manufacturing (CLM) is a method for optimizing the efficiency of a manufacturing process. It involves the use of measurement technology, most often touch sensor probes, to determine actual part dimensions as well as coordinates of machine tool characteristics [1]. The data that is collected during the measurements is the basis for various kinds of optimization loops targeting at different aspects of manufacturing process. Utilizing CLM for manufacturing

processes improves the reliability of the machine, provides a more controlled environment and lessens the human error involved with offset modification. In some business cases, it can become extremely beneficial to utilize the machine tool for inspection in order to free-up capacity on the Coordinate Measuring Machine (CMM). CLM makes this possible.

Manufacturing, at its best, is standardized. CLM aims to standardize. CLM uses on machine probing technology to assure an acceptable accuracy level of the machinery, to set tool dimensions, to automate setups, to measure part features for in-process offset adjustments as well as for finished dimensions. The loop is closed when the measurements are controlled and when they are utilized to improve the capability of the manufacturing process. The use of CLM data is not only applied within the machine's control when adjusting offsets, but also utilized by engineers who analyze the process data over time to evaluate retargeting of dimensions, to modify tolerance requirements or to use the gained knowledge to better design parts for their producibility.

Using the measurement of workpiece as a check on the CLM process is well established but there are a number of issues as to where to measure, what to measure and when to measure. There are three types of measurement in manufacturing processes listed as following.

- 1) In-process measurement.
  - a) with on-machine measurement, which takes place as the workpiece is being made.
  - b) with portable measurement, where the workpiece surface is tested when the part has been made but not moved. The surface instrument, which is hand-held, has somehow to be perched on the part when the machining has stopped and then the measurement recorded.
- 2) In situ measurement. The workpiece is removed from the machine and the measured with an instrument located near to the machine tool.

\* Author for contact: Associate Professor Xun Xu, Email: [x.xu@auckland.ac.nz](mailto:x.xu@auckland.ac.nz), Phone: (0064) 9 373 7599, Fax: (0064) 9 373 7479