



HAL
open science

Fonctions sur l'ensemble des diagrammes de Young : caractères du groupe symétrique et polynômes de Kerov

Valentin Féray

► **To cite this version:**

Valentin Féray. Fonctions sur l'ensemble des diagrammes de Young : caractères du groupe symétrique et polynômes de Kerov. Mathématiques générales [math.GM]. Université Paris-Est, 2009. Français. NNT : 2009PEST1013 . tel-00418482v2

HAL Id: tel-00418482

<https://pastel.hal.science/tel-00418482v2>

Submitted on 1 Dec 2010

HAL is a multi-disciplinary open access archive for the deposit and dissemination of scientific research documents, whether they are published or not. The documents may come from teaching and research institutions in France or abroad, or from public or private research centers.

L'archive ouverte pluridisciplinaire **HAL**, est destinée au dépôt et à la diffusion de documents scientifiques de niveau recherche, publiés ou non, émanant des établissements d'enseignement et de recherche français ou étrangers, des laboratoires publics ou privés.



THÈSE DE DOCTORAT

pour l'obtention du grade de

Docteur de l'Université Paris-Est

Spécialité Mathématiques

au titre de l'École Doctorale Information, Communication, Modélisation et Simulation

Présentée et soutenue publiquement par

Valentin Féray

le 9 mars 2009

Fonctions sur l'ensemble des diagrammes de Young : caractères du groupe symétrique et polynômes de Kerov

Sous la direction de :

Philippe Biane

Devant le jury composé par:

Rapporteurs : Grigori Olshanski, leading researcher (Russian Academy of Science)
Gilles Schaeffer, directeur de recherche CNRS (École Polytechnique)

Examineurs : Alain Lascoux, directeur de recherche CNRS (Marne-La-Vallée)
Vic Reiner, professor (Minnesota)
Jean-Yves Thibon, professeur des universités (Marne-La-Vallée)

Directeur : Philippe Biane, directeur de recherche CNRS (Marne-La-Vallée)

Remerciements

Il paraît tout à fait naturel de commencer cette partie de remerciements par mon directeur de thèse Philippe Biane. Dire que ce mémoire n'aurait pas pu voir le jour sans lui est une tautologie. Il n'est pas moins évident que c'est une chance d'avoir pu travailler avec quelqu'un ayant une connaissance aussi vaste de divers champs de mathématiques. Il a su se rendre disponible et me donner des conseils pertinents à chaque fois que j'en ai eu besoin tout en me laissant une grande autonomie dans ma recherche. Je profite donc de l'occasion pour le remercier pour ses conseils et ses explications, mais aussi pour son aide dans la mise en forme de mes travaux. C'est quelqu'un dont j'admire l'ouverture d'esprit mathématique et ces années sous sa direction m'ont fait redécouvrir constamment la richesse et la complexité des mathématiques.

Je voudrais ensuite remercier Gilles Schaeffer et Grigori Olshanski d'avoir accepté d'écrire un rapport sur cette longue thèse. Certains travaux de Grigori Olshanski sont à l'origine des problèmes étudiés dans cette thèse et ont été des sources d'inspiration de mes travaux. Quant à Gilles Schaeffer, je voudrais aussi le remercier de m'avoir invité à l'École Polytechnique pour que je puisse y exposer les problèmes combinatoires rencontrés. Grâce à sa vue d'ensemble du domaine, les discussions avec lui ont toujours été stimulantes.

Alain Lascoux, Vic Reiner et Jean-Yves Thibon ont aussi accepté de faire partie du jury de ma thèse. Je les en remercie, ainsi que pour tous les conseils donnés et les remarques faites au cours de la thèse.

Cela m'amène à parler de l'intégralité de l'équipe qui m'a accueilli à Marne-La-Vallée. Personne n'a jamais hésité à prendre du temps pour m'expliquer un point de théorie ou écouter mes idées. Je remercie donc Jean-Christophe, Jean-Gabriel, Teresa, François, Franco, Pierre-Loïc, Jean-Paul ainsi que Jean-Yves, Philippe et Alain déjà cités mais aussi bien entendu nos visiteurs réguliers comme Florent et Nicolas.

L'omission dans la liste précédente d'Adrien est bien sûr volontaire, non qu'il ne m'ait jamais aidé (bien au contraire, il m'a en particulier fait gagner énormément de temps pour combler mon retard au niveau informatique) mais car j'ai eu l'occasion et le plaisir de travailler sur un sujet précis avec lui. Je le remercie donc particulièrement, ainsi que Piotr Śniady, autre coauteur. Ce dernier m'a aussi donné énormément des conseils et d'idées et m'a accueilli en Pologne. Son aide a été précieuse pour cette thèse et je le remercie donc énormément.

Je voudrais aussi dire un petit mot de Sergei Kerov, que je n'ai malheureusement pas pu rencontrer, mais dont les travaux ont été très importants pour mes recherches. Son œuvre mathématique est admirable et je tiens à lui faire un hommage ici.

Tous les gens cités plus haut, outre leurs qualités mathématiques, ont aussi de grandes qualités humaines. Ceci permet de faire du laboratoire d'informatique de Marne-La-Vallée et du monde de la combinatoire en général un lieu convivial, où je me suis toujours senti accueilli et à l'aise. Je pense que c'est aussi un facteur très important pour que la thèse se déroule bien. Par conséquent, je remercie les membres et personnels du laboratoire qui contribuent à une ambiance de travail saine, ainsi que toutes les personnes que j'ai eu l'occasion de rencontrer au cours de cette thèse.

Bien entendu, il serait absurde de limiter les remerciements à la sphère professionnelle. J'ai été énormément entouré pendant ces trois ans et cela me paraît être une base indispensable pour faire un bon travail. Vouloir faire ici une liste de toutes les personnes avec qui j'ai partagé des bons moments est peu réaliste, mais je sais que les intéressés se reconnaîtront. Je voudrais simplement remercier particulièrement mes parents, mon frère et ma sœur, ainsi que l'intégralité de la famille. Et évidemment Anne-Cécile avec qui j'ai tant partagé.

Contexte

L'étude des représentations des groupes symétriques est un domaine de recherche relativement ancien dans lequel on connaît de nombreux résultats : la classification des représentations irréductibles de $S(n)$, qui sont indexées par les partitions λ de n , et des algorithmes pour calculer, pour une représentation donnée, sa dimension et les valeurs du caractère associé χ^λ . Mais ces algorithmes ont une complexité relativement élevée et il est difficile de répondre à certaines questions théoriques, en particulier concernant leur comportement asymptotique.

De nouveaux outils ont donc été développés pour répondre à ce type de questions : l'idée est de regarder la valeur du caractère (normalisé) $\hat{\chi}^\lambda(\mu)$ comme une fonction de λ (alors qu'elle est traditionnellement vue comme une fonction de μ). Ce point de vue est présent, par exemple, dans l'article de Kerov et Olshanski [KO94] ou dans celui de Stanley [Sta03] qui introduit les coordonnées \mathbf{p} et \mathbf{q} des diagrammes multirectangulaires.

Le caractère peut alors être exprimé en fonction d'*observables* du diagramme λ . Les observables sont des nombres calculables à partir de la forme du diagramme de Young λ considéré. Avec une bonne normalisation des caractères, ces expressions ne dépendent pas de n . Cela permet de travailler dans une algèbre Λ^* de fonctions sur l'ensemble de tous les diagrammes de Young. Cette algèbre admet une graduation naturelle et plusieurs bases intéressantes.

Comme cela a déjà été évoqué, certaines de ces bases proviennent de l'évaluation de caractères sur des éléments du centre de l'algèbre du groupe symétrique $Z(\mathbb{C}[n])$, d'autres d'un calcul à partir de la forme du diagramme. Les éléments de Jucys-Murphy, qui ont à la fois une expression explicite dans $Z(\mathbb{C}[n])$ et une action facile à décrire sur les représentations irréductibles de $S(n)$, permettent de faire le lien entre ces deux types d'objets.

Un exemple de famille d'observables liée aux éléments de Jucys-Murphy sont les cumulants libres de la mesure de transition. Ceux-ci apparaissent naturellement dans certains modèles asymptotiques [Bia98], sont homogènes et contiennent toute l'information du diagramme. Les expressions des valeurs des caractères sur un cycle en fonction des cumulants libres sont appelées polynômes de Kerov [Bia03]. S.V. Kerov a conjecturé [Ker00] que leurs coefficients étaient positifs.

Contenu de ce mémoire

Mon travail de thèse s'inscrit dans cette perspective : étudier les représentations du groupe symétrique grâce à des égalités de fonctions sur l'ensemble des diagrammes de Young. La première partie (en français) rappelle les résultats précédents dans ce domaine et présente les résultats nouveaux dans cette perspective.

Les parties suivantes (en anglais) reprennent le contenu des articles rédigés pendant la thèse [Fér08b, FŚ07, Fér08a, DFŚ08, BF09] (par conséquent, les notations peuvent différer légèrement d'un chapitre à l'autre).

Dans la deuxième partie, nous établissons une formule combinatoire pour les valeurs des caractères (théorème 2.7). Cette formule, conjecturée par R.P. Stanley, donne l'expression du caractère normalisé $\hat{\chi}^\lambda(\sigma)$ en fonction des coordonnées \mathbf{p} et \mathbf{q} des diagrammes multirectangulaires. Deux preuves sont proposées dans ce mémoire. La première (chapitre 4) utilise les propriétés des éléments de Jucys-Murphy et les fonctions de Schur décalées. La seconde (paragraphe 5.2) est un calcul de trace dans l'algèbre du groupe symétrique : elle utilise le fait que la représentation irréductible associée à λ peut être décrite grâce au projecteur de Young.

Un des intérêts de cette formule est que sa complexité ne dépend que de la taille du support de la permutation σ et non de la taille de la permutation elle-même. Elle est donc très adaptée à une étude asymptotique du caractère $\hat{\chi}^\lambda(\sigma)$ sur une permutation σ fixée (complétée par des points fixes) quand la taille de λ tend vers l'infini. On retrouve ainsi la formule combinatoire de l'équivalent homogène du caractère sur un cycle ainsi qu'une borne supérieure optimale à un facteur multiplicatif près. Cette borne peut être étendue à des permutations dont la longueur varie avec $|\lambda|$ (théorème 5.1), améliorant ainsi les précédents résultats dans ce domaine.

Dans la troisième partie, nous étudions en détail les polynômes de Kerov. Encore une fois, nous proposons deux approches différentes au problème, utilisant toutes les deux le théorème 2.7. La première fait apparaître de la combinatoire sur des cartes. En effet, le caractère s'écrit comme une somme alternée de fonctions sur les diagrammes de Young indexés par des cartes. Dans le chapitre 1, nous étudions en détail ces fonctions et leurs relations. On définit ainsi une décomposition canonique des cartes étiquetées en somme alternée de produits d'arbres permettant d'interpréter combinatoirement les coefficients des polynômes de Kerov. Avec cette méthode, développée dans le chapitre 6, nous prouvons une version généralisée de la conjecture de Kerov et calculons les valeurs de certains coefficients.

La seconde manière d'aborder le problème est d'utiliser d'autres observables des diagrammes de Young. On peut alors déduire du théorème 2.7 une formule combinatoire pour le caractère dont tous les termes sont dans l'algèbre Λ^* . Ceci permet d'exprimer les coefficients des polynômes de Kerov comme une somme alternée de nombre de factorisations vérifiant des propriétés données. Après un travail combinatoire non trivial, nous simplifions cette expression pour obtenir une interprétation combinatoire explicite des coefficients, en-

traînant immédiatement la conjecture de Kerov.

La quatrième partie de ce mémoire est un peu à part. Elle montre comment la structure combinatoire qui est ressortie de l'étude des polynômes de Kerov peut être utilisée dans un autre domaine : l'étude d'identités sur des fractions rationnelles. On s'intéresse à des symétrisations partielles de la fraction rationnelle simple $\prod_i (x_i - x_{i+1})^{-1}$. L'objet étudié est une somme des images de cette fraction rationnelle par certaines permutations des variables. Les ensembles de permutations considérés sont les extensions linéaires des ensembles ordonnés, qui peuvent être représentés par des graphes orientés. Cela définit donc une famille de fractions rationnelles indexées par des graphes.

Or elles vérifient des relations très proches de celles des fonctions sur les diagrammes de Young étudiées au chapitre 1. Ces relations donnent un algorithme de calcul et permettent de montrer facilement (par récurrence) des liens entre propriétés algébriques des fonctions et combinatoire des graphes. Le fait que la structure de cartes joue un rôle important pour l'étude des polynômes de Kerov invite à munir dans ce problème les graphes d'une structure arbitraire de cartes. On obtient alors une formule combinatoire non récursive pour notre fraction rationnelle.

Ceci montre les apports de l'approche combinatoire proposée dans cette thèse à ces problèmes. Nous évoquons ensuite dans une conclusion rapide les pistes de recherche ouvertes par ces travaux.

Abstract

Context

The representation theory of symmetric groups is a quite old research field in mathematics. A lot is already known : the classification of irreducible representations of $S(n)$, indexed by partitions λ of n , and algorithms to compute, for a given representation, its dimension and the associated character values $\chi^\lambda(\sigma)$. But these algorithms have a high complexity and it is hard to use them to answer some theoretic questions, in particular the asymptotic ones.

Recently, new tools have been used to answer this kind of questions : the idea is to look at the (normalized) character value $\hat{\chi}^\lambda(\mu)$ as a function of λ (although it is more usual to consider it as a function of μ). One can find this insight for instance in Kerov's and Olshanski's paper [KO94], or in Stanley's [Sta03], where he introduced multirectangular Young diagrams.

In this context, character values can be written in terms of some *functionals* of the diagram λ . The functionals are some real numbers, easy to compute from the shape of the Young diagram. With a good normalization of character values, these expressions do not depend on n . Thus one can see them as equalities in an algebra Λ^* of functions on the set of all Young diagrams. This algebra has a natural graduation and several interesting basis.

As it has already been suggested, some of these basis are defined as character values on particular elements of the center of the symmetric group algebra $Z(\mathbb{C}[n])$, and others as the result of a computation using the shape of the diagram. The link between these two kinds of functions can be done thanks Jucys-Murphy elements : they are defined by explicit expressions in $Z(\mathbb{C}[n])$ and their action on irreducible representations of $S(n)$ has an easy description.

An example of an interesting family of functionals, linked to Jucys-Murphy elements, is the free cumulants of the transition measure. They appear in some asymptotic problems [Bia98], are homogeneous and one can recover from them the shape of the diagram. The expression of character values on cycles in terms of free cumulants are called Kerov polynomials [Bia03]. S.V. Kerov has conjectured [Ker00] the positivity of their coefficients.

Outline of this thesis

The first part (in french) recalls the previous results in the field and shows how our results fit in it. The following parts (in english) correspond to the papers written during my thesis [Fér08b, FŚ07, Fér08a, DFŚ08, BF09] (thus the notations can be a little different from a chapter to another).

In the second part, we prove a combinatorial formula for normalized character values $\hat{\chi}^\lambda(\sigma)$ (Theorem 4.1). This formula, conjectured by R.P. Stanley, gives irreducible character values in terms of the coordinates \mathbf{p} and \mathbf{q} of multirectangular diagrams. This formula is proved in two different ways. The first one (chapter 4) is based on the properties of Jucys-Murphy elements and shifted Schur functions. The second one (section 5.2) is a computation of trace in the symmetric group algebra : the main tool is the description of the irreducible representation associated to λ with Young's idempotent.

A very interesting aspect of this formula is its complexity, which only depends of the size of the support of the permutation σ and not of the size of the permutation itself. Thus it is very useful in an asymptotic study of character values $\hat{\chi}^\lambda(\sigma)$ on a fixed permutation σ (completed with fixed points) when the size of λ goes to infinity. We can recover this way a combinatorial formula for the homogeneous equivalent of character value on a cycle and, also, an upper bound. This bound, optimal up to a multiplicative factor for fixed permutations, can be extended to permutations σ whose length increases with $|\lambda|$ (Theorem 5.1). We improve this way the previous results in this direction.

In the third part, we focus on Kerov's polynomials. Once again, we propose two different approaches, both using Theorem 4.1. The first one is based on map combinatorics. Indeed, the character value can be written as an alternate sum of functions on the set of Young diagrams indexed by maps. Proposition 6.11 is a relation between these functions. By iterating it, we write in a canonical way the function of a labeled map as an alternate sum of products of tree functions. This gives a combinatorial interpretation of the coefficients of Kerov's polynomials. With this method, explained in chapter 6, we prove a generalized version of Kerov's conjecture and compute some coefficients.

The second way to attack the problem is to introduce a new family of functionals of Young diagrams. Then we can deduce from Theorem 4.1 a new combinatorial formula for character values, in which all terms belong to the algebra Λ^* . Using it, we can express the coefficients of Kerov's polynomials as an alternate sum of numbers of some factorizations. After a non trivial combinatorial work, we manage to simplify this expression to obtain an explicit combinatorial expression of the coefficients. This implies immediately Kerov's conjecture.

The subject of the fourth part is quite different from the others. It explains how the combinatorial structure which appear in our work on Kerov's polynomials can be used in an other domain : rational identities. We look at partial symmetrizations of the simple rational

function $\prod_i (x_i - x_{i+1})^{-1}$. The main object is a sum of its image by some permutations of the variables. The sets of permutations we consider are linear extensions of posets, which can be represented by oriented graphs. Thus, we define a family of rational functions indexed by graphs.

But these rational functions happen to verify relations close to Proposition 6.11. These relations give an algorithm to compute the rational functions and easy proofs (by induction) of some links between their algebraic properties and the combinatorics of the associated graphs. As the map structure is very important in the study of Kerov's polynomials, one may wonder whether it is interesting to endow our graphs with arbitrary map structure : this gives a non-inductive combinatorial formula of our rational function.

This shows the contribution of the combinatorial approach used in this thesis. In a small conclusion, we present some directions of research suggested by these results.

Table des matières

I	Introduction	21
1	Fonctions indexées par des graphes	23
1.1	Définitions	23
1.1.1	Partitions et diagrammes multirectangulaires	23
1.1.2	Graphes bicolores et fonctions associées	24
1.2	Relations	26
1.2.1	Boucles et transformations élémentaires	26
1.2.2	Une algèbre engendrée linéairement par les forêts	27
1.2.3	Nombre de forêts minimales	28
1.2.4	Graphes non bicolores et extensions linéaires	30
1.3	Une décomposition particulière pour les cartes	32
1.3.1	Qu'est-ce qu'une carte ?	33
1.3.2	Confluence partielle	37
1.3.3	Signe des différents termes	41
1.3.4	Coefficients des arbres	42
2	Groupe symétrique et représentations	45
2.1	Structure du groupe symétrique	45
2.1.1	Autour de la décomposition en cycles	45
2.1.2	Partitions non croisées	48
2.1.3	Recouvrement du groupe symétrique	50
2.1.4	Les éléments de Jucys-Murphy	54
2.2	Théorie des représentations et caractères	55
2.2.1	Représentations irréductibles du groupe symétrique	55
2.2.2	Caractères centraux	57
2.2.3	Formule de Frobenius	58
2.2.4	Élément de Jucys-Murphy et moment de la mesure de transition	59
2.2.5	Une nouvelle formule combinatoire pour le caractère	60
3	Différentes bases d'une algèbre graduée	63
3.1	Une algèbre graduée	63
3.1.1	Polynômes de Stanley	63
3.1.2	Termes de plus haut degré du caractère : les cumulants libres	64

3.1.3	Graduation de l'algèbre \mathcal{N}	65
3.1.4	Interprétation asymptotique de la graduation	66
3.2	Bases de Λ^*	67
3.2.1	Une base liée aux polynômes de Stanley	68
3.2.2	Les fonctions de Schur décalées	69
3.2.3	Polynômes de Kerov	70
3.2.4	Application : convergence de représentations	71
3.3	Étude des coefficients des polynômes de Kerov	73
3.3.1	Calcul des coefficients	73
3.3.2	Approche combinatoire	74
3.3.3	Lien entre les deux approches	77

II Caractères du groupe symétrique : formule exacte et comportement asymptotique 79

4	A combinatorial formula for character values	81
4.1	The main theorem	81
4.2	Useful objects	83
4.2.1	Stabilizers	83
4.2.2	Young basis	83
4.2.3	Jucys-Murphy elements	84
4.2.4	Shifted Schur functions	85
4.2.5	Orthogonality relations of the second kind	87
4.3	Proof of Stanley's conjecture	88
5	Asymptotics of characters of symmetric groups	91
5.1	Introduction	92
5.1.1	Normalized characters	92
5.1.2	Short history of the problem	92
5.1.3	The main result	93
5.1.4	Young diagrams	94
5.1.5	The main tool : reformulation of Stanley-Féray character formula	94
5.1.6	Overview of the paper	95
5.2	Stanley-Féray character formula	95
5.2.1	The original version of Stanley-Féray character formula	95
5.2.2	Equivalence of the two formulations of Stanley-Féray character formula	96
5.2.3	New proof of the Stanley-Féray formula	97
5.2.4	Generalization to Young diagrams on \mathbb{R}_+^2	99
5.3	Characters of symmetric groups, random matrices and free probability	100
5.3.1	Stanley-Féray character formula and random matrices	100
5.3.2	Formal Young diagrams	102
5.3.3	Free cumulants of the transition measure	102
5.3.4	Generalized circular operators	103
5.4	Technical estimates	104

5.4.1	Estimates for the number of colorings $N^\lambda(\sigma_1, \sigma_2)$	104
5.4.2	Estimates for the number of factorizations	105
5.5	Asymptotics of characters	107
5.5.1	Upper bound for characters : proof of Theorem 5.1	107
5.5.2	Error term for balanced Young diagrams	108
5.5.3	Characters of symmetric groups related to Thoma characters	109
5.5.4	Disjoint cumulants of conjugacy classes	110

III Étude combinatoire des coefficients des polynômes de Kerov 111

6	Combinatorial interpretation and positivity of Kerov's character polynomials	113
6.1	Introduction	114
6.1.1	Background	114
6.1.2	Normalized character	115
6.1.3	Minimal factorizations and non-crossing partitions	116
6.1.4	Kerov's polynomials	117
6.1.5	A combinatorial formula for character values	118
6.1.6	Generalized Kerov's polynomials	119
6.1.7	Organization of the article	121
6.2	Maps and polynomials	122
6.2.1	From permutations to maps	122
6.2.2	From graphs to polynomials	124
6.3	Map decomposition	126
6.3.1	Elementary decomposition	126
6.3.2	Complete decomposition	130
6.3.3	Signs	133
6.4	Decompositions and cumulants	134
6.4.1	Cumulant maps	134
6.4.2	Multiplicities	137
6.4.3	End of the proof of main theorem	139
6.5	Computation of some particular coefficients	139
6.5.1	How to compute coefficients ?	139
6.5.2	Low degrees in R	140
6.5.3	High degrees in p,q	142
7	Explicit combinatorial interpretation of Kerov polynomials	147
7.1	Introduction	147
7.1.1	Generalized Young diagrams	147
7.1.2	Normalized characters	149
7.1.3	Free cumulants	149
7.1.4	Kerov character polynomials	150

7.1.5	The main result : explicit combinatorial interpretation of the coefficients of Kerov polynomials	152
7.1.6	Characters for more complicated conjugacy classes	152
7.1.7	Idea of the proof : Stanley polynomials	154
7.1.8	Combinatorial interpretation of condition (e)	155
7.1.9	Transportation interpretation of condition (e)	156
7.1.10	Open problems	157
7.1.11	Exotic interpretations of Kerov polynomials	160
7.1.12	Applications of the main result	162
7.1.13	Overview of the paper	163
7.2	Functionals of measures	164
7.3	Generalized Young diagrams	167
7.3.1	Measure on a diagram and contents of a box	167
7.3.2	Functionals of Young diagrams	168
7.3.3	Kerov transition measure	169
7.3.4	Free cumulants of a Young diagram	169
7.3.5	Polynomial functions on the set of Young diagrams	169
7.4	Stanley polynomials and Stanley-Féray character formula	170
7.4.1	Stanley polynomials	170
7.4.2	Identities fulfilled by coefficients of Stanley polynomials	171
7.4.3	Stanley-Féray character formula	172
7.5	Toy example : Quadratic terms of Kerov polynomials	173
7.6	Combinatorial lemmas	175
7.6.1	Euler characteristic	175
7.6.2	Applications of Euler characteristic	176
7.7	Proof of the main result	179
7.8	Graph decomposition	181
7.8.1	Reformulation of the previous result	181
7.8.2	Equivalence of conditions (e) and (e^5)	182

IV Application de la combinatoire des polynômes de Kerov à des identités rationnelles sur les ensembles ordonnés 185

8	Application of graph combinatorics to rational identities of type A . . .	187
8.1	Introduction	188
8.1.1	Background	188
8.1.2	Main results	189
8.1.3	Open problems	189
8.1.4	Outline of the paper	190
8.2	Graphs and posets	191
8.2.1	Definitions and notations on graphs	191
8.2.2	Posets, graphs, Hasse diagrams and linear extensions	192
8.2.3	Elementary operations on graphs	193
8.3	Rational functions on graphs	193

8.3.1	Definition	193
8.3.2	Pruning invariance	194
8.3.3	Value on forests	195
8.4	The main transformation	195
8.4.1	Equality on linear extensions	195
8.4.2	Consequences on Greene functions	198
8.5	Some explicit computations of rational functions	199
8.5.1	Graphs with cyclomatic number 1.	199
8.5.2	Graphs with cyclomatic number 2.	200
8.5.3	Simple bipartite graphs	202
8.6	A combinatorial formula for N	203
8.6.1	Rooted maps and admissible cycles	204
8.6.2	Decomposition of rooted maps	206
8.6.3	Coefficients in $D_c(M)$	207
8.7	A condition of factorization	210
8.7.1	Chain factorization	210
8.7.2	Complete factorization of planar posets	213
8.7.3	Disconnecting chain and Möbius function	216

Table des figures

1.1	Diagramme de Young de la partition $(4, 2, 2, 1, 0, \dots)$	24
1.2	Diagramme multirectangulaire	24
1.3	Exemple de graphe bicolore	25
1.4	Exemple d'écriture du graphe de la figure 1.3 dans le diagramme de la figure 1.1	25
1.5	Exemple de boucle dans un graphe bicolore	26
1.6	Exemple de transformation élémentaire T_L	27
1.7	Exemple de graphe orienté	30
1.8	Exemple de boucle dans un graphe orienté	31
1.9	Exemple de transformation élémentaire sur un graphe orienté	31
1.10	Dessins de graphes	33
1.11	Surfaces de genre $0, 1, 2, \dots$	33
1.12	Un plongement de $G_{3,3}$ dans le tore	34
1.13	Exemples de carte (à gauche) et de plongement non cellulaire (à droite)	34
1.14	Trois plongements cellulaires différents du même graphe	34
1.15	La carte de gauche de la figure 1.14 dessinée dans le plan	35
1.16	Exemple de carte bicolore enracinée (avec les deux conventions)	36
1.17	Seule la troisième boucle est admissible de type 1.	37
1.18	Forme générale d'une carte enracinée sans boucle admissible de type 1.	38
1.19	Exemples de boucle admissible qui ne soit pas de type 1.	38
1.20	Une carte bicolore étiquetée avec sa racine et une boucle admissible	40

1.21	Résultat de la première transformation élémentaire	40
1.22	Après une itération supplémentaire de l'algorithme \mathcal{A}_1	40
1.23	Résultat final de la décomposition de C	41
1.24	Exemple de tour d'un arbre couvrant d'une carte enracinée	42
2.1	Exemple de carte associée à une paire de permutations	47
2.2	Graphe de Cayley de S_3 avec les transpositions comme générateurs	48
2.3	Seule la partition de droite est non-croisée.	50
2.4	L'ensemble ordonné $NC(3)$ (plus petit élément en haut)	50
2.5	Diagramme des factorisations de $(1, 2, 3, 4, 5, 6)$	51
2.6	Carte C contenant un arbre T en trait plein.	52
2.7	On remplace l'arbre par un polygone régulier ayant deux fois plus d'arêtes.	53
2.8	Cartes correspondant au minimum et au maximum de l'intervalle	53
2.9	Représentation du diagramme de Young $(4, 2, 2, 1)$ à la Russe	59
3.1	Différentes expressions du caractère central.	75
5.1	Bipartite graph associated to the factorization $(12) = (1)(2) \cdot (12)$	95
5.2	Example of a skew Young diagram for which Theorem 5.2 is false.	100
6.1	Young diagram associated to sequences \mathbf{p} and \mathbf{q} (french convention)	115
6.2	Example of a bicolored labeled map, with exactly one face whose associated word is 12345678	123
6.3	Illustration of definition of transformation T_L	125
6.4	Example of an elementary transformation.	125
6.5	One particular case of definition-theorem 6.13	128
6.6	General form of the connected component containing \star of a map appearing in $D_1(M)$	131
6.7	Map \overline{M}	132
6.8	Maps involved in the computation of the example.	132
6.9	Example of a well-labeled cumulant map of resultant $(1 \dots 17)$	135
6.10	Example of a map obtained by compressing the polygons of the cumulant map of figure 6.9.	136
6.11	Elementary decomposition of a map with two black vertexes	141
6.12	Maps contributing to terms of graded degree $r + s$ in $K'_{r,s}$	143
6.13	Maps contributing to terms of graded degree $k - 1$ in K_k	144
7.1	Young diagram $(4, 3, 1)$ drawn in the French convention	148
7.2	Young diagram $(4, 3, 1)$ drawn in the Russian convention. The profile of the diagram has been drawn in the solid line.	149
7.3	Generalized Young diagram $\mathbf{p} \times \mathbf{q}$ drawn in the French convention	154
7.4	Local transformations on graphs.	182
8.1	Example of chain factorization	189
8.2	An example of factorization, not contained in Theorem 8.18.	190

8.3	Example of a chain and a cycle C (we recall that orientations are from left to right).	192
8.4	Example of application of theorem 8.4	196
8.5	Example of a graph G with cyclomatic number 2.	200
8.6	Decomposition of $\Phi(G_{2,4})$.	203
8.7	Example of a map M with an admissible cycle of type 1.	205
8.8	A generic map M without admissible cycles of type 1	205
8.9	Example of a map M' with an admissible cycle of type 2.	205
8.10	Tour of a spanning tree of a map.	208
8.11	A graph G with a chain c , the components G_i of $G \setminus c$ and the corresponding regions $\overline{G_i}$.	210
8.12	Good choice of cycle	211
8.13	The graph G is strongly planar.	213
8.14	The graph G is planar, but not strongly planar.	214
8.15	A diamond	214
8.16	A non-planar poset for which Greene's formula is true.	216
8.17	Case 1 : $i \notin V_c$ and j is not in the same region than j .	217
8.18	Case 2 : $i \notin V_c$ and j is in the same region than i .	217
8.19	Case 3 : $i \in V_c$ and $j \notin V_c$.	218
8.20	Case 4 : i and j belong to V_c .	218

Principales notations

$ \lambda $	Taille de la partition λ	p 23
$\ell(\lambda)$	Longueur de la partition λ	p 23
\mathcal{Y}	Ensemble des diagrammes de Young	p 23
$\lambda(\mathbf{p}, \mathbf{q})$	Partition multirectangulaire (parfois notée $\mathbf{p} \times \mathbf{q}$)	p 24
$N^\lambda(G)$	Nombre d'écritures de G dans λ	p 25
$N(G)$	Fonction sur les diagrammes de Young $\lambda \mapsto N^\lambda(G)$	p 25
L	Boucle dans un graphe G (ou une carte C). Attention, au chapitre 8, le même objet est appelé <i>cycle</i> et noté C .	p 26
$E(L)$	Sous-ensemble des arêtes de la boucle L	p 26
$T_L(G)$	Somme alternée de sous-graphes de G	p 26
$D(C)$	Somme alternée de sous-forêts de la carte étiquetée C	p 39
$D_c(C)$	Somme de sous-arbres de la carte enracinée C	p 39
S_n	Groupe symétrique d'ordre n	p 45
$\mathbb{C}[S_n]$	Algèbre du groupe S_n	p 46
$Z(\mathbb{C}[S_n])$	Centre de $\mathbb{C}[S_n]$	p 46
C_λ	Somme des permutations de type λ	p 46
$a_{\lambda;n}$	Renormalisation de C_λ	p 46
$M^{\sigma,\tau}$	Carte bicolore associée à la paire de permutations (σ, τ)	p 47
$ \sigma $	Longueur de la permutation de σ	p 48
$NC(n)$	Ensemble des partitions non-croisées de n	p 49
ξ_i	i -ième élément de Jucys-Murphy	p 54
\mathcal{M}_n^k	Projection dans $\mathbb{C}[S_n]$ de la puissance k -ième du $n + 1$ -ième élément de Jucys-Murphy	p 54
$(V_\lambda, \rho_\lambda)$	Représentation irréductible de $S_{ \lambda }$ associé à λ	p 56
$c_h(T)$	Contenu de la case h du tableau T	p 57
χ^ρ	Caractère de la représentation ρ	p 57
$\chi^\lambda(\mu)$	Valeur du caractère de ρ_λ sur une permutation de type μ	p 57
$\Sigma_\mu(\lambda)$	Valeur renormalisée du caractère de la représentation ρ_λ sur une permutation de type μ (attention au changement de place de λ et μ : le caractère est maintenant vu comme une fonction de λ)	p 58
Λ^*	Algèbre de fonctions sur les diagrammes de Young engendrée linéairement par les Σ_μ	p 58
x_i, y_i	Minima et maxima locaux de la fonction w associée au diagramme λ	p 58
H_λ	Inverse de la transformée de Cauchy de la mesure de transition de λ	p 59
G_λ	Transformée de Cauchy de la mesure de transition de λ	p 60
$M_k(\lambda)$	Moment d'ordre k de la mesure de transition de λ	p 59
$R_k(\lambda)$	Cumulant libre d'ordre k de la mesure de transition de λ	p 65
$S_k(\lambda)$	Nouvelle famille d'observables du diagramme λ	p 68
s_μ^*	Fonction de Schur décalée (fonction sur les diagrammes de Young)	p 69
K_μ	Polynômes de Kerov généralisés	p 70
Σ'_μ	Déformation du caractère central Σ_μ	p 70
$\Psi(G)$	Fraction rationnelle associée à un graphe orienté G	p 193

Première partie

Introduction

1

Fonctions indexées par des graphes

Résumé

Dans ce chapitre, nous introduisons une famille de fonctions sur l'ensemble des diagrammes de Young indexée par des graphes bicolores. Celle-ci est liée aux caractères du groupe symétrique via le théorème 2.7. Nous étudions ensuite certaines relations entre ces fonctions, qui permettent de montrer que les fonctions indexées par les forêts engendrent tout l'espace. Elles ne forment pas une base, mais si on munit un graphe d'une structure de carte étiquetée, la fonction associée a une décomposition canonique comme somme alternée de fonctions de forêts.

1.1 Définitions

1.1.1 Partitions et diagrammes multirectangulaires

Définition 1.1. Une partition λ d'un entier n (notation : $\lambda \vdash n$) est une suite presque-nulle décroissante d'entiers $\lambda_1 \geq \lambda_2 \geq \dots \geq \lambda_r > 0$ dont la somme vaut n .

L'entier n sera appelé poids de la partition et r sa longueur (notation $n = |\lambda|$ et $r = \ell(\lambda)$).

Les partitions peuvent être représentées graphiquement sous la forme d'un diagramme de Young : dans la représentation française, la ligne du bas contient λ_1 cases, celle juste au-dessus λ_2 , *etc.*, toutes les lignes étant alignées à gauche. Un exemple est présenté sur la figure 1.1.

L'ensemble des partitions de taille n ou, de manière équivalente, des diagrammes de Young à n cases sera noté \mathcal{Y}_n . L'ensemble de tous les diagrammes est $\mathcal{Y} = \bigsqcup_n \mathcal{Y}_n$.

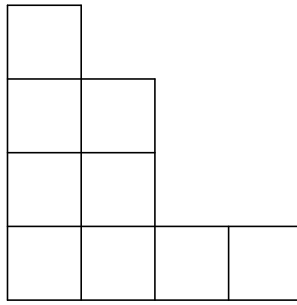
FIG. 1.1 – Diagramme de Young de la partition $(4, 2, 2, 1, 0, \dots)$

Notons qu'un diagramme peut être vu comme un empilement de rectangles : si \mathbf{p} et \mathbf{q} sont deux suites presque-nulles d'entiers positifs avec \mathbf{q} décroissante, on leur associe la partition suivante

$$\lambda(\mathbf{p}, \mathbf{q}) := \underbrace{q_1, \dots, q_1}_{p_1 \text{ times}}, \underbrace{q_2, \dots, q_2}_{p_2 \text{ times}}, \dots \quad (1)$$

Le diagramme de Young correspondant est représenté sur la figure 1.2 dans le cas où $p_i = q_i = 0$ pour $i > 3$.

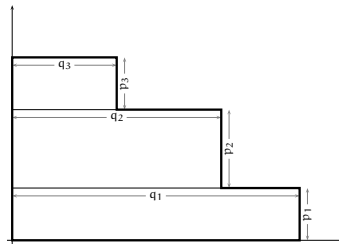

FIG. 1.2 – Diagramme multirectangulaire

Tout diagramme peut être mis sous cette forme (mais pas de manière unique car on n'impose pas que q soit strictement décroissante). Par exemple, le diagramme de la figure 1.2 correspond à

$$p_1 = 1, p_2 = 2, p_3 = 1, q_1 = 4, q_2 = 2, q_3 = 1.$$

Ce type de notation est apparue dans un article de R.P. Stanley ([Sta03]) où il montre que, dans le cas rectangulaire ($p_i = q_i = 0$ pour $i > 1$), le caractère a une expression simple et conjecture une généralisation grâce à ces paramètres.

1.1.2 Graphes bicolores et fonctions associées

Cette thèse présente l'étude de certaines fonctions sur l'ensemble des diagrammes de Young. En particulier, nous allons présenter dans ce paragraphe une famille de fonctions indexées par les graphes bicolores.

Définition 1.2. Un graphe G est dit bicolore si son ensemble V de sommets peut être partitionné en deux sous-ensembles V_\circ (sommets blancs) et V_\bullet (sommets noirs) de telle sorte que toute arête de G ait une extrémité dans V_\circ et l'autre dans V_\bullet .

La figure 1.3 montre un exemple de graphe bicolore.

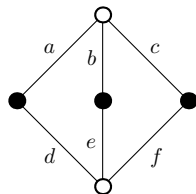

FIG. 1.3 – Exemple de graphe bicolore

Nous allons considérer les *écritures* d'un graphe bicolore G dans un diagramme de Young λ (voir exemple sur la figure 1.4), c'est-à-dire les fonctions de l'ensemble des arêtes de G dans l'ensemble des cases du diagramme λ telles que :

- Si deux arêtes ont la même extrémité *blanche*, leurs images sont dans la même *ligne* du diagramme.
- Si deux arêtes ont la même extrémité *noire*, leurs images sont dans la même *colonne* du diagramme.

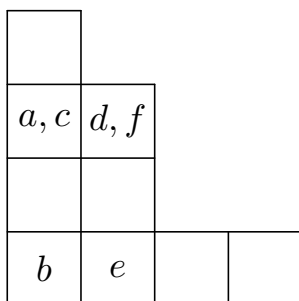

FIG. 1.4 – Exemple d'écriture du graphe de la figure 1.3 dans le diagramme de la figure 1.1

Définition 1.3. Soit λ un diagramme de Young et G un graphe bicolore. Nous noterons $N^\lambda(G)$ le nombre d'écritures de G dans λ . La fonction $\lambda \mapsto N^\lambda(G)$ sera notée $N(G)$.

Étant donné que l'on a défini dans le paragraphe précédent une fonction λ qui associe un diagramme de Young à deux suites presque-nulles d'entiers positifs, nous pouvons composer cette fonction avec $N(G)$. On obtient la formule suivante (voir paragraphe 5.2.2 pour la preuve) :

$$N^{\lambda(\mathbf{p}, \mathbf{q})}(G) = \sum_{\varphi: V_\circ(G) \rightarrow \mathbb{N}^*} \prod_{b \in V_\circ} p_{\varphi(b)} \prod_{n \in V_\bullet} q_{\psi(n)}, \quad (2)$$

où $\psi(n) = \max_{b \text{ voisin de } n} \varphi(b)$. En posant $q'_i = q_i - q_{i+1}$, on restaure la symétrie entre lignes et

colonnes et l'équation devient :

$$N^{\lambda(\mathbf{p}, \mathbf{q})}(G) = \sum_{\substack{\psi: V(G) \rightarrow \mathbb{N}^* \\ \text{admissible}}} \prod_{b \in V_{\circ}} p_{\psi(b)} \prod_{n \in V_{\bullet}} q'_{\psi(n)}, \quad (3)$$

où une fonction $\psi : V(G) \rightarrow \mathbb{N}^*$ est dite admissible si, pour toute arête e de G d'extrémités $b_e \in V_{\circ}$ et $n_e \in V_{\bullet}$, on a :

$$\psi(b_e) \leq \psi(n_e).$$

1.2 Relations

1.2.1 Boucles et transformations élémentaires

Commençons par fixer la terminologie : nous appellerons boucle d'un graphe une suite d'arêtes orientées e_1, e_2, \dots, e_l telle que l'arrivée de e_i et l'origine de e_{i+1} soient égales pour tout $1 \leq i \leq l$ (avec la convention $e_{l+1} = e_1$) et que, mis à part ces conditions, les extrémités des arêtes sont différentes (un exemple est dessiné sur la figure 1.5). Notons qu'une permutation cyclique des arêtes ne modifie pas la boucle.

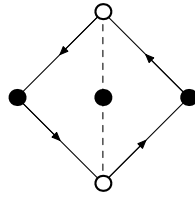

FIG. 1.5 – Exemple de boucle dans un graphe bicolore

Nous pouvons maintenant définir nos transformations élémentaires. Soit G un graphe orienté et L une boucle de G . Notons $E(L)$ l'ensemble des arêtes de la boucle L orientées d'un sommet blanc vers un sommet noir. Définissons alors l'élément $T_L(G)$ du groupe commutatif libre engendré par les sous-graphes de G par la formule suivante :

$$T_L(G) = \sum_{\substack{E' \subset E(L) \\ E' \neq \emptyset}} (-1)^{|E'|+1} G \setminus E' \quad (4)$$

C'est une transformation locale (elle ne modifie pas le graphe hors de la boucle L) : un exemple est présenté sur la figure 1.6.

Nous avons alors la relation suivante entre les $N(G)$ (prouvée au paragraphe 6.2.2) :

Proposition 1.1. *Soit G un graphe et L une boucle de G . Alors,*

$$\forall \lambda \in \mathcal{Y}, N^\lambda(G) = N^\lambda(T_L(G)). \quad (5)$$

Nous conjecturons que toutes les relations entre des fonctions N se déduisent de celles-ci. Formellement :

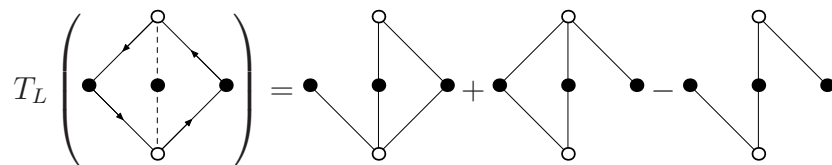
FIG. 1.6 – Exemple de transformation élémentaire T_L

Conjecture 1.2. *On a un isomorphisme d'algèbre*

$$\langle G \rangle / \text{Ker } N \simeq \langle G \rangle / (G - T_L(G)).$$

Cette conjecture est motivée par la remarque page 76.

1.2.2 Une algèbre engendrée linéairement par les forêts

Un corollaire de la proposition précédente est le résultat suivant :

Corollaire 1.3. *L'algèbre $\mathcal{N} = \langle N(G) \rangle$ est engendrée linéairement par les $N(F)$, où F décrit l'ensemble des forêts bicolores.*

Par contre, les $N(F)$ ne sont pas indépendants comme le montre la relation (les deux égalités sont une application de la proposition 1.1) :

$$\begin{aligned} N \left(\begin{array}{c} \circ \bullet \circ \bullet \\ | \quad | \\ \circ \bullet \end{array} \right) &= N \left(\begin{array}{c} \circ \bullet \circ \bullet \\ | \quad | \\ \circ \bullet \end{array} \right) + N \left(\begin{array}{c} \circ \bullet \circ \bullet \\ | \quad | \\ \circ \bullet \end{array} \right) - N \left(\begin{array}{c} \circ \bullet \circ \bullet \\ | \quad | \\ \circ \bullet \end{array} \right) \\ &= N \left(\begin{array}{c} \circ \bullet \circ \bullet \\ | \quad | \\ \circ \bullet \end{array} \right) + N \left(\begin{array}{c} \circ \bullet \circ \bullet \\ | \quad | \\ \circ \bullet \end{array} \right) - N \left(\begin{array}{c} \circ \bullet \circ \bullet \\ | \quad | \\ \circ \bullet \end{array} \right) \end{aligned} \quad (6)$$

L'algorithme suivant \mathcal{A}_0 donne, à partir d'un graphe G une somme alternée de sous-fôrêts de G ayant la même image que G par N .

Donnée un graphe orienté G .

Variable S est une combinaison linéaire formelle de sous-graphes de G .

Initialisation $S = G$.

Étape 1 On choisit une boucle L d'un graphe G' qui n'est pas une forêt et dont le coefficient c_G dans S est non nul.

Étape 2 On applique T_L à G' dans S , c'est-à-dire que l'on pose

$$S := S - c_{G'} G' + c_{G'} \delta(T_L(G')),$$

Fin Si S n'est pas une combinaison linéaire de forêts, retourner à l'étape 1.

Sortie On renvoie S .

Cet algorithme termine mais n'est pas confluent : le résultat dépend des boucles choisies à l'étape 1.

Voici le type de questions que l'on peut alors se poser :

1. Quelle est le coefficient d'une sous-forêt donnée du graphe G ?
2. De manière moins précise, que vaut la somme des coefficients de toutes les sous-forêts isomorphes à une forêt donnée ?
3. Peut-on déterminer le signe des coefficients ?
4. Certaines sous-forêts sont-elles répétées ou tous les coefficients valent-ils 0 ou ± 1 ?

Ces questions sont d'autant plus difficiles que l'algorithme A_0 n'est pas confluent. Toutes les questions ci-dessus se déclinent donc en deux variantes

- a. Pour tout choix de boucles, ... ?
- b. Existe-t-il un choix de boucles tel que ... ?

Le paragraphe suivant présente le seul résultat que l'on a pu établir pour un choix de boucles quelconque, alors que la suite (voir paragraphe 1.3) concerne des questions du deuxième type. Un bon choix de boucles est possible en donnant au graphe une structure de *carte étiquetée*.

1.2.3 Nombre de forêts minimales

Nous dirons qu'une forêt est minimale si tous ses sommets noirs sont dans des composantes connexes distinctes. Déterminer la taille de leurs composantes connexes et leur nombre après itération de transformations du type T_L (problème de type 2b) sur un graphe G est un problème qui apparaît dans l'étude des coefficients des polynômes de Kerov (voir paragraphe 3.3.2.1). Nous allons voir dans ce paragraphe que, même si les forêts ne forment pas une base linéaire de l'algèbre \mathcal{N} , le nombre de forêts minimales d'une taille donnée apparaissant à la sortie de l'algorithme \mathcal{A}_0 ne dépend pas des boucles choisies et peut être calculé facilement à partir de la combinatoire du graphe.

1.2.3.1 Enoncé

Plus précisément, nous pouvons classer les forêts minimales par le nombre de voisins de chacun de leur sommet noir.

Définition 1.4. Soit G un graphe bicolore et $q : V_{\bullet} \rightarrow \mathbb{N}^*$. On appellera q -forêt une forêt minimale de G tel que tout sommet noir $n \in V_{\bullet}$ ait $q(n) - 1$ voisins.

Par ailleurs, un graphe G sera dit q -admissible si

$$\forall A \subset V_{\bullet}, V_G(A) \geq \sum_{n \in A} (q(n) - 1) \quad \text{avec égalité ssi } A \text{ est l'ensemble de sommets noirs d'une union de composantes connexes de } G,$$

où $V_G(A)$ désigne le nombre de sommets blancs de G ayant au moins un voisin dans A .

La somme des coefficients des q -forêts après itération de transformations élémentaires sur un graphe G est donnée par le théorème suivant :

Théorème 1.4 (Problème entre les types 1a. et 2a.). *Soit G un graphe bicolore avec c composantes connexes et $q : V_{\bullet} \rightarrow \mathbb{N}^*$. Quels que soient les choix de boucles effectués dans l'algorithme \mathcal{A}_0 , la somme des coefficients des q -forêts dans le résultat est :*

$$\begin{cases} (-1)^{V_{\bullet}-c} & \text{si } G \text{ est } q\text{-admissible;} \\ 0 & \text{sinon.} \end{cases}$$

Ce théorème, grâce aux résultats du chapitre 6, donne une interprétation combinatoire compacte des coefficients des polynômes de Kerov (théorème 3.8, voir le paragraphe 7.8 pour plus de détails).

Remarque. Une autre manière de voir ce théorème consiste à dire que le nombre de graphes q -admissibles comptés avec la multiplicité $(-1)^{\# \text{ comp. connexes}}$ est invariant par les transformations T_L . C'est donc une quantité bien définie dans l'algèbre $\langle G \rangle / (G - T_L(G))$.

1.2.3.2 Outil : équation de transport

Notons que le théorème 1.4 a une formulation proche du célèbre lemme des mariages de Hall. Rappelons son énoncé :

$$G \text{ contient une } q \text{ forêt} \iff \forall A \subset V_{\bullet}, V_G(A) \geq \sum_{b \in A} (q(b) - 1).$$

Or l'existence d'une q -forêt peut être reformulée comme l'existence d'une solution au système suivant :

$$\begin{array}{ll} \text{Variables} & \{x_e : e \text{ arête de } G\}; \\ \text{Conditions} & x_e \in \{0; 1\}; \\ \text{Équations} & (S) \begin{cases} \forall b \in V_{\circ}, \sum_{\substack{e \text{ arête} \\ \text{d'extrémité } b}} x_e = 1; \\ \forall n \in V_{\bullet}, \sum_{\substack{e \text{ arête} \\ \text{d'extrémité } n}} x_e = q(n) - 1. \end{cases} \end{array}$$

Ce type de système d'équations est connu sous le terme d'équation de transport. En effet, on peut l'interpréter de la façon suivante :

- chaque point blanc est une usine produisant une unité d'une certaine marchandise.
- chaque sommet noir n est un consommateur et veut acheter $q(n) - 1$ unités de cette marchandise.
- chaque arête est une route entre une usine et un consommateur.

La résolution de ce système consiste à trouver un moyen d'acheminer les marchandises produites à leurs acheteurs potentiels.

Il est facile de voir, en utilisant le lemme des mariages, que, si on remplace la condition $x_e \in \{0; 1\}$ par $x_e > 0$, l'existence d'une solution est équivalente au fait que le graphe soit

q -admissible (voir paragraphe 7.1.9 pour la preuve).

Par ailleurs, si L est une boucle du graphe G et $E(L)$ l'ensemble correspondant défini au paragraphe 1.2.1, et (x_e) une solution du système (S) , alors la définition suivante de (y_e) (où t est un réel quelconque) donne une autre solution de (S) :

$$y_e = \begin{cases} x_e & \text{if } e \notin L, \\ x_e + t & \text{if } e \in (L \setminus E(L)), \\ x_e - t & \text{if } e \in E(L). \end{cases}$$

Ceci fait le lien entre notre transformation élémentaire et la q -admissibilité des graphes. Cette remarque est au coeur de la preuve du théorème 1.4 (voir paragraphe 7.8.2).

1.2.4 Graphes non bicolorés et extensions linéaires

Dans ce paragraphe, nous allons regarder des graphes orientés (non bicolorés). Une arête est donc maintenant un couple de demi-arêtes ayant chacune un sommet du graphe pour extrémité : l'extrémité de la première demi-arête est appelée *origine* de l'arête et celle de la seconde sa *fin*. Un exemple de graphe orienté G est donné sur la figure 1.7 (sur les figures, quand c'est possible et sauf mention du contraire, on dessinera toujours l'origine d'une arête à gauche de sa fin).

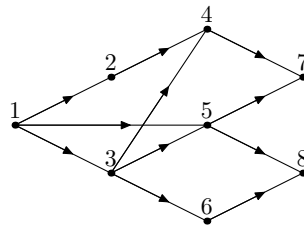

FIG. 1.7 – Exemple de graphe orienté

Les graphes bicolorés sont un cas particulier de graphes orientés : en effet, on peut voir, pour chaque arête, son extrémité blanche comme son origine et son extrémité noire comme sa fin.

1.2.4.1 Généralisation des transformations élémentaires

La définition de boucle est la même dans un graphe orienté que dans un graphe bicoloré (elle ne dépend pas de l'orientation des arêtes dans le graphe). Les arêtes de la boucle ont alors deux orientations :

- leur orientation dans le graphe.
- leur orientation dans la boucle.

Nous ne demandons pas que ces deux orientations coïncident. Par exemple, sur la figure 1.8, bien que seules les arêtes a , b et c aient la même orientation dans le graphe et dans la boucle L (dessinée en trait plein), nous dirons que L est une boucle du graphe orienté G .

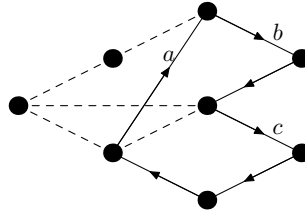

FIG. 1.8 – Exemple de boucle dans un graphe orienté

On note $E(L)$ l'ensemble des arêtes pour lesquelles les deux orientations coïncident (dans l'exemple, $E(L) = \{a, b, c\}$). Cette définition prolonge celle du paragraphe 1.2.1 dans le cas d'un graphe bicolore. Elle permet de prolonger aussi la transformation T_L en utilisant l'équation (4) page 26 (exemple sur la figure 1.9).

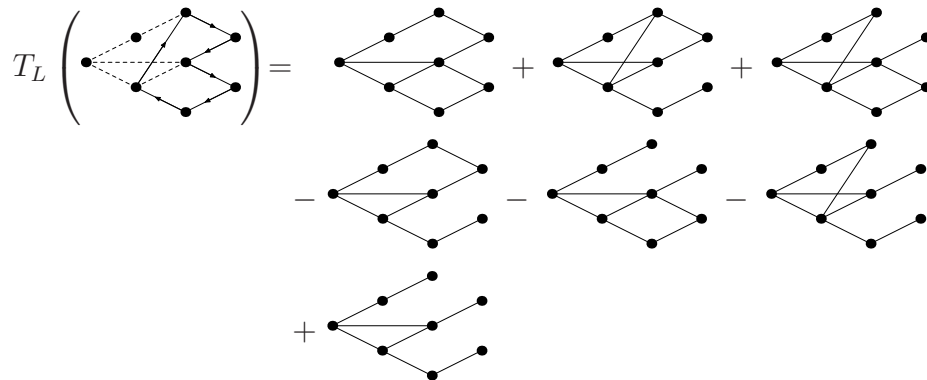

FIG. 1.9 – Exemple de transformation élémentaire sur un graphe orienté

1.2.4.2 Conservation des extensions linéaires

Rappelons que la transformation T_L avait été introduite dans le cas des graphes bicolores car elle laisse N invariant. On peut se demander si il y a un résultat du même type pour des graphes orientés généraux. Nous introduisons pour cela la notion d'extension linéaire.

Définition 1.5. Une extension linéaire d'un graphe orienté G est un mot w dont les lettres sont les sommets de G et tel que :

- chaque lettre apparaît exactement une fois ;
- si v_1 est l'origine d'une arête (*i.e.* l'extrémité de sa première demi-arête) et v_2 sa fin (*i.e.* l'extrémité de sa deuxième demi-arête), alors v_1 est avant v_2 dans le mot w .

L'ensemble des extensions linéaires d'un graphe G sera noté $\mathcal{Ext}(G)$, leur somme formelle $\Phi(G)$:

$$\Phi(G) = \sum_{w \in \mathcal{Ext}(G)} w.$$

L'opérateur Φ peut bien sûr être prolongé par linéarité aux sommes formelles de graphes orientés.

Par exemple, 13526847 est une extension linéaire du graphe de la figure 1.7.

Proposition 1.5. *Soit L une boucle dans un graphe orienté G . On a :*

$$\Phi(T_L(G)) = \Phi(G). \quad (7)$$

Remarque. Cette proposition est prouvée au paragraphe 8.4.1. Elle implique en fait la proposition 1.1. L'idée est de partir de l'équation (3) page 26 et de regrouper les fonctions admissibles selon l'ordre des $\psi(v)$ (celui-ci n'est bien défini que si la fonction ψ est injective ce qui n'est pas systématiquement le cas mais un argument asymptotique, par exemple, permet de se débarrasser de ce problème). La condition d'admissibilité entraîne que cet ordre induit sur les sommets une extension linéaire du graphe. La fonction N peut donc s'écrire comme une composition $N_{\text{ext}} \circ \Phi$ où

$$N_{\text{ext}}(w) = \sum_{\substack{\text{fonctions admissibles} \\ \text{qui induisent l'ordre } w}} \prod_{b \in V_\circ} p_{\psi(b)} \prod_{n \in V_\bullet} q'_{\psi(n)}.$$

Par ailleurs, on peut montrer que toutes les relations entre les sommes formelles d'extensions linéaires de graphe se déduisent de notre proposition (remarque 8.4.1). Malheureusement, ceci ne permet pas de conclure quant à la véracité de la conjecture 1.2 car la preuve fait intervenir des graphes qui ne sont pas nécessairement bicolores, même dans le cas d'une relation entre graphes bicolores.

Mais N n'est pas la seule fonction de la forme $\cdot \circ \Phi$ qui soit intéressante. C. Greene regarde dans son papier [Gre92] une autre fonction de ce type, dont le calcul est simple sur les forêts. La proposition 1.5 est donc intéressante dans ce contexte car elle permet de passer d'un graphe quelconque à des forêts. Ceci est largement exploité dans le chapitre 8.

Nous travaillerons donc dans la suite de ce chapitre avec un graphe orienté quelconque et pas nécessairement bicolore.

1.3 Une décomposition particulière pour les cartes

Dans le paragraphe précédent, nous avons vu que $N(G)$ peut s'exprimer comme une combinaison linéaire formelle de $N(F)$, où les F sont des sous-forêts de G . Mais cette écriture n'est pas unique (voir par exemple l'équation (6) page 27).

Nous allons voir dans cette partie, qu'en donnant à notre graphe une structure de carte étiquetée, nous pouvons trouver une décomposition canonique de la forme ci-dessus. On peut alors calculer le signe des coefficients et même la valeur de certains d'entre eux.

1.3.1 Qu'est-ce qu'une carte ?

1.3.1.1 Carte topologique

On peut dessiner un graphe en représentant chaque sommet par un point et chaque arête par une ligne reliant les extrémités des demi-arêtes la constituant (voir figure 1.10).

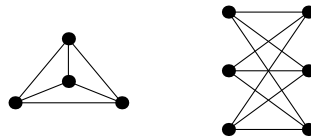

FIG. 1.10 – Dessins de graphes

Si les arêtes ne se croisent qu'au niveau des sommets, le dessin est appelé plongement. C'est le cas du dessin de gauche sur la figure 1.10, mais pas de celui de droite. D'ailleurs, ce dernier (noté $G_{3,3}$) n'admet pas de plongements dans le plan (ou de manière équivalente, sur la sphère).

En revanche, tout graphe admet un plongement dans une surface (supposée bidimensionnelle, connexe, compacte, orientée et sans bord). Ces surfaces sont uniquement déterminées par leur genre à homéomorphisme près (voir figure 1.11).

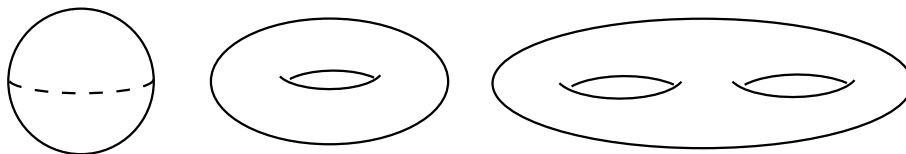

FIG. 1.11 – Surfaces de genre 0,1,2,...

Par exemple, $G_{3,3}$ peut être plongé dans le tore (voir figure 1.12).

Définition 1.6 (Tutte [Tut63]). Une carte (topologique) est un graphe *connexe* G muni d'un plongement i dans une surface S de telle sorte que toutes les composantes connexes de $S \setminus i(G)$ soient homéomorphes à des disques ouverts. Une carte est définie à homéomorphisme de la surface près.

Le plongement est alors dit cellulaire. Les composantes connexes de $S \setminus i(G)$ sont appelées faces de la carte.

Par exemple, le plongement de la figure 1.10 (dessin de gauche), ainsi que celui de la figure 1.12, sont cellulaires. La figure 1.13 montre un autre exemple de carte (avec une seule

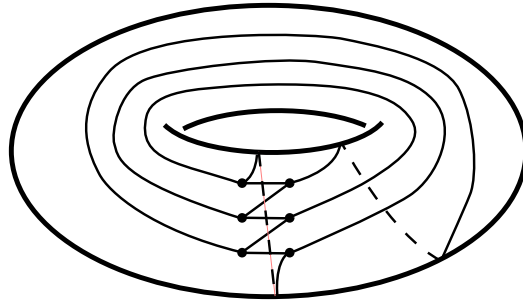
FIG. 1.12 – Un plongement de $G_{3,3}$ dans le tore

face), ainsi qu'un plongement non cellulaire du même graphe. De manière (beaucoup) moins formelle, cette condition technique sert à ce que la surface *ne soit pas inutilement complexe par rapport au plongement du graphe*.

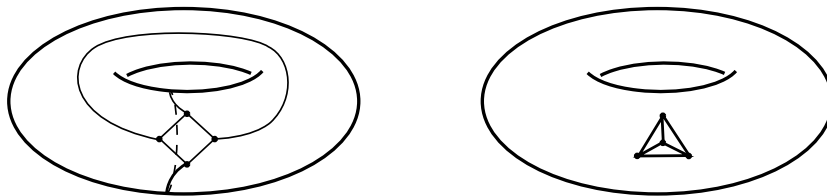

FIG. 1.13 – Exemples de carte (à gauche) et de plongement non cellulaire (à droite)

Notons que tout plongement dans le plan est cellulaire. Cette notion est donc tout à fait adaptée pour étudier les graphes planaires (la motivation de W. T. Tutte était le théorème des quatre couleurs).

Mais les cartes sont un objet plus général car tout graphe admet au moins un plongement cellulaire. Mais ceux-ci ne sont pas tous homéomorphes : la structure de carte est donc plus riche que celle de graphe. Par exemple, les trois cartes de la figure 1.14 sont différentes bien qu'elles aient le même graphe sous-jacent (et que deux d'entre elles aient la même surface).

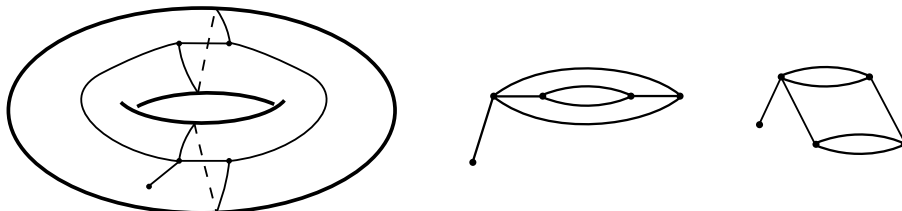

FIG. 1.14 – Trois plongements cellulaires différents du même graphe

Pour finir cette partie topologique, rappelons que le genre de la surface est relié au nombre

$f(C)$ (respectivement $a(C)$ et $s(C)$) de faces (respectivement d'arêtes et de sommets) de la carte par la caractéristique d'Euler de la surface :

$$\chi(C) = 2 - 2g = s(C) - a(C) + f(C) \quad (8)$$

1.3.1.2 Carte combinatoire

Dans le paragraphe précédent, nous avons défini les cartes de manière topologique. Il en existe aussi une définition combinatoire équivalente que nous allons présenter ici et utiliser préférentiellement dans cette thèse.

Notons que, si l'on considère un plongement cellulaire d'un graphe connexe G , l'orientation de la surface permet de définir un ordre cyclique des demi-arêtes ayant pour extrémité un sommet donné. De plus, il est clair que cet ordre est invariant par homéomorphisme de la surface. Il peut donc être défini à partir d'une carte C .

Les deux cartes de droite de la figure 1.14 sont donc différentes car elles n'induisent pas les mêmes ordres cycliques. En fait, cette condition est aussi suffisante (voir par exemple [MT01, Théorème 3.2.4]) :

Définition-Théorème 1.6. *Une carte (combinatoire) est un graphe connexe muni pour chaque sommet d'un ordre cyclique sur les demi-arêtes y arrivant. Cette définition est équivalente à celle de carte topologique du paragraphe précédent (définition 1.6).*

Comme la surface ne joue pas un rôle dominant dans notre travail, nous allons utiliser le plus souvent cette définition de la notion de carte. De plus, pour rendre les figures plus lisibles, nous ferons toujours des dessins de cartes dans le plan qui ne seront pas nécessairement des plongements mais respecteront l'ordre cyclique des demi-arêtes autour d'un sommet (voir par exemple la figure 1.15).

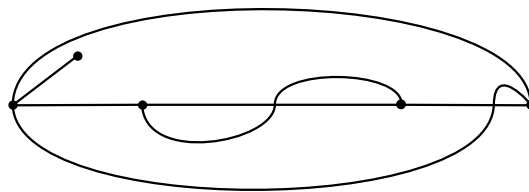

FIG. 1.15 – La carte de gauche de la figure 1.14 dessinée dans le plan

La notion de face peut aussi se retrouver facilement à partir de la définition combinatoire de la carte. Soit C une carte (combinatoire). Notons :

- α l'involution associant à une demi-arête l'autre demi-arête de son arête ;
- σ la permutation des demi-arêtes associant à une demi-arête la suivante dans l'ordre cyclique autour de son extrémité.

Alors les faces de C sont en bijection avec les orbites de l'action de $\sigma \circ \alpha$ sur l'ensemble des demi-arêtes H . Si l'on utilise l'équation (8), on voit que le genre s'obtient facilement à partir de la combinatoire de la carte.

1.3.1.3 Structure additionnelle

Les opérations naturelles sur les graphes peuvent être effectuées sur des cartes : par exemple le fait de retirer un sous-ensemble d'arêtes.

Définition 1.7. Soit C une carte, E l'ensemble de ses arêtes et $E' \subset E$. On définit $C \setminus E'$ comme étant la carte ou l'union disjointe de cartes définie par :

- le même ensemble de sommets que C ;
- $H' = H \setminus (\bigcup E')$ comme ensemble de demi-arêtes ;
- la restriction de la partition en arêtes de H à H' comme partition en arêtes ;
- la restriction de la fonction extrémité à H' ;
- pour la structure de carte, la demi-arête suivante d'une demi-arête $h \in H'$ est la première demi-arête de la suite $\sigma(h), \sigma^2(h), \dots$ appartenant à H' .

Notons que la définition combinatoire des cartes est ici plus pertinente, car si on retire une arête à un graphe G plongé cellulièrement dans une surface, le plongement induit n'est plus nécessairement cellulaire.

Comme dans le cas des graphes, on peut considérer des cartes avec une structure particulière, par exemple :

carte orientée : les arêtes ont une orientation. Dans ce contexte une arête n'est plus un ensemble de 2 demi-arêtes mais un couple.

carte étiquetée : on se donne une bijection de l'ensemble des sommets (ou des arêtes) dans un ensemble d'*étiquettes*.

carte enracinée : on choisit une demi-arête particulière appelée racine.

Pour la dernière définition, nous préférons utiliser, dans ce document, la version équivalente suivante.

Définition 1.8. Une carte enracinée est une carte avec une demi-arête extérieure, c'est-à-dire que la partition de H en arête contient exactement un singleton $\{h_0\}$ et des paires.

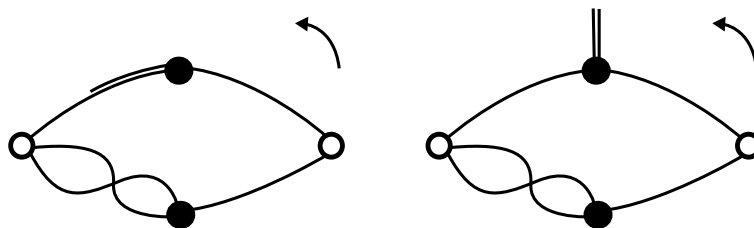

FIG. 1.16 – Exemple de carte bicolore enracinée (avec les deux conventions)

Cette définition est équivalente à celle ci-dessus. La figure 1.16 montre un exemple de carte enracinée dessinée avec les deux conventions. Mais, si C est une carte enracinée (notons h la demi-arête marquée et e l'arête contenant h), la convention à droite a l'avantage de rendre naturelle la structure de carte enracinée induite sur la carte $C \setminus \{e\}$.

1.3.2 Confluence partielle

Dans ce paragraphe, nous allons restreindre les choix de boucles à l'étape 1 de l'algorithme \mathcal{A}_0 de façon à obtenir un algorithme confluent. Pour cela, il faut donner à notre graphe G une structure de carte enracinée.

1.3.2.1 Restriction du choix de boucles

Définition 1.9. Soit C une carte enracinée (non orientée) et $L = \{e_1, \dots, e_l\}$ une boucle de C . L sera dite admissible de type 1 si :

- Elle passe par l'extrémité v_\star de la demi-arête h_0 . Autrement dit, il existe $i \in \{1, \dots, l\}$ tel que v_\star soit l'extrémité de la deuxième demi-arête $h_{i,2}$ de e_i et de la première arête $h_{i+1,1}$ de e_{i+1}
- L'ordre cyclique autour de v_\star induit l'ordre $(h_0, h_{i+1,1}, h_{i,2})$.

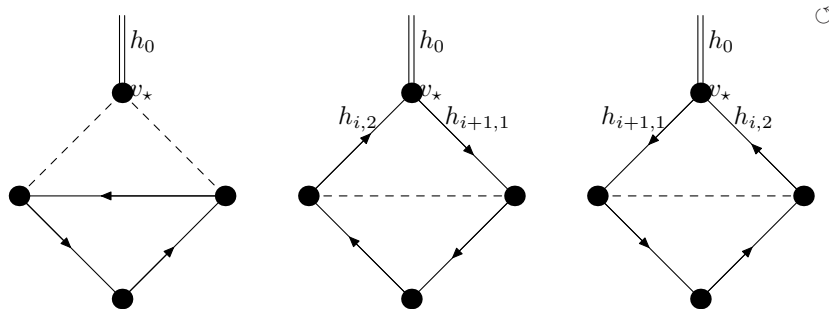

FIG. 1.17 – Seule la troisième boucle est admissible de type 1.

Exemple. La figure 1.17 montre trois exemples de boucles dans une carte enracinée C (les arêtes de la boucles sont en trait plein, les autres arêtes de la carte en pointillé) :

- La première n'est pas admissible de type 1 car elle ne passe pas par v_\star .
- Parmi les deux autres qui passent par v_\star , seule celle de droite vérifie la deuxième condition et est admissible de type 1.

Notons que si une boucle L passe par v_\star , alors L ou \bar{L} est admissible de type 1 (où \bar{L} désigne la boucle L parcourue dans l'autre sens). Ceci implique qu'une carte enracinée C n'ayant pas de boucles admissibles de type 1 n'a pas de boucles passant par v_\star et a donc la forme représentée sur la figure 1.18 : v_\star est relié par exactement une arête à chacune des composantes connexes de $C \setminus \{v_\star\}$ (que nous appellerons pattes).

Notons que chacune des pattes P_i est munie canoniquement d'une structure de carte enracinée : le système de rotation est induit par celui de C et la racine est une des demi-arêtes

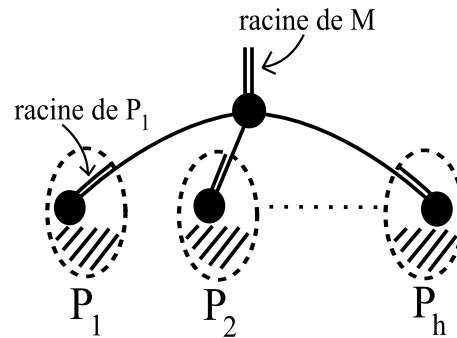

FIG. 1.18 – Forme générale d’une carte enracinée sans boucle admissible de type 1.

de l’arête qui relie P_i à C (voir figure 1.18). Cette remarque permet de définir récursivement la notion de boucle admissible :

Définition 1.10. Soit C une carte enracinée. Les boucles admissibles de C sont (définition récursive) :

- les boucles admissibles de type 1 de C s’il y en a ;
- ou les boucles admissibles des pattes de C si C n’a pas de boucles admissibles de type 1.

Les boucles de la figure 1.19 sont admissibles, bien qu’elles ne soient pas admissibles de type 1. Par contre, les boucles de gauche et du centre dans la figure 1.17 ne sont pas admissibles car elles ne sont pas admissibles de type 1 mais que le graphe contient une telle boucle.

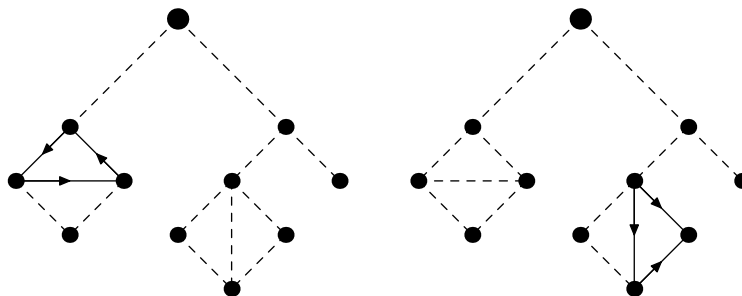

FIG. 1.19 – Exemples de boucle admissible qui ne soit pas de type 1.

Une carte n’ayant pas de boucles admissibles est un arbre (planaire). Notons pour finir que l’orientation des arêtes de la carte ne joue aucun rôle dans cette définition. Celle-ci n’interviendra que quand on appliquera la transformation élémentaire T_L correspondante.

1.3.2.2 Un algorithme confluent

Nous allons maintenant considérer un nouvel algorithme \mathcal{A}_1 qui ressemble à \mathcal{A}_0 mais :

- nous considérons des unions disjointes de cartes enracinées orientées à la place des graphes orientés.

- A l'étape 1, le choix de boucles est restreint au choix d'une boucle admissible d'une des cartes d'une union disjointe dont le coefficient est non nul dans S .

Quand on supprime des arêtes dans une carte, on n'efface jamais la demi-arête extérieure. Si le résultat est connexe, il a donc naturellement une structure de carte enracinée. Par contre dans le cas où on obtient une union disjointe d'au moins 2 cartes, seule la composante contenant v_* a une racine canonique. Ce problème sera réglé de façon différente selon l'objet étudié :

- Dans le cas des identités rationnelles sur les ensembles ordonnés (paragraphe 8.6), la fonction que l'on étudie est nulle sur les graphes non connexes. On oubliera donc simplement les unions disjointes d'au moins 2 cartes.
- Dans le cas de l'étude combinatoire des polynômes de Kerov, les cartes ont des arêtes naturellement étiquetées par des entiers naturels. Une manière d'ajouter une racine à une carte étiquetée n'en ayant pas est de placer la demi-arête extérieure juste après la deuxième demi-arête de l'arête ayant la plus petite étiquette.

Ces détails techniques étant précisés, l'algorithme \mathcal{A}_1 est bien défini.

Proposition 1.7. *L'algorithme \mathcal{A}_1 termine et est confluent.*

Esquisse de la preuve. La terminaison est évidente : le seul point délicat à prouver est la confluence.

Mais comme la transformation est locale, le même type de raisonnement que dans la théorie de réécriture des mots peut être utilisé : il suffit de vérifier que l'algorithme est confluent sur les pics critiques, c'est-à-dire les motifs minimaux sur lesquels on peut effectuer deux opérations différentes.

Ici, les cartes à 2 boucles ($a(C) - s(C) = 1$) jouent le rôle des pics critiques. Il y en a une infinité, mais le calcul est semblable pour des cartes ayant le même *squelette* (i.e. se ramenant à la même carte si on supprime récursivement les sommets de valence 1 et l'arête y arrivant, puis les sommets de valence 2 en recollant les arêtes y arrivant, voir [Oko00, paragraphe 2.3] pour une définition précise). Comme le nombre de squelettes à 2 boucles est fini, il suffit de faire un nombre fini de tests.

Bien entendu, le fait que l'on peut utiliser la théorie de la réécriture et que l'on peut se ramener à un calcul à partir du squelette doit être justifié rigoureusement. La preuve complète est faite dans le paragraphe 6.3 dans le cas des cartes bicolores et est semblable dans le cas général.

□

La combinaison linéaire formelle de sous-forêts de C que l'on obtient est donc bien définie : on la notera $D(C)$ (ou $D_c(C)$ si on a conservé uniquement les arbres). Elle a des propriétés intéressantes, qui ne sont pas communes à toutes les sorties possibles de l'algorithme \mathcal{A}_0 que nous allons détailler dans les deux paragraphes suivants, ce qui permet de répondre à des

questions de type b.

Exemple Nous allons calculer la décomposition de la carte bicolore étiquetée de la figure 1.20. Pour en faire une carte enracinée, nous avons ajouté une demi-arête extérieure juste après la demi-arête d'extrémité noire de l'arête d'étiquette 1, selon la règle énoncée plus haut dans ce paragraphe. Les flèches montrent un exemple de boucle admissible (de type 1) de cette carte.

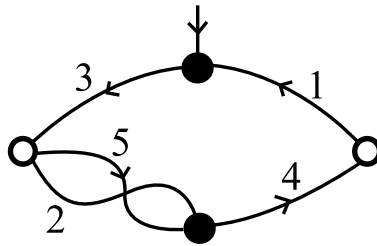

FIG. 1.20 – Une carte bicolore étiquetée avec sa racine et une boucle admissible

Le résultat de la transformation élémentaire par rapport à cette boucle admissible est représenté sur la figure 1.21.

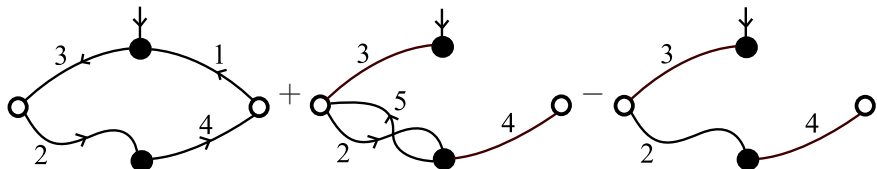

FIG. 1.21 – Résultat de la première transformation élémentaire

La carte de droite est un arbre. Sur les deux autres, nous avons marqué une boucle admissible (de type 1 pour celle de gauche) afin de continuer l'algorithme. Après application des transformations élémentaires correspondantes, on obtient une somme alternée de forêts représentée sur la figure 1.22.

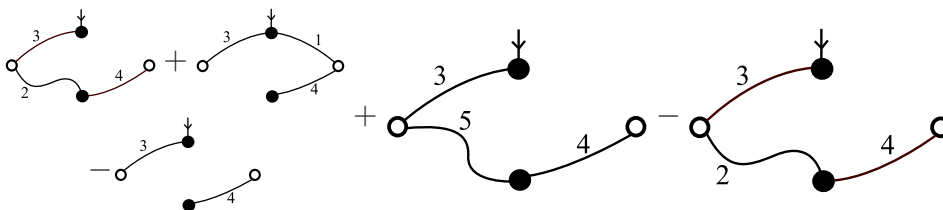

FIG. 1.22 – Après une itération supplémentaire de l'algorithme \mathcal{A}_1

Notons que l'arbre en haut à gauche se simplifie avec celui de droite. Étant donné que nous n'avons plus que des cartes sans boucles, l'algorithme s'arrête ici. La figure 1.23 donne le résultat final.

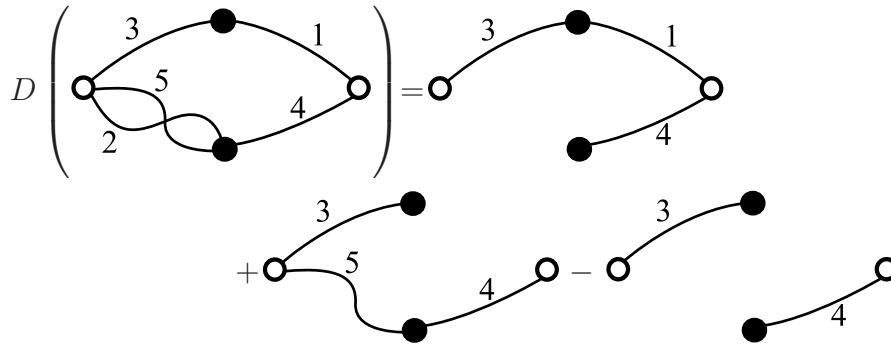

FIG. 1.23 – Résultat final de la décomposition de C .

1.3.3 Signe des différents termes

Les signes des coefficients des sous-forêts dans la décomposition $D(C)$ sont parfaitement déterminés (c'est une réponse positive à la question 3b.) :

Proposition 1.8. *Soit C une carte orientée étiquetée et F une sous-forêt de C . Le coefficient de F dans $D(C)$ a pour signe $(-1)^{\text{nombre de composantes connexes de } F+1}$ (il peut être nul).*

Ce résultat n'est pas une simple conséquence des signes apparaissant dans la définition de T_L (équation (4) page 26). En effet, on peut voir dans l'exemple du paragraphe précédent qu'il y a des simplifications qui apparaissent. La preuve repose sur la confluence de l'algorithme \mathcal{A}_1 : en effet, cela permet de choisir des boucles admissibles en fonction de la forêt F dont on veut déterminer le signe du coefficient (voir paragraphe 6.17).

Dans le cadre de l'étude des polynômes de Kerov, ce résultat est fondamental. En effet, les coefficients des polynômes de Kerov peuvent être interprétés combinatoirement à l'aide d'expressions du type $D(C)$ (paragraphe 3.3.2.1). Ainsi, cette propriété de signe de $D(C)$ permet dans le chapitre 6 de montrer que ces coefficients sont positifs (sans utiliser le théorème 1.4 qui n'a pas un énoncé intuitif). Ce résultat avait été conjecturé par S. Kerov en 2000 ([Ker00], voir aussi [Bia03]) et constitue un des principaux résultats de cette thèse.

Notons qu'avec ce résultat, le théorème 1.4 pour $D(C)$ peut être reformulé :

Théorème 1.9. *Soit C un carte bicolore étiquetée et $q : V_\bullet \rightarrow \mathbb{N}^*$. Alors*

- *Si C est q -admissible, alors il y a exactement une q -forêt de C qui a pour coefficient $(-1)^{|V_\bullet|+1}$ dans $D(C)$, les autres ayant un coefficient nul.*
- *Si non, toutes les q -forêts ont pour coefficient 0 dans $D(C)$.*

Remarquons que les coefficients des forêts minimales d'une carte bicolore C dans $D(C)$ valent 0, 1 ou -1 . Ceci est vrai aussi si la carte est bicolore et la forêt quelconque grâce au lemme 6.19. En regardant la preuve de ce lemme, on peut se défaire de la condition de bicoloriage du graphe. On a donc la proposition suivante :

Proposition 1.10. *Soit C une carte orientée étiquetée. Les coefficients des forêts dans $D(C)$ ne peuvent prendre que les valeurs 0 ou ± 1 .*

1.3.4 Coefficients des arbres

Dans ce paragraphe, nous allons donner explicitement le coefficient d'un arbre couvrant T d'une carte enracinée C dans $D_c(C)$ (ici on a besoin uniquement d'une carte enracinée et pas d'une carte étiquetée car les unions disjointes de cartes ne nous intéressent pas). Au chapitre 8, seuls les coefficients des arbres sont importants puisque la fraction rationnelle associée à un graphe non connexe est nulle (voir corollaire 8.8).

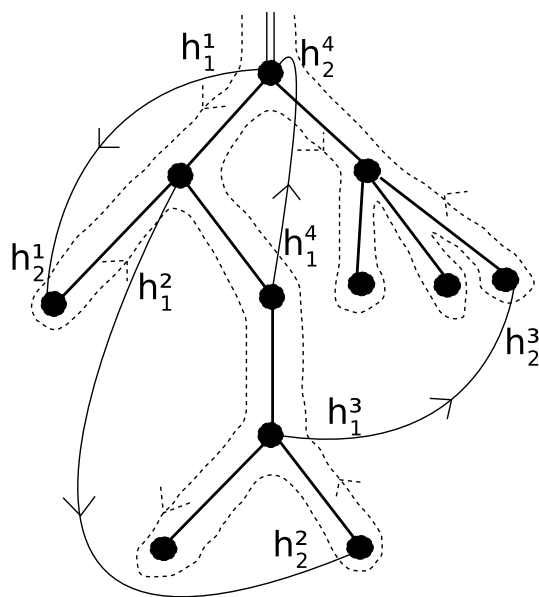

FIG. 1.24 – Exemple de tour d'un arbre couvrant d'une carte enracinée

Pour décrire ces coefficients, nous avons besoin de la notion de tour d'un sous-arbre d'une carte enracinée considérée par O. Bernardi dans [Ber08]. Il s'agit d'un ordre sur les demi-arêtes de la carte n'appartenant pas à l'arbre considéré. Pour l'obtenir, il faut faire le tour de l'unique face de l'arbre T en partant de la demi-arête extérieure et noter, dans l'ordre où on les rencontre, les demi-arêtes des arêtes n'appartenant pas à T . Nous préférons ici une illustration concrète à la définition abstraite et renvoyons le lecteur à l'article précédemment cité pour plus de formalisme. Pour le sous-arbre T (en gras) de la carte C (les arêtes de $C \setminus T$ sont en trait fin) représentée sur la figure 1.24, le tour est donné par $(h_1^1, h_2^1, h_1^2, h_2^2, h_1^3, h_2^3, h_1^4, h_2^4)$.

Les coefficients des arbres dans $D_c(C)$ sont alors donnés par la proposition suivante (démontrée au paragraphe 8.6.3) :

Proposition 1.11. *Soit T un arbre couvrant d'une carte enracinée C . Le coefficient de T dans $D_c(C)$ vaut :*

- 1 si, quelle que soit l'arête $e = (h_1, h_2)$ dans $C \setminus T$, h_1 apparaît avant h_2 dans le tour de T ;
- 0 sinon.

Par exemple, le coefficient de l'arbre de la figure 1.24 dans $D_c(C)$ est +1. Seules les orientations des arêtes n'étant pas dans T jouent un rôle, les orientations des autres arêtes n'ont donc pas été représentées afin d'alléger la figure.

Une conséquence immédiate de ce résultat est une formule combinatoire (théorème 8.17) pour la forme réduite de la fraction rationnelle considérée au chapitre 8. Bien que le problème se formule uniquement en terme de graphes, les munir d'une structure de carte enracinée aide à la résolution.

2

Groupe symétrique et représentations

Résumé

Ce chapitre commence par quelques résultats concernant le groupe symétrique. Nous nous intéressons ensuite à ses représentations et en particulier au calcul du caractère sur une permutation fixée qui peut s'interpréter comme une fonction sur l'ensemble des diagrammes de Young de taille supérieure à un entier donné.

2.1 Structure du groupe symétrique

Définition 2.1. Le groupe symétrique S_n est l'ensemble des permutations de l'ensemble $\{1, \dots, n\}$.

C'est l'exemple le plus simple et le plus naturel de groupe non commutatif. Nous allons présenter quelques-unes de ses propriétés qui sont exploitées dans la suite de ce mémoire. Voici un exemple d'élément de S_5 (on écrit sur la première ligne les éléments de 1 à n et sur la seconde leurs images).

$$\sigma_{\text{ex}} = \begin{array}{c} 12345 \\ 45213 \end{array}$$

2.1.1 Autour de la décomposition en cycles

2.1.1.1 Une base du centre de l'algèbre du groupe symétrique

Soit σ un élément de S_n . On peut regarder la partition $C(\sigma) = \{E_1, \dots, E_r\}$ de $\{1, \dots, n\}$ en orbites sous l'action de σ . Par définition, la permutation σ agit transitivement sur chacun des E_i et induit donc un cycle c_i sur E_i . Le produit (commutatif) des c_i est alors égal à σ . Ceci est appelé la *décomposition en produit de cycles à supports disjoints* de σ . Par exemple,

$$\sigma_{\text{ex}} = (14) \cdot (253).$$

Les longueurs de tous les cycles (y compris des cycles de longueur 1, c'est-à-dire les éléments fixes) peuvent être rangées par ordre croissant pour donner une partition de n appelée type de σ . Par exemple,

$$\text{type}(\sigma_{\text{ex}}) = (3, 2) \vdash 5.$$

Proposition 2.1. *Deux permutations de S_n sont conjuguées si et seulement si elles ont le même type.*

Corollaire 2.2. *Les classes de conjugaison du groupe symétrique S_n sont canoniquement indexées par les partitions de n . Une base du centre de l'algèbre du groupe symétrique S_n est $(C_\lambda)_{\lambda \vdash n}$ où :*

$$C_\lambda = \sum_{\sigma \text{ de type } \lambda} \sigma. \quad (9)$$

Coefficients de connexion et dépendance en n Ceci implique qu'il existe des coefficients $c_{\lambda,\mu}^{\nu;n}$ tels que :

$$\forall \lambda, \mu \vdash n, C_\lambda \cdot C_\mu = \sum_{\nu \vdash n} c_{\lambda,\mu}^{\nu;n} C_\nu$$

Il n'existe pas de formule générale pour ces coefficients, malgré l'abondante littérature sur le sujet. Une des questions naturelles est leur dépendance avec n , lorsque l'on ajoute des parts égales à 1 à trois partitions λ , μ et ν de taille quelconque, c'est-à-dire que l'on regarde :

$$c_{\lambda,\mu}^{\tilde{\nu};n} \text{ avec } \begin{cases} \tilde{\lambda} = \lambda 1^{n-|\lambda|}; \\ \tilde{\mu} = \mu 1^{n-|\mu|}; \\ \tilde{\nu} = \nu 1^{n-|\nu|}. \end{cases}$$

S.V. Kerov et V. Ivanov [IK99] montrent que cette quantité est un polynôme en n . Ils introduisent pour cela une renormalisation de C_λ définie par (attention, leur définition diffère de celle-ci par un facteur multiplicatif indépendant de n) : si $\lambda \vdash k$ et $n \geq k$, on pose

$$a_{\lambda;n} = \underbrace{n(n-1) \cdot (n-|\lambda|+1)}_{|\lambda| \text{ facteurs}} \frac{1}{|C_{\tilde{\lambda}}|} C_{\tilde{\lambda}}, \quad (10)$$

Le coefficient $\frac{n(n-1) \cdot (n-|\lambda|+1)}{|C_{\tilde{\lambda}}|}$ est en fait un polynôme en n de degré $m_1(\lambda)$ (nombre de parts de λ égales à 1). S.V. Kerov et V. Ivanov prouvent alors qu'il existe des coefficients $g_{\lambda,\mu}^\nu$ ne dépendant pas de n , tels que :

$$\forall n, a_{\lambda;n} \cdot a_{\mu;n} = \sum_{\nu \vdash n} g_{\lambda,\mu}^\nu a_{\nu;n}.$$

On peut bien sûr retrouver les $c_{\lambda,\mu}^{\nu;n}$ à partir des g mais il faut faire attention au fait qu'une partition de n a plusieurs antécédants par la fonction $\lambda \mapsto \tilde{\lambda}$. Une preuve plus élémentaire de l'existence des g peut être trouvée dans [Bia03]. Cette renormalisation est très importante dans ce mémoire car elle permet d'écrire des formules indépendantes de n .

2.1.1.2 Permutations et cartes

Prenons maintenant deux permutations σ et τ du groupe symétrique S_n . Nous allons leur associer une carte bicolore ou une union disjointe de cartes bicolors (pour éviter de devoir faire cette précision systématiquement, nous appellerons abusivement maintenant carte un graphe (non nécessairement connexe) muni d'un système de rotations). $M^{\sigma,\tau}$ est définie ainsi :

- Son ensemble de sommets blancs V_\circ est en bijection avec $C(\sigma)$.
- Son ensemble de sommets noirs V_\bullet est en bijection avec $C(\tau)$.
- Ses arêtes sont étiquetées par $\{1, \dots, n\}$. L'arête i a une demi-arête d'extrémité c_σ (où $c_\sigma \in C(\sigma)$ contient i) et une d'extrémité c_τ (où $c_\tau \in C(\tau)$ contient i).
- L'ordre cyclique autour d'un sommet $c \in C(\sigma_i)$ correspond à l'action de c sur les étiquettes des arêtes.

Voici (figure 2.1) la carte associée à la paire $(\sigma_{\text{ex}}, \tau_{\text{ex}})$ où $\tau_{\text{ex}} = (13)(254)$ (rappel $\sigma_{\text{ex}} = (14) \cdot (253)$) :

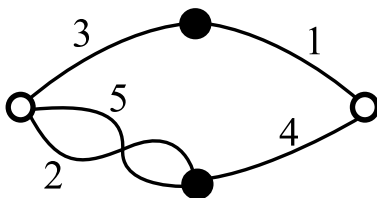

FIG. 2.1 – Exemple de carte associée à une paire de permutations

Si on regarde la carte avec les étiquettes des arêtes mais sans la bijection des sommets avec $C(\sigma) \sqcup C(\tau)$, on peut retrouver facilement le couple de permutations : la décomposition en cycles de σ (respectivement τ) est donnée par l'ordre cyclique sur les arêtes autour des sommets blancs (respectivement noirs).

Cette bijection entre paires de permutations et cartes bicolors dont les arêtes sont étiquetées prolonge une construction de Goulden et Jackson ([GJ92]). Elle a l'avantage que le produit des permutations est facilement lisible sur la carte.

Soit C une carte bicolore étiquetée. Définissons $\mu(C) \in S_n$ de la manière suivante : si $i \in \{1, \dots, n\}$ et h_i la demi-arête de l'arête i ayant une extrémité blanche, $\mu(i)$ est l'étiquette de l'arête contenant $(\sigma_C \circ \alpha_C)^2(h_i)$ (voir paragraphe 1.3.1.2 pour les définitions de σ_C et α_C). Alors :

$$\forall \sigma, \tau \in S_n, \mu(M^{\sigma,\tau}) = \sigma \circ \tau \quad (11)$$

Par ailleurs, pour n'importe quelle carte C , les cycles de $\mu(C)$ sont en bijection avec les faces de C . La décomposition en cycles du produit se lit donc sur les faces de $M^{\sigma,\tau}$.

Si l'on reprend l'exemple de la figure 2.1, on a :

$$\sigma_{\text{ex}} \circ \tau_{\text{ex}} = (1, 2, 3, 4, 5)$$

et la carte correspondante a seulement une face.

2.1.2 Partitions non croisées

Le groupe symétrique est engendré par l'ensemble de ses transpositions $(i, j)_{1 \leq i < j \leq n}$. Cela permet de définir une longueur et un ordre partiel. La forme des intervalles est intéressante car elle fait intervenir un objet combinatoire classique : les partitions non-croisées introduites par G. Kreweras ([Kre72]). Nous verrons dans le paragraphe 2.1.3 que l'ensemble du groupe symétrique admet un recouvrement signé par de tels ensembles.

2.1.2.1 Graphe de Cayley et longueur d'une permutation

Définition 2.2. Le graphe de Cayley d'un groupe G muni d'un système de générateur S (tel que $S^{-1} = S$) est défini de la manière suivante

- Ses sommets sont les éléments du groupe G .
- il y a une arête entre g et g' si $g^{-1} \cdot g'$ est un élément de S

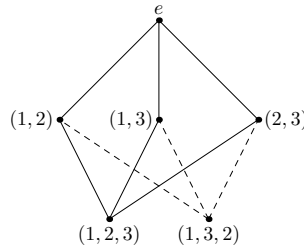

FIG. 2.2 – Graphe de Cayley de S_3 avec les transpositions comme générateurs

La figure 2.2 montre le graphe de Cayley du groupe S_3 (la différence entre les traits pleins et pointillés sera expliquée plus tard). Nous appellerons longueur d'un élément g du groupe la distance entre g et l'élément neutre e dans ce graphe. C'est le nombre minimal de facteurs nécessaires pour écrire g comme produit d'éléments de S .

$$|g| = \min_{\substack{g=s_1 \cdot s_2 \cdot \dots \cdot s_k \\ \forall i, s_i \in S}} k.$$

Il est facile de voir que $|e| = 0$ et que $\forall s \in S, |s| = 1$. De plus, grâce à l'associativité de la loi de groupe, la distance entre 2 points quelconques du graphe est donné par $d(g, g') = |g^{-1} \cdot g'|$. L'inégalité triangulaire implique donc que :

$$|g \cdot g'| \leq |g| + |g'|.$$

Quand il y a égalité, nous dirons que g est inférieur à $g \cdot g'$ ou que g, g' est une factorisation minimale de $g \cdot g'$. Ceci définit un ordre partiel \leq_S sur le groupe G . Si $g \leq_S g'$, on appellera intervalle $[g; g']$ l'ensemble des éléments h tels que $g \leq_S h \leq_S g'$. C'est aussi l'ensemble des éléments situés sur une géodésique (chemin de longueur minimale) entre g et g' . Par exemple, l'intervalle $[e; (1, 2, 3)]$ est représenté en trait plein sur la figure 2.2. L'étude de ces intervalles se ramène au cas où $g = e$ car $[g, g'] \simeq [e, g^{-1}g']$.

2.1.2.2 Factorisation minimale d'un grand cycle

Revenons au cas particulier du groupe symétrique généré par l'ensemble des transpositions. La longueur a ici une expression compacte :

$$|\sigma| = n - |C(\sigma)|. \quad (12)$$

Nous allons décrire les intervalles du type $[e; \pi]$ graphe de Cayley. Commençons par le cas où π est un grand cycle. Les transpositions formant un ensemble stable par conjugaison, nous pouvons supposer que $\pi = (1, \dots, n)$.

Commençons par la remarque suivante : soit $\sigma \in [e; (1, \dots, n)]$, notons $\tau = \sigma^{-1}(1, \dots, n)$, par définition :

$$\begin{aligned} |\sigma| + |\tau| &= |(1, \dots, n)| = n - 1 \\ \text{donc } |C(\sigma)| + |C(\tau)| &= 2n - (n - 1) = n + 1 \end{aligned}$$

La carte $M^{\sigma, \tau}$ a donc $n + 1$ sommets. Or elle a n arêtes et est connexe (car elle n'a qu'une face), c'est donc un arbre. En fait, comme Goulden et Jackson l'ont remarqué dans [GJ92], l'intervalle $[e; (1, \dots, n)]$ ou, de manière équivalente, les factorisations minimales d'un grand cycle sont en bijection avec les arbres planaires bicoloriés avec une arête marquée.

Cet intervalle peut aussi être mis en bijection avec un autre objet combinatoire classique : les partitions non croisées. Il existe une bijection simple entre partitions non croisées et arbres planaires enracinés (tous deux comptés par les nombres de Catalan), on pourrait donc obtenir une bijection avec $[e; (1, \dots, n)]$ par composition, mais il est intéressant de voir que celle-ci a une construction directe très simple.

Définition 2.3. Un croisement d'une partition Π de $\{1, \dots, n\}$ est un quadruplet (a, b, c, d) avec $a < b < c < d$ tel que :

- a et c sont dans la même part de Π .
- b et d sont dans la même part de Π , mais dans une part différente de celle contenant a et c .

Une partition sans croisements est dite non-croisée. L'ordre de raffinement sur les partitions d'un ensemble ($\Pi \leq \Pi'$ si toute part de Π est incluse dans une part de Π') munit, par induction, l'ensemble $NC(n)$ des partitions non croisées de $\{1, \dots, n\}$ d'un ordre partiel.

Moralement, si on place les entiers sur un cercle et que l'on relie entre eux (par l'intérieur) les différents éléments d'une même part, il ne doit pas y avoir de croisements. La figure 2.3 illustre cette définition.

L'ensemble ordonné $NC(3)$ est représenté sur la figure 2.4. Il est facile de voir qu'il est isomorphe à l'intervalle $[e; (1, 2, 3)]$ de S_3 pour l'ordre défini au paragraphe précédent (voir figure 2.2). Ce résultat est en fait général (voir par exemple [Bia97]) :

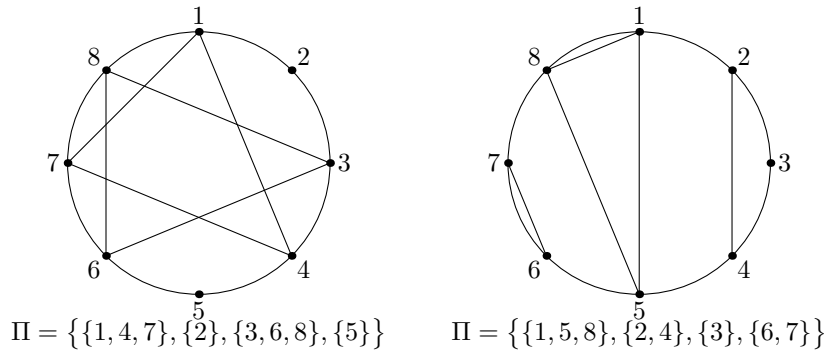

FIG. 2.3 – Seule la partition de droite est non-croisée.

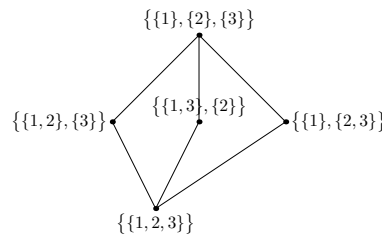

FIG. 2.4 – L'ensemble ordonné $NC(3)$ (plus petit élément en haut)

Proposition 2.3. Soit $n \geq 1$. Notons $\mathcal{P}art(n)$ l'ensemble des partitions de l'ensemble $\{1, \dots, n\}$. L'application

$$\begin{aligned}
 S_n &\longrightarrow \mathcal{P}art(n) \\
 \sigma &\longmapsto C(\sigma)
 \end{aligned}$$

définit un isomorphisme d'ensembles ordonnés entre l'intervalle $[e, (1, \dots, n)]$ et $NC(n)$.

L'application réciproque peut être décrite ainsi : si Π est une partition non croisée de $\{1, \dots, n\}$, son image σ_Π associée à un entier j entre 1 et n appartenant à la part E_i de Π , l'élément qui suit j dans E_i (c'est-à-dire le plus petit élément de E_i strictement plus grand que j s'il existe ou le plus petit élément de E_i sinon). Par exemple, l'image réciproque de la partition de droite de la figure 2.3 est $(1, 5, 8) \cdot (2, 4) \cdot (6, 7)$.

Cette description de l'intervalle $[e, (1, \dots, n)] \simeq NC(n)$ donne en fait une description de tous les intervalles car on peut montrer que si $\pi = c_1 \cdot \dots \cdot c_\ell$ (décomposition en produit de cycles à supports disjoints) est de type λ , alors, en tant qu'ensembles ordonnés, on a :

$$[e, \pi] \simeq \prod_{i=1}^{\ell} [e; c_i] \simeq \prod_{i=1}^{\ell} NC(\lambda_i).$$

2.1.3 Recouvrement du groupe symétrique

Le paragraphe précédent décrit l'ensemble des permutations $\sigma \in [e; (1, \dots, n)]$ ou, autrement dit, l'ensemble des factorisations minimales $\sigma \cdot \tau = (1, \dots, n)$. Nous allons maintenant

nous intéresser à l'ensemble de toutes les factorisations (ou à tout le groupe symétrique si on ne retient que le premier élément).

2.1.3.1 Genre des factorisations

La carte $M^{\sigma,\tau}$ associée à une factorisation de $(1, \dots, n)$ a une seule face. Elle ne peut donc être plane que si c'est un arbre, c'est-à-dire que la factorisation est minimale. En général, cette carte a pour genre :

$$g = \frac{1}{2}(|\sigma| + |\tau| - |(1, \dots, n)|). \quad (13)$$

Nous appellerons abusivement g genre de la factorisation σ, τ ou de la permutation σ .

Plaçons les factorisations du cycle $(1, \dots, n)$ sur un diagramme en fonction des longueurs $|\sigma|$ et $|\tau|$ comme sur la figure 2.5 (où $n = 6$) : chaque point représente l'ensemble des factorisations pour lesquelles le couple $(|\sigma|, |\tau|)$ prend la valeur indiquée. Par exemple le point en haut à gauche correspond à la seule factorisation $(e, (1, \dots, n))$, son voisin aux factorisation $((i, j), (i, j) \cdot (1, \dots, n)), \dots$

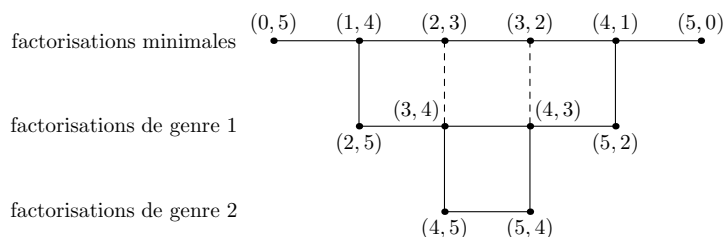

Signification des arêtes :

en trait plein : pour tout élément dans une des deux extrémités de l'arête, on peut trouver un élément dans l'autre auquel il est relié dans le graphe de Cayley.

en pointillé : Il existe deux éléments, un dans chacune des deux extrémités, reliés l'un à l'autre.

FIG. 2.5 – Diagramme des factorisations de $(1, 2, 3, 4, 5, 6)$

Le fait que toutes les arêtes horizontales soient pleines correspond au lemme 5.16. Cela permet de majorer le nombre de permutations ayant un genre donné (voir paragraphe 5.4.2). On ne peut par contre pas toujours remonter dans le diagramme en suivant le graphe de Cayley.

2.1.3.2 Construction du recouvrement

Il n'existe pas, pour les permutations d'un genre donné, de description aussi compacte que celle décrite en genre 0 au paragraphe précédent. Néanmoins, dans le paragraphe 6.4,

nous montrons qu'il existe une famille d'intervalles $[\sigma, \tau]$ avec des multiplicités de telle sorte que :

1. les factorisations $(\sigma, \sigma^{-1}(1, \dots, n))$ et $(\tau, \tau^{-1}(1, \dots, n))$ ont des positions symétriques par rapport à l'axe vertical central dans le diagramme de la figure 2.5. En particulier, toutes les permutations d'un tel intervalle ont le même genre ;
2. le signe d'un intervalle est $+1$ si $(\sigma, \sigma^{-1}(1, \dots, n))$ est sur le bord, -1 si elle est à distance 1 du bord, $+1$ si elle est à distance 2, ... ;
3. Pour toute permutation π , la somme des multiplicités des intervalles auquel elle appartient est égale à 1. On parle de recouvrement signé du groupe symétrique.

Les intervalles auxquels appartient une permutation π sont faciles à déterminer à partir de la décomposition de $C = M^{\pi, \pi^{-1}(1, 2, \dots, n)}$ introduite au chapitre précédent (voir paragraphe 1.3.2.2).

En effet, considérons une forêt F qui apparaît dans $D(M)$ avec un coefficient ε (0 ou ± 1). Prenons par exemple $\pi = (14)(253)$, on a $\pi^{-1}(12345) = (13)(254)$ et la carte C est celle de la figure 2.1. Comme on l'a vu dans l'exemple du paragraphe 1.3.2.2, l'arbre en trait plein sur la figure 2.6 a pour coefficient $+1$ dans $D(M)$.

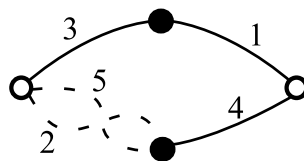

FIG. 2.6 – Carte C contenant un arbre T en trait plein.

On remplace alors chaque composante connexe de F dans la carte C par un polygone ayant deux fois plus d'arêtes en gardant les étiquettes sur une arête sur deux. Ceci peut être fait en conservant l'ordre cyclique autour des sommets. La figure 2.7 illustre ceci dans le cas de l'arbre de la figure 2.6.

Cette nouvelle carte définit un intervalle du groupe symétrique qui apparaît avec la multiplicité ε dans notre recouvrement. Les cartes correspondant à ses éléments sont obtenues en compressant le(s) polygone(s) en arbre(s). Pour avoir le minimum (resp. maximum) de l'intervalle, il faut compresser en un arbre avec un seul sommet noir (resp. blanc). Voici (figure 2.8) dans notre exemple les cartes correspondant aux minimum et maximum de l'intervalle.

Étant donnée une permutation, chaque forêt de $D(C)$ correspond ainsi à un intervalle du recouvrement auquel la permutation appartient (ici $[(2, 5, 3); (1, 2, 5, 3, 4)]$ qui contient effectivement π).

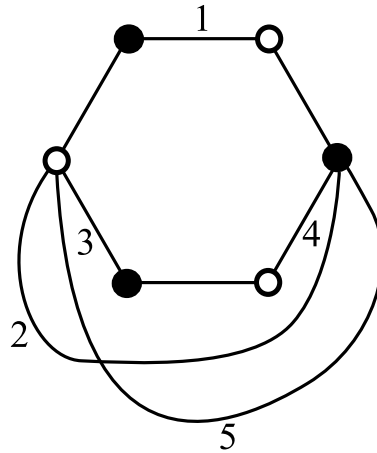

FIG. 2.7 – On remplace l'arbre par un polygone régulier ayant deux fois plus d'arêtes.

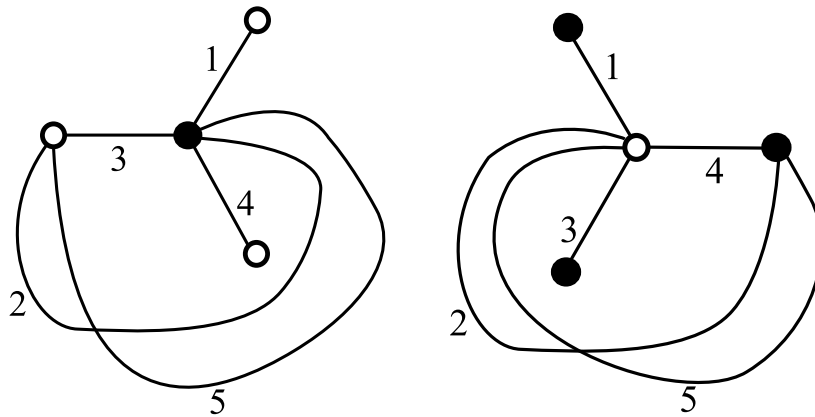

FIG. 2.8 – Cartes correspondant au minimum et au maximum de l'intervalle

Tous les intervalles du recouvrement sont obtenus ainsi. Le lemme 6.19 assure que le coefficient de l'intervalle $[\sigma; \tau]$ ne dépend pas de la permutation π choisie au départ. La somme des coefficients dans $D(C)$ étant 1, on construit bien ainsi un recouvrement signé.

2.1.3.3 Motivation

Ce recouvrement est important dans l'étude des polynômes de Kerov : en effet, l'idée sous-jacente au lemme 3.7 est cette construction. Les coefficients de ces polynômes correspondent aux nombres d'intervalles de taille donnée dans notre recouvrement. L'existence d'un tel recouvrement et ce lien avait été conjecturé par P. Biane ([Bia03]). Nous apportons donc ici une réponse positive à cette conjecture mais malheureusement notre construction n'est pas très explicite (le calcul de $D(C)$ est récursif) : il serait donc intéressant de voir si le théorème 1.4 (qui permet d'éviter la récursivité pour déterminer le nombre de forêts minimales apparaissant) ne permet pas de comprendre certaines propriétés de ce recouvrement.

On peut faire la même chose pour les factorisations d'un élément quelconque du groupe

(pas nécessairement un grand cycle), mais dans ce cas on construit un recouvrement qui n'a pas la propriété 2, à moins de se limiter aux factorisations dont la carte est connexe. De nouveau, la combinatoire de ce recouvrement est liée aux coefficients des polynômes de Kerov généralisés.

2.1.4 Les éléments de Jucys-Murphy

Dans ce paragraphe, nous ne regardons plus des produits de transpositions, mais de certaines sommes formelles de transpositions dans l'algèbre de groupe : les éléments de Jucys-Murphy. Ils ont été définis dans les travaux de A. Jucys ([Juc74]) et G. Murphy ([Mur81]) et jouent un rôle important dans la théorie des représentations du groupe symétrique (voir par exemple [OV96]).

Définition 2.4. Soit $n \in \mathbb{N}$. Pour $i = 1 \dots n$, le i -ième élément de Jucys-Murphy est défini par :

$$\xi_i = \sum_{j < i} (j, i) \in \mathbb{C}[S_n]. \quad (14)$$

Ces éléments engendrent une sous-algèbre commutative maximale du groupe symétrique. L'ensemble des fonctions symétriques en les ξ_i est exactement le centre $Z(\mathbb{C}[S_n])$ de l'algèbre du groupe symétrique. Les fonctions élémentaires ont une expression particulièrement élégante :

$$e_d(\xi_1, \dots, \xi_n) = \sum_{\substack{\sigma \in S_n \\ |C(\sigma)| = n-d}} \sigma. \quad (15)$$

Ce résultat classique peut en fait être affiné légèrement par le lemme suivant, qui est utilisé dans la preuve du théorème 2.7 présentée au chapitre 4.

Lemme 2.4. Soit $n > 0$ et a_1, \dots, a_n des nombres quelconques :

$$(a_1 + \xi_1)(a_2 + \xi_2) \dots (a_k + \xi_k) = \sum_{\sigma \in S_k} \left(\prod_{c \in C(\sigma)} a_{\min(c)} \right) \sigma. \quad (16)$$

Il y a une autre manière de décrire $Z(\mathbb{C}[S_n])$ à partir des éléments de Jucys-Murphy. Considérons

$$\xi_{n+1} = \sum_{j=1}^n (j, n+1) \in \mathbb{C}[S_{n+1}]$$

Cet élément appartenant à $\mathbb{C}[S_{n+1}]$, nous allons avoir besoin de l'application linéaire :

$$\text{proj}_n : \begin{array}{ccc} \mathbb{C}[S_{n+1}] & \longrightarrow & \mathbb{C}[S_n] \\ \sigma \in S_{n+1} & \longmapsto & \begin{cases} \sigma & \text{si } \sigma(n+1) = n+1; \\ 0 & \text{sinon.} \end{cases} \end{array}$$

Cela permet de définir des éléments $\mathcal{M}_n^k = \text{proj}_n(\xi_{n+1}^k)$. Par exemple $\mathcal{M}^1 = 0$ et $\mathcal{M}^2 = n$. Comme proj_n n'est pas un morphisme d'anneau, $\mathcal{M}^{k_1} \cdot \mathcal{M}^{k_2} \neq \mathcal{M}^{k_1+k_2}$ en général.

Les monômes en les \mathcal{M}^k sont alors des éléments du centre de l'algèbre du groupe qui peuvent s'écrire sur la base usuelle des C_λ .

$$\mathcal{M}^k = \sum_{\lambda \vdash n} g_{\lambda,k}^n C_\lambda$$

Comme dans le paragraphe 2.1.1.1, si $\lambda \vdash r$, on peut la compléter en une partition $\tilde{\lambda} = \lambda 1^{n-r}$ pour $r \leq n$. Encore une fois, l'utilisation des $a_{\lambda;n}$ plutôt que des $C_{\tilde{\lambda}}$ permet d'obtenir des expressions avec des coefficients indépendants de n :

$$\mathcal{M}^k = \sum_{r \leq n} \sum_{\lambda \vdash r} g'_{\lambda,k} a_{\lambda;n}, \quad (17)$$

où les $g'_{\lambda,k}$ ne dépendent pas de n . Ce résultat est prouvé par P. Biane dans [Bia03]. Cette formule peut être inversée : il existe un polynôme P_λ tel que :

$$\forall n, a_{\lambda;n} = P_\lambda(\mathcal{M}^2, \mathcal{M}^3, \dots). \quad (18)$$

Remarque. Il est clair que toutes les permutations apparaissant dans \mathcal{M}^k ont la même parité que k . Ceci implique que les partitions λ pour lesquelles $g'_{\lambda,k}$ est non nul vérifient :

$$\sum_i (\lambda_i - 1) \equiv k[2]$$

Cette propriété se conserve en écrivant les $a_{\lambda;n}$ en fonction des \mathcal{M} : la somme des indices d'un monôme dont le coefficient est non nul a toujours la même parité que $|\lambda| + \ell(\lambda)$.

2.2 Théorie des représentations et caractères

Les représentations irréductibles du groupe symétrique S_n sont indexées par les partitions de n . La valeur des caractères sur une permutation donnée définit donc une fonction sur les diagrammes de Young de taille n , dont l'étude est le fil directeur de ces travaux.

Après avoir rappelé quelques résultats sur les représentations irréductibles du groupe symétrique, nous donnons quelques manières de calculer les caractères. La dernière formule (paragraphe 2.2.5) constitue un résultat nouveau et est utilisée dans les chapitres 5, 6 et 7 de cette thèse.

2.2.1 Représentations irréductibles du groupe symétrique

Définition 2.5. Soit G un groupe. On appelle représentation de G sur \mathbb{C} tout couple (V, ρ) où V est un \mathbb{C} -espace vectoriel de dimension finie et ρ un morphisme de G dans $GL(V)$. Une représentation telle que V n'ait pas de sous-espace non trivial stable par tous les $\rho(g)$ est dite irréductible.

Dans le cas où G est fini, toute représentation de G peut être décomposé en somme directe de représentations irréductibles (G est dit semi-simple, théorème de Maschke). Cette

décomposition est alors unique à l'ordre des facteurs près. On s'intéresse donc uniquement aux représentations irréductibles.

Proposition 2.5. *Le nombre de représentations irréductibles (différentes à isomorphisme près) d'un groupe fini G est égal à son nombre de classes de conjugaison.*

Dorénavant, nous considérons uniquement le cas où $G = S_n$. La proposition 2.5 et le corollaire 2.2 impliquent que le nombre de représentations irréductibles de S_n est égale au nombre de partitions $\lambda \vdash n$.

En fait, il existe une bijection canonique entre ces deux objets. Dans le paragraphe 2.2.1.1, nous présentons une construction de la représentation irréductible $(V_\lambda, \rho_\lambda)$ associée à une partition donnée λ (il existe plusieurs constructions qui aboutissent à des représentations isomorphes). Le paragraphe 2.2.1.2 décrit une base de V_λ , ainsi que l'action des éléments de Jucys-Murphy.

Ces résultats sont classiques et peuvent être trouvés dans la vaste littérature sur le sujet (voir par exemple [Sag01]).

2.2.1.1 Projecteur de Young

Soit λ une partition de n . Nous allons construire la représentation irréductible de S_n associée à λ .

Considérons le diagramme de Young associé à λ et remplissons-le de manière quelconque avec une fois chaque nombre de 1 à n (on obtient un tableau T_0 de forme λ). Le groupe symétrique agit naturellement sur l'ensemble des tableaux de forme λ . Une case de T contenant l'entier i contient $\sigma(i)$ dans $\sigma \cdot T$. On peut alors considérer les sous-groupes $L(T_0)$ (respectivement $C(T_0)$) de S_n laissant les lignes (respectivement les colonnes) de T_0 invariantes. Posons :

$$\begin{aligned} a_{T_0} &= \sum_{\sigma \in L(T_0)} \sigma; \\ b_{T_0} &= \sum_{\sigma \in C(T_0)} \operatorname{sgn}(\sigma)\sigma; \\ c_{T_0} &= a_{T_0} \cdot b_{T_0}. \end{aligned}$$

On peut alors montrer qu'il existe un rationnel α_{T_0} tel que :

$$c_{T_0}^2 = \frac{1}{\alpha_{T_0}} c_{T_0}.$$

L'opérateur $p_{T_0} = \alpha_{T_0} c_{T_0}$ est donc un projecteur. L'action du groupe symétrique S_n par multiplication à gauche sur $V_{T_0} = \mathbb{C}[S_n] \cdot p_{T_0}$ définit une représentation de S_n .

Proposition 2.6. *Cette représentation est irréductible et ne dépend (à isomorphisme près) que de la forme λ du tableau T_0 choisi au départ. De plus, si l'on considère deux formes $\lambda \neq \lambda'$, les représentations ainsi construites ne sont pas isomorphes.*

On a ainsi construit à partir d'une partition λ la représentation associée. Il existe d'autres manières de faire cette construction (comme les modules de Specht) qui aboutissent bien sûr à la même représentation. Mais nous avons choisi de présenter celle-ci dans cette thèse car elle est utilisée au paragraphe 5.2.3 pour des calculs de caractère.

2.2.1.2 Base de Young et action des éléments de Jucys-Murphy

On peut décrire combinatoirement une base de l'espace V_λ de la manière suivante :

$$V_\lambda = \bigoplus_{T \in SYT(\lambda)} \mathbb{C}e_T,$$

où la somme parcourt l'ensemble $SYT(\lambda)$ des tableaux standards de forme λ , c'est-à-dire les remplissages du diagramme λ avec les nombres de 1 à n tels que les lignes et les colonnes soient strictement croissantes.

De plus, les éléments de Jucys-Murphy (voir paragraphe 2.1.4) agissent diagonalement sur cette base. Si on appelle contenu de la j -ième case de la i -ième colonne d'un diagramme de Young la quantité $j - i$, la valeur propre de ξ_h sur le vecteur e_T est le contenu $c_h(T)$ de la case du tableau remplie avec la lettre h . Autrement dit,

$$\rho_\lambda(\xi_h)(e_T) = c_h(T)e_T \quad (19)$$

Les éléments de Jucys-Murphy ξ_h sont donc très utiles car :

- Leur expression dans l'algèbre du groupe symétrique est simple ;
- Leur action sur V_λ , et donc leur caractère (et le caractère de polynômes en les ξ_h) sont simples.

2.2.2 Caractères centraux

Pour étudier une représentation (V, ρ) , il est commode de regarder son caractère, c'est-à-dire la fonction :

$$\chi^\rho : \begin{array}{l} G \longrightarrow \mathbb{C} \\ g \longmapsto \text{tr}_V(\rho(g)) \end{array}$$

Cela peut sembler une perte d'information mais :

- La multiplicité d'une représentation irréductible dans une représentation donnée se calcule facilement à partir des caractères. Deux représentations (irréductibles ou non) ayant le même caractère sont donc isomorphes.
- Les constructions usuelles sur les représentations (somme directe, produit tensoriel, induction, restriction) peuvent être traduites facilement sur le caractère.

Le caractère d'une représentation est une forme linéaire sur l'algèbre du groupe. Nous considérerons ici le plus souvent le caractère normalisé $\hat{\chi}^\rho = \chi^\rho / \chi^\rho(1)$. En effet il a l'avantage

de présenter la propriété suivante : si la représentation (V, ρ) est irréductible, sa restriction au centre de $\mathbb{C}[G]$ est un morphisme d'anneau car les éléments du centre $Z(\mathbb{C}[G])$ agissent comme un multiple de l'identité sur V (lemme de Schur).

Ainsi, dans le cas du groupe symétrique, si on note $\mathcal{F}(\mathcal{Y}_n, \mathbb{C})$ l'anneau des fonctions de l'ensemble \mathcal{Y}_n des partitions de taille n dans \mathbb{C} pour la somme et la multiplication point par point, l'application :

$$\begin{aligned} Z(\mathbb{C}[S_n]) &\longrightarrow \mathcal{F}(\mathcal{Y}_n, \mathbb{C}) \\ x &\longmapsto (\lambda \mapsto \hat{\chi}^{\rho_\lambda}(x)) \end{aligned}$$

est un morphisme d'anneau injectif.

Rappelons que nous avons construits dans le paragraphe 2.1.1.1 des suites d'éléments $(a_{\lambda;n})_{n>0}$ (avec $a_{\lambda;n} \in Z(\mathbb{C}[S_n])$) qui engendrent linéairement un espace stable par multiplication. Les images de ces éléments engendrent donc linéairement une sous-algèbre de $\mathcal{F}(\mathcal{Y}, \mathbb{C})$, appelée algèbre des fonctions polynomiales sur les diagrammes de Young (voir [KO94]). On notera donc :

$$\Sigma_\mu : \lambda \mapsto \hat{\chi}^{\rho_\lambda}(a_{\lambda;n}) = |\lambda|(|\lambda| - 1) \dots (|\lambda| - |\mu| + 1) \hat{\chi}^{\rho_\lambda}(\sigma),$$

où σ est une permutation quelconque de type μ (attention au changement de place de λ et μ , le caractère est maintenant vu comme une fonction de λ).

Ces fonctions Σ_μ engendrent linéairement une algèbre que nous noterons Λ^* . Nous étudierons cette algèbre en détail dans le chapitre 3 : graduation, bases intéressantes et formules de changements de bases... Les trois paragraphes suivants donnent différentes formules pour Σ_μ qui seront utilisées dans le chapitre suivant.

2.2.3 Formule de Frobenius

Ce paragraphe concerne le cas où μ est une partition de longueur 1 ($\mu = (k)$). Le caractère central Σ_k peut alors s'exprimer comme le résidu d'une série calculable à partir de la combinatoire du diagramme. Cette formule est due à Frobenius.

Considérons un diagramme de Young λ . Si on tourne le diagramme de 45° vers la gauche et que l'on multiplie les proportions par $\sqrt{2}$ (afin que les points aient des coordonnées entières), le diagramme peut être vu comme une fonction w continue affine par morceaux de pente ± 1 tel que $w(x) = |x|$ pour x suffisamment grand. La figure 2.9 montre cette fonction dans le cas du diagramme de la figure 1.1 (partition 4, 2, 2, 1).

Cette fonction w (et donc le diagramme λ) est entièrement déterminée par ses minima et maxima locaux, c'est-à-dire par deux suites entrelacées $x_0 < y_1 < x_1 < \dots < y_l < x_l$. Considérons alors la fonction :

$$H_\lambda(z) = \frac{\prod_{i=0}^l (z - x_i)}{\prod_{j=1}^l (z - y_j)}.$$

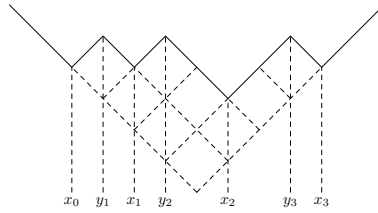
FIG. 2.9 – Représentation du diagramme de Young $(4, 2, 2, 1)$ à la Russe

On peut maintenant énoncer la formule de Frobenius :

$$\Sigma_k(\lambda) = -\frac{1}{k}[z^{-1}]H_\lambda(z)H_\lambda(z-1)\dots H_\lambda(z-k+1). \quad (20)$$

Sous cette formulation, cette formule peut être trouvée dans l'article [Bia03, section 5]. Nous la présentons ici car elle nous permettra de déterminer facilement le terme dominant de Σ_k (voir paragraphe 3.1 où l'on introduit une graduation sur Λ^*). Elle est aussi très pratique pour des calculs analytiques sur les polynômes de Kerov (voir par exemple [GR07]). Tout ceci peut être étendu à des calculs de caractères sur des permutations ayant plusieurs cycles non triviaux (voir [RS08]).

2.2.4 Élément de Jucys-Murphy et moment de la mesure de transition

Les propriétés du paragraphe 2.2.1.2 permettent de calculer immédiatement le caractère sur un polynôme symétrique en les éléments de Jucys-Murphy :

$$\hat{\chi}^{\rho_\lambda}(P(\xi_1, \dots, \xi_n)) = P(\mathbf{C}_\lambda),$$

où \mathbf{C}_λ est la liste des contenus des cases du diagramme λ .

L'action des éléments \mathcal{M}_n^k est plus difficile à comprendre. Comme ce sont des éléments centraux de $\mathbb{C}[S_n]$, ils agissent diagonalement sur chaque V_λ , la question porte donc sur les valeurs propres $M_k(\lambda)$. Par ailleurs, on sait que les valeurs propres de ξ_{n+1} sur une représentation irréductible $V_{\lambda'}$ de S_{n+1} sont les contenus des $n+1$ -ième case des tableaux de forme λ' . Heuristiquement, on peut penser que $M_k(\lambda)$ fait donc intervenir les puissances k -ièmes des contenus des $n+1$ -ièmes cases virtuelles du diagramme λ . Ces cases virtuelles sont les endroits où l'on peut ajouter une case au diagramme λ , leurs contenus sont exactement les x_i .

Ce problème est résolu par P. Biane ([Bia98, proposition 3.3]). Si on note

$$\alpha_i = \frac{\dim(V_{\lambda^{(x_i)}})}{(n+1) \cdot \dim(V_\lambda)},$$

où $\lambda^{(x_i)}$ est le diagramme obtenu en ajoutant une case de contenu x_i à λ , alors

$$M_k(\lambda) = \hat{\chi}^\lambda(\mathcal{M}_n^k) = \sum_{i=0}^l \alpha_i x_i^k = \int_R x^k d\mu, \quad (21)$$

où $d\mu = \sum \alpha_i \delta_{x_i}$. Cette mesure introduite par Kerov est appelée mesure de transition du diagramme λ . Elle est liée avec la fonction H_λ du paragraphe précédent, qui est exactement l'inverse de sa transformée de Cauchy G_λ :

$$G_\lambda(z) = \frac{1}{H_\lambda(z)} = \int_R \frac{1}{z-x} d\mu(x).$$

Rappelons que les \mathcal{M}_n^k s'écrivent comme une combinaison linéaire des $a_{\lambda;n}$ avec des coefficients ne dépendant pas de n (paragraphe 2.1.4). Ceci implique que les M_i sont des combinaisons linéaires de caractères centraux et appartiennent à l'algèbre Λ^* . À nouveau cette formule peut être inversée et on obtient l'expression suivante des caractères :

$$\Sigma_\mu(\lambda) = P_\mu(M_2(\lambda), M_3(\lambda), \dots).$$

L'avantage d'une telle expression par rapport à celle que l'on aurait pu obtenir avec les autres éléments de Jucys-Murphy est la compatibilité des M_i avec des homothéties du diagramme λ (voir paragraphe 3.1.2, où l'on traduit cette propriété en termes d'éléments homogènes).

2.2.5 Une nouvelle formule combinatoire pour le caractère

Les formules des paragraphes précédents pour les valeurs des caractères sont implicites : la première fait intervenir le calcul d'un résidu, la seconde l'inversion d'une matrice dont les coefficients sont décrits de manière combinatoire et pour lesquelles on ne connaît pas de formule close.

Nous donnons dans ce paragraphe une formule combinatoire explicite pour le caractère central Σ_μ dans l'algèbre \mathcal{N} du paragraphe 1.2.2.

Théorème 2.7. *Soient $\mu \vdash k$ une partition. Le caractère central Σ_μ est donné par la formule suivante :*

$$\Sigma_\mu = \sum_{\substack{\tau, \bar{\tau} \in S_k \\ \tau \cdot \bar{\tau} = \sigma}} (-1)^{|C(\sigma)|+|C(\tau)|} N(M^{\tau, \bar{\tau}}), \tag{22}$$

où σ est une permutation de S_k de type μ et les notations N et M sont celles définies aux paragraphes 1.1.2 et 2.1.1.2. L'égalité ci-dessus doit être comprise comme égalité entre fonctions de l'ensemble des diagrammes de Young.

Exemple. Considérons le cas où $\mu = (2)$. On a alors $\sigma = (12)$ qui a 2 factorisations dans S_2 : soit $(\tau, \bar{\tau}) = ((12), \text{Id}_2)$ soit $(\tau, \bar{\tau}) = (\text{Id}_2, (12))$. Les cartes correspondantes sont les suivantes :

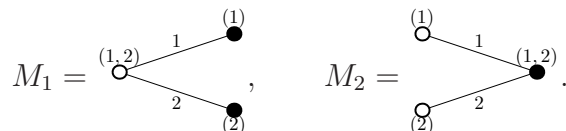

Les fonctions N associées sont très simples (on utilise la notation λ' pour la partition conjuguée de λ) :

$$N^\lambda(M_1) = \sum_i (\lambda_i)^2, \quad N^\lambda(M_2) = \sum_i (\lambda'_i)^2.$$

Notre théorème donne dans ce cas l'expression suivante du caractère :

$$\Sigma_{(2)}(\lambda) = \sum_i (\lambda_i)^2 - \sum_i (\lambda'_i)^2.$$

Le théorème 2.7 constitue un résultat nouveau de cette thèse. Il avait été conjecturé par R. P. Stanley [Sta06] et est prouvé de deux manières différentes dans le chapitre 4 et le paragraphe 5.2.3.

Elle est l'outil principal de l'étude des polynômes de Kerov d'une part (partie III) et des résultats sur le comportement asymptotique des valeurs des caractères du chapitre 5 d'autre part. Le chapitre 3 présente les liens entre ces différents objets.

3

Différentes bases d'une algèbre graduée

Résumé

Dans le chapitre précédent, nous avons introduit une algèbre Λ^* de fonctions sur l'ensemble des digrammes de Young engendrée par les caractères centraux. Nous allons maintenant la munir d'une graduation qui permet de répondre à certains problèmes asymptotiques sur les représentations des groupes symétriques. Pour cela, il est utile d'écrire les caractères centraux en fonction d'éléments homogènes. Les polynômes de Kerov sont une de ces écritures et sont étudiés en détail dans le paragraphe 3.3.

3.1 Une algèbre graduée

Dans ce paragraphe, nous allons définir une graduation sur Λ^* . Ceci sera réalisé en la plongeant dans une algèbre de polynômes (paragraphe 3.1.1). Pour cette graduation, les caractères centraux ne sont pas homogènes ; nous allons décrire au paragraphe 3.1.2 leur composante de plus haut degré. Par ailleurs, cette graduation est liée au comportement asymptotique des valeurs des fonctions sur les diagrammes de Young (paragraphe 3.1.4).

3.1.1 Polynômes de Stanley

Étant donnée une fonction polynomiale sur l'ensemble des diagrammes de Young $F \in \Lambda^*$, nous pouvons considérer sa composée avec l'application définie au paragraphe 1.1.1, qui associe à des suites d'entiers \mathbf{p} et \mathbf{q} un diagramme de Young :

$$(\mathbf{p}, \mathbf{q}) \longmapsto \lambda(\mathbf{p}, \mathbf{q}) \longmapsto F(\mathbf{p}, \mathbf{q}) := F(\lambda(\mathbf{p}, \mathbf{q}))$$

Or le théorème 2.7 et l'équation (2) page 25 montrent que, si F est un caractère central Σ_μ , la fonction ainsi obtenue est un polynôme en \mathbf{p} et \mathbf{q} . Comme Λ^* est engendrée par les Σ_μ ,

ceci est vrai pour toute fonction F .

Ce polynôme est appelé polynôme de Stanley de F : il a été introduit pour les caractères centraux dans l'article [Sta03] mais l'expression explicite du théorème 2.7 n'est établie dans cet article que quand λ est une partition rectangulaire.

Réciproquement, un polynôme en \mathbf{p} et \mathbf{q} n'est pas nécessairement le polynôme de Stanley d'une fonction $F \in \Lambda^*$. Dans le paragraphe 7.4.2, nous établissons des relations nécessaires entre les coefficients, mais la question d'une caractérisation reste ouverte. Ces relations sont utilisées dans le paragraphe 7.7.

Ce plongement de Λ^* dans $\mathbb{C}[\mathbf{p}, \mathbf{q}]$ permet de définir une graduation : un élément est homogène de degré d si son polynôme de Stanley l'est. Notons qu'une multiplication par une même constante c des p et des q consiste à faire une homothétie du diagramme λ , c'est-à-dire multiplier la longueur de chaque ligne par c et recopier c fois chaque ligne (on notera $c \cdot \lambda$ le diagramme obtenu). La définition d'un élément homogène de degré d peut être formulée ainsi :

$$\forall \lambda \in \mathcal{Y}, c \in \mathbb{N}^*, F(c \cdot \lambda) = c^d F(\lambda). \quad (23)$$

Remarque. On pourrait s'intéresser à d'autres graduations de l'algèbre Λ^* : par exemple en utilisant le fait que les caractères centraux s'écrivent aussi comme des polynômes en fonction des coordonnées de Frobenius (voir [KO94]). Ceci donnerait une graduation et une filtration associée différentes sur Λ^* (cet ensemble admet de nombreuses filtrations, voir [IK99]).

3.1.2 Termes de plus haut degré du caractère : les cumulants libres

Dans le chapitre précédent, nous avons introduit deux familles intéressantes dans l'algèbre Λ^* : les caractères centraux Σ_μ et les moments de la mesure de transition M_i . Nous allons calculer leur degré, voir que la seconde est homogène et décrire le terme de plus haut degré de la première, définissant ainsi une nouvelle famille de fonctions polynomiales : les cumulants libres.

Rappelons (voir paragraphe 2.2.4) que les $M_i(\lambda)$ sont les moments de la mesure $d\mu$ dont la transformée de Cauchy est :

$$G_\lambda(z) = \int_{\mathbb{R}} \frac{1}{z-x} d\mu(x) = \sum_{i=0}^{\infty} M_i(\lambda) z^{-i-1} = \frac{\prod_{j=1}^l (z - y_j)}{\prod_{i=0}^l (z - x_i)} = z^{-1} \frac{\prod_{j=1}^l (1 - y_j/z)}{\prod_{i=0}^l (1 - x_i/z)},$$

où les x_i et les y_j sont ceux apparaissant sur la figure 2.9. Ceci implique que les M_i sont des polynômes homogènes de degré i en les x_i et les y_j . Or ceux-ci peuvent s'exprimer facilement comme des combinaisons linéaires de p et de q :

$$x_0 = - \sum_{i=1}^l p_i; \quad y_1 = - \sum_{i=1}^l p_i + q_l; \quad x_1 = - \sum_{i=1}^{l-1} p_i + q_l; \quad \dots$$

Donc les M_i sont des polynômes homogènes de degré i en les variables \mathbf{p} et \mathbf{q} , c'est-à-dire des éléments homogènes de degré i de Λ^* .

Regardons maintenant les caractères centraux Σ_μ . La formule de Frobenius peut se réécrire :

$$\Sigma_k = -\frac{1}{k} [z^{-(k+1)}] \frac{\prod (1 - x_i/z) \cdot \prod (1 - (x_i + 1)/z) \dots \prod (1 - (x_i + k - 1)/z)}{\prod (1 - y_j/z) \cdot \prod (1 - (y_j + 1)/z) \dots \prod (1 - (y_j + k - 1)/z)}.$$

Ceci implique que Σ_k est un polynôme homogène de degré $k + 1$ en les variables

$$(x_i + h)_{\substack{0 \leq i \leq l \\ 0 \leq h \leq k-1}} \text{ et } (y_j + h)_{\substack{1 \leq j \leq l \\ 0 \leq h \leq k-1}}.$$

C'est donc un polynôme *non homogène* de degré $k + 1$ en les x_i et y_j (ou de manière équivalente en \mathbf{p} et \mathbf{q}). Sa composante homogène de degré maximal, que l'on notera R_{k+1} , peut être obtenue en enlevant les décalages dans la formule de Frobenius :

$$R_{k+1}(\lambda) = -\frac{1}{k} [z^{-1}] H_\lambda(z)^k. \quad (24)$$

On reconnaît la formule d'inversion de Lagrange : la série $K(z) = z^{-1} + \sum_{i \leq 1} R_i z^{i-1}$ est l'inverse compositionnel de $G(z)$. Cette construction apparaît dans la théorie des probabilités libres et les R_i sont appelés cumulants libres. Les expressions des R_i en fonction des M_i sont connues et réciproquement (voir paragraphe 3.2.1).

Notons que la formule de Frobenius généralisée de l'article [RS08] permet de la même manière de voir que Σ_μ est un polynôme non homogène de degré $|\mu| + \ell(\mu)$ en les \mathbf{p} et \mathbf{q} , dont la composante de plus haut degré est $\prod R_{\mu_i+1}$.

Les cumulants libres sont apparus pour la première fois dans le livre I.G. Macdonald [Mac95, ex I.2.24] mais leurs lien avec les probabilités libres et les caractères normalisés du groupe symétrique ont été mis en évidence par P. Biane [Bia98].

3.1.3 Graduation de l'algèbre \mathcal{N}

Nous avons introduit une graduation en plongeant Λ^* dans $\mathbb{C}[\mathbf{p}, \mathbf{q}]$. Or, dans le paragraphe 1.1.2, nous avons défini des fonctions $N(G)$ sur les diagrammes de Young qui, bien que n'appartenant pas à l'algèbre Λ^* , peuvent aussi s'écrire comme des polynômes homogènes en \mathbf{p} et \mathbf{q} . On en déduit immédiatement une formule combinatoire pour les cumulants libres semblable au théorème 2.7.

Rappelons, que, si G est un graphe bipartite, la fonction $N(G)$ peut s'écrire ainsi (voir paragraphe 1.1.2) :

$$N^{\lambda(\mathbf{p}, \mathbf{q})}(G) = \sum_{\varphi: V(G) \rightarrow \mathbb{N}} \prod_{b \in V_0} p_{\varphi(b)} \prod_{n \in V_\bullet} q_{\psi(n)}.$$

C'est un polynôme homogène en \mathbf{p} et \mathbf{q} dont le degré est le nombre total de sommets du graphe G . Comme le caractère Σ_μ s'écrit comme une combinaison linéaire de $N(G)$ (théorème

2.7), il suffit de regarder le nombre de sommets des graphes correspondants pour connaître son degré.

Par construction, le graphe sous-jacent à la carte $M^{\tau, \bar{\tau}}$ a $|C(\tau)|$ sommets blancs et $|C(\bar{\tau})|$ sommets noirs. Il faut donc regarder les valeurs possibles de $|C(\tau)| + |C(\bar{\tau})|$ quand $(\tau, \bar{\tau})$ parcourt l'ensemble des factorisations dans $S_{|\mu|}$ d'une permutation σ de type μ . Les résultats (classiques) du paragraphe 2.1.2.2 permettent de répondre immédiatement à cette question : si $\tau \cdot \bar{\tau} = \sigma$, alors

$$|C(\tau)| + |C(\bar{\tau})| \leq n + |C(\sigma)|.$$

avec égalité ssi $(\tau, \bar{\tau})$ est une factorisation minimale de σ (on connaît une description combinatoire de l'ensemble de ces factorisations à base de partitions non croisées). En particulier, on retrouve le fait que Σ_μ est un polynôme non homogène de degré $|\mu| + \ell(\mu)$ et cela donne une nouvelle formule pour la composante de plus haut degré de Σ_k :

$$R_{k+1} = \sum_{\substack{\tau, \bar{\tau} \in S_k \\ (\tau, \bar{\tau}) \text{ factorisation} \\ \text{minimale de } (12\dots k)}} (-1)^{1+|C(\tau)|} N(M^{\tau, \bar{\tau}}) \quad (25)$$

Cette formule sera utilisée dans le paragraphe 3.3.2.1. Une démonstration directe a été donnée par A. Rattan dans [Rat07b].

3.1.4 Interprétation asymptotique de la graduation

La graduation que nous avons introduite est liée au caractère asymptotique des fonctions sur les diagrammes de Young. Ceci est facile à voir sur les fonctions $N(G)$ et les moments. Si λ est un diagramme de Young dont la première ligne et la première colonne ont moins de A cases, alors :

$$\begin{aligned} N^\lambda(G) &\leq A^{s(G)} \\ M_i(\lambda) &\leq A^i \end{aligned}$$

Comme toutes les fonctions polynômiales peuvent s'écrire comme une combinaison de $N(G)$ ou un polynôme en les M_i , chacune de ces deux équations entraîne que :

$$\forall F \in \Lambda^*, \exists C_F \text{ tel que } \forall \lambda \in \mathcal{Y}, F(\lambda) \leq C_F \max(\lambda_1, \lambda'_1)^{\deg(F)} \quad (26)$$

Appliquée au caractère central Σ_μ , cette inégalité devient :

$$\begin{aligned} \forall \mu \in \mathcal{Y}, \exists C_\mu \text{ tel que } \forall \lambda \in \mathcal{Y} (\text{avec } |\lambda| \geq |\mu|), \Sigma_\mu \leq C_\mu \max(\lambda_1, \lambda'_1)^{|\mu| + \ell(\mu)} \\ \iff \hat{\chi}^\lambda(\mu 1^\cdot) \leq C_\mu |\lambda|^{-|\mu|} \max(\lambda_1, \lambda'_1)^{|\mu| + \ell(\mu)} \end{aligned} \quad (27)$$

Dans le cas où $\max(\lambda_1, \lambda'_1) \leq D\sqrt{|\lambda|}$ (par exemple un diagramme de Young *typique* sous la mesure de Plancherel, voir [KV77] et [KV85] avec $D > 2$), on obtient :

$$\hat{\chi}^\lambda(\mu 1^\cdot) \leq C_{\mu, D} |\lambda|^{-\Sigma(\mu_i - 1)/2}$$

Notons que, si on fixe la partition μ , cette borne est optimale à une constante près (voir [Bia98] où P. Biane donne un équivalent de ce caractère). L'avantage de la méthode présentée ici est que l'on peut trouver une généralisation quand la taille de la partition μ varie avec celle de λ (on peut aussi faire varier D). Il suffit pour cela de contrôler le nombre de terme de chaque degré dans l'écriture de Σ_μ comme somme de $N(G)$ (ce qui est fait dans le paragraphe 5.4.2). On obtient ainsi, dans le chapitre 5 de cette thèse, de nouvelles bornes pour les caractères irréductibles du groupe symétrique :

Théorème 3.1. *Il existe une constante $a > 0$ tel que, pour tout diagramme de Young λ ,*

$$|\chi^\lambda(\pi)| \leq \left[a \max \left(\frac{r(\lambda)}{n}, \frac{c(\lambda)}{n}, \frac{|\pi|}{n} \right) \right]^{|\pi|}, \quad (28)$$

où n est le nombre de cases de λ .

Pour établir ce théorème, nous n'avons pas tenu compte des signes apparaissant dans le théorème 2.7. On peut donc espérer obtenir de meilleures bornes en utilisant les polynômes de Kerov (expressions des Σ_μ en fonction des R) dont les coefficients sont positifs (théorème 3.5), en particulier dans le cas où λ est pris au hasard selon la mesure de Plancherel (les cumulants libres, sauf R_2 , sont alors petits). Pour cela, il faut bien connaître les coefficients des polynômes de Kerov (ce qui est l'objectif du paragraphe 3.3). Ceci est pour l'instant à l'état de piste de recherche...

Par ailleurs, nous avons vu que le comportement asymptotique d'un $N(G)$ dépend du nombre de sommets du graphe G . Dans la formule combinatoire du caractère (théorème 2.7), les graphes apparaissant ont une structure de cartes et ont tous le même nombre d'arêtes et de faces. Le comportement asymptotique des termes dépend donc du genre de la carte. Le terme sous-dominant du caractère (correspondant aux cartes de genre 1) peut ainsi être calculé explicitement (voir corollaire 6.9). Ce phénomène, appelé développement topologique, apparaît dans de nombreux domaines (matrices aléatoires, nombre d'Hurwitz, ...) et est utile pour comprendre le comportement asymptotique des objets. Le théorème 3.8 (interprétation combinatoire des coefficients des polynômes de Kerov) peut aussi se lire comme un développement topologique.

3.2 Bases de Λ^*

Dans ce qui précède, nous avons défini plusieurs familles de fonctions polynômiales sur les diagrammes de Young. Les familles suivantes sont en fait des bases linéaires de l'algèbre Λ^* :

- les caractères centraux Σ_μ , quand μ décrit l'ensemble des partitions ;
- la famille des monômes en les M_i (pour $i \geq 2$) ;
- la famille des monômes en les R_i (pour $i \geq 2$) ;

Dans ce paragraphe, nous introduisons deux autres bases (3.2.1 et 3.2.2) puis regardons un des changements de base (3.2.3). Ce point de vue permet d'expliquer certains résultats sur la forme asymptotique de diagrammes de Young (3.2.4).

3.2.1 Une base liée aux polynômes de Stanley

Les fonctions polynômiales Σ_μ et R_l ont une expression combinatoire explicite en tant que polynôme de Stanley (polynôme en \mathbf{p} et \mathbf{q}) : en effet, les deux peuvent s'écrire comme somme alternée de $N(G)$. Mais les $N(G)$ ne sont pas dans l'algèbre et ne peuvent donc pas être exprimés en fonction d'une des bases de Λ^* . Par exemple, on ne peut pas remplacer chaque $N(G)$ en un polynôme en les R_l pour étudier l'expression des Σ_μ en fonction des R_l (c'est-à-dire les polynômes de Kerov, voir paragraphe 3.2.3).

Cet écueil peut être contourné en utilisant une autre base $(S_n)_{n \geq 2}$ de l'algèbre Λ^* définie par :

$$\sum_{i \geq 2} \frac{S_i(\lambda)}{z^n} = \ln(zG_\lambda(z)). \quad (29)$$

On peut obtenir facilement les formules de changement de base avec les R et les M . Une manière de les établir est d'utiliser la théorie des alphabets (que nous ne détaillons pas ici) car, si \mathbb{A} est la différence de l'alphabet des x et de celui des y (voir figure 2.9), on a :

$$\begin{aligned} M_l &= h_l(\mathbb{A}) \\ R_l &= (-1)^l e_l^*(\mathbb{A}) \\ S_l &= \lim_{x \rightarrow 0} \frac{h_n(t\mathbb{A})}{t} \end{aligned}$$

Pour plus de détails, nous renvoyons le lecteur à l'article [Las08c] de M. Lassalle, qui nous a suggéré cette interprétation. Voici les formules obtenues (certaines sont démontrées sans alphabet au paragraphe 7.2) :

$$M_n = \sum_{l \geq 1} \frac{1}{l!} (n)_{l-1} \sum_{\substack{k_1, \dots, k_l \geq 1 \\ k_1 + \dots + k_l = n}} R_{k_1} \cdots R_{k_l}; \quad (30)$$

$$M_n = \sum_{l \geq 1} \frac{1}{l!} \sum_{\substack{k_1, \dots, k_l \geq 1 \\ k_1 + \dots + k_l = n}} S_{k_1} \cdots S_{k_l}; \quad (31)$$

$$R_n = \sum_{l \geq 1} \frac{(-1)^{l-1}}{l!} (n+l-2)_{l-1} \sum_{\substack{k_1, \dots, k_l \geq 1 \\ k_1 + \dots + k_l = n}} M_{k_1} \cdots M_{k_l}; \quad (32)$$

$$R_n = \sum_{l \geq 1} \frac{1}{l!} (-n+1)^{l-1} \sum_{\substack{k_1, \dots, k_l \geq 1 \\ k_1 + \dots + k_l = n}} S_{k_1} \cdots S_{k_l}; \quad (33)$$

$$S_n = \sum_{l \geq 1} (-1)^{l-1} (l-1)! \sum_{\substack{k_1, \dots, k_l \geq 1 \\ k_1 + \dots + k_l = n}} M_{k_1} \cdots M_{k_l}; \quad (34)$$

$$S_n = \sum_{l \geq 1} \frac{1}{l!} (n-1)_{l-1} \sum_{\substack{k_1, \dots, k_l \geq 1 \\ k_1 + \dots + k_l = n}} R_{k_1} \cdots R_{k_l}. \quad (35)$$

L'intérêt de cette nouvelle base réside dans le lemme suivant (voir paragraphe 7.4.1 pour la démonstration) :

Lemme 3.2. *Soit F une fonction polynomiale. Elle peut être vue comme un polynôme en S et un polynôme en \mathbf{p} et \mathbf{q} . Ces deux écritures sont liées par la relation suivante :*

$$\left. \frac{\partial}{\partial S_{k_1}} \cdots \frac{\partial}{\partial S_{k_l}} F \right|_{S_2=S_3=\dots=0} = [p_1 q_1^{k_1-1} \cdots p_l q_l^{k_l-1}] F(\mathbf{p} \times \mathbf{q}).$$

Ceci permet d'obtenir une expression sur une base de l'algèbre à partir d'une écriture comme polynôme de Stanley. Regardons par exemple le cas du caractère central Σ_μ . Si $(\tau, \bar{\tau})$ est un couple de permutation et φ une bijection $C(\tau) \simeq \{1, 2, \dots, |C(\tau)|\}$, en suivant la formule (2) page 25, on définit $\psi : C(\bar{\tau}) \rightarrow \mathbb{N}^*$ par :

$$\psi(c) = \max_{\substack{c' \in C(\tau) \\ c \cap c' \neq \emptyset}} \varphi(c').$$

Notons alors l_i le cardinal de $\psi^{-1}(i)$ et posons :

$$S_{\varphi}^{\tau, \bar{\tau}} = \begin{cases} \prod_{i=1}^{|C(\tau)|} S_{l_i+1} & \text{si } \forall i, l_i \geq 1; \\ 0 & \text{sinon.} \end{cases}$$

On a alors :

$$\Sigma_\mu = \sum_{\substack{\tau, \bar{\tau} \in S_k \\ \tau \cdot \bar{\tau} = \sigma}} (-1)^{|C(\sigma)|+|C(\tau)|} \sum_{\varphi: C(\tau) \simeq \{1, 2, \dots, |C(\tau)|\}} S_{\varphi}^{\tau, \bar{\tau}} \quad (36)$$

3.2.2 Les fonctions de Schur décalées

Dans l'article [OO98a], A. Okounkov et G. Olshanski étudient une autre base de l'algèbre Λ^* : les fonctions de Schur décalées. Leur nom vient du fait qu'elles ont une définition et des propriétés analogues aux fonctions de Schur usuelles.

Définition 3.1. On appelle fonction de Schur décalée s_μ^* la fonction sur l'ensemble des diagrammes de Young définie par :

$$s_\mu^*(\lambda) = \frac{\det((\lambda_i + \ell - i)_{\lambda_j + \ell - j})_{1 \leq i, j \leq \ell}}{\det((\lambda_i + \ell - i)_{\ell - j})_{1 \leq i, j \leq \ell}},$$

où $\lambda = \lambda_1, \lambda_2, \dots, \lambda_\ell$ et $(x)_h = x(x-1)\dots(x-h+1)$.

L'ensemble de ces fonctions (quand μ décrit l'ensemble de tous les diagrammes de Young) forme une base de Λ^* . Outre la transcription de nombreuses propriétés des fonctions de Schur, un des intérêts est l'expression des caractères centraux sur les fonctions de Schur décalées :

Proposition 3.3 ([OO98a]). *Si μ est une partition de k , alors on a :*

$$\Sigma_\mu = \sum_{\nu \vdash k} \chi_\nu(\mu) s_\nu^*.$$

Le caractère sur une permutation dont la taille du support est k dans un groupe symétrique de taille quelconque est ainsi exprimé en fonction de caractères de S_k . Cette propriété est

utilisée dans le chapitre 4 pour démontrer le théorème 2.7.

Les fonctions de Schur décalées apparaissent aussi lors de l'étude des représentations des groupes de Lie classiques. Elles ont été peu étudiées dans cette thèse : il pourrait être intéressant d'essayer de les exprimer en fonction des $N(G)$ ou d'étudier leur polynôme de Stanley.

3.2.3 Polynômes de Kerov

Nous regardons dans ce paragraphe l'écriture de Σ_μ comme polynôme en R (celles en tant que polynôme en S et en tant que combinaison de s_ν^* ont été données dans les paragraphes précédents). La formule de Frobenius permet de faire des calculs pour les éléments de petit degré dans le cas où $\ell(\mu) = 1$ (voir [Bia03, Theorem 5.1]). Voici les premières valeurs :

$$\begin{aligned}\Sigma_1 &= R_2; & \Sigma_4 &= R_5 + 3R_3; \\ \Sigma_2 &= R_3; & \Sigma_5 &= R_6 + 15R_4 + 5R_2^2 + 8R_2; \\ \Sigma_3 &= R_4 + R_2; & \Sigma_6 &= R_7 + 35R_5 + 35R_2 \cdot R_3 + 84R_3.\end{aligned}$$

Ceci a amené S.V. Kerov à formuler la conjecture que tous les coefficients étaient positifs (voir [Bia03]). Dans cette thèse, nous prouvons ce résultat en étudiant la combinatoire sous-jacente.

Théorème 3.4 (conjecture de S.V. Kerov[Ker00]). *Les coefficients du polynôme K_k défini par $\Sigma_k = K_k(R_2, \dots, R_{k+1})$ sont positifs.*

Bien que Σ_μ puisse toujours s'écrire comme un polynôme $K_\mu(R_2, R_3, \dots)$, le résultat de positivité ne subsiste pour $\ell(\mu) > 1$. Par exemple, on a :

$$\begin{aligned}\Sigma_{2,2} &= R_3^2 - 4R_4 - 2R_2^2 - 2R_2; & \Sigma_{3,2} &= R_3 \cdot R_4 - 5R_2 \cdot R_3 - 6R_5 - 18R_3; \\ \Sigma_{2,2,2} &= R_3^3 - 12R_3 \cdot R_4 - 6R_3 \cdot R_2^2 + 58R_3 \cdot R_2 + 40R_5 + 80R_3.\end{aligned}$$

Mais notre résultat se généralise de la manière suivante (conjecturée par A. Rattan et P. Śniady dans [RS08]) :

Théorème 3.5. *Posons*

$$\Sigma'_\mu = \sum_{\substack{\tau, \bar{\tau} \in S_{|\mu|} \\ \tau \cdot \bar{\tau} = \sigma \\ \langle \tau, \bar{\tau} \rangle \text{ agit transitivement sur } \{1, \dots, n\}}} (-1)^{|C(\sigma)| + |C(\tau)|} N^\lambda(M^{\tau, \bar{\tau}}), \quad (37)$$

où σ est une permutation quelconque de $S_{|\mu|}$ de type μ . Alors Σ'_μ est une fonction polynomiale et son expression $\Sigma'_\mu = K'_\mu(R_2, R_3, \dots)$ en tant que polynôme en R n'a que des coefficients positifs.

$$\begin{aligned}\text{Exemples :} \quad \Sigma'_{2,2} &= 4R_4 + 2R_2^2 + 2R_2; & \Sigma'_{3,2} &= 6R_2 \cdot R_3 + 6R_5 + 18R_3; \\ & & \Sigma'_{2,2,2} &= 64R_3 \cdot R_2 + 40R_5 + 80R_3.\end{aligned}$$

Les formules permettant de passer de Σ à Σ' et réciproquement sont faciles (voir paragraphe 6.1.6). Dans le cas où $\ell(\mu) = 1$, toutes les factorisations d'une permutation σ de type $\mu = (k)$ engendrent un sous-groupe transitif de S_k (car il contient le grand cycle σ). On a donc $\Sigma'_{(k)} = \Sigma_{(k)}$. Le théorème 3.5, qui est donc une généralisation de la conjecture de Kerov, est prouvé au chapitre 6. Dans le chapitre 7, nous établissons un résultat plus précis, fournissant ainsi une deuxième preuve. Le paragraphe 3.3 présente les idées directrices de ces preuves.

Remarque. On remarque que le coefficient dans Σ_μ de $\prod_i R_{\mu_i+1}$ est 1 et que tous les autres monômes ont un degré strictement inférieur et de même parité. C'est une conséquence du paragraphe 3.1.2 et de la remarque page 55.

3.2.4 Application : convergence de représentations

Dans ce paragraphe, nous expliquons comment l'utilisation de ces changements de base peut éclairer différemment l'existence d'une forme limite pour un diagramme de Young sous la mesure de Plancherel (résultat obtenu séparément par B.F. Logan et L.A. Shepp [LS77] et S.V. Kerov et A. Vershik [KV77]). Ces idées sont présentes dans les travaux d'Ivanov, Kerov et Olshanski [IO02].

Le problème général se pose de la manière suivante : soit $\rho_n : S_n \rightarrow GL_{N_n}(\mathbb{C})$ une suite de représentations (non irréductibles *a priori*) de S_n . Les exemples classiques sont la représentation régulière où les actions par permutation des composantes sur $(\mathbb{C}^q)^{\otimes n}$. Notons que dans ces deux cas, le calcul du caractère de ρ_n est immédiat ($(\hat{\chi}^{\rho_n}(\sigma) = \delta_{\sigma=\text{Id}_n}$ pour la représentation régulière). On peut décomposer ρ_n en somme de représentations irréductibles. Cela définit une mesure de probabilité $P(\lambda) = \frac{\dim(\lambda) \cdot \text{mult}(\lambda)}{\dim(\rho_n)}$ sur \mathcal{Y}_n et on se demande quelle est la forme limite d'un diagramme pris au hasard selon cette mesure.

Dans le paragraphe 2.2.2, nous rappelons (sans donner la formule précise) que la multiplicité de chaque représentation irréductible dans une représentation donnée peut être calculée à partir des caractères. Malheureusement, quand n devient grand, le calcul est trop complexe pour que cette formule donne une réponse immédiate à la question ci-dessus.

Par contre, nous savons que les cumulants libres sont asymptotiquement proches des valeurs des caractères sur un cycle. Comme celles-ci sont connues et que les cumulants sont directement liés à la forme du diagramme, ce sont de bons outils pour attaquer le problème.

Regardons par exemple le cas de la représentation régulière : on a

$$\Sigma_\mu = \begin{cases} n(n-1) \dots (n-l+1) & \text{si } \mu = 1^l \text{ pour un certain } l; \\ 0 & \text{sinon.} \end{cases}$$

La graduation de l'algèbre Λ^* se lit alors sur le comportement asymptotique :

$$\forall F \in \Lambda^*, \exists A_F \text{ tel que } \forall n, \mathbb{E}_P(F) \leq A_F n^{\deg(F)/2} \quad (38)$$

Nous utilisons maintenant que

$$\prod_{i=1}^{\ell} R_{j_i} = \Sigma_{j_1+1, j_2+1, \dots, j_{\ell}+1} + \text{termes de plus petit degré.}$$

On en déduit que :

$$\mathbb{E}_P(R_j) = \begin{cases} n & \text{si } j = 2; \\ O\left(n^{\frac{j-1}{2}}\right) & \text{sinon.} \end{cases}$$

Ceci montre que les $R_j(\lambda/\sqrt{n})$ tendent en moyenne vers la suite $1, 0, 0, \dots$ (où λ/\sqrt{n} est le diagramme de Young *virtuel* obtenu en faisant une homothétie de centre (O, O) et de rapport $1/\sqrt{n}$). Or la suite $1, 0, 0, \dots$ est la suite des cumulants libres d'une unique mesure qui correspond à un diagramme de Young *virtuel* w (qu'on ne calculera pas ici). Pour obtenir la convergence en probabilités des cumulants (qui entraînera celles des fonctions affines par morceaux associées au diagramme au paragraphe 2.2.4), il suffit de vérifier que leur variance tend vers 0. Or

$$\begin{aligned} \text{Var}_P(R_j/\sqrt{n}) &= \frac{1}{n^j} (E_P(R_j^2) - E_P(R_j)^2) \\ &= \frac{1}{n^j} (E_P(\Sigma_{j-1, j-1}) - E_P(\Sigma_{j-1})^2 + \text{termes de plus petit degré}) \\ &= n^{j-2} \left[\chi^{\rho}((1 \ 2 \dots j-1)(j-2 \ j \dots 2j-2)) - \chi^{\rho}((1 \ 2 \dots j-1))^2 \right] + O(n^{-1}) \quad (39) \end{aligned}$$

Cela tend bien vers 0 dans le cas de la représentation régulière.

Notons que le raisonnement peut être généralisé : si ρ_n est tel que l'équation (38) soit vérifiée pour les caractères centraux et que le membre de droite de (39) tend vers 0, alors il y a convergence des diagrammes vers une forme limite dont on peut calculer facilement les cumulants libres à partir des valeurs des caractères. On retrouve ainsi un résultat de P. Biane (voir [Bia01a]). En regardant les moments d'ordre supérieur, on peut montrer dans certains cas que les fluctuations des cumulants autour de leur valeur limite sont gaussiennes (voir [IO02, Śni06b]).

Comme dans le cas des matrices aléatoires, si on arrive à comprendre le comportement des moments de la mesure de transition quand l'ordre varie avec la taille du groupe n , on pourra en déduire des résultats sur les fluctuations de la longueur des plus longues lignes et/ou des plus longues colonnes (comme le fait A. Okounkov pour la mesure de Plancherel [Oko00]). Ceci permettrait de voir si on a un résultat d'universalité de ces fluctuations avec des arguments semblables à ceux de A. Soshnikov pour les matrices aléatoires [Sos99].

Pour pouvoir obtenir ce type de résultats, il faut bien connaître les coefficients des formules de passage entre caractères et moments ou cumulants. Dans cette optique, le paragraphe suivant est dédié à l'étude détaillée des polynômes de Kerov.

3.3 Étude des coefficients des polynômes de Kerov

Après avoir décrit l'algèbre et ses différentes bases, nous allons regarder précisément une des formules de passage, à savoir l'expression des Σ_μ en fonction des éléments homogènes R_l . La positivité des coefficients dans le cas $\mu = (k)$ observée et conjecturée par S.V. Kerov laisse supposer une riche structure sous-jacente. Un des principaux résultats de cette thèse a été de comprendre les aspects combinatoires de ce problème (paragraphe 3.3.2) et de prouver ainsi la conjecture de Kerov. Avant de développer cette question, nous allons rappeler comment ces coefficients peuvent être calculés par une approche plus analytique.

3.3.1 Calcul des coefficients

Dans ce mémoire, nous avons démontré l'existence des polynômes de Kerov de la manière suivante (qui suit celle de P. Biane [Bia03]) :

1. les projetés \mathcal{M}_n^k dans $\mathbb{C}[S_n]$ des puissances du $n + 1$ -ième éléments de Jucys-Murphy peuvent s'écrire comme une combinaison linéaires des $a_{\lambda;n}$ dont les coefficients ne dépendent pas de n (paragraphe 2.1.4). En inversant la formule, on exprime les $a_{\lambda;n}$ comme polynôme en les \mathcal{M}_n^k .
2. En appliquant les caractères irréductibles, cela donne une expression du caractère central en fonction des M_i (paragraphe 2.2.4).
3. Les M_i peuvent s'exprimer en fonction des R_i .

Cette manière de présenter les choses permet de clarifier les liens avec le centre du groupe symétrique et l'importance d'expressions ne dépendant pas de n , mais ne donne pas un algorithme de calcul très efficace.

Une meilleure méthode pour calculer effectivement les coefficients des polynômes de Kerov dans le cas où $\mu = (k)$ est d'utiliser la formule de Frobenius pour les caractères centraux (paragraphe 2.2.3) :

$$\Sigma_k(\lambda) = -\frac{1}{k} [z^{-1}] H_\lambda(z) H_\lambda(z-1) \dots H_\lambda(z-k+1).$$

En effet, cette formule permet un calcul rapide des coefficients de Σ_k écrit comme polynôme en fonction des coefficients B_l du développement de $H(z)$. La même chose est vrai pour les R_j qui s'écrivent :

$$R_j = -\frac{1}{j-1} [z^{-1}] H_\lambda(z)^{j-1}.$$

Or l'expression des R_j en fonction des B_l peut être inversée, ce qui permet d'exprimer Σ_k en fonction des R_j . Cet algorithme permet de calculer de manière efficace les premières valeurs des polynômes de Kerov.

On peut améliorer cette technique de calcul grâce aux travaux de I.P. Goulden et A. Rattan [GR07]. Ils déduisent en effet de la formule de Frobenius une formule explicite du

caractère central sur un cycle en fonction de variables auxiliaires :

$$C_l = \frac{l(l-1)(l+1)}{24} \sum_t \sum_{\substack{j_1, j_2, \dots, j_t \geq 2 \\ j_1 + j_2 + \dots + j_t = l}} R_{j_1} \cdot R_{j_2} \cdot \dots \cdot R_{j_t}.$$

Cette formule, démontrée de manière plus simple dans [Bia07], permet une grande exploration numérique des polynômes de Kerov. Outre la conjecture de positivité de Kerov, résolue dans le chapitre 6, l'exploration numérique fait apparaître de nombreuses régularités non prouvées pour le moment : la positivité des coefficients de $\Sigma_k - R_{k+1}$ comme polynôme en les C_l d'une part et une conjecture de M. Lassalle d'autre part [Las08d].

Bien qu'il existe une formule de Frobenius dans le cas où $\ell(\mu) > 1$ permettant de calculer efficacement les coefficients, les remarques du paragraphe précédent ne se généralisent pas. De plus, même dans le cas $\ell(\mu) = 1$, il n'existe pas de preuve de la positivité des coefficients partant de ces formules.

3.3.2 Approche combinatoire

Nous avons donc utilisé une autre approche dans cette thèse. L'outil principal n'est plus la formule de Frobenius mais la formule combinatoire donnée au paragraphe 2.2.5. Un indice du fait qu'elle est adaptée à l'étude des polynômes de Kerov est que l'on peut retrouver facilement l'interprétation combinatoire des coefficients des monômes de degré 1 en R proposée par P. Biane (voir [Bia03, théorème 6.1] pour le cas $\ell(\mu) = 1$) :

Proposition 3.6. *Le coefficient de R_{l+1} dans K_μ est égal au nombre de factorisations $(\tau, \bar{\tau})$ d'une permutation σ donnée de type μ dans $S_{|\mu|}$ tels que $|C(\tau)| = 1$ et $|C(\bar{\tau})| = l$.*

Preuve (voir [RS08], théorème 19). Il suffit de regarder les coefficients de $p_1 \cdot q_1^l$ en utilisant les formules (2) page 25, (22) page 60 et (25) page 66 ;

dans Σ_μ : Il est égal au nombre de factorisations $(\tau, \bar{\tau})$ de σ tels que $|C(\tau)| = 1$ et $|C(\bar{\tau})| = l$.

dans R_j : Il est égal à 1 si $j = l + 1$ et 0 sinon.

dans un produit non trivial de R_j : Il est égal à 0. □

Ce raisonnement ne peut pas se généraliser au cas du coefficient d'un monôme de degré quelconque en R immédiatement. Dans les deux prochains paragraphes, nous exposons deux méthodes différentes pour y arriver.

3.3.2.1 Interprétation en termes de cartes

Dans ce paragraphe, nous présentons les grandes lignes de la preuve à base de cartes de l'interprétation combinatoire générale des coefficients des polynômes de Kerov. L'idée centrale est d'exprimer les différentes fonctions polynômiales grâce aux $N(G)$ et d'utiliser leurs relations.

Les résultats que nous allons utiliser ont été représentés schématiquement sur la figure 3.1.

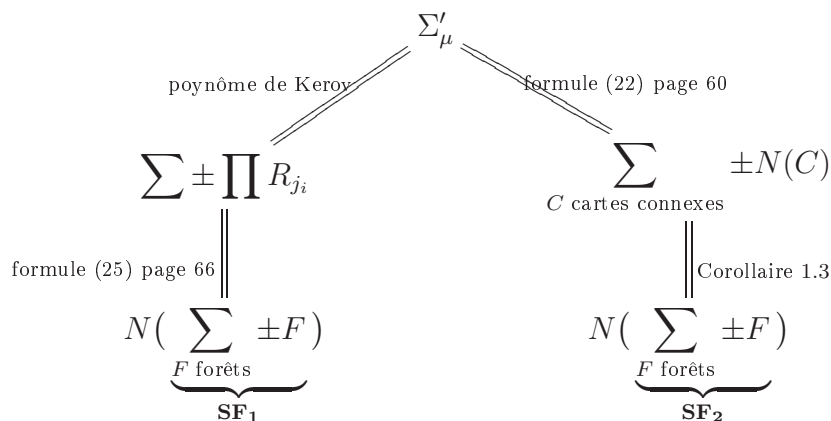

FIG. 3.1 – Différentes expressions du caractère central.

L'égalité en bas à droite peut être obtenue en itérant la proposition 1.1 ($N(G) = N(T_L(G))$) avec n'importe quel choix de boucles. Mais, étant donné que nous travaillons avec des cartes, il existe une manière canonique d'écrire $N(C)$ comme somme alternée de $N(F)$ (en utilisant que $N(C) = N(D(C))$, voir paragraphe 1.3 pour la construction de $D(C)$).

Par ailleurs, nous avons vu dans le paragraphe 1.2.2 que les $N(F)$ ne sont pas linéairement indépendants. L'égalité $N(\mathbf{SF}_1) = N(\mathbf{SF}_2)$ n'entraîne donc pas automatiquement $\mathbf{SF}_1 = \mathbf{SF}_2$.

Lemme 3.7. *Si l'égalité en bas à droite est obtenue en remplaçant $N(C)$ par $N(D(C))$, alors*

$$\mathbf{SF}_1 = \mathbf{SF}_2.$$

Ce lemme est assez technique. Il est prouvé dans le paragraphe 6.4. L'idée sous-jacente est la construction du recouvrement signé du groupe symétrique par des produits d'ensembles de partitions non-croisées décrit au paragraphe 2.1.3. Le lien entre ces deux objets est facile à décrire heuristiquement car :

$$\Sigma_\mu = \sum_{S_{|\mu|}} \pm N(\dots); R_{l+1} = \sum_{NC(l)} \pm N(\dots).$$

Ces formules suggèrent l'interprétation d'une formule du type $\Sigma_\mu = \sum \pm \prod R_{j_i+1}$ comme un recouvrement signé de $S_{|\mu|}$ par des $\prod NC(j_i)$ (une telle interprétation avait été conjecturée par P. Biane [Bia03, section 7]; elle est prouvée dans cette thèse).

Ce lemme est très important pour l'étude des polynômes de Kerov car les coefficients de ces polynômes peuvent être retrouvés facilement connaissant \mathbf{SF}_1 : en effet, une forêt

minimale donnée apparaît dans un seul monôme en les R (rappel : les forêts minimales sont celles qui ont un seul sommet noir par composante connexe). Si on note T_j l'arbre avec un sommet noir relié à $j - 1$ sommets blancs ($j \geq 2$) et $F_{j_1, \dots, j_t} = \bigsqcup_i T_{j_i}$, alors en utilisant la formule (25) page 66, on a :

$$R_{j_1} \cdot \dots \cdot R_{j_t} = N(F_{j_1, \dots, j_t}) + N(\text{forêts non minimales})$$

Le coefficient de $R_{j_1} \cdot \dots \cdot R_{j_t}$ dans Σ'_μ est donc celui de F_{j_1, \dots, j_t} dans \mathbf{SF}_1 .

En utilisant le lemme, on obtient que c'est le coefficient de F_{j_1, \dots, j_t} dans :

$$\sum_{\substack{\tau, \bar{\tau} \in S_{|\mu|} \\ \tau \cdot \bar{\tau} = \sigma \\ \langle \tau, \bar{\tau} \rangle \text{ agit transitivement sur } \{1, \dots, n\}}} (-1)^{|C(\sigma)| + |C(\tau)|} D(M^{\tau, \bar{\tau}}).$$

En appliquant la proposition 1.8 (qui donne le signe des coefficients dans les $D(C)$), cela prouve le théorème 3.5 (tous les détails sont donnés au chapitre 6).

Notons par ailleurs qu'on retrouve les coefficients des polynômes de Kerov uniquement à partir des coefficients des forêts minimales (les autres répètent la même information : en effet, n'importe quelle combinaison de $N(G)$ ne peut pas s'écrire comme un polynôme en R). Or il s'agit justement des coefficients donnés par le théorème 1.4. Ce théorème permet, avec la démonstration ci-dessus de donner une interprétation combinatoire explicite des coefficients du polynôme de Kerov :

Théorème 3.8. *Soit μ une partition et s_2, s_3, \dots une suite d'entiers presque-nulle. Le coefficient de $R_2^{s_2} R_3^{s_3} \dots$ dans l'expression de Σ'_μ (légère déformation du caractère central Σ_μ) est égal au nombre de triplet (σ_1, σ_2, q) avec les propriétés suivantes :*

- (a) τ_1, τ_2 est une factorisation dans $S_{|\mu|}$ d'une permutation σ donnée de type μ .
- (b) le nombre de cycles de τ_2 est égal au nombre de facteurs dans le produit $R_2^{s_2} R_3^{s_3} \dots$; c'est-à-dire $|C(\tau_2)| = s_2 + s_3 + \dots$;
- (c) le nombre de cycles de τ_1 et τ_2 est égal au degré du produit $R_2^{s_2} R_3^{s_3} \dots$; c'est-à-dire $|C(\tau_1)| + |C(\tau_2)| = 2s_2 + 3s_3 + 4s_4 + \dots$;
- (d) $q : C(\tau_2) \rightarrow \{2, 3, \dots\}$ est un coloriage des cycles de τ_2 tel que chaque couleur $i \in \{2, 3, \dots\}$ soit utilisée exactement s_i fois (de façon moins formelle, à chaque cycle de τ_2 on associe un facteur du produit $R_2^{s_2} R_3^{s_3} \dots$) ;
- (e) pour tout sous-ensemble A non trivial (i.e., $A \neq \emptyset$ and $A \neq C(\sigma_2)$) de $C(\sigma_2)$, il y a au moins $\sum_{i \in A} (q(i) - 1) + 1$ cycles de σ_1 dont le support intersecte $\bigcup A$.

Remarque. Si la conjecture 1.2 était vraie, la remarque page 29 impliquerait que le nombre de forêts minimales d'une taille donnée est bien défini dans l'algèbre $\langle G \rangle / \text{Ker } N$. Par conséquent, le lemme 3.7 (qui est la grande difficulté du chapitre 6) serait inutile car seuls les coefficients des forêts minimales nous intéressent par la suite.

De plus, cela permettrait d'obtenir, pour n'importe quelle fonction polynomiale que l'on sait écrire en fonction des $N(G)$, une expression comme polynôme en R (dont tous les termes sont donc dans Λ^*) alors que le lemme 3.7 n'est pas généralisable à n'importe quelle fonction.

3.3.2.2 En utilisant la base S

Une autre manière d'aborder la question est la suivante : on voudrait déduire du théorème 2.7 une expression de Σ_μ en fonction des R . Le problème est que les $N(G)$ ne sont pas des fonctions polynômiales et ne peuvent donc pas être exprimés en fonction des R . La base (algébrique) des S que nous introduisons au paragraphe 3.2.1 permet de résoudre ce problème : en effet, on a une expression combinatoire de Σ_μ en fonction des S déduite du théorème 2.7 et on connaît explicitement l'expression des S en fonction des R (paragraphe 3.2.1).

Ceci permet de montrer que les coefficients des monômes en les R_j dans Σ_μ s'écrivent comme des sommes alternées de nombres de triplets $(\tau, \bar{\tau}, \varphi)$ où :

- $(\tau, \bar{\tau})$ est une factorisation d'une permutation σ donnée de type μ ;
- φ est une bijection $C(\tau) \simeq \{1, 2, \dots, |C(\tau)|\}$;
- les triplets doivent vérifier des conditions faisant intervenir le nombre V_A de cycles de $\bar{\tau}$ ayant au moins un point en commun avec un des cycles d'un sous-ensemble A donné de $C(\tau)$.

Les paragraphes 7.6 et 7.7 expliquent comment passer de cette expression à un nombre de triplets (sans multiplicité) et donnent ainsi une autre démonstration du théorème 3.8.

3.3.3 Lien entre les deux approches

L'interprétation combinatoire du paragraphe précédent permet de retrouver des formules compactes pour les coefficients des monômes de degré $|\mu| + \ell(\mu) - 2$ (le théorème 6.4, prouvé autrement par I.P. Goulden et A. Rattan d'une part [GR07] et P. Śniady d'autre part [Śni06a], ainsi que le théorème 6.8, qui constitue un résultat nouveau). La méthode pour établir ces théorèmes consiste à compter les cartes selon leur squelette, c'est-à-dire la carte obtenue après avoir émondé (retiré les sommets d'arité 1) et effacé les sommets d'arité 2. On remarque que calculer la contribution de toutes les cartes ayant un squelette donné fait apparaître naturellement la série génératrice des C_l introduits par Goulden et Rattan.

Mais il y a des simplifications qui apparaissent dans la formule de Goulden et Rattan et qu'on ne sait pas expliquer combinatoirement. Ainsi, il serait intéressant d'essayer de retrouver cette formule combinatoirement, de montrer la conjecture de C -positivité [GR07] ou d'établir la forme des coefficients conjecturée par M. Lassalle (voir paragraphe 3.3.1). En effet, ces formules suggèrent que la structure combinatoire des polynômes de Kerov n'est pas entièrement comprise.

Deuxième partie

Caractères du groupe symétrique :
formule exacte et comportement
asymptotique

4

A combinatorial formula for character values

Ce chapitre reprend le contenu de l'article [FŚ07], à paraître dans *Annals of Combinatorics*. This chapter corresponds to the article [FŚ07], to appear in *Annals of Combinatorics*.

Résumé

Dans son papier [Sta03], R. P. Stanley établit une élégante formule combinatoire pour les caractères des représentations irréductibles du groupe symétrique correspondant à des diagrammes de Young rectangulaires. Par la suite, dans [Sta06], il en conjecture une généralisation pour n'importe quel diagramme (théorème 2.7). Dans ce chapitre, nous prouvons cette conjecture en utilisant des fonctions de Schur décalées et les éléments de Jucys-Murphy.

Abstract

In his paper [Sta03], R. P. Stanley finds a nice combinatorial formula for characters of irreducible representations of the symmetric group of rectangular shape. Then, in [Sta06], he gives a conjectural generalisation for any shape. Here, we will prove this formula using shifted Schur functions and Jucys-Murphy elements.

4.1 The main theorem

In this article, we will think of $S(n)$ as the group of permutations of $\{1, \dots, n\}$ so there are canonical embeddings of S_k in S_n ($n \geq k$). The decomposition in cycles with disjoint supports of an element $\sigma \in S(n)$ will play a central role, so we will denote by $C(\sigma)$ the corresponding partition of $\{1, \dots, n\}$.

A partition of n is a weakly decreasing sequence of integers of sum n . The irreducible representations of $S(n)$ are canonically indexed by partitions λ of n (denoted $\lambda \vdash n$) and χ_λ is

the notation for the associated character. For $\mu \in S(k)$ and $\lambda \vdash n$, we will look here at the normalised character, defined by :

$$\Sigma_{\mu}(\lambda) = \frac{n(n-1)\dots(n-k+1)\chi_{\lambda}(\mu)}{\chi_{\lambda}(Id_n)},$$

where we have to identify μ with its image by the natural embedding of $S(k)$ in $S(n)$ to compute $\chi_{\lambda}(\mu)$.

Let m be a positive integer.

- If $\mathbf{p} = (p_1, \dots, p_m)$ and $\mathbf{q} = (q_1, \dots, q_m)$ with $q_1 \geq \dots \geq q_m$ are two sequences of positive integers, we will denote by $\mathbf{p} \times \mathbf{q}$ the partition :

$$(\mathbf{p} \times \mathbf{q})_i = \begin{cases} q_1 & \text{if } 1 \leq i \leq p_1; \\ q_2 & \text{if } p_1 + 1 \leq i \leq p_1 + p_2; \\ \vdots & \\ q_m & \text{if } p_1 + \dots + p_{m-1} + 1 \leq i \leq p_1 + \dots + p_m; \\ 0 & \text{if } i > p_1 + \dots + p_m. \end{cases}$$

- Take an element of $S(k)$ and assign to each of its cycle an integer between 1 and m . The set of such coloured permutations (formally of pairs (σ, φ) , $\sigma \in S(k)$ and $\varphi : C(\sigma) \rightarrow \{1, \dots, m\}$) is denoted by $S(k)^{(m)}$. Note that φ can also be seen as a function $\{1, \dots, k\} \rightarrow \{1, \dots, m\}$ invariant by action of σ . Given a coloured permutation $(\sigma, \varphi) \in S(k)^{(m)}$ and a non-coloured one $\mu \in S(k)$, we can define their product (but it doesn't define a right group action) by $(\sigma, \varphi) \cdot \mu = (\sigma\mu, \psi)$ where,

$$\text{if } c \in C(\sigma\mu), \psi(c) = \max_{a \in c} \varphi(a). \quad (40)$$

We can now give the formulation of the main theorem of this article, which was conjectured by Stanley in [Sta06] :

Theorem 4.1. *Let k, m be positive integers, $\mu \in S(k)$. For any sequences \mathbf{p}, \mathbf{q} of m positive integers (\mathbf{q} being non-increasing), we have*

$$\Sigma_{\mu}(\mathbf{p} \times \mathbf{q}) = (-1)^k \sum_{(\sigma, \varphi) \in S(k)^{(m)}} \left(\prod_{b \in C(\sigma)} p_{\varphi(b)} \prod_{c \in C(\sigma\mu)} -q_{\psi(c)} \right), \quad (41)$$

where ψ is defined by (40).

The case $m = 1$ and the equality of highest degree terms (as polynomials in \mathbf{p} and \mathbf{q}) have already been shown, respectively by R. Stanley in [Sta03] and A. Rattan in [Rat07b]. In section 4.2, we introduce some useful objects and results, which we will use in section 4.3 to prove this theorem.

4.2 Useful objects

4.2.1 Stabilizers

The composition $\mathbf{i} \circ \tau$ defines a right action of the symmetric group on the sequences of integers between 1 and m of length k . If \mathbf{i} is such a sequence, we will denote by $\text{Stab}(\mathbf{i})$ the stabilizer of \mathbf{i} (that is to say the set $\{\tau, \mathbf{i} \circ \tau = \mathbf{i}\}$) and by $\delta_{\mathbf{i}}$ its characteristic function :

$$\delta_{\mathbf{i}}(\sigma) = \sum_{s \in \text{Stab}(\mathbf{i})} \delta_{\sigma s^{-1}},$$

where $\delta_{\sigma} = 1$ if $\sigma = Id$ and 0 else. We will use the following easy properties :

- $\text{Stab}(\mathbf{i} \circ \tau) = \tau^{-1} \text{Stab}(\mathbf{i}) \tau$.
- $|\{\tau, \mathbf{i} \circ \tau = \mathbf{j}\}|$ is either 0 or $|\text{Stab}(\mathbf{i})|$.
- Any sequence \mathbf{j} is in the orbit of exactly one non-increasing sequence.

4.2.2 Young basis

As usual, we draw a partition $\lambda \vdash k$ as a Young diagram (λ_1 squares in the first line, λ_2 in the second, and so on, all the lines are left justified). A Young standard tableau of shape λ (their set will be denoted $YST(\lambda)$) is this Young diagram, filled with the numbers from 1 to k , such that all lines and all columns are increasing. It is well-known that the dimension of the representation associated to λ is the cardinal of $YST(\lambda)$. We recall here the construction of a basis indexed by these objects :

Let λ be a partition of k and W_{λ} be the irreducible associated $S(k)$ -module (defined up to isomorphism). There exists on W_{λ} an unique $S(k)$ -invariant scalar product (the uniqueness is only true up to multiplication by a positive real number, but we will fix it for the end of the article). We will define by induction the Young orthonormal basis of W_{λ} . For $W_{(0)}$, we have only one choice up to multiplication by a scalar. Then, we use the branching rule (see [Sag01], theorem 2.8.3 for example) : as $S(k-1)$ -module, we have

$$W_{\lambda} \simeq \bigoplus_{\substack{\lambda' \vdash k-1 \\ \lambda' \leq \lambda}}^{\perp} W'_{\lambda'},$$

where the inequality $\lambda' \leq \lambda$ is meant component by component (we will denote the two conditions by $\lambda' \nearrow \lambda$). The union of the Young orthonormal basis for each $W'_{\lambda'}$ is an orthogonal basis of W_{λ} . Multiplying each vector by a scalar, we obtain an orthonormal basis (we have a choice of unitary scalar to do but it doesn't matter). It is clear that the elements of the Young basis for W_{λ} are indexed by sequences

$$\lambda_0 = (0) \nearrow \lambda_1 \nearrow \dots \nearrow \lambda_{k-1} \nearrow \lambda_k = \lambda,$$

or, equivalently, by Young standard tableaux of shape λ . We can denote this basis $(v_T)_{T \in YST(\lambda)}$.

As it is an orthonormal basis, we can use it to compute the character :

$$\forall s \in \mathbb{C}[S(k)], \chi_\lambda(s) = \text{tr}_{W_\lambda}(s) = \sum_{T \in YST(\lambda)} \langle s \cdot v_T, v_T \rangle. \quad (42)$$

4.2.3 Jucys-Murphy elements

The following elements of the symmetric group algebra, introduced by A. Jucys and G. Murphy (see [Juc74] and [Mur81]), play a very important role in the proof of the theorem :

$$\forall i \leq k, \text{ let } \xi_i = (1i) + (2i) + \dots + (i-1i).$$

These elements are very interesting because :

1. The products of different Jucys-Murphy elements have a nice combinatoric expression in the symmetric group algebra.
2. They are diagonal operators in the Young basis.

4.2.3.1 Combinatorics of products of Jucys-Murphy elements

We will need in section 4.3 the following result :

Lemma 4.2. *For every integer k and every set of variables $(X_j)_{1 \leq j \leq k}$, we have :*

$$X_1(X_2 - \xi_2) \dots (X_k - \xi_k) = (-1)^k \sum_{\sigma \in S(k)} \left(\prod_{c \in C(\sigma)} -X_{\min(c)} \right) \sigma. \quad (43)$$

Proof : we will prove it by induction over k , using the natural embedding of $S(k-1)$ in $S(k)$. The case $k=1$ is obvious.

Let $k > 1$ and $\sigma \in S(k)$. We will look at the coefficient of σ in the left side of the equality (43). Using the induction hypothesis, one can write :

$$\begin{aligned} & X_1(X_2 - \xi_2) \dots (X_k - \xi_k) \\ &= \left((-1)^{k-1} \sum_{\sigma' \in S(k-1)} \left(\prod_{c \in C(\sigma')} -X_{\min(c)} \right) \sigma' \right) (X_k - \xi_k); \\ &= (-1)^k \sum_{\sigma' \in S(k-1)} \left(\prod_{c \in C(\sigma')} -X_{\min(c)} \right) (-X_k) \sigma' \\ & \quad + (-1)^k \sum_{\sigma' \in S(k-1)} \sum_{j=1}^{k-1} \left(\prod_{c \in C(\sigma')} -X_{\min(c)} \right) \sigma'(jk). \end{aligned} \quad (44)$$

We distinguish two cases :

- σ fixes k . It is the image of a permutation $\sigma' \in S(k-1)$ by the natural embedding. So, the coefficient of σ in (44) is

$$(-1)^k \left(\prod_{c \in C(\sigma')} -X_{\min(c)} \right) \cdot (-X_k).$$

Looking at the cycles of the two permutations, we see that :

$$C(\sigma) = C(\sigma') \cup \{k\}.$$

So we have our result in this case.

- Else, let $j = \sigma^{-1}(k)$, so that σ can be written as $\sigma'(jk)$ and this is the only contribution to the coefficient of σ in (44). Thus σ appears with the scalar :

$$(-1)^k \left(\prod_{c \in C(\sigma')} -X_{\min(c)} \right).$$

But the cycles of σ' are the same as the cycles of σ , excepted that we have removed k in the cycle which contained it (this cycle couldn't be the singleton $\{k\}$). So the lemma is proved.

4.2.3.2 Action on Young basis

Définition 4.1. The content of the j -th box of the i -th line of a Young diagram is by definition the difference $j - i$. If T is a standard tableau with k boxes and $1 \leq a \leq k$, we will denote by $c_T(a)$ the content of the box containing the entry a .

We can now state the following result, also due to A. Jucys and G. Murphy.

Lemma 4.3.

$$\forall i \in \{1, \dots, k\} \text{ and } T \in YST(\lambda), \xi_i(v_T) = c_T(i)v_T. \quad (45)$$

A proof can be found in [Oko96b].

Remark : an example of application of these two properties of Jucys-Murphy elements is the well-known formula :

$$\dim(\lambda) \prod_{\square \in \lambda} (X + c(\square)) = \sum_{s \in S(k)} \chi_\lambda(\sigma) X^{|\mathcal{C}(\sigma)|}.$$

4.2.4 Shifted Schur functions

The other important objects in this paper are shifted Schur functions. The definition 4.4 and the theorem 4.5 can be found in A. Okounkov's and G. Olshanski's article [OO98a] :

Definition-Proposition 4.4. Let λ be a partition of k . We define the λ shifted Schur polynomials as

$$s_{\lambda}^*(x_1, x_2, \dots, x_l) = \frac{\det((x_i + l - i)_{\lambda_j + l - j})_{1 \leq i, j \leq l}}{\det((x_i + l - i)_{l - j})_{1 \leq i, j \leq l}},$$

where $(r)_t = r(r-1)\dots(r-t+1)$. We can state that :

$$s_{\lambda}^*(x_1, x_2, \dots, x_l, 0) = s_{\lambda}^*(x_1, x_2, \dots, x_l),$$

so s_{λ}^* is an element of the algebra of polynomials in countably many variables (symmetric in $x_1 - 1, x_2 - 2, \dots$).

4.2.4.1 Link with characters

As suggested by A. Rattan in his paper [Rat07a], where he gives a new easier proof of the case $m = 1$, we will use the following theorem :

Theorem 4.5 (A. Okounkov, G. Olshanski). For any integers $k \leq n$, permutation $\mu \in S(k)$ and partition $\nu \vdash n$, we have :

$$\Sigma_{\mu}(\nu) = \sum_{\lambda \vdash k} \chi_{\lambda}(\mu) s_{\lambda}^*(\nu).$$

4.2.4.2 A new formula

The new idea in this paper is to write $s_{\lambda}^*(\nu)$ as the character of an element of the symmetric group algebra. We will be able to do this, thanks to this expression of shifted Schur polynomials, which was pointed to me by P. Biane and can be found in A. Okounkov's paper [Oko96a] (see (3.28) together with (3.34)) : for $\lambda \vdash k$,

$$s_{\lambda}^*(\nu) = \sum_{T \in YST(\lambda)} \sum_{i_1 \geq i_2 \geq \dots \geq i_k \geq 1} \frac{1}{|\text{Stab}(\mathbf{i})|} \cdot \left[\sum_{s \in \text{Stab}(\mathbf{i})} \langle s \cdot v_T, v_T \rangle \nu_{i_1} (\nu_{i_2} - c_T(2)) \dots (\nu_{i_k} - c_T(k)) \right]. \quad (46)$$

Let, for $k \geq 1$ and $\nu \vdash n$ with $n \geq k$, \mathcal{S}_{ν}^k be the following element of $\mathbb{C}[S(n)]$:

$$\mathcal{S}_{\nu}^k = \sum_{i_1 \geq i_2 \geq \dots \geq i_k \geq 1} \sum_{s \in \text{Stab}(\mathbf{i})} \frac{s}{|\text{Stab}(\mathbf{i})|} \nu_{i_1} (\nu_{i_2} - \xi_2) \dots (\nu_{i_k} - \xi_k), \quad (47)$$

Now, we can establish a new formula for shifted Schur polynomials.

Theorem 4.6. If $\lambda \vdash k$ and $\nu \vdash n$,

$$s_{\lambda}^*(\nu) = \chi_{\lambda}(\mathcal{S}_{\nu}^k). \quad (48)$$

Proof : Let's write the formula (42) for \mathcal{S}_ν^k .

$$\chi_\lambda(\mathcal{S}_\nu^k) = \sum_{T \in YST(\lambda)} \langle \mathcal{S}_\nu^k \cdot T, T \rangle.$$

The lemma 4.3 implies that, for any standard tableau T , any sequence $i_1 \geq i_2 \geq \dots \geq i_k \geq 1$ and any $s \in \text{Stab}(\mathbf{i})$, we have

$$\begin{aligned} [\nu_{i_1} (\nu_{i_2} - \xi_2) \dots (\nu_{i_k} - \xi_k)] \cdot v_T &= [\nu_{i_1} (\nu_{i_2} - c_T(2)) \dots (\nu_{i_k} - c_T(k))] v_T; \\ [s \cdot \nu_{i_1} (\nu_{i_2} - \xi_2) \dots (\nu_{i_k} - \xi_k)] \cdot v_T &= [\nu_{i_1} (\nu_{i_2} - c_T(2)) \dots (\nu_{i_k} - c_T(k))] s \cdot v_T. \end{aligned}$$

Now, taking the scalar product with T and summing over T , \mathbf{i} and s , we find that $\chi_\lambda(\mathcal{S}_\nu^k)$ is exactly the right member of the equality (46), so the theorem is proved.

The element (47) might be very interesting to study to obtain results on shifted Schur functions. Here, we will look at the sum of the coefficients of permutations in the same conjugacy class as μ .

4.2.5 Orthogonality relations of the second kind

In this paragraph, we will get from the orthogonality formula for irreducible characters an other relation. This can also be found in [Sag01], thm 1.10.3. The classical formula can be written the following way : for any partitions λ and λ' of k , we have

$$\sum_{\mathcal{C}} \frac{|\mathcal{C}|}{|G|} \chi_\lambda(\mathcal{C}) \chi_{\lambda'}(\mathcal{C}) = \delta_{\lambda, \lambda'},$$

where the sum is taken over all conjugacy classes of $S(k)$. So we can reformulate it, saying that the square matrix

$$\left(\chi_\lambda(\mathcal{C}) \sqrt{\frac{|\mathcal{C}|}{|G|}} \right)_{\substack{\mathcal{C} \text{ c.c. of } S(k) \\ \lambda \vdash k}}$$

is unitary. Looking at its rows, we have the following formula for any conjugacy classes \mathcal{C} and \mathcal{C}' :

$$\sum_{\lambda \vdash k} \frac{\sqrt{|\mathcal{C}| \cdot |\mathcal{C}'|}}{|G|} \chi_\lambda(\mathcal{C}) \chi_\lambda(\mathcal{C}') = \delta_{\mathcal{C}, \mathcal{C}'}$$

If μ and σ are in the same conjugacy class \mathcal{C} , there are exactly $\frac{|G|}{|\mathcal{C}|}$ permutations $\tau \in S(k)$ such that $\tau\mu\tau^{-1} = \sigma$ (and of course there aren't any if they are in different conjugacy classes), so we can rewrite the previous equation under the form :

$$\sum_{\lambda \vdash k} \chi_\lambda(\mu) \chi_\lambda(\sigma) = \sum_{\tau \in S(k)} \delta_{\tau\mu\tau^{-1}\sigma^{-1}}. \quad (49)$$

This formula can of course be extended by linearity in σ to the group algebra $\mathbb{C}[S(k)]$.

$$\sum_{\lambda \vdash k} \chi_\lambda(\mu) \chi_\lambda \left(\sum_{\sigma \in S(k)} c_\sigma \sigma \right) = \sum_{\tau \in S(k)} \sum_{\sigma \in S(k)} c_\sigma \delta_{\tau\mu\tau^{-1}\sigma^{-1}}. \quad (50)$$

4.3 Proof of Stanley's conjecture

As it is noticed in Stanley's paper [Sta06], one can reduce the conjecture to the case $p_1 = \dots = p_m = 1$. Indeed, one can check easily that both sides of the equation (41) verify the following functional equation in \mathbf{p} and \mathbf{q} :

$$F(\mathbf{p}, \mathbf{q})|_{q_i=q_{i+1}} = F(p_1, \dots, p_i + p_{i+1}, \dots, p_m, q_1, \dots, q_i, q_{i+2}, \dots, q_m).$$

In this case, the partition $\nu = 1^m \times \mathbf{q}$ is simply given by $\nu_i = q_i$ if $1 \leq i \leq m$ and $\nu_i = 0$ else.

As mentionned earlier, we will use theorems 4.5 and 4.6 to get the following expression of the normalised character :

$$\Sigma_\mu(1^m \times \mathbf{q}) = \sum_{\lambda \vdash k} \chi_\lambda(\mu) \chi_\lambda(\mathcal{S}_{1^m \times \mathbf{q}}^k). \quad (51)$$

The lemma 4.2, applied to $X_j = q_{i_j}$ gives a nicer expression of $\mathcal{S}_{1^m \times \mathbf{q}}^k$:

$$\Sigma_\mu(1^m \times \mathbf{q}) = (-1)^k \sum_{\lambda \vdash k} \chi_\lambda(\mu) \chi_\lambda \left(\sum_{m \geq i_1 \geq i_2 \geq \dots \geq i_k \geq 1} \frac{\sum_{s \in \text{Stab}(\mathbf{i})} s}{|\text{Stab}(\mathbf{i})|} \sum_{\sigma \in S(k)} \left(\prod_{c \in C(\sigma)} -q_{i_{\min(c)}} \right) \sigma \right). \quad (52)$$

We now use the orthogonality relation (50) and obtain :

$$\Sigma_\mu(1^m \times \mathbf{q}) = (-1)^k \sum_{\tau \in S(k)} \sum_{m \geq i_1 \geq i_2 \geq \dots \geq i_k \geq 1} \frac{1}{|\text{Stab}(\mathbf{i})|} \left[\sum_{\sigma \in S(k)} \left(\prod_{c \in C(\sigma)} -q_{\max_c \mathbf{i}} \right) \sum_{s \in \text{Stab}(\mathbf{i})} \delta_{\tau \mu \tau^{-1} \sigma^{-1} s^{-1}} \right] \quad (53)$$

As $\sigma \mapsto \tau \sigma \tau^{-1}$ defines a bijection of the symmetric group into itself, we can replace σ by $\tau \sigma \tau^{-1}$ in the second line of the previous equation.

$$\Sigma_\mu(1^m \times \mathbf{q}) = (-1)^k \sum_{\tau \in S(k)} \sum_{m \geq i_1 \geq i_2 \geq \dots \geq i_k \geq 1} \frac{1}{|\text{Stab}(\mathbf{i})|} \left[\sum_{\sigma \in S(k)} \left(\prod_{c \in C(\tau \sigma \tau^{-1})} -q_{\max_c \mathbf{i}} \right) \delta_{\mathbf{i}}(\tau \mu \sigma^{-1} \tau^{-1}) \right] \quad (54)$$

$$\Sigma_\mu(1^m \times \mathbf{q}) = (-1)^k \sum_{\tau \in S(k)} \sum_{m \geq i_1 \geq i_2 \geq \dots \geq i_k \geq 1} \left[\frac{1}{|\text{Stab}(\mathbf{i} \circ \tau)|} \sum_{\sigma \in S(k)} \left(\prod_{c \in C(\sigma)} -q_{\max_c \mathbf{i} \circ \tau} \right) \delta_{\mathbf{i} \circ \tau}(\mu \sigma^{-1}) \right] \quad (55)$$

Now, we can see that the expression in the brackets depends only on the sequence $\mathbf{i} \circ \tau$. Each sequence (j_1, \dots, j_k) of integers between 1 and m (but not necessarily non-increasing) can be written as $|\text{Stab}(\mathbf{j})|$ different ways as $\mathbf{i} \circ \tau$, where \mathbf{i} is non-increasing and $\tau \in S(k)$ (in all these writings \mathbf{i} is the same but τ can be chosen among $|\text{Stab}(\mathbf{j})| = |\text{Stab}(\mathbf{i})|$ permutations). So we have :

$$\Sigma_{\mu}(1^m \times \mathbf{q}) = (-1)^k \sum_{\substack{1 \leq j_1 \leq m \\ \vdots \\ 1 \leq j_k \leq m}} \sum_{\sigma \in S(k)} \left(\prod_{c \in C(\sigma)} -q_{\max_c \mathbf{j}} \right) \delta_{\mathbf{j}}(\mu \sigma^{-1}); \quad (56)$$

$$\Sigma_{\mu}(1^m \times \mathbf{q}) = (-1)^k \sum_{\sigma \in S(k)} \sum_{\mathbf{j} \text{ fixed by } \mu \sigma^{-1}} \left(\prod_{c \in C(\sigma)} -q_{\max_c \mathbf{j}} \right). \quad (57)$$

Note that the sequences of integers between 1 and m fixed by a permutation are exactly the colourings of its cycles in m colours (the colour of a cycle is the common value of \mathbf{j} on its elements). So, if we change the index of the sum over $S(k)$ putting $\sigma' = \sigma \mu^{-1}$, we can write :

$$\Sigma_{\mu}(1^m \times \mathbf{q}) = (-1)^k \sum_{\sigma' \in S(k)} \sum_{\substack{\mathbf{j} \text{ such that} \\ (\sigma', \mathbf{j}) \in S(k)^{(m)}}} \left(\prod_{c \in C(\sigma' \mu)} -q_{\max_c \mathbf{j}} \right), \quad (58)$$

which is exactly (41) in the case $p_1 = \dots = p_m = 1$.

5

Asymptotics of characters of symmetric groups related to Stanley-Feray character formula

Ce chapitre reprend le contenu de l'article [FŚ07], écrit en collaboration avec Piotr Śniady, soumis à *Annals of Mathematics*.

This chapter corresponds to the article [FŚ07], written with Piotr Śniady and submitted to *Annals of Mathematics*.

Résumé

Dans ce chapitre nous établissons une borne supérieure pour les caractères irréductibles du groupe symétrique. Plus précisément, nous montrons qu'il existe une constante $a > 0$ avec la propriété que, pour tout diagramme de Young λ avec n cases, $r(\lambda)$ lignes et $c(\lambda)$ colonnes,

$$|\chi^\lambda(\pi)| \leq \left[a \max \left(\frac{r(\lambda)}{n}, \frac{c(\lambda)}{n}, \frac{|\pi|}{n} \right) \right]^{|\pi|},$$

où $|\pi|$ est le nombre minimal de facteurs nécessaires pour écrire $\pi \in S_n$ comme un produit de transpositions et

$$\chi^\lambda(\pi) = \frac{\text{Tr } \rho^\lambda(\pi)}{\text{Tr } \rho^\lambda(e)}$$

est le caractère normalisé du groupe symétrique. Nous établissons aussi des bornes uniformes pour le termes d'erreur dans les équivalents pour les valeurs des caractères de Vershik et Kerov d'une part et de Biane d'autre part. Nous donnons par ailleurs une nouvelle formule pour les cumulants libres de la mesure de transition.

Abstract

We prove an upper bound for characters of the symmetric groups. Namely, we show that there exists a constant $a > 0$ with a property that for every Young diagram λ with n boxes, $r(\lambda)$ rows and $c(\lambda)$ columns,

$$|\chi^\lambda(\pi)| \leq \left[a \max \left(\frac{r(\lambda)}{n}, \frac{c(\lambda)}{n}, \frac{|\pi|}{n} \right) \right]^{|\pi|},$$

where $|\pi|$ is the minimal number of factors needed to write $\pi \in S_n$ as a product of transpositions and

$$\chi^\lambda(\pi) = \frac{\text{Tr } \rho^\lambda(\pi)}{\text{Tr } \rho^\lambda(e)}$$

is the character of the symmetric group. We also give uniform estimates for the error term in the Vershik-Kerov's and Biane's character formulas and give a new formula for free cumulants of the transition measure.

5.1 Introduction

5.1.1 Normalized characters

For a Young diagram λ having n boxes and a permutation $\pi \in S_l$ (where $l \leq n$) we define the *normalized character*

$$\Sigma^\lambda(\pi) = (n)_l \chi^\lambda(\pi), \tag{59}$$

where $(n)_l = n(n-1)\cdots(n-l+1)$ denotes the falling power and where

$$\chi^\lambda(\pi) = \frac{\text{Tr } \rho^\lambda(\pi)}{\text{Tr } \rho^\lambda(e)}$$

is the character rescaled in such a way that $\chi^\lambda(e) = 1$.

5.1.2 Short history of the problem

Unfortunately, the canonical tool for calculating characters, the Murnaghan–Nakayama rule, quickly becomes cumbersome and hence intractable for computing characters corresponding to large Young diagrams. Nevertheless Roichman [Roi96] showed that it is possible to use it to find an upper bound for characters, namely he proved that there exist constants $0 < q < 1$ and $b > 0$ such that

$$|\chi^\lambda(\pi)| \leq \left[\max \left(\frac{r(\lambda)}{n}, \frac{c(\lambda)}{n}, q \right) \right]^{b |\text{supp } \pi|}, \tag{60}$$

where $r(\lambda)$, $c(\lambda)$ denote the number of rows and columns of λ and $\text{supp } \pi$ denotes the support of a permutation π (the set of its non-fixed points). Inequality (60) is not satisfactory for many practical purposes (such as [MR06]) since it provides rather weak estimates in the

case when the Young diagram λ is *balanced*, i.e. $r(\lambda), c(\lambda) = O(\sqrt{n})$ and π is not a very long permutation, i.e. $|\text{supp}(\pi)| = o(n)$.

Another approach to this problem was initiated by Biane [Bia98, Bia03] who showed that the value of the normalized character $\Sigma^\lambda(\pi)$ can be expressed as a relatively simple polynomial—called Kerov character polynomial—in *free cumulants* of the *transition measure* of a Young diagram λ . The work of Biane was based on previous contributions of Kerov [Ker93, Ker99] and Vershik. Since free cumulants of the transition measure have a nice geometric interpretation therefore Kerov polynomials are a perfect tool for study of the character $\chi^\lambda(\pi)$ in the limit when the permutation π is fixed and the Young diagram λ tends in some sense to infinity.

Unfortunately, despite much progress in this field [Šni06d, GR07] our understanding of Kerov polynomials is still not satisfactory; in particular it is not clear how to use Kerov polynomials in order to obtain non-trivial estimates on the characters $\chi^\lambda(\pi)$ when the length $|\pi|$ of the permutation $\pi \in S_n$ is comparable with n .

In a recent work of one of us with Rattan [RŠ08] we took yet another approach: thanks to the generalized Frobenius formula we showed that the value of a normalized character of a given Young diagram λ can be bounded from above by the value of the normalized character of a rectangular Young diagram $p \times q$ for suitably chosen p, q . For such a rectangular Young diagram the value of the normalized character can be explicitly calculated thanks to the formula of Stanley [Sta03] (which will be recalled as Theorem 5.3 in Section 5.2). In this way we proved that for each C there exists a constant D with a property that if $r(\lambda), c(\lambda) < C\sqrt{n}$ then

$$|\chi^\lambda(\pi)| < \left(\frac{D \max(1, \frac{|\pi|^2}{n})}{\sqrt{n}} \right)^{|\pi|}, \quad (61)$$

where $|\pi|$ denotes the minimal number of factors necessary to write π as a product of transpositions. Inequality (61) gives a much better estimate than (60) for balanced Young diagrams and quite short permutation ($|\pi| = o(\sqrt{n})$) but it gives non-trivial estimates only if $\max(r(\lambda), c(\lambda)) < O(n^{3/4})$.

For the sake of completeness we point out that the studies of Kerov polynomials and of the Stanley character formula are very much related to each other [Bia03].

5.1.3 The main result

Our main result is the following inequality.

Theorem 5.1. *There exists a constant $a > 0$ with a property that for every Young diagram λ*

$$|\chi^\lambda(\pi)| \leq \left[a \max \left(\frac{r(\lambda)}{n}, \frac{c(\lambda)}{n}, \frac{|\pi|}{n} \right) \right]^{|\pi|},$$

where n denotes the number of boxes of λ .

It is easy to check that (61) is a consequence of this theorem and that it gives better estimates than (60) if $\frac{r(\lambda)}{n}, \frac{c(\lambda)}{n}, \frac{|\pi|}{n}$ are smaller than some positive constant. It is natural to ask what is the optimal value of the constant a . Asymptotics of characters of symmetric groups related to Thoma characters shows that $a \geq 1$.

5.1.4 Young diagrams

In the following we shall identify a Young diagram λ with the set of its boxes which we regard as a subset of \mathbb{N}^2 given by a graphical representation of λ according to the French notation; namely, for a partition $\lambda = (\lambda_1, \dots, \lambda_k)$ it is the set

$$\lambda = \bigcup_{1 \leq i \leq k} \{1, 2, \dots, \lambda_i\} \times \{i\} = \{(p, q) \in \mathbb{N}^2 : 1 \leq p \leq \lambda_q\}. \quad (62)$$

5.1.5 The main tool : reformulation of Stanley-Féray character formula

Our main tool in our investigations will be the following reformulation of Stanley-Féray character formula.

The set of cycles of a permutation π is denoted by $C(\pi)$. For given permutations $\sigma_1, \sigma_2 \in S_l$ we shall consider colorings h of the cycles of σ_1 (where each cycle is colored by the number of some column of λ) and of the cycles of σ_2 (where each cycle is colored by the number of some row of λ). Formally, each such coloring can be viewed as a function $h : C(\sigma_1) \sqcup C(\sigma_2) \rightarrow \mathbb{N}$. We say that a coloring h is compatible with a Young diagram λ if for all $c_1 \in C(\sigma_1)$ and $c_2 \in C(\sigma_2)$ if $c_1 \cap c_2 \neq \emptyset$ then $(h(c_1), h(c_2)) \in \lambda$; in other words

$$0 < h(c_1) \leq \lambda_{h(c_2)} \quad (63)$$

holds true for all $c_1 \in C(\sigma_1)$, $c_2 \in C(\sigma_2)$ such that $c_1 \cap c_2 \neq \emptyset$.

Theorem 5.2 (The new formulation of Stanley-Féray character formula). *For any Young diagram λ and a permutation $\pi \in S_l$ (where $l \leq n$) the value of the normalized character (59) is given by*

$$\Sigma^\lambda(\pi) = \sum_{\substack{\sigma_1, \sigma_2 \in S_l, \\ \sigma_1 \sigma_2 = \pi}} (-1)^{|\sigma_1|} N^\lambda(\sigma_1, \sigma_2), \quad (64)$$

where

$$N^\lambda(\sigma_1, \sigma_2) = \#\{h : h \text{ is a coloring of the cycles of } \sigma_1 \text{ and } \sigma_2 \text{ which is compatible with } \lambda\}. \quad (65)$$

Example. For a given factorization $\pi = \sigma_1 \sigma_2$ it is convenient to consider a bipartite graph with the set of vertices $C(\sigma_1) \sqcup C(\sigma_2)$ and with an edge between vertices $c_1 \in C(\sigma_1)$ and $c_2 \in C(\sigma_2)$ if and only if $c_1 \cap c_2 \neq \emptyset$. Notice that the value of $N^\lambda(\sigma_1, \sigma_2)$ does not depend on the exact form of σ_1 and σ_2 but only on the corresponding bipartite graph.

Figure 5.1 presents such a bipartite graph for $\pi = (12)$, $\sigma_1 = (1)(2)$, $\sigma_2 = (12)$. Now it becomes clear that

$$N^\lambda((1)(2), (12)) = \sum_i (\lambda_i)^2;$$

similarly

$$N^\lambda((12), (1)(2)) = \sum_i (\lambda'_i)^2,$$

where λ' denotes the Young diagram conjugate to λ . In this way Theorem 5.2 shows that

$$\Sigma^\lambda(12) = n(n-1) \frac{\text{Tr } \rho^\lambda(12)}{\text{Tr } \rho^\lambda(e)} = N^\lambda((1)(2), (12)) - N^\lambda((12), (1)(2)) = \sum_i (\lambda_i)^2 - \sum_i (\lambda'_i)^2.$$

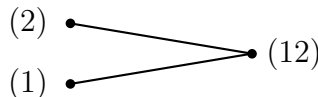

FIG. 5.1 – Bipartite graph associated to the factorization $(12) = (1)(2) \cdot (12)$.

5.1.6 Overview of the paper

In Section 5.2 we recall the original version of Stanley-Féray character formula. We also show that it is equivalent to Theorem 5.2 and we present its new proof.

In Section 5.3 we present a relation between the characters of symmetric groups and characters of some Gaussian random matrices. We also give a new formula for calculating free cumulants of (the transition measure of) a Young diagram.

Section 5.4 is devoted to the proofs of some technical inequalities.

In Section 5.5 we prove estimates for the characters of the symmetric groups based on Stanley-Féray character formula.

5.2 Stanley-Féray character formula

5.2.1 The original version of Stanley-Féray character formula

The direction of research presented in this paper was initiated by Stanley [Sta03] who proved the following result.

Theorem 5.3. *For any integers $p, q \geq 1$ the normalized character of the rectangular Young diagram $p \times q = \underbrace{(q, \dots, q)}_{p \text{ times}}$ is given on $\pi \in S_l$ by*

$$\Sigma^{p \times q}(\pi) = \sum_{\substack{\sigma_1, \sigma_2 \in S_l, \\ \sigma_1 \sigma_2 = \pi}} (-1)^{|\sigma_1|} q^{|\mathcal{C}(\sigma_1)|} p^{|\mathcal{C}(\sigma_2)|}.$$

Let $\mathbf{p} = (p_1, \dots, p_r)$ and $\mathbf{q} = (q_1, \dots, q_r)$ with $q_1 \geq \dots \geq q_r$ be two sequences of positive integers. We denote by $\mathbf{p} \times \mathbf{q}$ the multi-rectangular partition

$$\mathbf{p} \times \mathbf{q} = \left(\underbrace{q_1, \dots, q_1}_{p_1 \text{ times}}, \underbrace{q_2, \dots, q_2}_{p_2 \text{ times}}, \dots \right). \tag{66}$$

We denote by $S(l)^{(r)}$ the set of *colored permutations*, i.e. pairs (σ, ϕ) , where $\sigma \in S_l$ and $\phi : \{1, \dots, l\} \rightarrow \{1, \dots, r\}$ is a function constant on each cycle of σ . Alternatively, the coloring ϕ can be regarded as a function on $C(\sigma)$, the set cycles of σ . Given a colored permutation $(\sigma, \phi) \in S(l)^{(r)}$ and a non-colored one $\pi \in S_l$ we define their product $(\sigma, \phi) \cdot \pi = (\sigma\pi, \psi)$, where the coloring ψ is defined by

$$\psi(c) = \max_{a \in c} \phi(a), \quad (67)$$

where $c \in C(\sigma\pi)$.

The following generalization of Theorem 5.3 to multi-rectangular Young diagrams was conjectured by Stanley [Sta06] and proved by Féray [Fér08b] and therefore we refer to it as Stanley-Féray character formula.

Theorem 5.4 (The original formulation of Stanley-Féray character formula). *The value of the normalized character is given on $\pi \in S_l$ by*

$$\Sigma^{\mathbf{p} \times \mathbf{q}}(\pi) = (-1)^l \sum_{(\sigma, \phi) \in S(l)^{(r)} } \left[\prod_{b \in C(\sigma)} p_{\phi(b)} \prod_{c \in C(\sigma\pi)} -q_{\psi(c)} \right], \quad (68)$$

where ψ was defined in (67).

5.2.2 Equivalence of the two formulations of Stanley-Féray character formula

In this section we will show that Theorem 5.2 implies Theorem 5.4 (the proof of the opposite implication is analogous and we leave it to the Reader).

Proof : [Theorem 5.2 implies Theorem 5.4] Let permutations $\sigma_1, \sigma_2 \in S_l$ such that $\sigma_1\sigma_2 = \pi^{-1}$ be given. We denote $\sigma = \sigma_2$.

The sequence $(\underbrace{1, \dots, 1}_{p_1 \text{ times}}, \underbrace{2, \dots, 2}_{p_2 \text{ times}}, \dots)$ can be viewed as a coloring of the set $\{1, \dots, p_1 + \dots + p_r\}$ with the colors $\{1, \dots, r\}$. In this way a function $h : C(\sigma_2) \rightarrow \{1, 2, \dots, p_1 + \dots + p_r\}$ defines a coloring ϕ of the permutation σ_2 . Clearly, there are $\prod_{b \in C(\sigma)} p_{\phi(b)}$ functions h which correspond to a given coloring ϕ .

We shall count now in how many ways a function $h : C(\sigma_2) \rightarrow \{1, 2, \dots, p_1 + \dots + p_r\}$ can be extended to a function $h : C(\sigma_1) \sqcup C(\sigma_2) \rightarrow \mathbb{N}$ compatible with σ_1, σ_2 . Condition (63) takes the form

$$\text{for all } c_1 \in C(\sigma_1), c_2 \in C(\sigma_2) \text{ if } c_1 \cap c_2 \neq \emptyset \text{ then } 0 < h(c_1) \leq q_{\phi(c_2)};$$

in other words for every $c_1 \in C(\sigma_1)$

$$0 < h(c_1) \leq \min_{\substack{c_2 \in C(\sigma_2), \\ c_1 \cap c_2 \neq \emptyset}} q_{\phi(c_2)} = \min_{a \in c_1} q_{\phi(a)} = q_{\psi(c_1)}$$

therefore the number of such extensions is equal to $\prod_{c \in C(\sigma\pi)} q_{\psi(c)}$.

In this way we proved that

$$\Sigma^{\mathbf{p} \times \mathbf{q}}(\pi) = \Sigma^{\mathbf{p} \times \mathbf{q}}(\pi^{-1}) = (-1)^l \sum_{(\sigma, \phi) \in S(l)^{(r)}} \left[\prod_{b \in C(\sigma)} p_{\phi(b)} \prod_{c \in C(\sigma\pi)} -q_{\psi(c)} \right].$$

□

5.2.3 New proof of the Stanley-Féray formula

Let λ be a Young diagram consisting of n boxes. In the following we will distinguish the symmetric group S_n which permutes the elements $\{1, \dots, n\}$ and the symmetric group \tilde{S}_n which permutes the boxes of λ .

For a box $\square \in \lambda$ we denote by $r(\square) \in \mathbb{N}$ (respectively, $c(\square) \in \mathbb{N}$) the row (respectively, the column) of \square ; in this way $\square = (c(\square), r(\square))$.

If $\sigma \in \tilde{S}_n$ has a property that if boxes \square_1, \square_2 are in the same row then $\sigma(\square_1), \sigma(\square_2)$ are not in the same column then we define the number of column inversions $\text{cinv}(\sigma)$ as the number of pairs \square_1, \square_2 such that $\sigma(\square_1), \sigma(\square_2)$ are in the same column, $r(\square_1) < r(\square_2)$ and $r(\sigma(\square_1)) > r(\sigma(\square_2))$. For $\sigma \in \tilde{S}_n$ which do not have this property we define $(-1)^{\text{cinv}(\sigma)} = 0$.

The following theorem gives a very esthetically appealing formula for the characters of the symmetric groups.

Theorem 5.5. *Let a Young diagram λ having n boxes and $\pi \in S_n$ be given. Let $\hat{\pi} \in \tilde{S}_n$ be a random permutation distributed with the uniform distribution on the conjugacy class defined by π . Then*

$$\chi^\lambda(\pi) = \mathbb{E}[(-1)^{\text{cinv}(\hat{\pi})}].$$

Proof: We denote

$$\begin{aligned} P_\lambda &= \{\sigma \in \tilde{S}_n : \sigma \text{ preserves each row of } \lambda\}, \\ Q_\lambda &= \{\sigma \in \tilde{S}_n : \sigma \text{ preserves each column of } \lambda\} \end{aligned}$$

and define

$$\begin{aligned} a_\lambda &= \sum_{\sigma \in P_\lambda} \sigma \in \mathbb{C}[\tilde{S}_n], \\ b_\lambda &= \sum_{\sigma \in Q_\lambda} (-1)^{|\sigma|} \sigma \in \mathbb{C}[\tilde{S}_n], \\ c_\lambda &= b_\lambda a_\lambda. \end{aligned}$$

It is well-known that $p_\lambda = \alpha_\lambda c_\lambda$ is an idempotent for a constant α_λ which will be specified later. Its image $V_\lambda = \mathbb{C}[\tilde{S}_n] p_\lambda$ under multiplication from the right on the regular representation gives a representation ρ^λ (where the symmetric group acts by left multiplication) associated to a Young diagram λ . It turns out that $\alpha_\lambda = \frac{\dim V_\lambda}{n!}$. It follows that for $\tilde{\pi} \in \tilde{S}_n$

$$\begin{aligned} n! \frac{\text{Tr } \rho^\lambda(\tilde{\pi})}{\dim V_\lambda} &= \frac{\text{Tr } \rho^\lambda(\tilde{\pi}^{-1})}{\alpha_\lambda} = \frac{1}{\alpha_\lambda} \sum_{\mu \in \tilde{S}_n} \langle \delta_\mu, \tilde{\pi}^{-1} \delta_\mu p_\lambda \rangle = \\ &= \sum_{\mu \in \tilde{S}_n} \sum_{\tilde{\sigma}_1 \in Q_\lambda} \sum_{\tilde{\sigma}_2 \in P_\lambda} (-1)^{|\tilde{\sigma}_1|} [\mu = \tilde{\pi}^{-1} \mu \tilde{\sigma}_1 \tilde{\sigma}_2]. \end{aligned} \quad (69)$$

We define $\hat{\pi} = \mu^{-1}\tilde{\pi}\mu$. For such a permutation $\hat{\pi}$ there exists at most one factorization $\hat{\pi} = \tilde{\sigma}_1\tilde{\sigma}_2$; by Young lemma this factorization exists if and only if $(-1)^{\text{cinv}(\hat{\pi})} \neq 0$. Furthermore, if such a factorization exists then $(-1)^{|\sigma_1|} = (-1)^{\text{cinv}(\sigma)}$. It follows that

$$n! \frac{\text{Tr } \rho^\lambda(\tilde{\pi})}{\dim V_\lambda} = \sum_{\mu \in \tilde{S}_n} (-1)^{\text{cinv}(\mu^{-1}\tilde{\pi}\mu)}.$$

As μ runs over all permutations, $\hat{\pi} = \mu^{-1}\tilde{\pi}\mu$ runs over all elements of the conjugacy class defined by π which finishes the proof. \square

For permutations $\sigma_1, \sigma_2 \in S_l$ we define $\tilde{N}^\lambda(\sigma_1, \sigma_2)$ as the number of one-to-one functions f from $\{1, \dots, l\}$ to the set of boxes of λ with a property that $r \circ f$ is constant on each cycle of σ_2 and $c \circ f$ is constant on each cycle of σ_1 .

Proposition 5.6. *Let λ be a Young diagram having n boxes. For any permutation $\pi \in S_l$ (where $l \leq n$)*

$$\Sigma^\lambda(\pi) = \sum_{\substack{\sigma_1, \sigma_2 \in S_l \\ \sigma_1\sigma_2 = \pi}} (-1)^{|\sigma_1|} \tilde{N}^\lambda(\sigma_1, \sigma_2).$$

Proof : Let us consider the case $l = n$. Let $\tilde{\pi} \in \tilde{S}_n$ be any permutation with the same cycle structure as $\pi \in S_n$. Our starting point is the analysis of (69). Notice that the multiset of the values of $\mu^{-1}\tilde{\pi}\mu$ (over $\mu \in S_n$) coincides with the multiset of the values of $f \circ \pi \circ f^{-1}$ (over bijections f). We define $\sigma_i = f^{-1} \circ \tilde{\sigma}_i \circ f$; then condition $\mu = \tilde{\pi}^{-1}\mu\tilde{\sigma}_1\tilde{\sigma}_2$ is equivalent to $\pi = \sigma_1\sigma_2$. It is easy to check that $\tilde{\sigma}_1 \in Q_\lambda$ if and only if $c \circ f$ is constant on each cycle of σ_1 and $\tilde{\sigma}_2 \in P_\lambda$ if and only if $r \circ f$ is constant on each cycle of σ_2 . Thus

$$n! \frac{\text{Tr } \rho^\lambda(\tilde{\pi})}{\dim V_\lambda} = \sum_{\substack{\sigma_1, \sigma_2 \in S_n, \\ \sigma_1\sigma_2 = \pi}} (-1)^{|\sigma_1|} \tilde{N}^\lambda(\sigma_1, \sigma_2) \quad (70)$$

and the proof in the case when $l = n$ is finished.

For a permutation $\sigma \in S_n$ we denote by $\text{supp } \sigma \subseteq \{1, \dots, n\}$ the support of a permutation (the set of non-fixed points). We claim that a factorization $\pi = \sigma_1\sigma_2$ has a non-zero contribution to (70) only if $\text{supp } \sigma_1, \text{supp } \sigma_2 \subseteq \text{supp } \pi$. Indeed, if $m \in \text{supp } \sigma_1 \setminus \text{supp } \pi = \text{supp } \sigma_2 \setminus \text{supp } \pi$ then for any bijection f at least one of the following conditions hold true : $r(f(m)) \neq r(f(\sigma_2(m)))$ (in this case $r \circ f$ is not constant on the cycles of σ_2) or $c(f(m)) \neq c(f(\sigma_2(m)))$ (in this case $c(f(\sigma_1(\sigma_2(m)))) \neq c(f(\sigma_2(m)))$) hence $c \circ f$ is not constant on the cycles of σ_1).

It follows that if $\pi \in S_l$ then we may restrict the sum in (70) to factorizations $\pi = \sigma_1\sigma_2$, where $\sigma_1, \sigma_2 \in S_l$ which finishes the proof. \square

For permutations $\sigma_1, \sigma_2 \in S_l$ we define $\hat{N}^\lambda(\sigma_1, \sigma_2)$ as the number of all functions $f : \{1, \dots, l\} \rightarrow \lambda$ (with values in the set of boxes of λ) with a property that $r \circ f$ is constant on each cycle of σ_2 and $c \circ f$ is constant on each cycle of σ_1 .

Lemma 5.7. *For any Young diagram λ and a permutation $\pi \in S_l$*

$$\sum_{\substack{\sigma_1, \sigma_2 \in S_l \\ \sigma_1 \sigma_2 = \pi,}} (-1)^{|\sigma_1|} \tilde{N}^\lambda(\sigma_1, \sigma_2) = \sum_{\substack{\sigma_1, \sigma_2 \in S_l \\ \sigma_1 \sigma_2 = \pi,}} (-1)^{|\sigma_1|} \hat{N}^\lambda(\sigma_1, \sigma_2). \quad (71)$$

Proof : Let a function $f : \{1, \dots, l\} \rightarrow \lambda$ be given which is not a one-to-one function. It follows that there exists a transposition $\mu \in S_l$ with a property that f is constant on the orbits of μ . Function f contributes to the sum

$$\sum_{\substack{\sigma_1, \sigma_2 \in S_l \\ \sigma_1 \sigma_2 = \pi,}} (-1)^{|\sigma_1|} \tilde{N}^\lambda(\sigma_1, \sigma_2)$$

with multiplicity

$$\sum_{\substack{\sigma_1, \sigma_2 \in S_l \\ \sigma_1 \sigma_2 = \pi}} (-1)^{|\sigma_1|}, \quad (72)$$

where the sum runs over pairs (σ_1, σ_2) with a property that $\sigma_1 \sigma_2 = \pi$ and $c \circ f$ is constant on each cycle of σ_1 and $r \circ f$ is constant on each cycle of σ_2 .

Map $(\sigma_1, \sigma_2) \mapsto (\sigma'_1, \sigma'_2)$ with $\sigma'_1 = \sigma_1 \mu$, $\sigma'_2 = \mu \sigma_2$ is an involution of the pairs (σ_1, σ_2) which contribute to (72); the only less trivial condition which should be verified is that $c \circ f$ is constant on each cycle of σ'_1 but this is equivalent to $c \circ f$ being constant on each cycle of $\sigma_1^{-1} = \mu \sigma_1^{-1}$.

Since $(-1)^{|\sigma_1|} = (-1) \cdot (-1)^{|\sigma'_1|}$ therefore the contributions of the pairs (σ_1, σ_2) and (σ'_1, σ'_2) to (72) cancel. In this way we proved that (72) is equal to zero which finishes the proof. \square

Proof : [Proof of Theorem 5.2] Proposition 5.6 and Lemma 5.7 show that

$$\Sigma^\lambda(\pi) = \sum_{\substack{\sigma_1, \sigma_2 \in S_l \\ \sigma_1 \sigma_2 = \pi}} (-1)^{|\sigma_1|} \hat{N}^\lambda(\sigma_1, \sigma_2).$$

Now it is enough to notice that $N^\lambda(\sigma_1, \sigma_2) = \hat{N}^\lambda(\sigma_1, \sigma_2)$; the desired bijection is defined as follows : if $m \in \{1, \dots, l\}$ fulfills $m \in c_1 \cap c_2$ for $c_i \in C(\sigma_i)$ we set $f(m) = (h(c_1), h(c_2))$. \square

5.2.4 Generalization to Young diagrams on \mathbb{R}_+^2

We may identify a Young diagram with a subset of \mathbb{R}^2 given by a graphical representation of λ (according to the French notation). For example, for a partition $\lambda = (\lambda_1, \dots, \lambda_k)$ it is the set

$$\bigcup_{1 \leq i \leq k} [0, \lambda_i] \times [i-1, i]. \quad (73)$$

In this way we may consider colorings h of the cycles of permutations σ_1 and σ_2 which instead of natural take real values. If we fix some numbering of the cycles in $C = C(\sigma_1) \sqcup C(\sigma_2)$ then any such coloring $h : C \rightarrow \mathbb{R}_+$ can be identified with an element of $\mathbb{R}_+^{|C|}$.

We define

$$N^\lambda(\sigma_1, \sigma_2) = \text{vol}\{h \in \mathbb{R}_+^{|C|} : h \text{ compatible with } \lambda\}. \quad (74)$$

Notice that in the case when $\lambda \subset \mathbb{R}^2$ is as prescribed by (73), the set of functions $h \in \mathbb{R}_+^{|\mathcal{C}|}$ compatible with λ is a polyhedron hence there is no difficulty in defining its volume; furthermore definitions (65) and (74) give the same value.

The advantage of the definition (74) is that it allows to define characters for any bounded set $\lambda \in \mathbb{R}_+^2$, in particular for multi-rectangular Young diagrams $\mathbf{p} \times \mathbf{q}$ for general sequences $p_1, \dots, p_k \geq 0, q_1, \dots, q_k \geq 0$ which do not have to be natural numbers—just like in the original papers [Sta03, Sta06, Fér08b].

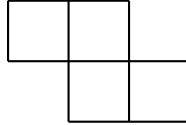

FIG. 5.2 – Example of a skew Young diagram for which Theorem 5.2 is false.

It is very natural therefore to ask if Theorem 5.2 holds true also for skew Young diagrams. Unfortunately, this is not the case as it can be seen for the skew Young diagram λ from Figure 5.2 since

$$\Sigma^\lambda(12) = 12 \frac{\text{Tr } \rho^\lambda(12)}{\text{Tr } \rho^\lambda(e)} = \frac{12}{5}$$

which is not even an integer!

5.3 Characters of symmetric groups, random matrices and free probability

5.3.1 Stanley-Féray character formula and random matrices

- For a Young diagram λ we consider a random matrix $T_\lambda = (t_{ij})$ such that
- its entries (t_{ij}) are independent random variables;
 - if $(i, j) \in \lambda$ then t_{ij} is a complex centered Gaussian variable, that is to say that

$$\begin{aligned} \mathbb{E}(t_{ij}) &= 0, \\ \mathbb{E}(t_{ij}\overline{t_{ij}}) &= 1, \\ \mathbb{E}(t_{ij}^2) &= 0; \end{aligned}$$

- otherwise, if $(i, j) \notin \lambda$ then $t_{ij} = 0$.

Since T_λ has only finitely many non-zero entries we may identify it with its truncation $T_\lambda = (t_{ij})_{1 \leq i, j \leq N}$, where $N \geq r(\lambda), c(\lambda)$.

We are interested in this matrix because the moments of $T_\lambda T_\lambda^*$ are given by a formula which is very similar to the Stanley-Féray formula for characters (Theorem 5.2) :

Theorem 5.8. *With the definitions above and $\pi \in S_l$ with a cycle decomposition k_1, \dots, k_r*

$$\mathbb{E}(\text{Tr}(T_\lambda T_\lambda^*)^{k_1} \dots \text{Tr}(T_\lambda T_\lambda^*)^{k_r}) = \sum_{\substack{\sigma_1, \sigma_2 \in S_l \\ \sigma_1 \sigma_2 = \pi}} N^\lambda(\sigma_1, \sigma_2). \tag{75}$$

Proof : The first step is to expand the product and the trace on the left-hand side :

$$\begin{aligned} & \mathbb{E}(\mathrm{Tr}(T_\lambda T_\lambda^*)^{k_1} \dots \mathrm{Tr}(T_\lambda T_\lambda^*)^{k_r}) \\ &= \mathbb{E} \left[\left(\sum_{i_1^1, j_1^1, \dots, i_{k_1}^1, j_{k_1}^1} t_{i_1^1 j_1^1} \overline{t_{i_2^1 j_1^1}} \dots t_{i_{k_1}^1 j_{k_1}^1} \overline{t_{i_1^1 j_{k_1}^1}} \right) \right. \\ & \quad \left. \dots \left(\sum_{i_1^r, j_1^r, \dots, i_{k_r}^r, j_{k_r}^r} t_{i_1^r j_1^r} \overline{t_{i_2^r j_1^r}} \dots t_{i_{k_r}^r j_{k_r}^r} \overline{t_{i_1^r j_{k_r}^r}} \right) \right] \\ &= \sum_{i_1, j_1, \dots, i_l, j_l} \mathbb{E} \left[\prod_{m=1}^l t_{i_m j_m} \overline{t_{i_{\pi(m)} j_m}} \right]. \end{aligned}$$

Since random variables (t_{ij}) are Gaussian we can apply Wick formula [Zvo97] to each summand ; in order to do this we need to consider all ways of pairing factors (t_{i_m, j_m}) with factors $(\overline{t_{i_{\pi(m)} j_m}})$. Each such a pairing can be identified with a permutation $\sigma \in S_l$ therefore

$$\begin{aligned} \mathbb{E} \left[\prod_{m=1}^l t_{i_m j_m} \overline{t_{i_{\pi(m)} j_m}} \right] &= \sum_{\sigma \in S_l} \left[\prod_{m=1}^l \mathbb{E} \left(t_{i_{\sigma(m)} j_{\sigma(m)}} \overline{t_{i_{\pi(m)} j_m}} \right) \right] = \\ & \sum_{\sigma \in S_l} \prod_{m=1}^l [i_{\sigma(m)} = i_{\pi(m)}] [j_{\sigma(m)} = j_m] [(i_{\sigma(m)}, j_{\sigma(m)}) \in \lambda]. \end{aligned}$$

If we plug this in our calculation,

$$\begin{aligned} \mathbb{E}(\mathrm{Tr}(T_\lambda T_\lambda^*)^{k_1} \dots \mathrm{Tr}(T_\lambda T_\lambda^*)^{k_r}) &= \\ & \sum_{\sigma \in S_l} \sum_{i_1, j_1, \dots, i_l, j_l} \left(\prod_{m=1}^l [i_{\sigma(m)} = i_{\pi(m)}] [j_{\sigma(m)} = j_m] [(i_{\sigma(m)}, j_{\sigma(m)}) \in \lambda] \right). \end{aligned}$$

If we denote $\sigma_1 = \pi \sigma_2^{-1}$, $\sigma_2 = \sigma$ then the sum over σ can be seen as a sum over all $\sigma_1, \sigma_2 \in S_l$ such that $\sigma_1 \sigma_2 = \pi$. If a sequence i_1, \dots, i_l (respectively, sequence j_1, \dots, j_l) contributes to the above sum then it must be constant on each cycle of σ_1 (respectively, each cycle of σ_2). It follows that there is a bijective correspondence between sequences $i_1, j_1, \dots, i_l, j_l$ which contribute to the above sum and colorings of the cycles of σ_1 and σ_2 which are compatible with λ . \square

By comparing the above result with Theorem 5.2 we obtain the following corollary.

Corollary 5.9. *Let λ be a Young diagram. Then for any permutation $\pi \in S_l$ with a cycle decomposition k_1, \dots, k_r*

$$|\Sigma^\lambda(\pi)| \leq \mathbb{E}(\mathrm{Tr}(T_\lambda T_\lambda^*)^{k_1} \dots \mathrm{Tr}(T_\lambda T_\lambda^*)^{k_r}).$$

We shall not follow this idea in this article and we will prove all estimates from scratch, but it is worth noticing that the above Corollary shows that the asymptotics of characters of symmetric groups can be deduced from the corresponding asymptotics of random matrices.

In particular it follows that when the lengths k_1, \dots, k_r of the cycles of π are big enough then the asymptotics of the corresponding character is related to the limit distribution of the largest eigenvalue of $T_\lambda T_\lambda^*$ [SS98]. Notice, however, that due to the minus sign in Theorem 5.2 and the resulting cancelations the character $|\Sigma^\lambda(\pi)|$ could, at least in principle, be much smaller than the appropriate moment of the random matrix $T_\lambda T_\lambda^*$.

5.3.2 Formal Young diagrams

In the same way as Theorem 5.2 implies Theorem 5.4 equation (75) implies the following result.

Corollary 5.10. *If $\lambda = \mathbf{p} \times \mathbf{q}$ is a multirectangular Young diagram (66) then*

$$\mathbb{E}(\mathrm{Tr}(T_\lambda T_\lambda^*)^{k_1} \dots \mathrm{Tr}(T_\lambda T_\lambda^*)^{k_r}) = \sum_{(\sigma, \phi) \in S(l)^{(r)}} \left[\prod_{b \in C(\sigma)} p_{\phi(b)} \prod_{c \in C(\sigma\pi)} q_{\psi(c)} \right]. \quad (76)$$

It is somewhat disturbing that both the right-hand side of the original Stanley-Féray formula (68) and the right-hand side of (76) are polynomials \mathbf{p} and \mathbf{q} and as such make sense for arbitrary values of \mathbf{p} and \mathbf{q} , in particular for negative values. If we allow use of such *formal Young diagrams* $\mathbf{p} \times \mathbf{q}$ (the term *generalized Young diagram* is already in use and it means *continuous Young diagram*) then the following result follows.

Theorem 5.11. *For any formal Young diagram $\mathbf{p} \times \mathbf{q}$ and a permutation $\pi \in S_l$ with a cycle decomposition k_1, \dots, k_r*

$$\Sigma^{\mathbf{p} \times \mathbf{q}}(\pi) = (-1)^l \mathbb{E}(\mathrm{Tr}(T_{\mathbf{p} \times (-\mathbf{q})} T_{\mathbf{p} \times (-\mathbf{q})}^*)^{k_1} \dots \mathrm{Tr}(T_{\mathbf{p} \times (-\mathbf{q})} T_{\mathbf{p} \times (-\mathbf{q})}^*)^{k_r}).$$

The authors of this article are still confused about the meaning of the above equality since (except for the case of an empty Young diagram) at least one of the formal Young diagrams $\mathbf{p} \times \mathbf{q}$, $\mathbf{p} \times (-\mathbf{q})$ does not make sense as a Young diagram.

5.3.3 Free cumulants of the transition measure

For a (continuous) Young diagram λ we denote by μ^λ its transition measure (which is a probability measure on the real line) [Ker93, Bia98] and by $R_m^\lambda := R_m(\mu^\lambda)$ we denote the m -th free cumulant of μ^λ . The importance of free cumulants R_m^λ in the study of the asymptotics of symmetric groups was pointed out by Biane [Bia98]. The following theorem gives a new formula for the free cumulants R_m^λ . It has a big advantage that it does not involve the notion of the transition measure and it is related directly with the shape of a Young diagram.

Theorem 5.12. *For any Young diagram λ*

$$R_{l+1}^\lambda = \sum_{\substack{\sigma_1, \sigma_2 \in S_l, \\ \sigma_1 \sigma_2 = (1, 2, \dots, l), \\ |\sigma_1| + |\sigma_2| = l}} (-1)^{|\sigma_1|} N^\lambda(\sigma_1, \sigma_2), \quad (77)$$

where the sum runs over minimal factorizations of a cycle of length l .

Proof : For a Young diagram λ and $c > 0$ we denote by $c\lambda$ the (generalized) Young diagram obtained from λ by similarity with scale c . A function f on the set of (generalized) Young diagrams is said to be homogeneous of degree m if

$$f(c\lambda) = c^m f(\lambda)$$

holds true for all choices of λ and c . Each free cumulant R_m is homogenous of degree m .

The value of the normalized character $\Sigma^\lambda(1, 2, \dots, l)$ on a cycle can be expressed as a polynomial (known as Kerov polynomial) in free cumulants $(R_m^\lambda : m \in \{2, 3, \dots\})$:

$$\Sigma^\lambda(1, 2, \dots, l) = R_{l+1}^\lambda + (\text{terms of lower degree})$$

therefore R_{l+1}^λ is the homogeneous part of $\Sigma^\lambda(1, 2, \dots, l)$ with degree $l+1$. We apply (64) for $\pi = (1, 2, \dots, l)$; it is easy to see that each summand on the right-hand side is homogeneous of degree $|C(\sigma_1)| + |C(\sigma_2)|$ which finishes the proof. \square

5.3.4 Generalized circular operators

Let \mathcal{D} be the algebra of continuous functions on \mathbb{R}_+ . We equip it with an expected value $\phi : \mathcal{D} \rightarrow \mathbb{C}$ given by $\phi(f) = \int_0^\infty f(t) dt$.

We consider an operator-valued probability space, which by definition is some $*$ -algebra \mathcal{A} such that $\mathcal{D} \subseteq \mathcal{A}$ and equipped with a conditional expectation $\mathbb{E} : \mathcal{A} \rightarrow \mathcal{D}$. For a given (generalized) Young diagram λ let $T \in \mathcal{A}$ be a generalized circular operator [VDN92, Spe98] with a covariance

$$\begin{aligned} [k(T, fT^*)](s) &= \int_{t:(t,s) \in \lambda} f(t) dt, \\ [k(T^*, fT)](s) &= - \int_{t:(s,t) \in \lambda} f(t) dt, \\ [k(T, fT)](s) &= 0, \\ [k(T^*, fT^*)](s) &= 0. \end{aligned} \tag{78}$$

Theorem 5.13. *For any (generalized) Young diagram λ*

$$R_{l+1}^\lambda = \phi[(T^*T)^l].$$

Proof : It is easy to check that for permutations σ_1, σ_2 which contribute to (77) the corresponding bipartite graph is a tree therefore the calculation of $N^\lambda(\sigma_1, \sigma_2)$ is particularly simple, namely it is a certain iterated integral. The same iterated integral appears in the nested evaluation of amalgamated free cumulants therefore $N^\lambda(\sigma_1, \sigma_2) = \pm \phi[k_{\sigma_2}(T^*, T, \dots, T^*, T)]$. The plus/minus sign is due to the minus sign in the covariance (78). It is easy to check that in fact

$$(-1)^{|\sigma_1|} N^\lambda(\sigma_1, \sigma_2) = \phi[k_{\sigma_2}(T^*, T, \dots, T^*, T)].$$

The moment-cumulant formula

$$\mathbb{E}[(T^*T)^l] = \sum_{\sigma \in \text{NC}_2} k_\sigma(T^*, T, \dots, T^*, T)$$

finishes the proof since there is a bijective correspondence between non-crossing pair partitions and the minimal factorizations. \square

Except for the minus sign on the right-hand side of (78) the covariance of T looks in the same way as the covariance of generalized circular operators corresponding to the limits of Gaussian band matrices [Shl96] which should not be surprising in the light of Theorem 5.8. We refer also to the articles [Śni03, DH04] where a similar circular operator is considered.

Due to the analytic machinery of free probability the calculation of the moments of T in a closed form is possible in many cases therefore Theorem 5.13 gives a practical method of calculating the free cumulants of the Young diagrams.

5.4 Technical estimates

5.4.1 Estimates for the number of colorings $N^\lambda(\sigma_1, \sigma_2)$

As we already mentioned in Example 5.1.5 to permutations σ_1, σ_2 we can associate a bipartite graph $C(\sigma_1) \sqcup C(\sigma_2)$ with an edge between $c_1 \in C(\sigma_1)$ and $c_2 \in C(\sigma_2)$ if $c_1 \cap c_2 \neq \emptyset$.

For a bipartite graph $G = C_1 \sqcup C_2$ (not necessarily arising from the above construction) and a Young diagram λ we define $N^\lambda(G)$ as the number of colorings h of the vertices of $C_1 \sqcup C_2$ which are compatible with the Young diagram λ (the definition of compatibility in this context is a natural extension of the old one, i.e. we require that if $c_1 \in C_1$ and $c_2 \in C_2$ are connected by an edge then $(h(c_1), h(c_2)) \in \lambda$).

We denote by $G_{p,q}$ a full bipartite graph for which $|C_1| = p$ and $|C_2| = q$.

Lemma 5.14. *Let G be a finite bipartite graph with a property that the degree of any vertex is non-zero. It is possible (not necessarily in a unique way) to remove some of the edges of G in such a way that the resulting graph \tilde{G} is a disjoint union of the graphs of the form $G_{1,1}$, $G_{k,1}$, $G_{1,k}$.*

Assume that a Young diagram λ consists of n boxes. Then, for any $A \geq r(\lambda), c(\lambda)$

$$N^\lambda(G) \leq A^{(\text{number of vertices of } G)} \left(\frac{n}{A^2} \right)^{(\text{number of connected components of } \tilde{G})}. \quad (79)$$

Proof: If the graph G contains an edge which connects two vertices of degree bigger than one we remove it and iterate this procedure; if no such edge exists then the resulting graph \tilde{G} has the desired property.

Clearly, $N^\lambda(G) \leq N^\lambda(\tilde{G})$ therefore it is enough to find a suitable upper bound for $N^\lambda(\tilde{G})$. Since both sides of (79) are multiplicative with respect to the disjoint sum of graphs it is enough to prove (79) for $\tilde{G} \in \{G_{1,1}, G_{k,1}, G_{1,k}\}$. It is easy to verify that

$$\begin{aligned} N^\lambda(G_{1,1}) &= n, \\ N^\lambda(G_{k,1}) &= \sum_i \lambda_i^k \leq A^{k-1}n, \\ N^\lambda(G_{1,k}) &= \sum_i \lambda_i'^k \leq A^{k-1}n \end{aligned}$$

which finishes the proof. \square

Proposition 5.15. *Suppose that $r(\lambda), c(\lambda) \leq A \leq n$ and $\sigma_1, \sigma_2 \in S_l$ and $\pi = \sigma_1\sigma_2$. Then*

$$N^\lambda(\sigma_1, \sigma_2) \leq A^{|C(\sigma_1)|+|C(\sigma_2)|} \left(\frac{n}{A^2}\right)^{\text{orbits}(\sigma_1, \sigma_2)} \leq A^{l-|C(\pi)|} n^{|C(\pi)|} \left(\frac{1}{A}\right)^{o(\sigma_1, \sigma_2)}, \quad (80)$$

where $\text{orbits}(\sigma_1, \sigma_2)$ denotes the number of orbits in the action of $\langle \sigma_1, \sigma_2 \rangle$ on the set $\{1, \dots, n\}$ and

$$o(\sigma_1, \sigma_2) = l - |C(\sigma_1)| - |C(\sigma_2)| + \text{orbits}(\sigma_1, \sigma_2).$$

Proof : The first inequality is a simple corollary from Lemma 5.14 since $A^2 \geq r(\lambda)c(\lambda) \geq n$ and the number of connected components of \tilde{G} is bounded from below by $\text{orbits}(\sigma_1, \sigma_2)$. The second inequality follows by multiplying by

$$\left(\frac{n}{A}\right)^{|C(\pi)|-\text{orbits}(\sigma_1, \sigma_2)} \geq 1.$$

\square

5.4.2 Estimates for the number of factorizations

Now, we have to find a bound of the number of factorizations of π with a given value of the statistic $o(\sigma_1, \sigma_2)$.

Lemma 5.16. *Let $\pi, \sigma_1, \sigma_2 \in S_l$ be such that $\pi = \sigma_1\sigma_2$. There exist permutations $\sigma'_1, \sigma'_2 \in S_l$ such that $\pi = \sigma'_1\sigma'_2$, $|\sigma'_1| + |\sigma'_2| = |\sigma_1| + |\sigma_2|$, $|\sigma'_2| = |\sigma'_2\sigma_2^{-1}| + |\sigma_2|$ and every cycle of σ'_1 is contained in some cycle of σ'_2 . Furthermore, $|\sigma'_1| = o(\sigma_1, \sigma_2)$.*

Proof : If every cycle of σ_1 is contained in some cycle of σ_2 then $\sigma'_1 = \sigma_1$ and $\sigma'_2 = \sigma_2$ have the required property.

Otherwise, there exist $a, b \in \{1, \dots, n\}$ such that a and b belong to the same cycle of σ_1 but not to the same cycle of σ_2 . We define $\sigma'_1 = \sigma_1(a, b)$, $\sigma'_2 = (a, b)\sigma_2$. Notice that $|\sigma'_1| = |\sigma_1| - 1$, $|\sigma'_2| = |\sigma_2| + 1$, and the partitions Π and Π' of $\{1, \dots, l\}$ in the orbits under the action of the subgroups $\langle \sigma_1, \sigma_2 \rangle$ and $\langle \sigma'_1, \sigma'_2 \rangle$ are the same.

We iterate this procedure if necessary (it will finish after a finite number of steps because the length of σ_1 decreases in each step). It remains to prove that $|\sigma'_2| \geq |\sigma'_2\sigma_2^{-1}| + |\sigma_2|$ (the opposite inequality follows from the triangle inequality) : notice that $|\sigma'_2| - |\sigma_2|$ is equal to k (where k is the number of steps after which the procedure has terminated) and $\sigma'_2\sigma_2^{-1}$ is a product of k transpositions, hence $|\sigma'_2\sigma_2^{-1}| \leq k$.

Furthermore, as every cycle of σ'_1 is contained in some cycle of σ'_2 , the partition Π' is just $C(\sigma'_2)$, so $|C(\sigma'_2)| = \text{orbits}(\sigma'_1, \sigma'_2)$ therefore

$$o(\sigma_1, \sigma_2) = o(\sigma'_1, \sigma'_2) = l - |C(\sigma'_1)| = |\sigma'_1|.$$

\square

Lemma 5.17. *For any integers $l \geq 1$ and $i \geq 0$ and for any $\pi \in S_l$*

$$\#\{\sigma \in S_l : |\sigma| = i\} \leq \frac{l^{2i}}{i!}. \quad (81)$$

Proof : Since every permutation in S_l appears exactly once in the product

$$[1 + (12)][1 + (13) + (23)] \cdots [1 + (1l) + \cdots + (l-1, l)],$$

we have

$$\sum_i x^i \#\{\sigma \in S_l : |\sigma| = i\} = (1+x)(1+2x) \cdots (1+(l-1)x).$$

Each of the coefficients of x^k on the right-hand side is bounded from above by the corresponding coefficient of $e^x e^{2x} \cdots e^{(l-1)x} = e^{\frac{l(l-1)x}{2}}$, finishing the proof. \square

Lemma 5.18. *There exists a constant C_0 with a property that for any k the number of minimal factorisations $\sigma_1 \sigma_2 = \pi$, $|\sigma_1| + |\sigma_2| = |\pi|$ of a cycle $\pi = (1, \dots, k)$ and such that the associated graph \tilde{G} consists of $s \geq 2$ components is bounded from above by*

$$\frac{(C_0 k)^{2s-2}}{(2s-2)!}.$$

Proof : Since the factorization is minimal therefore the graph G associated to σ_1, σ_2 is a tree.

In each connected component of \tilde{G} there is at most one vertex of degree higher than one and we shall decorate this vertex. If in some connected component of \tilde{G} there are no such vertices we decorate any of them. In this way the decorated vertices can be identified with connected components of \tilde{G} .

We will give to G a structure of planted planar tree : the root is the cycle of σ_1 containing 1 and his left-most edge links it to the cycle of σ_2 containing 1.

We consider the graph G' obtained from G by removing the leaves (except the root) and the graph G'' which consists of the decorated vertices of \tilde{G} ; we connect two vertices $A, B \in G''$ by an edge if vertices A, B are connected in G (or, equivalently, G') by a *direct path*, i.e. a path which does not pass through any connected component of \tilde{G} other than the ones specified by A and B . It is easy to see that G'' inherits the structure of a plane rooted tree from G (we define the root of G'' to be the connected component of \tilde{G} of the root of G) and it has s vertices. It follows that the number of such trees G'' is bounded from above by the Catalan number $\frac{1}{s+1} \binom{2s}{s} < 4^s$.

In order to reconstruct tree G' from G'' we have to specify for each edge of G'' if it comes from a single edge of G' or from a pair or a triple of consecutive edges of G' ; it follows that we have (at most) 3^{s-1} choices. It might happen also for two adjacent (with respect to the planar structure) edges e_1, e_2 of G'' that each of these edges e_i corresponds to a pair or a triple of consecutive edges $f_i = (f_{i1}, f_{i2}, f_{i3})$ of G' and these tuples f_1 and f_2 have one edge in common. There are at most $2s-3$ such pairs of adjacent edges which accounts for at most 2^{2s-3} choices. If the root of G is not a decorated vertex, it might happen that it is a leaf or that it belong to the left-most and/or to the right-most edge of the root of G' : there are 4 choices for that.

In order to reconstruct tree G from G' we have to specify if the root of G is a decorated vertex or not. Furthermore we have to specify places in which we will add missing l leaves to the tree G' (note that $l \leq k + 1 - s$); it is easy to see that this is equivalent to specifying a partition $l = a_1 + \dots + a_{2s-1}$, where $a_1, \dots, a_{2s-1} \geq 0$ are integers. It follows that the number of choices is bounded from above by

$$2 \binom{l + 2s - 2}{2s - 2} \leq 2 \binom{k + s - 1}{2s - 2} \leq 2 \frac{k^{2s-2}}{(2s - 2)!}.$$

A minimal factorisation is determined by its bicolored graph with a marked edge, for example the one linking the two cycles containing 1 [GJ92]. With our construction, the coloring is determined by the root which is always white (i.e. a cycle of σ_1) and the marked edge is its left-most edge.

It follows that the total number of choices is bounded from above by

$$2 \cdot 3^{s-1} \cdot 2^{2s-1} \cdot 4^s \frac{k^{2s-2}}{(2s - 2)!}.$$

□

5.5 Asymptotics of characters

5.5.1 Upper bound for characters : proof of Theorem 5.1

Proof : [Proof of Theorem 5.1] Let $k_1, \dots, k_r \geq 2$ be the lengths of the non-trivial cycles in the cycle decomposition of $\pi \in S_n$. It follows that $l := k_1 + \dots + k_r = |\text{supp } \pi|$ and in the following we will regard π as an element of S_l . We denote $A = \max(l, r(\lambda), c(\lambda))$.

We consider a map which to a pair (σ_1, σ_2) associates any pair (σ'_1, σ'_2) as prescribed by Lemma 5.16. For any fixed σ'_2 the permutations σ_2 such that $|\sigma'_2| = |\sigma'_2 \sigma_2^{-1}| + |\sigma_2|$ can be identified with non-crossing partitions of the cycles of σ'_2 (see [Bia97, Section 1.3]). It follows that the number of such permutations σ_2 is equal to the product of appropriate Catalan numbers and, hence, this product is bounded from above by 4^l . Therefore Theorem 5.2 and Proposition 5.15 show that

$$\begin{aligned} |\Sigma^\lambda(\pi)| &\leq \sum_{\substack{\sigma_1, \sigma_2 \in S_l, \\ \sigma_1 \sigma_2 = \pi}} A^{l-r} n^r \left(\frac{1}{A}\right)^{o(\sigma_1, \sigma_2)} \leq 4^l \sum_{\substack{\sigma'_1, \sigma'_2 \in S_l, \\ \sigma'_1 \sigma'_2 = \pi}} A^{l-r} n^r \left(\frac{1}{A}\right)^{|\sigma'_1|} \\ &\leq 4^l A^{l-r} n^r \sum_{\sigma'_1 \in S_l} \left(\frac{1}{A}\right)^{|\sigma'_1|} \leq 4^l A^{l-r} n^r \sum_{i \geq 0} \frac{l^{2i}}{A^i i!}, \end{aligned}$$

where the last inequality follows from Lemma 5.17. It follows that

$$|\Sigma^\lambda(\pi)| \leq 4^l A^{l-r} n^r e^{\frac{l^2}{A}} \leq (4e)^l A^{l-r} n^r. \quad (82)$$

After dividing by $(n)_l \geq \left(\frac{n}{e}\right)^l$ we obtain

$$|\chi^\lambda(\pi)| \leq (4e^2)^l \left(\frac{A}{n}\right)^{l-r} \quad (83)$$

which finishes the proof because $l = |\text{supp } \pi| \leq 2|\pi|$ and $l - r = |\pi|$. \square

5.5.2 Error term for balanced Young diagrams

Biane [Bia98] proved that if the permutation π is fixed and the Young diagram λ is balanced (i.e. $r(\lambda), c(\lambda) = O(\sqrt{n})$) then

$$\chi^\lambda(\pi) = \frac{1}{(n)_{|\text{supp}(\pi)|}} \prod_{i=1}^r R_{k_i+1}(\lambda) + O\left(n^{-\frac{|\pi|+2}{2}}\right).$$

The following theorem gives a uniform estimate for the error term in Biane's formula (note that if π is fixed and the Young diagram balanced, with $\epsilon = \frac{C}{\sqrt{n}}$ we recover the result of Biane).

Theorem 5.19. *There exists a constant a such that, for any $0 < \epsilon < 1$, any Young diagram λ of size n and any permutation $\pi \in S_n$ such that $|\text{supp}(\pi)|^2 \leq \epsilon A$ and $r(\lambda), c(\lambda) \leq A \leq n$ we have :*

$$\left| \chi^\lambda(\pi) - \frac{1}{(n)_{|\text{supp}(\pi)|}} \prod_{i=1}^r R_{k_i+1}(\lambda) \right| \leq \left(\epsilon^2 + \frac{A}{n} \epsilon \right) \left(\frac{aA}{n} \right)^{|\pi|},$$

where the k_i are the lengths of the non-trivial cycles of π .

Proof : Using Theorem 5.2 and Theorem 5.12 together with the fact that any minimal factorisation of π is a product of minimal factorisations of its cycles, we can write :

$$\Sigma^\lambda(\pi) - \prod_{i=1}^r R_{k_i+1}^\lambda = \sum_{\substack{\sigma_1, \sigma_2 \in S_l \\ \sigma_1 \sigma_2 = \pi \\ |\sigma_1| + |\sigma_2| > |\pi|}} (-1)^{|\sigma_1|} N^\lambda(\sigma_1, \sigma_2),$$

where $l = |\text{supp } \pi|$ is the support of π . To such a pair (σ_1, σ_2) of permutations we can associate one of the pairs of permutations (σ'_1, σ'_2) given by Lemma 5.16 with $|\sigma'_1| \geq 1$.

Consider the case $|\sigma'_1| = 1$. Then $\text{orbits}(\sigma_1, \sigma_2) = \text{orbits}(\sigma'_1, \sigma'_2) \geq |C(\pi)| - 1$ and the first inequality in (80) shows that

$$N^\lambda(\sigma_1, \sigma_2) \leq A^{|\sigma_1| + |\sigma_2|} \left(\frac{n}{A^2} \right)^{|C(\pi)| - 1}$$

therefore the estimate given by Proposition 5.15 can be improved to the following one :

$$N^\lambda(\sigma_1, \sigma_2) \leq A^{l - |C(\pi)|} n^{|C(\pi)|} \frac{1}{n}.$$

Clearly $A \geq l$ therefore by the same argument as in the proof of Theorem 5.1, we obtain the inequality

$$\left| \Sigma^\lambda(\pi) - \prod_{i=1}^r R_{k_i+1}(\lambda) \right| \leq 4^l A^{l-r} n^r \left(\frac{l^2}{n} + \sum_{i \geq 2} \frac{l^{2i}}{A^i i!} \right).$$

The proof is now finished thanks to the remarks of the previous subsection and the inequality $\exp(z) - 1 - z \leq z^2$ for $0 < z < 1$. \square

5.5.3 Characters of symmetric groups related to Thoma characters

Vershik and Kerov [VK81] proved that if π is a fixed permutation with the lengths of non-trivial cycles k_1, \dots, k_r then for any Young diagram λ with n boxes

$$\chi^\lambda(\pi) = \prod_{i=1}^r \left[\sum_j \alpha_j^{k_i} - \sum_j (-\beta_j)^{k_i} \right] + O\left(\frac{1}{n}\right)$$

where $\alpha_j = \frac{\lambda_j}{n}$, $\beta_j = \frac{\lambda'_j}{n}$; we prefer to write this formula in an equivalent form

$$\chi^\lambda(\pi) = \frac{n^l}{(n)_l} \prod_{i=1}^r \left[\sum_j \alpha_j^{k_i} - \sum_j (-\beta_j)^{k_i} \right] + O\left(\frac{1}{n}\right). \quad (84)$$

In this section we will prove Theorem 5.20 which together with Theorem 5.19 give a uniform estimate for the error term in the formula (84). In particular, for $A = n$ and $\epsilon = \frac{C}{n}$ we recover the result of Vershik and Kerov.

Theorem 5.20. *There exist constants $a, C > 0$ with the following property. Let k_1, \dots, k_r be positive integers; we denote $k_1 + \dots + k_r = l$. If λ is a Young diagram having n boxes with less than A boxes in each row and each column and such that $\epsilon = \frac{(k_1^2 + \dots + k_r^2)n}{A^2} < C$ then*

$$\left| \frac{\prod_{i=1}^r R_{k_i+1}^\lambda}{n^l} - \prod_{i=1}^r \left[\sum_j \alpha_j^{k_i} - \sum_j (-\beta_j)^{k_i} \right] \right| \leq \epsilon \left(\frac{A}{n}\right)^{l-r} a^r, \quad (85)$$

where $\alpha_j = \frac{\lambda_j}{n}$, $\beta_i = \frac{\lambda'_i}{n}$.

Proof : Firstly, let us consider the case $r = 1$. Note that

$$\begin{aligned} N^\lambda(e, (1, \dots, k)) &= \sum_j (n\alpha_j)^k, \\ N^\lambda((1, \dots, k), e) &= \sum_j (n\beta_j)^k \end{aligned}$$

therefore Theorem 5.12 implies that the left-hand side of (85) is equal to

$$\left| \frac{1}{n^k} \sum_{\substack{\sigma_1, \sigma_2 \in S_k \setminus \{e\} \\ \sigma_1 \sigma_2 = \pi \\ |\sigma_1| + |\sigma_2| = |\pi|}} (-1)^{|\sigma_1|} N^\lambda(\sigma_1, \sigma_2) \right|.$$

Let a pairs of permutations σ_1, σ_2 which contribute to the above sum be fixed; we consider the bipartite graph G and the graph \tilde{G} given by Lemma 5.14. Clearly, in this case graph \tilde{G} has more than one component. With Lemma 5.18 and Lemma 5.14

$$\left(\frac{n}{A}\right)^{k-1} \left| \frac{R_{k+1}^\lambda}{n^k} - \sum_j (\alpha_j^k - (-\beta_j)^k) \right| \leq \sum_{s \geq 2} \frac{(C_0 k)^{2s-2}}{(2s-2)!} \left(\frac{n}{A^2}\right)^{s-1} \leq \frac{2C_0^2 k^2 n}{A^2} = 2C_0^2 \epsilon, \quad (86)$$

where the last inequality holds true if $\frac{2C_0^2 k^2 n}{A^2} = 2C_0^2 \varepsilon$ is smaller than some positive constant and the proof is finished in the case $r = 1$.

For the general case, we put $\epsilon_i = \frac{k_i^2 n}{A^2}$. We denote

$$\begin{aligned} X_i &= \frac{1}{a} \left(\frac{n}{A}\right)^{k_i-1} \frac{R_{k_i+1}^\lambda}{n^{k_i}}, \\ Y_i &= \frac{1}{a} \left(\frac{n}{A}\right)^{k_i-1} \sum_j (\alpha_j^{k_i} - (-\beta_j)^{k_i}). \end{aligned}$$

Let us fix $a > 2$. Clearly, $|Y_i| < \frac{2}{a} < 1$ hence (86) shows that $|X_i| < 1$ if ε is smaller than some positive constant. Telescopic summation

$$\begin{aligned} X_1 \cdots X_r - Y_1 \cdots Y_r &= X_1 \cdots X_{r-1} (X_r - Y_r) + \\ &\quad X_1 \cdots X_{r-2} (X_{r-1} - Y_{r-1}) Y_r + \cdots + (X_1 - Y_1) Y_2 \cdots Y_r \end{aligned}$$

shows that

$$\frac{1}{a^r} \left(\frac{n}{A}\right)^{l-r} \left| \frac{\prod_{i=1}^r R_{k_i+1}^\lambda}{n^l} - \prod_{i=1}^r \left[\sum_j \alpha_j^{k_i} - \sum_j (-\beta_j)^{k_i} \right] \right| \leq \frac{2C_0(\epsilon_1 + \cdots + \epsilon_r)}{a}.$$

□

5.5.4 Disjoint cumulants of conjugacy classes

Since this section is not central to the this paper we will be quite condensed with presenting the necessary definitions. For more details we refer to [Šni06c].

For any permutation $\pi \in S_l$ we consider the normalized conjugacy class $\Sigma_\pi \in S_n$. For normalized conjugacy classes $\Sigma_{\pi_1}, \dots, \Sigma_{\pi_r}$ we consider their *disjoint cumulant* $k^\bullet(\Sigma_{\pi_1}, \dots, \Sigma_{\pi_r})$ with respect to some given representation ρ of S_n .

One of the main results of the paper [Šni06c] was asymptotics of the disjoint cumulant $k^\bullet(\Sigma_{\pi_1}, \dots, \Sigma_{\pi_r})$ in the case when π_1, \dots, π_r are fixed and the Young diagram λ is balanced. The following Proposition (after applying similar estimates as in the proof of Theorem 5.1) gives a uniform estimate for such disjoint cumulants.

Proposition 5.21. *Let $\pi_1 \in S_{l_1}, \dots, \pi_r \in S_{l_r}$. If $\rho = \rho^\lambda$ is an irreducible representation corresponding to the Young diagram λ then*

$$k^\bullet(\Sigma_{\pi_1}, \dots, \Sigma_{\pi_r}) = \sum_{\substack{\sigma_1, \sigma_2 \in S_{l_1+\dots+l_r}, \\ \sigma_1 \sigma_2 = \pi_1 \times \dots \times \pi_r, \\ \langle \sigma_1, \sigma_2, S_{l_1} \times \dots \times S_{l_r} \rangle \text{ is transitive}}} (-1)^{|\sigma_1|} N^\lambda(\sigma_1, \sigma_2),$$

where the sum runs over all factorizations $\sigma_1 \sigma_2 = \pi_1 \cdots \pi_r \in S_{l_1+\dots+l_r}$ which are transitive in a sense that the permutations σ_1, σ_2 together with $S_{l_1} \times \dots \times S_{l_r}$ act transitively on $\{1, \dots, l_1 + \dots + l_r\}$.

Proof : It is an immediate consequence of Theorem 5.2 and the definition of the disjoint cumulants. □

Troisième partie

Étude combinatoire des coefficients des polynômes de Kerov

6

Combinatorial interpretation and positivity of Kerov's character polynomials

Ce chapitre reprend le contenu de l'article [Fér08a], à paraître dans *Journal of Algebraic Combinatorics*. Une version abrégée a été acceptée à la conférence internationale FPSAC 2008 (prix du meilleur papier d'un étudiant).

This chapter corresponds to the article [Fér08a], to appear in *Journal of Algebraic Combinatorics*. A short version has also been accepted at FPSAC 2008 (best paper from a student award).

Résumé

Les polynômes de Kerov permettent d'exprimer les caractères irréductibles en fonction des cumulants libres associés au diagramme de Young. Dans cet article, nous établissons un résultat de positivité sur les coefficients, qui étend une conjecture de S.V. Kerov.

La méthode utilisée, via la décomposition de cartes, donne une description des coefficients du k -ième polynôme de Kerov à partir des permutations de $S(k)$. Nous obtenons aussi des formules explicites et des interprétations combinatoires pour certains coefficients. En particulier, nous calculons le terme sous-dominant du caractère sur une permutation fixée (ce résultat était connu seulement dans le cas des cycles).

Abstract

Kerov's polynomials give irreducible character values in term of the free cumulants of the associated Young diagram. We prove in this article a positivity result on their coefficients, which extends a conjecture of S. Kerov.

Our method, through decomposition of maps, gives a description of the coefficients of the k -th Kerov's polynomials using permutations in $S(k)$. We also obtain explicit formulas or combinatorial interpretations for some coefficients. In particular, we are able to compute the subdominant term for character values on any fixed permutation (it was known for cycles).

6.1 Introduction

6.1.1 Background

6.1.1.1 Representations of the symmetric group

Representations theory of the symmetric group $S(n)$ is a very ancient research field in mathematics. Irreducible representations of $S(n)$ are indexed by partitions λ of n , or equivalently by Young diagrams of size n . The associated character can be computed thanks to a combinatorial algorithm, but unfortunately it becomes quickly cumbersome when the size of the diagram is large and does not help to study asymptotic behaviours.

6.1.1.2 Free cumulants

To solve asymptotic problems in representation theory of the symmetric groups, P. Biane introduced in [Bia98] the free cumulants $R_i(\lambda)$ (of the transition measure) of a Young diagram. Asymptotically, the character value and the classical operation on representations can be easily described with free cumulants :

- Up to a good normalisation, the $l + 1$ -th free cumulant is the leading term of the character value on the cycle $(1 \dots l)$.
- Typical large Young diagrams (according to the Plancherel distribution) have, after rescaling, all their free cumulants, excepted from the second one, very close to zero.
- Almost all the diagrams appearing in an elementary operation on irreducible representations (like restriction, tensor product) have free cumulants very close to specific values, which can be easily computed from the free cumulants of the original diagram(s).

So the free cumulants form a good way to encode the informations contained in a Young diagram.

6.1.1.3 Kerov's polynomials

It is natural to wonder if there are exact expressions of character value in terms of free cumulants. Kerov's polynomials give a positive answer to this question for character values on cycles (they appear first in a paper of P. Biane [Bia03, Theorem 1.1] in 2003). Unfortunately, their coefficients remain very mysterious. A lot of work has been done to understand them ([Bia03],[Śni06a],[GR07],[Bia07],[RŚ08],[Las08d]) : a general, but exploding in complexity, explicit formula and a combinatorial interpretation for linear terms in free cumulants have been found.

The positivity of the coefficients of Kerov's polynomial has been observed by numerical computations ([Bia03],[GR07]) and was conjectured by S. Kerov. The main result of this paper is a positive answer to this conjecture.

6.1.1.4 Multirectangular Young diagrams

We use in this paper a new way to look at Young diagrams, initiated by R. Stanley in [Sta03]. In this paper, he proved a nice combinatorial formula for character values, but only for Young diagrams of rectangular shape. To generalize it, we have to look at any Young diagram as a superposition of rectangles as in figure 6.1. With this description, Stanley's formula has been recently generalized (see [Sta06],[Fér08b]).

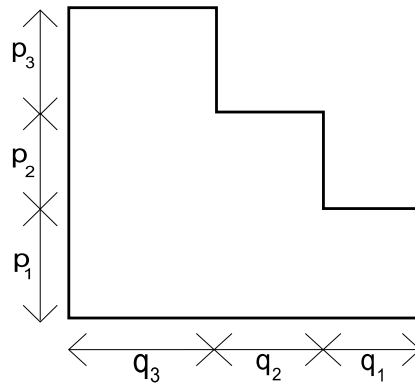

FIG. 6.1 – Young diagram associated to sequences \mathbf{p} and \mathbf{q} (french convention)

The complexity of this general formula depends only on the size of the support of the permutation (and not of the size of the permutation itself!). As remarked in [FŠ07], it is useful to reformulate it with the notion of bipartite graph associated to a pair of permutations. This bipartite graph has in fact a canonical map structure (for some pairs of permutations, this structure was introduced by I.P. Goulden and D.M. Jackson in [GJ92]), which is central here.

In this paper, we link these two recent developments. This gives a new combinatorial interpretation of the coefficients, proving Kerov's conjecture.

6.1.2 Normalized character

If σ is a permutation in $S(k)$, let $C(\sigma)$ be the partition of the set $[k] := \{1, \dots, k\}$ in orbits under the action of σ . The type of σ is, by definition, the partition μ of the integer k whose parts are the length of the cycle of σ . The conjugacy classes of $S(k)$ are exactly the sets of partition of a given type.

By definition, for $\mu \vdash k$ and $\lambda \vdash n$ with $k \leq n$, the normalized character value is given by equation :

$$\Sigma_{\mu}(\lambda) := \frac{n(n-1)\dots(n-k+1)\chi^{\lambda}(\sigma)}{\chi^{\lambda}(Id_n)}, \quad (87)$$

where σ is a permutation in $S(k)$ of type μ and χ^{λ} is the character value of the irreducible representation associated to λ (see [Mac95]). Note that we have to identify σ with its image by the natural embedding of $S(k)$ in $S(n)$ to compute $\chi^{\lambda}(\sigma)$.

6.1.3 Minimal factorizations and non-crossing partitions

Non-crossing partitions and in particular, their link with minimal factorizations of a cycle, are central in this work. This paragraph is devoted to definition and known results in this domain. For more details, see P. Biane's paper [Bia97].

Définition 6.1. A crossing of a partition π of the set $[j]$ is a quadruple $(a, b, c, d) \in [j]^4$ with $a < b < c < d$ such that

- a and c are in the same part of π ;
- b and d are in the same part of π , different from the one containing a and c .

A partition without crossings is called a non-crossing partition. The set of non-crossing partitions of $[j]$ is denoted $NC(j)$ and can be endowed with a partial order structure (by definition, $\pi \leq \pi'$ if every part of π is included in some part of π').

The partially ordered set (poset) $NC(j)$ appears in many domains : we will use its connection with the symmetric group.

Let us consider the following length on the symmetric group $S(j)$: denote by $l(\sigma)$ the minimal number h of transpositions needed to write σ as a product of transpositions $\sigma = \tau_1 \dots \tau_h$. One has :

$$\begin{aligned} l(Id_j) &= 0, \\ l(\sigma^{-1}) &= l(\sigma), \\ l(\sigma \cdot \sigma') &\leq l(\sigma) + l(\sigma'). \end{aligned}$$

We consider the associated partial order on $S(j)$: by definition, $\sigma \leq \sigma'$ if $l(\sigma') = l(\sigma) + l(\sigma^{-1}\sigma')$. It is easy to prove that

- Id_j is the smallest element ;
- for any σ , one has $l(\sigma) = j - |C(\sigma)|$.

So, if we denote by $(1 \dots j)$ the cycle sending 1 onto 2, 2 onto 3, etc. . . . , one has

$$\sigma \leq (1 \dots j) \iff |C(\sigma)| + |C(\sigma^{-1}(1 \dots j))| = j + 1.$$

If $\sigma \leq \sigma'$, let us consider the interval $[\sigma; \sigma']$ which is by definition the set $\{\tau \in S(k) \text{ s.t. } \sigma \leq \tau \leq \sigma'\}$. In his paper [Bia97, section 1.3], P. Biane gives a combinatorial description of these intervals :

Proposition 6.1 (Isomorphism with minimal factorizations). *The map*

$$\begin{aligned} [Id_j; (1 \dots j)] &\longrightarrow NC(j) \\ \sigma &\mapsto C(\sigma) \end{aligned}$$

is a poset isomorphism.

Here is the inverse bijection : to a non-crossing partition τ of $[j]$, we associate the permutation $\sigma_\tau \in S(j)$, where $\sigma_\tau(i)$ is the next element in the same part of τ as i for the cyclic order $(1, 2, \dots, j)$.

Since the order is invariant by conjugacy, every interval $[Id_j; c]$, where c is a full cycle, is isomorphic as poset to a non-crossing partition set. More generally, if σ is a permutation in $S(j)$,

$$[Id_j; \sigma] \simeq \prod_{i=1}^{|\mathcal{C}(\sigma)|} NC(j_i),$$

where the j_i 's are the number of elements of the cycles of σ . This result gives a description of all intervals of the symmetric group since, if $\sigma \leq \sigma'$, we have $[\sigma; \sigma'] \simeq [Id; \sigma^{-1}\sigma']$.

6.1.4 Kerov's polynomials

We look for an expression of the normalized character value in terms of free cumulants. In the case where μ has only one part ($\mu = (k), \sigma = (1 \dots k)$), P. Biane shows in [Bia03] the following result attributed by him to S. V. Kerov :

Definition-Theorem 6.2. *For any $k \geq 1$, there exists a polynomial K_k , called k -th Kerov's polynomial, with integer coefficients, such that, for every Young diagram λ of size bigger than k , one has :*

$$\Sigma_k(\lambda) = K_k(R_2(\lambda), \dots, R_{k+1}(\lambda)). \quad (88)$$

Examples :	$\Sigma_3 = R_4 + R_2;$
$\Sigma_1 = R_2;$	$\Sigma_4 = R_5 + 3R_3;$
$\Sigma_2 = R_3;$	$\Sigma_5 = R_6 + 15R_4 + 5R_2^2 + 8R_2.$

Our main result is the positivity of the coefficients of Kerov's polynomials. This result was conjectured by S. Kerov (according to P. Biane, see [Bia03]).

Theorem 6.3 (Kerov's conjecture). *For any integer $k \geq 1$, the polynomial K_k has non-negative coefficients.*

Our proof gives a (complicated) combinatorial interpretation of the coefficients and allows us to compute some of them.

6.1.4.1 High graded degree terms

Theorem 6.4. *Let j_1, \dots, j_t be non negative integers such that $\sum_i j_i = k - 1$. The coefficient of $\prod_i R_{j_i}$ in K_k is*

$$\frac{(k - 1)k(k + 1)}{24} |\text{Perm}(\mathbf{j})| \prod_i (j_i - 1), \tag{89}$$

where $\text{Perm}(\mathbf{j})$ is the set of sequences equal to \mathbf{j} up to a permutation ($|\text{Perm}(\mathbf{j})| = \frac{t!}{m_2! \dots m_{k-1}!}$ is the multinomial coefficient of the m_l 's, where m_l is the number of j_i equal to l).

This theorem gives an explicit formula for the term of graded degree $k - 1$ in K_k , which is the subdominant term for character values on a cycle. It has already been proved in two different ways by I.P. Goulden and A. Rattan in [GR07] and by P. Śniady in [Śni06a]. The proof in this article is a new one, which is a consequence of our general combinatorial interpretation.

6.1.4.2 Low degree terms

Theorem 6.5. *The coefficient of the linear monomial R_d in K_k is the number of cycles $\tau \in S(k)$ such that $\tau^{-1}(12 \dots k)$ has $d - 1$ cycles.*

Let k, j, l be positive integers, the coefficient of $R_j R_l$ in K_k is the number (respectively half the number is $j = l$) of pairs (τ, φ) which fulfill the following conditions :

- The first element τ is a permutation in $S(k)$ such that $|C(\tau)| = 2$. The second element φ is a bijection $|C(\tau)| \xrightarrow{\sim} \{1; 2\}$. So we count some permutations with numbered cycles.
- $\tau^{-1}\sigma$ has $j + l - 2$ cycles.
- Among these cycles, at least j have an element in commun with $\varphi^{-1}(1)$ and at least l with $\varphi^{-1}(2)$.

The first part of this theorem was proved by R. Stanley and P. Biane [Bia03] separately, the second is a new result. As in our general combinatorial interpretation, these coefficients can be computed by counting permutations in $S(k)$. So, when the support of the permutations is quite small, we can compute quickly character values from free cumulants.

6.1.5 A combinatorial formula for character values

The main tool in this article is the following formula, conjectured by R. Stanley in [Sta06] and proved by the author in [Fér08b] (please beware that the noations are a little different than in the original papers). As noticed in paragraph 6.1.1, if we have two sequences \mathbf{p} and \mathbf{q} of non-negative integers with only finitely many non-zeros terms, we consider the partition drawn on figure 6.1 :

$$\lambda(\mathbf{p}, \mathbf{q}) := \underbrace{\sum_{i \geq 1} q_i, \dots, \sum_{i \geq 1} q_i}_{p_1 \text{ times}}, \underbrace{\sum_{i \geq 2} q_i, \dots, \sum_{i \geq 2} q_i}_{p_2 \text{ times}}, \dots$$

With this notation, the $R_i(\lambda(\mathbf{p}, \mathbf{q}))$ are homogeneous polynomials of degree i in \mathbf{p} and \mathbf{q} .

Theorem 6.6. *Let \mathbf{p} and \mathbf{q} be two finite sequences, $\lambda(\mathbf{p}, \mathbf{q}) \vdash n$ the associated Young diagram and $\mu \vdash k$ ($k \leq n$). If $\sigma \in S(k)$ is a permutation of type μ , the character value is given by the formula :*

$$\Sigma_\mu(\lambda(\mathbf{p}, \mathbf{q})) = \sum_{\substack{\tau, \bar{\tau} \in S(k) \\ \tau \bar{\tau} = \sigma}} (-1)^{|C(\tau)|+r} N^{\tau, \bar{\tau}}(\mathbf{p}, \mathbf{q}), \quad (90)$$

where $N^{\tau, \bar{\tau}}$ is an homogeneous power series of degree $|C(\tau)|$ in \mathbf{p} and $|C(\bar{\tau})|$ in \mathbf{q} which will be defined in section 6.2.

This theorem gives a combinatorial interpretation of the coefficients of Σ_μ , expressed as a polynomial in variables \mathbf{p} and \mathbf{q} . It is natural to wonder if there exists such an expression for free cumulants. Since R_{l+1} is the term of graded degree $l+1$ of Σ_l (see [Bia98, Theorem 1.3]), we obtain the following formula (A. Rattan has also given a direct proof of this result in [Rat07b]) :

$$\begin{aligned} R_{l+1}(\lambda(\mathbf{p}, \mathbf{q})) &= \sum_{\substack{\tau, \bar{\tau} \in S(l) \\ \tau \bar{\tau} = (1 \dots l) \\ |C(\tau)| + |C(\bar{\tau})| = l+1}} (-1)^{|C(\tau)|+1} N^{\tau, \bar{\tau}}(\mathbf{p}, \mathbf{q}); \\ &= \sum_{\pi \in NC(l)} (-1)^{|\pi|+1} N^\pi(\mathbf{p}, \mathbf{q}). \end{aligned} \quad (91)$$

The second equality comes from the fact that factorizations $\tau, \bar{\tau}$ of the long cycle $(1 \dots l)$ such that $|C(\tau)| + |C(\bar{\tau})| = l+1$ are canonically in bijection with non-crossing partitions (see paragraph 6.1.3). Note that N^π is simply a short notation for $N^{\sigma_\pi, \sigma_\pi^{-1}(1 \dots l)}$.

From now on, we consider Σ_k and R_l as power series in two infinite sets of variables (\mathbf{p}, \mathbf{q}) and look at equality (88) in this algebra (equality as power series in \mathbf{p} and \mathbf{q} is equivalent to equality for all Young diagram λ , whose size is bigger than a given number). If we expand $K_k(R_2, \dots, R_{k+1})$, we obtain an algebraic sum of product of power series associated to minimal factorizations. In this article, we write each term of the right side of (90) as such a sum.

6.1.6 Generalized Kerov's polynomials

The theorems of paragraph 6.1.4 correspond to the case where μ has only one part. But, in fact, they have generalizations for any $\mu \vdash k$.

Firstly, there exist universal polynomials K_μ , called generalized Kerov's polynomials, such that :

$$\Sigma_\mu(\lambda) = K_\mu(R_2(\lambda), \dots, R_{k+1}(\lambda)). \quad (92)$$

$$\begin{aligned}
\text{Examples : } \Sigma_{2,2} &= R_3^2 - 4R_4 - 2R_2^2 - 2R_2; \\
\Sigma_{3,2} &= R_3 \cdot R_4 - 5R_2 \cdot R_3 - 6R_5 - 18R_3; \\
\Sigma_{2,2,2} &= R_3^3 - 12R_3 \cdot R_4 - 6R_3 \cdot R_2^2 + 58R_3 \cdot R_2 + 40R_5 + 80R_3.
\end{aligned}$$

Secondly, although these polynomials do not have non-negative coefficients, the following generalization of theorem 6.3 holds :

Theorem 6.7. *Let $\mu \vdash k$ and $\sigma \in S(k)$ a permutation of type μ .*

$$\Sigma'_\mu := \sum_{\substack{\tau, \bar{\tau} \in S(k) \\ \tau \bar{\tau} = \sigma \\ \langle \tau, \bar{\tau} \rangle \text{ trans.}}} (-1)^{|C(\tau)|+1} N^{\tau, \bar{\tau}}, \quad (93)$$

where $\langle \tau, \bar{\tau} \rangle$ trans. means that the subgroup $\langle \tau, \bar{\tau} \rangle$ of $S(k)$ generated by τ and $\bar{\tau}$ acts transitively on the set $[k]$. Then there exists a polynomial K'_μ with non-negative integer coefficients such that, as power series :

$$\Sigma'_\mu = K'_\mu(R_2, \dots, R_{k+1}). \quad (94)$$

$$\begin{aligned}
\text{Examples : } \Sigma'_{2,2} &= 4R_4 + 2R_2^2 + 2R_2; \\
\Sigma'_{3,2} &= 6R_2 \cdot R_3 + 6R_5 + 18R_3; \\
\Sigma'_{2,2,2} &= 64R_3 \cdot R_2 + 40R_5 + 80R_3.
\end{aligned}$$

Sections 6.2, 6.3 and 6.4 are devoted to the proof of this theorem.

The quantities Σ' are not only practical for the statement of this theorem, they also appear as disjoint cumulants [FŚ07, Proposition 22] for study of the asymptotics of character values in [Śni06b]. It is also easy to recover Σ from Σ' by looking, for each decomposition, at the set partition of $[k]$ in orbits under the action of $\langle \tau, \bar{\tau} \rangle$ (one has to be careful about the signs) :

$$\Sigma_\mu = \sum_{\Pi \text{ partition of } [l(\mu)]} \left(\prod_{\{i_1, \dots, i_l\} \text{ part of } \Pi} (-1)^{l-1} \Sigma'_{\mu_{i_1}, \dots, \mu_{i_l}} \right). \quad (95)$$

If we invert this formula with (usual) cumulants, then our positivity result on generalized Kerov's polynomials is exactly the one conjectured by A. Rattan and P. Śniady in [RŚ08].

6.1.6.1 Subdominant term for general μ .

We can also compute some particular coefficients in this general context :

For low degree terms, the first part of theorem 6.5 is still true (it has been proved in [RŠ08] in this general context) and the second is true with K'_μ instead of K_μ and with an additional condition in the second part : $\langle \tau, \tau^{-1}\sigma \rangle$ acts transitively on $[k]$.

The highest graded degree in K'_μ is $|\mu| + 2 - l(\mu)$. In the case $l(\mu) = 2$, we can explicitly compute the corresponding term.

Theorem 6.8. *Let $N(l_1, \dots, l_t; L)$ be the number of solutions of the equation $x_1 + \dots + x_t = L$, fulfilling the condition that, for each i , x_i is an integer between 0 and l_i . Then, the coefficient of a monomial $\prod_{i=1}^t R_{j_i}$ of graded degree $r + s$ in $K'_{r,s}$ is :*

$$\frac{r \cdot s}{t} |\text{Perm}(\mathbf{j})| N(j_1 - 2, \dots, j_t - 2; r - t). \quad (96)$$

This result gives the subdominant term for character values on any fixed permutation :

Corollary 6.9. *For any $\mu = (k_1, \dots, k_r) \vdash k$, one has :*

$$\begin{aligned} \Sigma_\mu = & \prod_{i=1}^r R_{k_i+1} + \\ & \sum_{i=1}^r \left[\left(\prod_{h \neq i} R_h \right) \left(\sum_{|\mathbf{j}|=i-1} \frac{(k-1)k(k+1)}{24} |\text{Perm}(\mathbf{j})| \prod_i^{l(\mathbf{j})} (j_i - 1) R_{j_i} \right) \right] \\ + & \sum_{1 \leq i_1 < i_2 \leq r} \left[\left(\prod_{h \neq i_1, i_2} R_h \right) \left(\sum_{|\mathbf{j}|=i_1+i_2} \frac{i_1 \cdot i_2}{l(\mathbf{j})} |\text{Perm}(\mathbf{j})| N(j_1 - 2, \dots, j_t - 2; i_1 - t) \prod_{i=1}^{l(\mathbf{j})} R_{j_i} \right) \right] \\ & + \text{lower graded degree terms.} \end{aligned}$$

Proof. In equation (95), the only summands which contain terms of degree $|\mu| + r - 2$ are the one indexed by the partition of $[l(\mu)]$ in singletons and those indexed by partitions in one pair and singletons. \square

6.1.7 Organization of the article

In section 6.2, we will associate a map to each pair of permutations. This will help us to define the associated power series N . In section 6.3, for any map M , we write $N(M)$ as an algebraic sum of power series associated to minimal factorizations. The section 6.4 is the end of the proof of theorem 6.7. Then, in section 6.5, we will compute some particular coefficients (proofs of theorems 6.4, 6.5 and 6.8).

6.2 Maps and polynomials

In this section, we define the power series $N^{\tau, \bar{\tau}}$ as the composition of three functions :

$$S(k) \times S(k) \xrightarrow{\S 6.2.1} \text{bicolored labeled map} \xrightarrow{\text{Forget}} \text{bicolored graph} \xrightarrow{\S 6.2.2} \mathbb{C}[[\mathbf{p}, \mathbf{q}]]$$

6.2.1 From permutations to maps

Let us give some definitions about graphs and maps.

Définition 6.2 (graphs).

- A graph is given by :
 - a finite set of vertices V ;
 - a set of half-edges H with a map ext from H to V (the image of an half-edge is called its extremity) ;
 - a partition of H into pairs (called edges, whose set is denoted E) and singletons (the external half-edges).
- A bicolored graph is a graph with a partition of V in two sets (the set of white vertices V_w and the set of black vertices V_b) such that, for each edge, among the extremities of its two half-edges, one is black and one is white.
- A labeled graph is a graph with a map ι from E in \mathbb{N}^* . Moreover, we say that it is well labeled if ι is a bijection of image $[[E]]$.
- An oriented edge e is an edge e with an order of its two half-edges.
- An oriented loop is a sequence of oriented edge e_1, \dots, e_l such that :
 - For each i , the extremity v_i of the first half-edge of e_{i+1} is the same as the extremity of the second of e_i (with the convention $e_{l+1} = e_1$) ;
 - All the v_i 's and the e_i 's are different (an edge does not appear twice, even with different orientations).

We identify sequences that differ only by a cyclic permutation of their oriented edges.

- The free abelian group on graphs has a natural ring structure : the product of two graphs is by definition their disjoint union.

Définition 6.3 (Maps).

- A map is a graph supplied with, for each vertex v , a cyclic order on the set of all half-edges (including the external ones) of extremity v (*i.e.* $ext^{-1}(v)$).
- Consider an half-edge h of a map M . Thanks to the map structure, there is a cyclic order on the set of half-edges having the same extremity as h . We call successor of h the element just after h in this order.
- Since a map is a graph with additional informations, we have the notion of bicolored and/or (well-)labeled map.
- A face of a map is a sequence of oriented edge e_1, \dots, e_k such that, for each i , the first half-edge of e_{i+1} ($e_{l+1} = e_1$) is the successor of the second half-edge of e_i . As for loops,

we identify the sequences which differ by cyclic permutations of their oriented edges. Then each oriented edge is in exactly one face.

- If F is a face of a map is labeled and bicolored, we denote by $E(F)$ the set of edges appearing in F with the white to black orientation. The word associated to a face is the word $w(F)$ of the labels of the elements of $E(F)$ (it is defined up to a cyclic permutation).
- A face, which is also a loop (all vertices and edges of the face are distinct) and which does not contain an external half-edge, is called a polygon.

Remark. A map, whose underlying graph is a tree, is a planar tree. It has exactly one face.

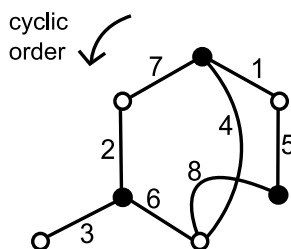

FIG. 6.2 – Example of a bicolored labeled map, with exactly one face whose associated word is 12345678

Map associated with a pair of permutations The following construction is classical (it generalizes the work of I.P. Goulden and D.M. Jackson in [GJ92]) but we recall it for completeness.

Définition 6.4. To a well-labeled bicolored map M with k edges and no external half-edges, we associate the pair of permutations $(\tau, \bar{\tau}) \in S(k)^2$ defined by : if i is an integer in $[k]$, e the edge of M with label i and h its half-edge with a white (resp. black) extremity, then $\tau(i)$ (resp. $\bar{\tau}(i)$) is the label of the edge containing the successor of h .

It is easy to see that this defines a bijection between well-labeled bicolored maps and pairs of permutations in $S(k)$. Its inverse associates to a pair of permutations $(\tau, \bar{\tau})$ the following bicolored labeled map $M^{\tau, \bar{\tau}}$: the set of white vertices is $C(\tau)$, the one of black vertices $C(\bar{\tau})$, the set of half-edges $\{1^w, 1^b, \dots, k^w, k^b\}$ is partitioned in edges $\{i^w, i^b\}$ and the cycle (i_1, \dots, i_l) of τ (resp. (j_1, \dots, j_l) of $\bar{\tau}$) is the extremity of the half-edges i_1^w, \dots, i_l^w (resp. j_1^b, \dots, j_l^b) in this cyclic order.

The following property follows straight forward from the definition :

Proposition 6.10. *The words associated to the faces of $M^{\tau, \bar{\tau}}$ are exactly the cycles of the product $\tau\bar{\tau}$.*

Example. The map drawn on figure 6.2 is associated to the following pair of permutations : $((15)(27)(3)(486), (174)(236)(58))$ of product (12345678) . The word associated to its unique face is 12345678 as predicted by proposition 6.10.

Note that the connected components of $M^{\tau, \bar{\tau}}$ are in bijection with the orbits of $[k]$ under the action of $\langle \tau, \bar{\tau} \rangle$. So, a factorization is transitive if and only if its map is connected. In particular, maps of minimal factorizations of the full cycle $(12 \dots k)$ are exactly the connected maps with $k + 1$ vertices and k edges, that is to say the planar trees.

6.2.2 From graphs to polynomials

Définition 6.5. Let G be a bicolored graph and V its set of vertices, disjoint union of V_b and V_w . An evaluation $\psi : V \rightarrow \mathbb{N}^*$ is said admissible if, for any edge between a white vertex w and a black one b , it fulfills $\psi(b) \geq \psi(w)$. The power series $N(G)$ in indeterminates \mathbf{p} and \mathbf{q} is defined by the formula :

$$N(G) = \sum_{\substack{\psi: V \rightarrow \mathbb{N} \\ \text{admissible}}} \prod_{w \in V_w} p_{\psi(w)} \prod_{b \in V_b} q_{\psi(b)}. \quad (97)$$

Note that N is extended to the ring \mathbb{A}_{bg} of bicolored graphs by \mathbb{Z} -linearity. It is in fact a morphism of rings (the power series associated to a disjoint union of graphs is simply the product of the power series associated to these graphs).

If τ and $\bar{\tau}$ are two permutations in $S(k)$, we put :

$$N^{\tau, \bar{\tau}} := N(M^{\tau, \bar{\tau}}).$$

This definition is the one that appears in theorem 6.6. The main step of our proof of Kerov's conjecture is to write the power series associated to any pair of permutations as an algebraic sum of power series associated to forests (*i.e.* products of power series associated to minimal factorizations).

Let G be a bicolored graph and L an oriented loop of G . We denote by $E(L)$ the set of edges which appear in the sequence L oriented from their white extremity to their black one. Let us define the following element of the \mathbb{Z} -module \mathbb{A}_{bg} :

$$T_L(G) = \sum_{\substack{E' \subset E(L) \\ E' \neq \emptyset}} (-1)^{|E'|-1} G \setminus E', \quad (98)$$

where $G \setminus E'$ denotes the graph obtained by taking G and erasing its edges belonging to E' (it is a subgraph of G with the same set of vertices). These elementary transformations are drawn on figure 6.3, where we have only drawn vertices and edges belonging to the loop L (so these schemes can be understood as local transformations).

An example of such a transformation is drawn in figure 6.4. G is the map of figure 6.2 (we forget the labels and the map structure) and L the loop 7, 2, 6, 4.

We have the following conservation property :

Proposition 6.11. *If G is a bicolored graph and L an oriented loop of G , then*

$$N(T_L(G)) = N(G). \quad (99)$$

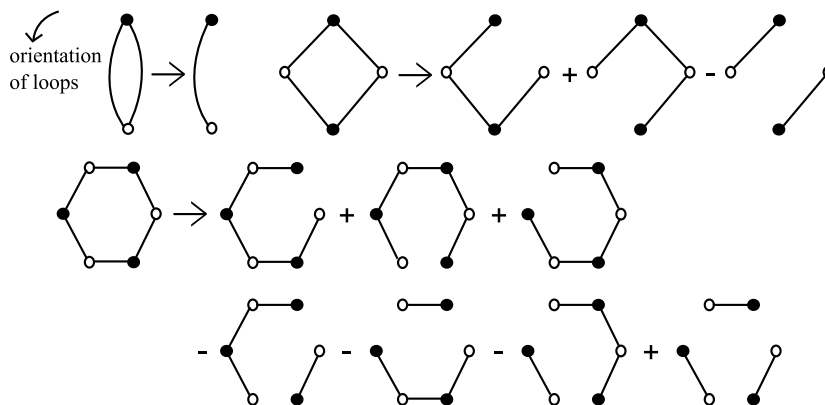

FIG. 6.3 – Illustration of definition of transformation T_L

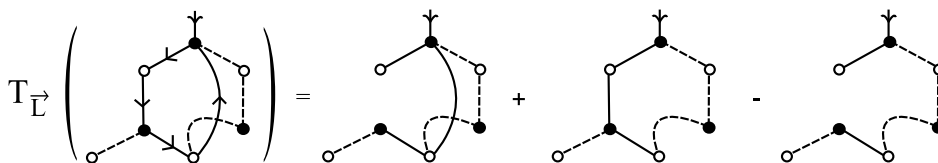

FIG. 6.4 – Example of an elementary transformation.

Proof. Let G be a bicolored graph and V_w, V_b, E as in definition 6.2. We write the series $N(G)$ as the following sum :

$$\begin{aligned}
 N(G) &= \sum_{\psi_w: V_w \rightarrow \mathbb{N}^*} \left[\sum_{\substack{\psi: V \rightarrow \mathbb{N}^* \text{ admissible} \\ \psi|_{V_w} = \psi_w}} \prod_{w \in V_w} p_{\psi(w)} \prod_{b \in V_b} q_{\psi(b)} \right]; \\
 &= \sum_{\psi_w: V_w \rightarrow \mathbb{N}^*} N_{\psi_w}(G).
 \end{aligned} \tag{100}$$

Since all the graphs in the equality (99) have the same set of vertices V_w , it is enough to prove that, for every $\psi_w : V_w \rightarrow \mathbb{N}^*$, we have :

$$N_{\psi_w}(T_L(G)) = N_{\psi_w}(G). \tag{101}$$

Let us fix a partial evaluation $\psi_w : V_w \rightarrow \mathbb{N}^*$. If we choose a numbering w_1, \dots, w_l (with respect to the loop order) of the white vertices of L , then there exists an index i such that $\psi_w(w_{i+1}) \geq \psi_w(w_i)$ (with the convention $w_{l+1} = w_1$). Denote by e the edge just after w_i in the loop L . It is an erasable edge. So we have a bijection :

$$\begin{aligned}
 \{E' \subset E(L), e \notin E'\} &\xrightarrow{\sim} \{E'' \subset E(L), e \in E''\} \\
 E' &\mapsto E'' = E' \cup \{e\}.
 \end{aligned}$$

But, this bijection has the following property :

$$N_{\psi_w}(G \setminus E') = N_{\psi_w}(G \setminus (E' \cup \{e\})).$$

Indeed the admissible evaluations whose restrictions to white vertices is ψ_w are the same for the two graphs $G \setminus E'$ and $G \setminus (E' \cup \{e\})$. The only thing to prove is that, if such a ψ is admissible for $G \setminus (E' \cup \{e\})$, it fulfills also : $\psi(b_e) \geq \psi(w_i)$, where b_e is the black extremity of e . This is true because

$$\psi(b_e) \geq \psi(w_{i+1}) = \psi_w(w_{i+1}) \geq \psi_w(w_i) = \psi(w_i).$$

To conclude the proof, note that cardinals of E' and $E' \cup \{e\}$ have different parity so they appear with different signs in $G - T_L(G)$. Their contributions to (101) cancel each other and the proof is over. \square

Recall that N is a morphism of rings, so $(\mathbb{A}_{bg})_{/KerN}$ is a ring.

Corollary 6.12. *The ring $(\mathbb{A}_{bg})_{/KerN}$ is generated by trees.*

Proof. Just iterate the proposition by choosing any oriented loop until there is no loop left (if a graph is not a disjoint union of trees, there is always one). \square

However, forests are not linearly independent in $(\mathbb{A}_{bg})_{/KerN}$.

6.3 Map decomposition

By iterating proposition 6.11 until there are only forests left, given a graph G , we obtain an algebraic sum of forests whose associated power series is $N(G)$. But there are many possible choices of oriented loops and they can give different sums of forests. In this section, we explain, how, by restricting the choices, we choose a particular one, which depends on the map structure and the labeling.

6.3.1 Elementary decomposition

To do coherent choices, it is convenient to add an external half-edge to our map. So, in this paragraph, we deal with bicolored maps with exactly one external half-edge h . They generate a free \mathbb{Z} -module denoted $\mathbb{A}_{bm,1}$.

If M is such a map, let \star be the extremity of its external half-edge. An (oriented) loop L is said admissible if :

- The vertex \star is a vertex of the loop, that is to say that \star is the extremity of the second half-edge $h_{i,2}$ of e_i and of the first half-edge $h_{i+1,1}$ of e_{i+1} for some i ;
- The cyclic order at \star restricted to the set $\{h, h_{i,2}, h_{i+1,1}\}$ corresponds to the cyclic order $(h, h_{i+1,1}, h_{i,2})$.

For example, the oriented loop L of figure 6.4 is admissible. If L satisfies the first condition, exactly one among the oriented loops L and L' is admissible (where L' is L with the opposite orientation).

Definition-Theorem 6.13. *There exists a unique linear operator*

$$D_1 : \mathbb{A}_{bm,1} \rightarrow \mathbb{A}_{bm,1}$$

such that :

- The image of a given map M lives in the vector space spanned by its submaps with the same set of vertices ;
- If L is an admissible loop of M , then

$$D_1(M) = D_1(T_L(M)). \quad (102)$$

Note that this equality is meant as an equality between submaps of M , not only as isomorphic maps ;

- If there is no admissible loops in M , then $D_1(M) = M$.

Proof. If M is a bicolored map, all graphs appearing in $T_L(M)$ have strictly less edges than M . So the uniqueness of D_1 is obvious.

The existence of D_1 will be proved by induction. Denote, for every N , $\mathbb{A}_{bm,1}^N$ the submodule of $\mathbb{A}_{bm,1}$ generated by graphs with at most N edges. We will prove that there exists, for every N , an operator $D_1^N : \mathbb{A}_{bm,1}^N \rightarrow \mathbb{A}_{bm,1}^N$, extending D_1^{N-1} if $N \geq 1$, and satisfying the conditions asked for D_1 . The case $N = 0$ is very easy because $\mathbb{A}_{bm,1}^0$ is generated by graphs without admissible loops, so $D_1^0 = Id$. If our statement is proved for any N , it implies the existence of D_1 : take the inductive limit of the D_1^N .

Let $N \geq 1$ and suppose that D_1^{N-1} has been built. To prove the existence of D_1^N , we have to prove that, if M has admissible loops, then $D_1^{N-1}(T_L(M))$ does not depend on the chosen admissible loop L . To do this, let us denote by M_\star the submap of M containing exactly all the edges of M which belong to some admissible loop of M . The maps M and M_\star have exactly the same admissible loops. We define $H = |E(M_\star)| - |V(M_\star)| + 1$ (which might be understood as the number of independent loops in M_\star).

If $H = 0, 1$, the map M has at most one admissible loop, so there is nothing to prove :

- If M has exactly no admissible loop, then $D_1^N(M) = M$.
- If M has exactly one admissible loop L , then $D_1^N(M) = T_L(M)$.

If $H = 2$ and if there is a vertex of valence 4 in M_\star different from \star , then there is at most one admissible loop. If $H=2$ and if \star is a vertex of valence 4, then there are two admissible loops L_1 and L_2 without any edges in commun, so the transformation with respect to these loops commute, so

$$D^{N-1}(T_{L_1}(M)) = T_{L_2}(T_{L_1}(M)) = T_{L_1}(T_{L_2}(M)) = D^{N-1}(T_{L_2}(M)).$$

If $H = 2$ and if \star and an other vertex v have valence 3, there are three admissible loops. In M_\star , there are three different paths c_0, c_1, c_2 going (without any repetition of vertices or edges) from \star to v . We number them such that, if h_i is the first half-edge of the path c_i , the cyclic order at \star is (h, h_0, h_1, h_2) . Let us denote by E_i ($0 \leq i \leq 2$) (resp. by E_i') the set of edges appearing in c_i oriented from their black vertex to their white one (resp. from their white vertex to their black one). If $I = \{i_1, \dots, i_l\} \subset \{0, 1, 2, \bar{0}, \bar{1}, \bar{2}\}$, we consider the following element of $\mathbb{A}_{bg,1}$:

$$M_I = \sum_{\emptyset \neq E'_1 \subset E_{i_1}, \dots, \emptyset \neq E'_l \subset E_{i_l}} (-1)^{|E'_1|-1} \dots (-1)^{|E'_l|-1} M \setminus (E'_1 \cup \dots \cup E'_l).$$

Let $L_1 = c_0 \cdot \overline{c_1}$, $L_2 = c_1 \cdot \overline{c_2}$ and $L_3 = c_0 \cdot \overline{c_2}$ be the three admissible loops of M . Their respective sets of erasable edges are $E_0 \cup E_1$, $E_0 \cup E_2$ and $E_1 \cup E_2$. So we have (the figure 6.5 shows this computation on an example, where all sets E_i are of cardinal 1) :

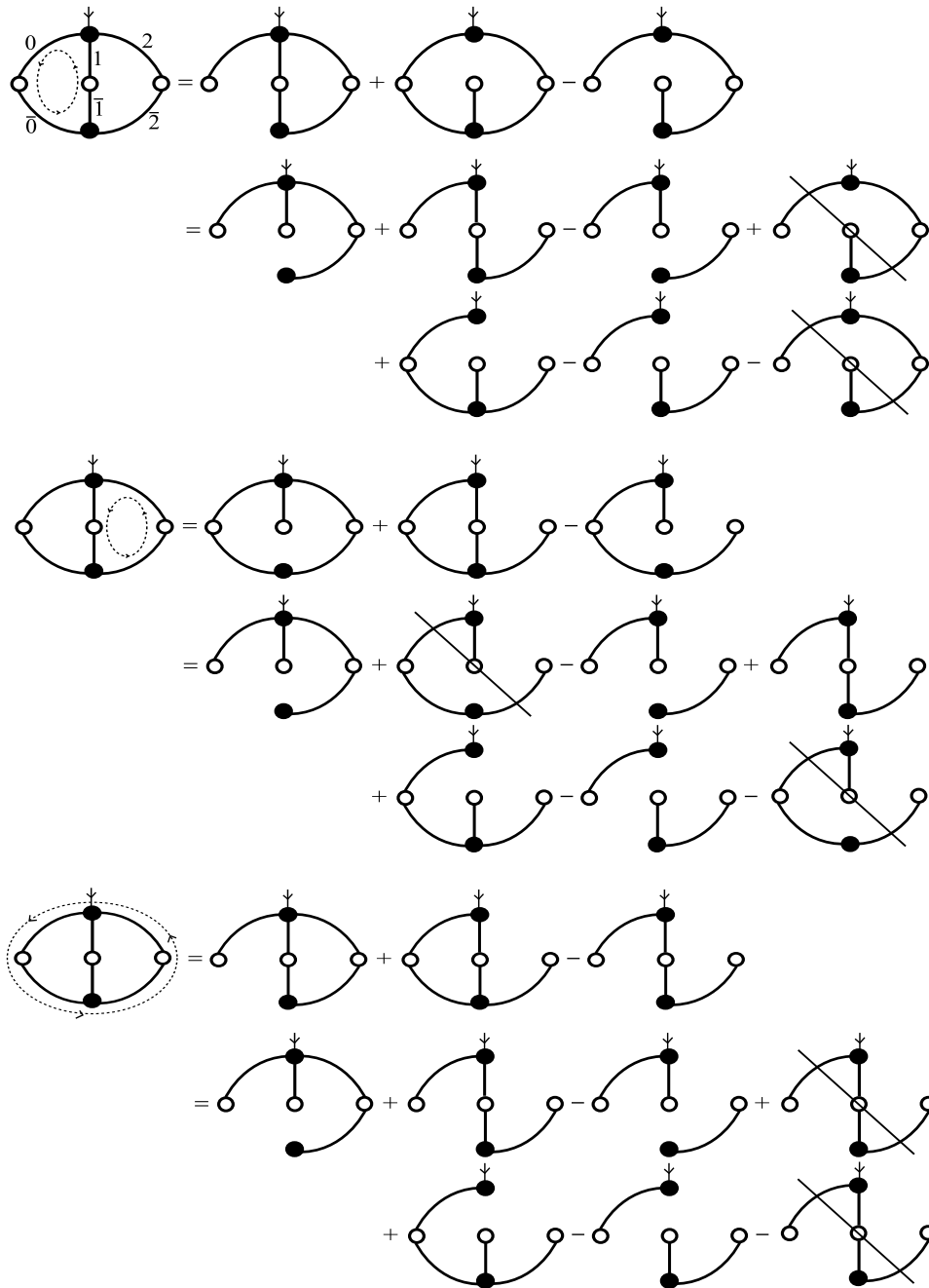

FIG. 6.5 – One particular case of definition-theorem 6.13

$$\begin{aligned}
T_{L_1}(M) &= \sum_{\substack{E' \subset E_1 \\ E' \neq \emptyset}} (-1)^{|E'|-1} M \setminus E' + \sum_{\substack{E' \subset E_0 \\ E' \neq \emptyset}} (-1)^{|E'|-1} M \setminus E' \\
&+ \sum_{\substack{E' \subset (E_1 \cup E_0) \\ (E' \cap E_1) \neq \emptyset, (E' \cap E_0) \neq \emptyset}} (-1)^{|E'|-1} M \setminus E'; \\
&= M_{\bar{0}} + M_1 - M_{1, \bar{0}}.
\end{aligned}$$

For each graph appearing in $M_{\bar{0}}$, M_1 there is only one admissible loop so D_1^{N-1} is just given by the corresponding elementary transform :

$$\begin{aligned}
D_1^{N-1}(T_{L_1}(M)) &= M_{\bar{0}, \bar{1}} + M_{2, \bar{0}} - M_{2, \bar{0}, \bar{1}} + M_{1, \bar{0}} + M_{1, 2} - M_{1, 2, \bar{0}} - M_{1, \bar{0}}, \\
&= M_{\bar{0}, \bar{1}} + M_{2, \bar{0}} - M_{2, \bar{0}, \bar{1}} + M_{1, 2} - M_{1, 2, \bar{0}}.
\end{aligned}$$

For the other admissible loops, we obtain :

$$\begin{aligned}
D_1^{N-1}(T_{L_2}(M)) &= D_1^{N-1}(M_{\bar{1}} + M_2 - M_{2, \bar{1}}), \\
&= M_{\bar{0}, \bar{1}} + M_{2, \bar{1}} - M_{2, \bar{0}, \bar{1}} + M_{2, \bar{0}} + M_{1, 2} - M_{1, 2, \bar{0}} - M_{2, \bar{1}}, \\
&= M_{\bar{0}, \bar{1}} - M_{2, \bar{0}, \bar{1}} + M_{2, \bar{0}} + M_{1, 2} - M_{1, 2, \bar{0}}; \\
D_1^{N-1}(T_{L_3}(M)) &= D_1^{N-1}(M_{\bar{0}} + M_2 - M_{2, \bar{0}}), \\
&= M_{\bar{0}, \bar{1}} + M_{2, \bar{0}} - M_{2, \bar{0}, \bar{1}} + M_{2, \bar{0}} + M_{1, 2} - M_{1, 2, \bar{0}} - M_{2, \bar{0}}, \\
&= M_{\bar{0}, \bar{1}} - M_{2, \bar{0}, \bar{1}} + M_{2, \bar{0}} + M_{1, 2} - M_{1, 2, \bar{0}}.
\end{aligned}$$

If $H = 2$ and if there are two vertices v and v' of valence 3 distinct from \star , the proof is similar. We use the same notations, except that :

- The paths c_0 , c_1 and c_2 go from v to v' .
- The vertex \star is on c_0 . It does not matter to exchange c_1 and c_2 .
- If the half-edge just before (resp. just after) \star in c_0 is denoted by h_1 (resp. h_2), the cyclic order at \star induces the order (h_1, h, h_2) .

In this case, there are only two admissible loops L_1 and L_3 in M and a little computation proves the theorem :

$$\begin{aligned}
D_1^{N-1}(T_{L_1}(M)) &= D_1^{N-1}(M_{\bar{0}} + M_1 - M_{1, \bar{0}}), \\
&= M_{\bar{0}} + M_{1, \bar{0}} + M_{1, 2} - M_{1, 2, \bar{0}} - M_{1, \bar{0}}, \\
&= M_{\bar{0}} + M_{1, 2} - M_{1, 2, \bar{0}}; \\
D_1^{N-1}(T_{L_3}(M)) &= D_1^{N-1}(M_{\bar{0}} + M_2 - M_{2, \bar{0}}), \\
&= M_{\bar{0}} + M_{2, \bar{0}} + M_{1, 2} - M_{1, 2, \bar{0}} - M_{2, \bar{0}}, \\
&= M_{\bar{0}} + M_{1, 2} - M_{1, 2, \bar{0}}.
\end{aligned}$$

The proof is over in the case $H = 2$.

The case $H \geq 3$ needs the two following lemmas :

Lemma 6.14. *Let L be an admissible loop of M and e an edge of $M \setminus L$. Then,*

$$D_1^{N-1}(T_L(M)) = D_1^{N-1}(D_1^{N-1}(M \setminus \{e\}) \cup \{e\}),$$

where, for a submap $M' \subset M$ with the same set of vertices which does not contain e , $M' \cup \{e\}$ the map obtained by adding the edge e to M' .

Proof. To compute the left side of the equation, we choose, for every graph in $T_L(M)$, one of its admissible loop, apply the associated transformation and iterate this. If, whenever it is possible, we choose an admissible loop that does not contain e , the first choices done are also choices of admissible loops for the map $M \setminus \{e\}$. After the associated transformations, we obtain $D_1^{N-1}(M \setminus \{e\}) \cup \{e\}$ and the lemma follows. \square

Lemma 6.15. *If $H \geq 3$ and if L_1 and L_2 are two admissible loops with $L_1 \cup L_2 = M$, then there exists a third one L such that $L \cup L_1 \neq M$ and $L \cup L_2 \neq M$.*

Proof. We choose a numbering of the oriented edges of the loops so that the first half-edge of e_1 has \star for extremity. We suppose (eventually by exchanging L_1 and L_2) that the first half-edge of L_1 is between h_0 and the first half-edge of L_2 in the cyclic order of \star . As $L_1 \cup L_2 = M$, the loops L_1 and L_2 have an other vertex in commun than \star (otherwise, M is a wedge of two cycles and $H = 2$). Let v be the first vertex of L_1 which is also in L_2 but such that the paths from \star to v given by the beginnings of L_1 and L_2 are different. Let us consider the sequence L equal to the concatenation of the beginning of L_1 (from \star to v) and the end of L_2 (from v to \star). With this definition :

- All vertices and edges appearing in L are distinct. Moreover, L is an admissible loop ;
- The edge before v in L_2 belongs neither to L_1 nor to L ;
- As $H > 2$, the ends of L_1 and L_2 (from v to \star) are different. So there is an edge in the end of L_1 which belongs neither to L_2 nor to L . \square

Lemma 6.14 implies : if L_1 and L_2 are admissible loops such that $L_1 \cup L_2 \neq M$, we have :

$$D_1(T_{L_1}(M)) = D_1(T_{L_2}(M)).$$

Together with lemma 6.15, this ends the proof of the theorem. \square

Remark (useful in paragraph 6.4.2). The definition of this operator does not really need the maps to be bicolored. It is enough to suppose that each edge has a privileged orientation. In this context, the erasable edges of a oriented loop are the one which appear in the loop in their privileged orientation and operator T_L has a sense. A bicolored map can be seen this way if we choose as orientation of each edge the one from the white vertex to the black one.

6.3.2 Complete decomposition

It is immediate from the definition that every map M' appearing with a non-zero coefficient in $D_1(M)$ has no admissible loops. Thus they are of the following form (drawn on figure 6.6) :

The vertex \star is the extremity of half-edges $h_i (0 \leq i \leq l)$, including the external one h_0 , numbered with respect to the cyclic order. For $i \geq 1$, h_i belongs to an edge e_i , whose other extremity is v_i . Each v_i is in a different connected component M_i (called leg) of $M \setminus \{h_1, \dots, h_l\}$. Note that we have only erased the half-edge h_i and not the whole edge e_i so that each M_i keeps an external half-edge.

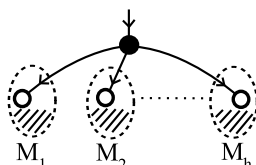

FIG. 6.6 – General form of the connected component containing \star of a map appearing in $D_1(M)$.

If we have a family of submaps $M'_i = M_i \setminus \{E'_i\}$ of the M_i , it will be interesting to consider the map $\phi_M(M'_1, \dots, M'_l) = M \setminus \bigcup \{E'_i\}$ obtained by replacing in M each M_i by M'_i .

The outcome of operator D_1 is an algebraic sum of maps, which are much more complicated than planar forests. So, in order to write $N(M)$ as an algebraic sum of series associated to minimal factorizations, we have to iterate such operations.

We want to define decompositions of maps associated to pairs of permutations, so of well-labeled bicolored maps without external edges. But it is convenient to work on a bigger module : the ring $\mathbb{A}_{blm, \leq 1}$ of bicolored labeled maps with at most one external half-edge per connected component.

Definition-Proposition 6.16. *There exists a unique linear operator*

$$D : \mathbb{A}_{blm, \leq 1} \rightarrow \mathbb{A}_{blm, \leq 1}$$

such that :

1. If M has only one vertex, then $D(M) = M$;
2. If M has more than one connected components $M = \prod M_i$, then one has $D(M) = \prod D(M_i)$;
3. If M has only one connected component and no external half-edge, consider its edge e of smallest label. Let h be the half-edge of e of black extremity. We denote by \overline{M} the map obtained by adding one external half-edge between h and its successor. Then $D(M) = D(\overline{M})$;
4. If M has only one connected component with one half-edge but no admissible loops, we use the notations of the previous paragraph. As the M_i are connected maps with an external half-edge, we can compute $D(M_i)$ (third or fifth case). Then $D(M)$ is given by the formula :

$$D(M) = \phi_M(D(M_1), \dots, D(M_l)),$$

where ϕ_M is extended by multilinearity to algebraic sums of submaps of the M_i 's.

5. Else, $D(M) = D(D_1(M))$.

Existence and uniqueness of D are obvious. The image of a map M by D is in the subspace generated by its submaps with the same set of vertices, no isolated vertices and no loops, i.e. its covering forests without trivial trees. Note also that forests are fixed points for D (immediate induction).

Example. We will compute $D(M)$ where M is the map of the figure 6.7 (without the external half-edge).

The map M belongs to the third kind, so we have to add an external half-edge as on the

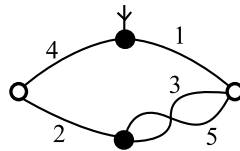

FIG. 6.7 – Map \overline{M} .

figure. Now, \overline{M} is a map of the fifth type and we have to compute $D_1(\overline{M})$: this is very easy because the two transformations associated with admissible loops lead to the same sum of submaps which do not contain any admissible loop.

$$D_1(M) = M \setminus \{1\} + M \setminus \{2\} - M \setminus \{1, 2\};$$

$$\text{So } D(M) = D(M \setminus \{1\}) + D(M \setminus \{2\}) - D(M \setminus \{1, 2\}).$$

The map $M \setminus \{1\}$ is a map of the fourth type with only one leg M_1 , which is drawn at figure 6.8.

This map M_1 is again of the fourth type (with one leg : the map M_2 of the figure 6.8) so

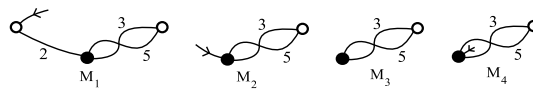

FIG. 6.8 – Maps involved in the computation of the example.

we have to compute $D(M_2)$, which is simply $D_1(M_2) = M_2 \setminus \{5\}$. This implies immediately that $D(M_1) = M_1 \setminus \{5\}$ and :

$$D(M \setminus \{1\}) = M \setminus \{1, 5\}.$$

$$\text{Similarly, } D(M \setminus \{2\}) = M \setminus \{2, 3\}.$$

Now we look at the map $M \setminus \{1, 2\}$. It has two connected component (we have to apply rule 2) : one is a tree and has a trivial image by D , the other one M_3 has no external half-edge. We have to add one external half-edge to M_3 with the third rule and obtain M_4 . Now, it is

clear that $D_1(M_4) = M_4 \setminus \{3\}$, so one has $D(M \setminus \{1, 2\}) = M \setminus \{1, 2, 3\}$.

Finally

$$D(M) = M \setminus \{1, 5\} + M \setminus \{2, 3\} - M \setminus \{1, 2, 3\}.$$

As we can see on the example, when we replace M_i by its image by several elementary transformations in M , we obtain the image of M by the same transformations. So, by an immediate induction, the operator D consists in applying to M an elementary transformation T_L (with restricted choices), then one to each map of the result which is not a forest, *etc.* until there are only forests left. An immediate consequence is the D -invariance of N .

Remark. Note that transformations indexed by loops which are in different connected components and/or in different legs of the map (fourth case) commute.

6.3.3 Signs

In this paragraph, we study the sign of the coefficients in the expression $D(M)$. This is central in the proof of theorem 6.7 because we will show that the coefficients of K'_μ can be written as a sum of coefficients of $D(M)$, for some particular maps M .

Proposition 6.17. *Let $M' \subset M$ two maps with the same set of vertices and respectively $t_{M'}$ and t_M connected components. The sign of the coefficient of M' in $(-1)^{t_M} D(M)$ is $(-1)^{t_{M'}}$.*

Proof. Due to the inductive definition of D using D_1 , it is enough to prove the result for operator D_1 in the case where M is a connected ($t_M = 1$) bicolored map with one external half-edge. We proceed by induction over the number of edges in $M \setminus M'$. If $M' = M$, the result is obvious. Note that if M' has a non-zero coefficient in $D_1(M)$, we have necessarily $M \setminus M' = \{e_1, \dots, e_l\}$ where each e_i belongs at least to one admissible loop.

First case : There exists an edge $e \in M \setminus M'$ such that $M \setminus \{e\}$ has at least one admissible loop. Let us define $M_1 = M \setminus \{e\}$ and apply the lemma 6.14 : $D_1(M) = D_1(D_1(M_1) \cup \{e\})$. The submaps M'' of M_1 containing M' can be divided in two classes :

- Either $M'' \cup \{e\}$ has the same number t of connected components as M'' . By induction hypothesis, the sign of the coefficient of $M'' \cup \{e\}$ in $D_1(M_1) \cup \{e\}$ is $(-1)^{t-1}$;
- Or $M'' \cup \{e\}$ has strictly less connected components than M'' . In this case $\{e\}$ does not belong to any loops of $M'' \cup \{e\}$, so every graph appearing in $D_1(M'' \cup \{e\})$ does contain $\{e\}$. In particular, the coefficient of M' in $D_1(M'' \cup \{e\})$ is zero.

Finally, the coefficient of M' in $D_1(M)$ is the same as in the sum of $D_1(M'' \cup \{e\})$ for M'' of the first class. So the result comes from the induction hypothesis applied to $M' \subset M'' \cup \{e\}$ (which can be done because $M'' \cup \{e\}$ has strictly less edges than M).

Second case : Else, up to a new numbering of edges of $M \setminus M'$, the map M' has l connected components M'_1, \dots, M'_l and, for each i , the two extremities of e_i belong to M'_i and M'_{i+1} (convention : $M'_{l+1} = M'_1$).

Choose any admissible loop L , it contains all the edges e_i . Indeed, if we look at a map of the kind $M'' = M \setminus E'$, with $E' \subsetneq \{e_1, \dots, e_l\}$, all edges of $\{e_1, \dots, e_l\} \setminus E'$ do not belong

to any loop of M'' and are never erased in the computation of $D_1(M)$. So the only term in $T_L(M)$ which contribute to the coefficient of M' is $(-1)^{l-1}M'$. \square

6.4 Decompositions and cumulants

In section 6.3, we have built an operator D on bicolored labeled maps which leaves N invariant and takes value in the ring spanned by forests. If we replace $N^{\tau, \bar{\tau}}$ by $N(D(M^{\tau, \bar{\tau}}))$ in the right hand side of equation (93), we obtain a decomposition of Σ'_μ as an algebraic sum of products of power series associated to minimal factorizations. In order to have something that looks like (94), we regroup some terms and make free cumulants appear through formula (91). To do this, it will be useful to encode these associations of terms into combinatorial objects that we will call cumulant maps.

6.4.1 Cumulant maps

Définition 6.6. A cumulant map \mathcal{M} of size k is a triple $(M_{\mathcal{M}}, \mathbf{F}, \iota)$ where $M_{\mathcal{M}}$ is a bicolored map with $|E| - |V| = k$, $\mathbf{F} = (F_1, \dots, F_t)$ is a family of faces of $M_{\mathcal{M}}$ such that

- The faces F_1, \dots, F_t are polygons (see definition 6.3)
- Every vertex of $M_{\mathcal{M}}$ belongs to exactly one face among F_1, \dots, F_t ;

and ι is a function from $E \setminus \bigcup_i (E(F_i))$ (the set $E(F)$ was introduced in definition 6.3) to \mathbb{N}^* (see figure 6.9 for an example). As in the case of classical maps, if ι is a bijection of image $[k]$, the cumulant map is said well-labeled.

By definition, the number of connected components of \mathcal{M} is the one of $M_{\mathcal{M}}$ and its resultant $\sigma_{\mathcal{M}}$ is the product of the cycles associated to the faces of $M_{\mathcal{M}}$ different from F_1, \dots, F_t .

Non-crossing partitions as compressions of a polygon Consider a polygon with $2j$ vertices, alternatively black and white. We choose an orientation, begin at a black vertex and label the edges $1', 1, 2', 2, \dots, j', j$. Given a non-crossing partition $\pi \in NC(j)$, we glue, for each i , the edge i with the edge $\sigma_\pi(i)'$ (σ_π is the permutation of $[Id_j; (1 \dots j)]$ canonically associated to π by proposition 6.1) so that their black extremities are glued together and also their white ones. In each of these gluings we only keep the label without $'$. The result is the labeled bicolored planar tree associated to the pair $(\sigma_\pi, \sigma_\pi^{-1}(1 \dots j))$.

This construction defines a bijection between $NC(j)$ and the different ways to compress a polygon with $2j$ vertices (with labeled edges) in a bicolored labeled planar tree with j edges. So we reformulate (91) :

$$R_{j+1} = \sum_{\substack{T \text{ tree obtained by compression} \\ \text{of a polygon of } 2j \text{ vertices}}} (-1)^{|V_w(T)|+1} N(T), \quad (103)$$

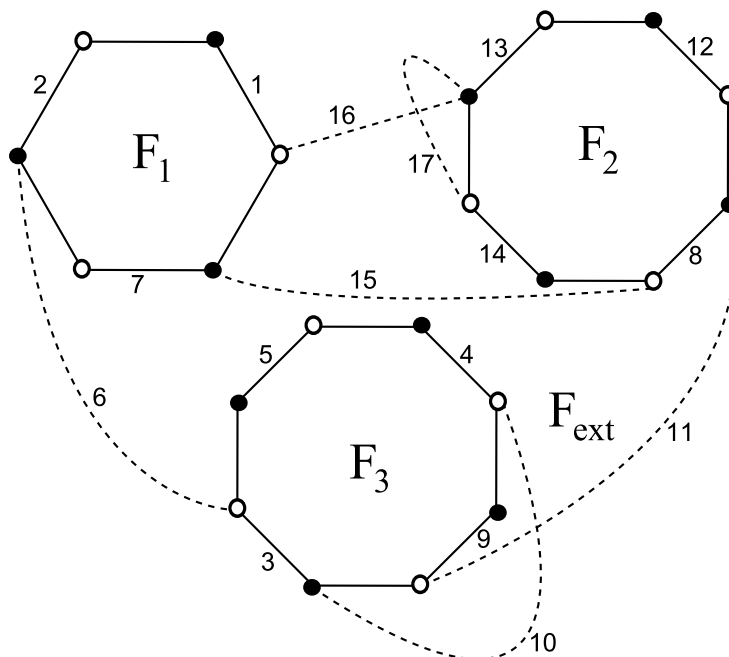

FIG. 6.9 – Example of a well-labeled cumulant map of resultant (1 ... 17)

as power series in \mathbf{p} and \mathbf{q} (where $|V_w(T)|$ is the number of white vertices of T). If we consider a polygon without the labels $1', 1, \dots, j', j$, the bijection between $NC(j)$ and the different ways to compress it as a tree is only defined up to a rotation of the polygon but this formula is still true.

Given a cumulant map \mathcal{M} , consider all maps M obtained from $M_{\mathcal{M}}$ by compressing each F_i into a tree (we do not touch the edges - dotted in our example - which do not belong to any face F_i). Such maps M have the same number of connected components as \mathcal{M} and are maps of pairs of permutations whose product is the resultant of \mathcal{M} . The disjoint union of the trees obtained by compression of the face F_i is a covering forest of M with no trivial trees (i.e. with only one vertex), which is denoted F_M .

Example. The map M of the figure 6.10 can be obtained from the cumulant map of the figure 6.9 by compressing each polygon into a tree in a certain way. The corresponding forest F_M can be seen on the figure by erasing the dotted edges.

Let \mathcal{M} be a cumulant map of resultant σ . Consider the function

$$N_{\mathcal{M}} : \{(\tau, \bar{\tau}) \in S(k) \times S(k) \text{ s.t. } \tau\bar{\tau} = \sigma\} \rightarrow \mathbb{C}[[\mathbf{p}, \mathbf{q}]],$$

defined by :

- If the map $M^{\tau, \bar{\tau}}$ is obtained from $M_{\mathcal{M}}$ by compressing in a certain way (necessarily unique) the faces F_1, \dots, F_t , we put :

$$N_{\mathcal{M}}(\tau, \bar{\tau}) = N(F_{M^{\tau, \bar{\tau}}}).$$

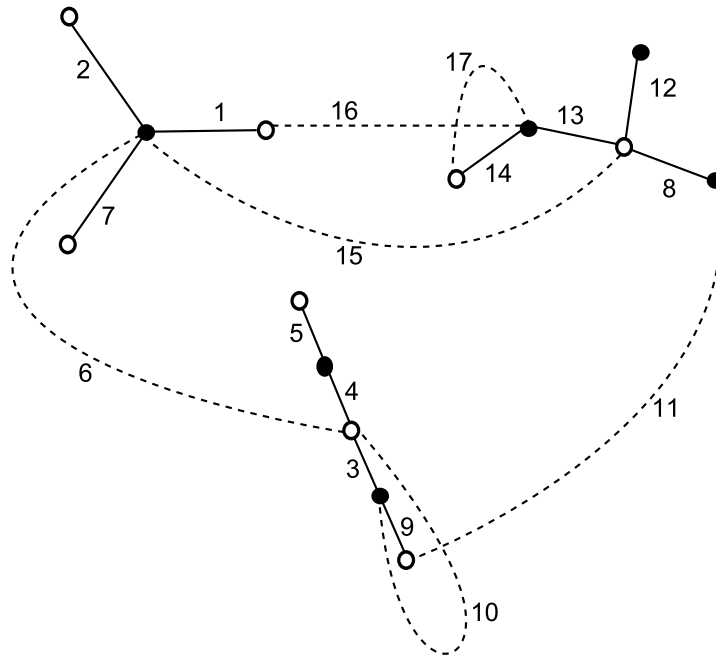

FIG. 6.10 – Example of a map obtained by compressing the polygons of the cumulant map of figure 6.9.

– Else $N_{\mathcal{M}}(\tau, \bar{\tau}) = 0$.

This function fulfills :

$$\sum_{\substack{\tau, \bar{\tau} \in S(k) \\ \tau \bar{\tau} = \sigma_{\mathcal{M}}}} (-1)^{|C(\tau)| + t_{\mathcal{M}}} N_{\mathcal{M}}(\tau, \bar{\tau}) = \prod_{i=1}^{t_{\mathcal{M}}} R_{j_i+1}. \tag{104}$$

Proof. Use formula (103) in the right hand side and expand it : the non-zero terms of the two sides of equality are exactly the same (with same signs because M and F_M always have the same number of white vertices). \square

Thanks to this property, this type of functions are a good tool to put series associated to forests together to make product of free cumulants appear.

Remark. Let \mathcal{M} be a cumulant map of resultant σ . The sets

$$\left\{ \tau \in S(k) \text{ such that } N_{\mathcal{M}}(\tau, \tau^{-1}\sigma) \neq 0 \right\}$$

$$\text{and } \left\{ \bar{\tau} \in S(k) \text{ such that } N_{\mathcal{M}}(\sigma\bar{\tau}^{-1}, \bar{\tau}) \neq 0 \right\}$$

are intervals $I_{\mathcal{M}}$ and $\overline{I_{\mathcal{M}}}$ of the symmetric group. So they are isomorphic as posets to products of non-crossing partition sets (for the order described in paragraph 6.1.3). The power series $N_{\mathcal{M}}(\tau, \tau^{-1}\sigma)$ is simply the one associated to the image of τ by this isomorphism (this image is defined up to the action of the full cycle on non-crossing partitions, so the associated power series is well-defined) and equation (91) is a consequence of this fact.

6.4.2 Multiplicities

As for classical maps in paragraph 6.3.2, we define a decomposition operator for cumulant maps. Denote by $\mathbb{A}_{cm, \leq 1}$ the ring generated as \mathbb{Z} -module by the cumulant maps with at most one external half-edge by connected component. If \mathcal{M} is a cumulant map, denote by $M'_\mathcal{M}$ the map obtained by replacing, for each i , the face F_i by a vertex (this map is not bicolored but each edge has a privileged orientation : the former white to black orientation).

Definition-Proposition 6.18. *There exists a unique linear operator*

$$\mathcal{D} : \mathbb{A}_{cm, \leq 1} \rightarrow \mathbb{A}_{cm, \leq 1}$$

such that :

- If $M'_\mathcal{M}$ has only one vertex, then $\mathcal{D}(\mathcal{M}) = \mathcal{M}$;
- If \mathcal{M} has more than one connected components ($\mathcal{M} = \prod_i \mathcal{M}^i$), then one has $\mathcal{D}(\mathcal{M}) = \prod \mathcal{D}(\mathcal{M}^i)$;
- If \mathcal{M} has only one connected component and no external half-edge, let h be the half-edge of black extremity of its edge with the smallest label. We denote by $\overline{\mathcal{M}}$ the cumulant map obtained by adding one external half-edge between h and its successor (as some edges have no labels, the half-edge is never in one of the faces F_i). Then $\mathcal{D}(\mathcal{M}) = \mathcal{D}(\overline{\mathcal{M}})$
- If $M'_\mathcal{M}$ has only one connected component with one half-edge but no admissible loops, denote by e_1, \dots, e_l the edges leaving the same face F_{i_0} as the external half-edge. The map $M_\mathcal{M} \setminus F_{i_0}$ has l connected components M_1, \dots, M_l , each with an external half-edge (at the place where e_i leaves M_i). These maps have a cumulant map structure $M_i = M_{\mathcal{M}_i}$. Then $\mathcal{D}(\mathcal{M})$ is given by the formula :

$$\mathcal{D}(\mathcal{M}) = \phi_\mathcal{M}(\mathcal{D}(\mathcal{M}_1), \dots, \mathcal{D}(\mathcal{M}_l)),$$

where $\phi_\mathcal{M}$ is the multilinear operator on algebraic sums of sub-cumulant maps of the M_i 's defined as ϕ_M in paragraph 6.3.2.

- Else, consider $D_1(M'_\mathcal{M})$ thanks to remark 6.3.1. In each map of the result, replace the vertices by faces F_i and denote the resulting sum of cumulant map by $CM(D_1(M'_\mathcal{M}))$. Then,

$$\mathcal{D}(\mathcal{M}) = \mathcal{D}(CM(D_1(M'_\mathcal{M}))).$$

Définition 6.7. The multiplicity $c(\mathcal{M})$ of a cumulant map \mathcal{M} is the coefficient of the disjoint union of the faces F_i in the decomposition $\mathcal{D}(\mathcal{M})$ multiplied by $(-1)^{t_\mathcal{M}-1}$ (it can be zero!).

Proposition 6.17 is also true for cumulant maps and \mathcal{D} . So $c(\mathcal{M})$ is non-negative if \mathcal{M} is connected.

If M is a map and F_M a covering forest without trivial trees of M , denote by \mathcal{M}_{M, F_M} the cumulant map obtained by replacing in M each tree of F_M by a polygon. The corresponding map M'_{M, F_M} is obtained from M by replacing all trees of F_M by a vertex. So the edges of $M \setminus F_M$ are in bijection with those of M'_{M, F_M} .

Lemma 6.19. *For any bicolored labeled map M , one has*

$$D(M) = \sum_{F_M \subset M} (-1)^{t_{F_M}-1} c(\mathcal{M}_{M,F_M}) F_M,$$

where the sum runs over covering forests of M with no trivial trees.

Proof. Let $F_M \subset M$ be a covering forest with no trivial trees of a bicolored labeled map. The operator D applied to M consists in making transformations of type T_L with restricted choices until there are only forests left. Thanks to remark 6.3.2, we choose loops containing a vertex of T_\star (the tree of F_M containing the external half-edge) as long as possible. As we are interested in the coefficient of F_M , we can forget at each step all maps that do not contain F_M . Now we notice that doing an elementary transformation with respect to L and keeping only maps containing F_M is equivalent to applying formula (98) with $E(L) \cap (M \setminus F_M)$ instead of $E(L)$.

As edges of $M \setminus F_M$ are in bijection with edges of M'_{M,F_M} , this new set of erasable edges is a set of edges of M'_{M,F_M} . With our choice of order of loops, this set of edges of M'_{M,F_M} is always the set of erasable edges of an admissible transformation. So, computing $D(F_M)$ and keep only the submap containing F_M is the same thing as computing $\mathcal{D}(\mathcal{M}_{M,F_M})$, except that we have trees instead of the polygonal faces. This shows that the coefficient of F_M in $D(M)$ is the same as the one of the unions of the faces F_i in $\mathcal{D}(\mathcal{M}_{M,F_M})$. The lemma is now obvious with the definition of the multiplicity of cumulant maps. \square

With the notation of the previous paragraph, the lemma implies :

$$N(D(M^{\tau, \bar{\tau}})) = \sum_{\substack{\mathcal{M} \text{ cumulant maps} \\ \text{of resultant } \sigma}} (-1)^{t_{\mathcal{M}}-1} c(\mathcal{M}) N_{\mathcal{M}}(\tau, \bar{\tau}). \quad (105)$$

Remark. By remark 6.4.1 and lemma 6.19, for every $\sigma \in S(k)$, the family of intervals $I_{\mathcal{M}}$, where \mathcal{M} describes the set of cumulant maps of resultant σ with multiplicities $(-1)^{t_{\mathcal{M}}-1} c(\mathcal{M})$, is a signed covering (the sum of multiplicities of intervals containing a given permutation is 1) of the symmetric group by intervals $[\pi, \pi']$ such that

- The quantity $|C(\tau)| + |C(\tau^{-1}\sigma)|$ is constant on these intervals ;
- The intervals are centered : $|C(\pi^{-1}\sigma)| = |C(\pi')|$.

Note that the power series N does not appear in this result but is central in our construction. This interpretation of Kerov's polynomials' coefficients was conjecturally suggested by P. Biane in [Bia03].

6.4.3 End of the proof of main theorem

We use the D -invariance of N to write Σ'_μ as an algebraic sum of power series associated to minimal factorizations :

$$\begin{aligned} \Sigma'_\mu &= \sum_{\substack{\tau, \bar{\tau} \in S(k) \\ \tau \bar{\tau} = \sigma \\ \langle \tau, \bar{\tau} \rangle \text{ trans.}}} (-1)^{|C(\tau)|+1} N(D(M^{\tau, \bar{\tau}})); \\ &= \sum_{\substack{\tau, \bar{\tau} \in S(k) \\ \tau \bar{\tau} = \sigma \\ \langle \tau, \bar{\tau} \rangle \text{ trans.}}} (-1)^{|C(\tau)|+1} \left[\sum_{\substack{\mathcal{M} \text{ cumulant maps} \\ \text{of resultant } \sigma}} (-1)^{t_{\mathcal{M}}-1} c(\mathcal{M}) N_{\mathcal{M}}(\tau, \bar{\tau}) \right]. \end{aligned}$$

The second equality is just equation (105). Now, we change the order of summation (note that transitive factorizations have connected maps, so appear only as compressions of connected cumulant maps) and use (104) :

$$\begin{aligned} \Sigma'_\mu &= \sum_{\substack{\mathcal{M} \text{ connected} \\ \text{cumulant map of} \\ \text{resultant } \sigma}} c(\mathcal{M}) \left[\sum_{\substack{\tau, \bar{\tau} \in S(k) \\ \tau \bar{\tau} = \sigma}} (-1)^{|C(\tau)|+t_{\mathcal{M}}} N_{\mathcal{M}}(\tau, \bar{\tau}) \right]; \\ &= \sum_{\substack{\mathcal{M} \text{ connected} \\ \text{cumulant map of} \\ \text{resultant } \sigma}} c(\mathcal{M}) \left[\prod_{i=1}^{t_{\mathcal{M}}} R_{j_i(\mathcal{M})+1} \right]. \end{aligned} \tag{106}$$

This ends the proof of theorem 6.7 because :

- the multiplicity of a connected cumulant map is non negative ;
- the monomials in the R_i 's are linearly independent as power series in \mathbf{p} and \mathbf{q} .

6.5 Computation of some particular coefficients

6.5.1 How to compute coefficients ?

In the proof of the main theorem, we have observed that the coefficient of the monomial $\prod_{i=1}^t R_{j_i+1}$ in K'_μ is the sum of $c(\mathcal{M})$ over all connected cumulant maps \mathcal{M} of resultant σ , with t polygons of respective sizes $2j_1, \dots, 2j_t$.

But it is easier to look, instead of the connected cumulant map \mathcal{M} , at the map M_0 obtained from $M_{\mathcal{M}}$ by compressing each polygon in a tree with only one black vertex. Recall that, in this context, F_M is the disjoint union of these trees. Thanks lemma 6.19, the coefficient of F_M in $D(M)$ is, up to a sign, equal $c(\mathcal{M})$. Note that each pair (M, F_M) , where M is the map of a transitive decomposition of σ and F_M a covering forest whose trees have exactly one black vertex and at least a white one, can be obtained this way from one cumulant map \mathcal{M} .

This remark leads to the following proposition, which will be used for explicit computations in the next paragraphs :

Proposition 6.20. *The coefficient of monomial $\prod_{i=1}^t R_{j_i+1}$ in K'_μ is the coefficient of the disjoint union of t trees with one black and respectively j_1, \dots, j_t white vertices in*

$$(-1)^{t-1} \sum_{\substack{\tau, \bar{\tau} \in S(k) \\ \tau \bar{\tau} = \sigma, \langle \tau, \bar{\tau} \rangle \text{ trans.} \\ |C(\bar{\tau})| = t}} D(M^{\tau, \bar{\tau}}).$$

As remarked before for coefficients of monomials of low degree, all the coefficients can be computed by counting some statistics on permutations in $S(k)$ (which can be much smaller than the symmetric group whose character values we are looking for).

6.5.2 Low degrees in R

6.5.2.1 Linear coefficients

A direct consequence of proposition 6.20 is the (well-known) combinatorial interpretation of coefficients of linear monomials in \mathbf{R} : the coefficient of R_{l+1} in K'_μ (or equivalently in K_μ) is the number of permutations $\tau \in S(k)$ with l cycles whose complementary $\bar{\tau} = \tau^{-1}\sigma$ is a full cycle, that is to say exactly the number of factorizations of σ , whose map has exactly one black vertex and l whites. Indeed, if M is a map with one black vertex, it is connected and has only loops of length 2. So transformations with respect to these loops just consist in erasing an edge and $D(M)$ is a tree with one black vertex and as many white vertices as M .

6.5.2.2 Quadratic coefficients

We have to compute $D(M)$, where M is a connected map with two black vertices. Denote w_0, \dots, w_u the white vertices of M linked to both black vertices. The first step is the computation of $D_1(\tilde{M})$, where \tilde{M} is M with an external half-edge h (see definition 6.16).

We begin by transformations with respect to all loops of length 2 going through the extremity \star of h . So we suppose that every w_i is linked by only one edge e_i to \star , but there can be more than one edge between w_i and the other black vertex v , so we denote by \mathbf{f}_i the family of these edges. Let $e_i = \{h_i, h'_i\}$, where the extremity of h_i is \star . With a good choice of numbering for the w_i , the cyclic order at \star induces the order h, h_0, \dots, h_u .

Lemma 6.21. *With these notations, we have :*

$$D_1(\tilde{M}) = \sum_{i=0}^u \tilde{M} \setminus \{\mathbf{f}_0, \dots, \mathbf{f}_{i-1}, e_{i+1}, \dots, e_u\} - \sum_{i=1}^u \tilde{M} \setminus \{\mathbf{f}_0, \dots, \mathbf{f}_{i-1}, e_i, \dots, e_u\}. \quad (107)$$

An exemple for $u = 3$ is drawn on figure 6.11.

Proof. If $u = 0$, there is no admissible loop and this result is $D_1(\tilde{M}) = \tilde{M}$. The case $u = 1$ is left to the reader (it is an easy induction on the number of edge in \mathbf{f}_0 , the case where \mathbf{f}_0 has

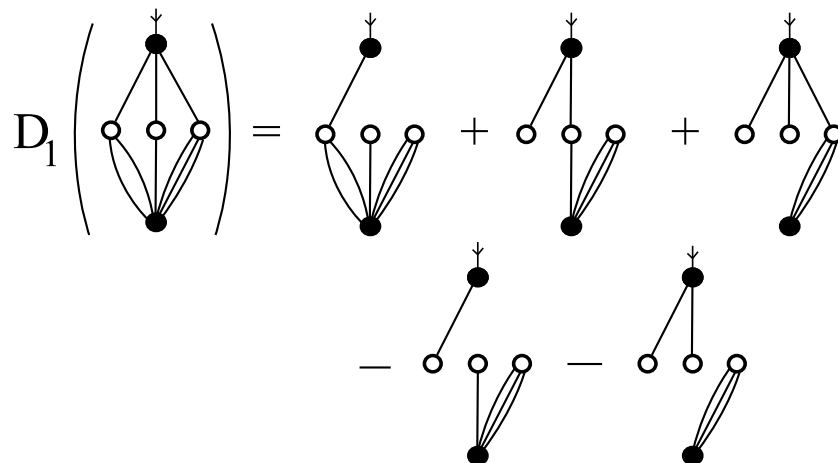

FIG. 6.11 – Elementary decomposition of a map with two black vertexes

two elements is contained in the case $H = 2$ in the proof of definition-theorem 6.13). Then we proceed by induction on u by using the formula :

$$D_1(\tilde{M}) = D_1(D_1(\tilde{M} \setminus \{e_u\}) \cup \{e_u\}).$$

Suppose that lemma is true for $u - 1$:

$$D_1(\tilde{M} \setminus \{e_u\}) \cup \{e_u\} = \sum_{i=0}^{u-1} \tilde{M} \setminus \{\mathbf{f}_0, \dots, \mathbf{f}_{i-1}, e_{i+1}, \dots, e_{u-1}\} - \sum_{i=1}^{u-1} \tilde{M} \setminus \{\mathbf{f}_0, \dots, \mathbf{f}_{i-1}, e_i, \dots, e_{u-1}\}. \tag{108}$$

The graphs of the first line still have admissible loops. To compute their image by D_1 , we have to compute the image of the submaps whose set of edges is $\{e_i, \mathbf{f}_i, e_u, \mathbf{f}_u\}$, since all other edges do not belong to any admissible loops. This is an application of the case $u = 1$:

$$D_1(\tilde{M} \setminus \{\mathbf{f}_0, \dots, \mathbf{f}_{i-1}, e_{i+1}, \dots, e_{u-1}\}) = \tilde{M} \setminus \{\mathbf{f}_0, \dots, \mathbf{f}_{i-1}, \mathbf{f}_i, e_{i+1}, \dots, e_{u-1}\} + \tilde{M} \setminus \{\mathbf{f}_0, \dots, \mathbf{f}_{i-1}, e_{i+1}, \dots, e_{u-1}, e_u\} - \tilde{M} \setminus \{\mathbf{f}_0, \dots, \mathbf{f}_{i-1}, \mathbf{f}_i, e_{i+1}, \dots, e_{u-1}, e_u\}.$$

Using this formula for each i , the first summand balances with the negative term in (108) (except for $i = u - 1$) and the two other summands are exactly the ones in (107). So the lemma is proved by induction. \square

Now, in all maps appearing in $D_1(\tilde{M})$, there are only loops of length 2, so the end of the decomposition algorithm consists in erasing some edges without changing the number of connected components.

As explained in proposition 6.20, we have to look at the sizes of trees in the two-tree forests (these forests come from the second sum of the right member of (107)). If, in M , there

are h_M^1 white vertices linked to \star (including the w_i) and h_M^2 to v , we obtain pairs of trees with h^1 and h^2 vertices, where h^1 and h^2 take all integer values satisfying the conditions :

$$\begin{cases} h^1 - 1 < h_M^1; \\ h^2 - 1 < h_M^2; \\ h^1 + h^2 = |V_w(M)|. \end{cases}$$

So any permutation with two black vertices contributes to coefficients of $R_{h^1}R_{h^2}$, where h^1 and h^2 verify the condition above. If $j \neq l$, a permutation may contribute twice to the coefficient of R_jR_l if the conditions above are fulfilled for $j = h^1, l = h^2$ and for $l = h^1, j = h^2$. Finally, one has :

$$[R_jR_l]K_k = \begin{cases} 1 & \text{if } j \neq l \\ 1/2 & \text{if } j = l \end{cases} \cdot \sum_{\substack{\tau, \bar{\tau} \in S(k) \\ \tau \bar{\tau} = \sigma, \langle \tau, \bar{\tau} \rangle \text{ trans.} \\ |C(\bar{\tau})|=2}} \delta_{j \leq h_{M\tau, \bar{\tau}}^1} \delta_{l \leq h_{M\tau, \bar{\tau}}^2} + \delta_{l \leq h_{M\tau, \bar{\tau}}^1} \delta_{j \leq h_{M\tau, \bar{\tau}}^2},$$

which is exactly the second part of theorem 6.5 (the second δ in the equation above disappears if we consider permutations with numbered cycles).

6.5.3 High degrees in p, q

If the graded degree in \mathbf{p} and \mathbf{q} is high, the maps we are dealing with have few loops. Therefore, it is easier to compute their image by D and to count them.

Proof of theorem 6.8. Let r, s, t, j_1, \dots, j_t be integers such that $\sum j_i = r + s$. As in the whole paper $\sigma \in S(k)$ is a permutation of type μ (here r, s). We can suppose that 1 is in the support of the cycle c_1 of σ of size s .

We have to count connected maps with $r + s$ edges and $r + s$ vertices, that is to say, up to a change of orientation, one loop L . So, eventually by replacing L by L' (if 1 is in the word associated to the external face, L must be going counterclockwise), $D(M) = T_L(M)$. Only maps M such that, in $D(M)$, there is (at least) a forest with one black vertex per tree, contribute to coefficients of Kerov's polynomials. In such maps, all vertices of $M \setminus L$ are white and only the forest $M \setminus E(L)$ (see formula (98)) satisfies the condition above.

Let us consider such a map M . We can choose arbitrarily a first black vertex b_1 of M (M will be said marked) and number b_1, \dots, b_t all its black vertices in the order of L . Suppose that there are w_i white vertices of $M \setminus L$ linked to b_i . Then M contributes only to the coefficient of $\prod R_{w_i+2}$ in K'_{f_1, f_2} (where $2f_1$ and $2f_2$ are the lengths of the two faces of M) with coefficient 1.

We count the number of marked labeled maps M contributing to the coefficient of $\prod_{i=1}^t R_{j_i}$ in $K'_{r, s}$. They are of the form of the figure 6.12 with :

- The word $(r_1 + s_1, r_2 + s_2, \dots, r_t + s_t)$ is equal up to a permutation to $(j_1 - 2, \dots, j_t - 2)$
- The length $r_1 + r_2 + \dots + r_t$ of the face F_r which is on the left side of L , is equal to r .

Such a map can be labeled of $r \cdot s$ different ways such that its faces are the cycles of σ . Indeed, if we fix one element in the support of each cycle of σ , such a labeling is determined

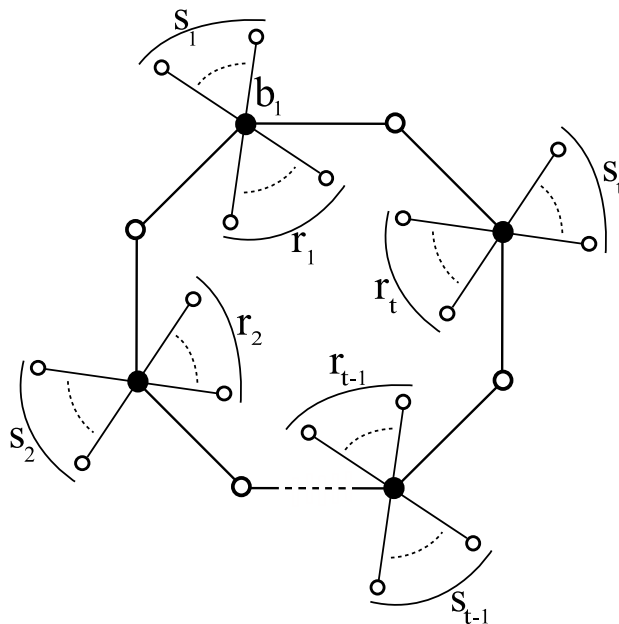

FIG. 6.12 – Maps contributing to terms of graded degree $r + s$ in $K'_{r,s}$.

by the edges labeled by these elements. We have r (resp. s) choices for the first (resp. second) one : the r (resp. s) edges whose labels are in the word associated to the face F_r (resp. F_s). As we deal for the moment with maps with a marked black vertex, all the numberings give a different map.

If we choose a permutation $\mathbf{j}' - 2$ of the word $(j_1 - 2, \dots, j_t - 2)$, non-negative integers $r_1, s_1, \dots, r_t, s_t$ such that $\sum_i r_i = r - t, \sum_i s_i = s - t$ and $\mathbf{r} + \mathbf{s} = \mathbf{j}' - 2$ and labels on the corresponding map, we obtain a marked map M contributing to the coefficient of $\prod_{i=1}^t R_{j_i}$ in $K'_{r,s}$. To obtain the number of such non-marked maps, we have to divide by t (thanks to the labels, there is no problem of symmetry).

So the coefficient of $\prod_{i=1}^t R_{j_i}$ in $K'_{r,s}$ is

$$\frac{r \cdot s}{t} \text{Perm}(\mathbf{j}) |\{(r_1, s_1, \dots, r_t, s_t)\}|,$$

where $r_1, s_1, \dots, r_t, s_t$ describe the set of non-negative integers satisfying the equations

$$\begin{cases} r_1 + s_1 = j_1 - 2; \\ \vdots \\ r_t + s_t = j_t - 2; \\ r_1 + \dots + r_t = r - t. \end{cases}$$

But, in the system of equations satisfied by the r_i 's and the s_i 's, we can forget the s_i 's and only keep an inequality on each r_i ($r_i \leq j_i - 2$), which corresponds to the positivity of

s_i . So the cardinal of the set in the formula above is exactly $N(j_1 - 2, \dots, j_t - 2; r - t)$

□

We use the same ideas for subdominant term in the case $l(\mu) = 1$.

proof of theorem 6.4. To compute the coefficients of a monomial of graded degree $k - 1$ in K_k , we have to count the contributions of labeled maps with k edges, $k - 1$ vertices and one face. As in the previous proof, if a map has a non-zero contribution, all vertices which do not belong to any loop are white. Such maps can be sorted in five classes : see figure 6.13 for types a and b , type c (resp. d) is type b with one black and one white (resp. two white) vertices at the extremities and type e is type a with a white central vertex of valence 4 instead of a black one.

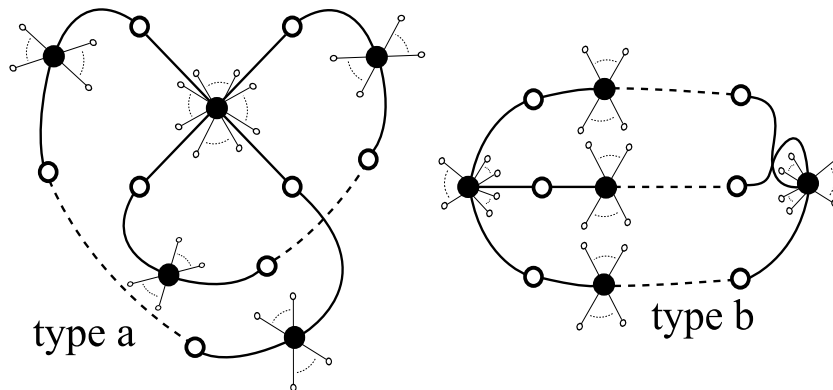

FIG. 6.13 – Maps contributing to terms of graded degree $k - 1$ in K_k .

Thanks to the case $H = 2$ in the proof of definition-theorem 6.13, the decomposition of these maps is easy to compute :

Types a and e : The two loops have no edges in common and their associated transformations commute ;

Types b, c and d : We obtain a result close to the one of figure 6.5.

Here is the description of the forests with t trees for each type (it is quite surprising that it does not depend on the labels).

Type a : In $D(M)$, there is one forest F with one black star per tree : in addition to those which do not belong to loops, there are two white vertices linked to the central black vertex and one to each other black vertex.

Type b : In $D(M)$, there are two forests F_1 and F_2 with one black star per tree : in F_1 (resp. in F_2), in addition to those which do not belong to loops, there are two white vertices linked to the vertex at the left (resp. right) extremity and one to each other black vertex (including the right (resp. left) extremity).

Type c : In $D(M)$, there is one forest F with one black vertex per tree : in addition to those which do not belong to loops, there is one white vertex linked to each black vertex.

Types d and e : In $D(M)$, there is no forest F with one black vertex per tree.

Now we compute the coefficient of $\prod_{i=1}^t R_{j_i}$ in K_k . We give all the details only for the contributions of maps of type a .

If we mark an half-edge of extremity the central black vertex in a map M of type a , we number the black vertices of M by following the face of M beginning by this half-edge (but not by the central black vertex). As in the previous proof, a map contributing to this monomial with a marked half-edge of extremity the central black vertex (4 choices) is given by :

- A permutation \mathbf{j}' of the word (j_1, \dots, j_t) (j'_i is the number of vertices of the tree of F of black vertex b_i).
- The length of the first loop, i.e. the label $p \in [t]$ of the central black vertex.
- For each black vertex different from the central one, we have to link $j'_i - 2$ white vertices that do not belong to loops. We have to fix the number of these vertices which are on a given side of the loop : there is $j'_i - 1$ possibility.
- Idem for the central black vertex except that we have $j'_p - 3$ white vertices to place in 4 sides, so $\binom{j'_p}{3}$ possibilities.
- The labels of such a map are determined by the choice of one edge which has the label 1, so k possibilities.

Finally the contribution of type a maps to the coefficient of $\prod_{i=1}^t R_{j_i}$ in K_k is

$$C_a = \frac{k}{4} \sum_{\mathbf{j}'} \left[\sum_{p=1}^t \frac{j'_p(j'_p - 2)}{6} \prod_{i=1}^t (j'_i - 1) \right].$$

The expression in the bracket is symmetric in \mathbf{j}' , so equal to its value for \mathbf{j} :

$$C_a = \frac{k}{4} |\text{Perm}(\mathbf{j})| \prod_{i=1}^t (j_i - 1) \sum_{p=1}^t \frac{j_p(j_p - 2)}{6}.$$

We can find similar arguments for types b and c :

- In type b , p_1 and p_2 are the labels of the black vertices at the extremities if we numbered by following the face beginning just after an extremity (6 possibilities to choose where to begin) ;
- In type c , p_1 is the label of the black extremity and p_2 of the black vertex preceding the white extremity if we begin just after the white extremity (3 possibilities to choose where to begin), note also that in this type we have to symmetrize our expression in \mathbf{j}' .

We obtain :

$$C_b = \frac{k}{6} |\text{Perm}(\mathbf{j})| \prod_{i=1}^t (j_i - 1) \sum_{1 \leq p_1 < p_2 \leq t} \frac{j_{p_1}(j_{p_2} - 2)}{4} + \frac{j_{p_2}(j_{p_1} - 2)}{4};$$

$$C_c = \frac{k}{3} |\text{Perm}(\mathbf{j})| \prod_{i=1}^t (j_i - 1) \sum_{1 \leq p_1 \leq p_2 \leq t} \frac{1}{2} \left(\frac{j_{p_1}}{2} + \frac{j_{p_2}}{2} \right).$$

Finally, if we note

$$A = \frac{k}{24} |\text{Perm}(\mathbf{j})| \prod_{i=1}^t (j_i - 1),$$

and split the summation in C_c into the cases $j_{p_1} < j_{p_2}$ and $j_{p_1} = j_{p_2}$, the coefficient we are looking for is :

$$\begin{aligned} C_a + C_b + C_c &= A \left(\sum_{p=1}^t j_p(j_p - 2) + \sum_{1 \leq p_1 \leq t} 4j_{p_1} \right. \\ &\quad \left. + \sum_{1 \leq p_1 < p_2 \leq t} (j_{p_1}(j_{p_2} - 2) + j_{p_2}(j_{p_1} - 2) + 2j_{p_1} + 2j_{p_2}) \right); \\ &= A \left(2 \sum_{p=1}^t j_p + \sum_{p=1}^t j_p^2 + \sum_{1 \leq p_1 < p_2 \leq t} (j_{p_1}j_{p_2} + j_{p_2}j_{p_1}) \right); \\ &= A \left[\left(\sum_{p=1}^t j_p \right)^2 + 2 \sum_{p=1}^t j_p \right]; \\ &= A((k-1)^2 + 2(k-1)) = A(k-1)(k+1), \end{aligned}$$

which is exactly the expression claimed in theorem 6.4. □

7

Explicit combinatorial interpretation of the coefficients of Kerov polynomials

Ce chapitre reprend le contenu de l'article [DFŚ08], écrit en collaboration avec Piotr Śniady et Macej Dołęga.

This chapter corresponds to the article [DFŚ08], written with Piotr Śniady and Macej Dołęga and submitted.

Résumé

Dans ce chapitre, nous établissons une interprétation combinatoire explicite des coefficients des polynômes de Kerov qui permettent d'exprimer les caractères irréductibles normalisés du groupe symétrique $S(n)$ en fonction des cumulants libres du diagramme de Young associé. Ceux-ci comptent certaines factorisations d'une permutation fixée.

Abstract

We find an explicit combinatorial interpretation of the coefficients of Kerov character polynomials which express the value of normalized irreducible characters of the symmetric groups $S(n)$ in terms of free cumulants R_2, R_3, \dots of the corresponding Young diagram. Our interpretation is based on counting certain factorizations of a given permutation.

7.1 Introduction

7.1.1 Generalized Young diagrams

We are interested in the asymptotics of irreducible representations of the symmetric groups $\mathfrak{S}(n)$ for $n \rightarrow \infty$ in the scaling of *balanced Young diagrams* which means that

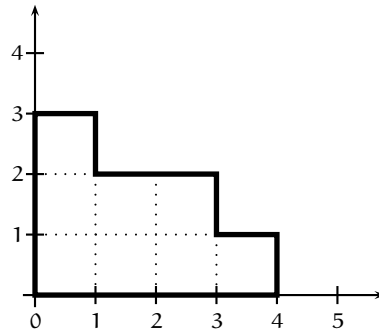
FIG. 7.1 – Young diagram $(4, 3, 1)$ drawn in the French convention

we consider a sequence $(\lambda^{(n)})$ of Young diagrams with a property that $\lambda^{(n)}$ has n boxes and $O(\sqrt{n})$ rows and columns. This scaling makes the graphical representations of Young diagrams particularly useful; in this article we will use two conventions for drawing Young diagrams : the French (presented on Figure 7.1) and the Russian one (presented on Figure 7.2). Notice that the graphs in the Russian convention are created from the graphs in the French convention by rotating counterclockwise by $\frac{\pi}{4}$ and by scaling by a factor $\sqrt{2}$.

Any Young diagram drawn in the French convention can be identified with its graph which is equal to the set $\{(x, y) : 0 \leq x, 0 \leq y \leq f(x)\}$ for a suitably chosen function $f : \mathbb{R}_+ \rightarrow \mathbb{R}_+$, where $\mathbb{R}_+ = [0, \infty)$. It is therefore natural to define the set of *generalized Young diagrams* \mathcal{Y} (*in the French convention*) as the set of bounded, non-increasing functions $f : \mathbb{R}_+ \rightarrow \mathbb{R}_+$ with a compact support; in this way any Young diagram can be regarded as a generalized Young diagram.

We can identify a Young diagram drawn in the Russian convention with its profile, see Figure 7.2. It is therefore natural to define the set of *generalized Young diagrams* \mathcal{Y} (*in the Russian convention*) as the set of functions $f : \mathbb{R} \rightarrow \mathbb{R}_+$ which fulfill the following two conditions :

- f is a Lipschitz function with constant 1, i.e. $|f(x) - f(y)| \leq |x - y|$,
- $f(x) = |x|$ if $|x|$ is large enough.

At the first sight it might seem that we have defined the set \mathcal{Y} of generalized Young diagrams in two different ways, but we prefer to think that these two definitions are just two conventions (French and Russian) for drawing the same object. This will not lead to confusions since it will be always clear from the context which of the two conventions is being used.

The setup of generalized Young diagrams makes it possible to speak about dilations of Young diagrams. In the geometric language of French and Russian conventions such dilations simply correspond to dilations of the graph. Formally speaking, if $f \in \mathcal{Y}$ is a generalized Young diagram (no matter in which convention) and $s > 0$ is a real number we define the dilated diagram $sf \in \mathcal{Y}$ by the formula

$$(sf)(x) = sf\left(\frac{x}{s}\right).$$

This notion of dilation is very useful in the study of balanced Young diagrams because if

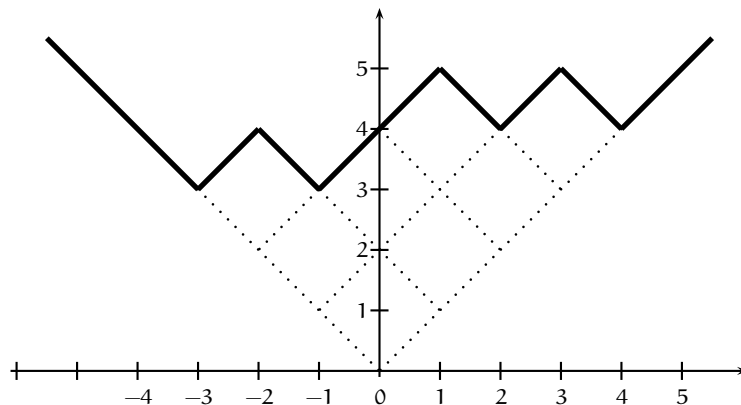

FIG. 7.2 – Young diagram $(4, 3, 1)$ drawn in the Russian convention. The profile of the diagram has been drawn in the solid line.

$(\lambda^{(n)})_n$ is a sequence of balanced Young diagrams we may for example ask questions about the limit of the sequence $\frac{1}{\sqrt{n}}\lambda^{(n)}$ [LS77, VK77].

7.1.2 Normalized characters

Any permutation $\pi \in \mathfrak{S}(k)$ can be also regarded as an element of $\mathfrak{S}(n)$ if $k \leq n$ (we just declare that $\pi \in \mathfrak{S}(n)$ has additional $n - k$ fixpoints). For any $\pi \in \mathfrak{S}(k)$ and an irreducible representation ρ^λ of the symmetric group $\mathfrak{S}(n)$ corresponding to the Young diagram λ we define the normalized character

$$\Sigma_\pi^\lambda = \begin{cases} \underbrace{n(n-1) \cdots (n-k+1)}_{k \text{ factors}} \frac{\text{Tr } \rho^\lambda(\pi)}{\text{dimension of } \rho^\lambda} & \text{if } k \leq n, \\ 0 & \text{otherwise.} \end{cases}$$

One of the reasons why such normalized characters are so useful in the asymptotic representation theory is that, as we shall see in Section 7.4, one can extend the definition of Σ_π^λ to the case when $\lambda \in \mathcal{Y}$ is a generalized Young diagram; furthermore computing their values will turn out to be easy.

Particularly interesting are the values of characters on cycles, therefore we will use the notation

$$\Sigma_k^\lambda = \Sigma_{(1,2,\dots,k)}^\lambda,$$

where we treat the cycle $(1, 2, \dots, k)$ as an element of $\mathfrak{S}(k)$ for any integer $k \geq 1$.

7.1.3 Free cumulants

Let λ be a (generalized) Young diagram. We define its *free cumulants* $R_2^\lambda, R_3^\lambda, \dots$ by the formula

$$R_k^\lambda = \lim_{s \rightarrow \infty} \frac{1}{s^k} \Sigma_{k-1}^{s\lambda}, \quad (109)$$

in other words each free cumulant is asymptotically the dominant term of the character on a cycle of appropriate length in the limit when the Young diagram tends to infinity.

From the above definition it is clear that free cumulants should be interesting for investigations of the asymptotics of characters of symmetric groups, but it is not obvious why the limit should exist and if there is some direct way of calculating it. In Sections 7.2 and 7.3 we will review some more conventional definitions of free cumulants and some more direct ways of calculating them.

One of the reasons why free cumulants are so useful in the asymptotic representation theory is that they are homogeneous with respect to dilations of the Young diagrams, namely

$$R_k^{s\lambda} = s^k R_k^\lambda;$$

in other words the degree of the free cumulant R_k is equal to k . This property is an immediate consequence of (109) but it also follows from more conservative definitions of free cumulants.

In fact, the notion of free cumulants originates from the work of Voiculescu [Voi86] where they appeared as coefficients of an R -series which turned out to be useful in description of *free convolution* in the context of *free probability theory* [VDN92]. The name of free cumulants was coined by Speicher [Spe98] who found their combinatorial interpretation and their relations with the lattice of non-crossing partitions [Spe93]. Since free probability theory is closely related to the random matrix theory [Voi91] free cumulants quickly became an important tool not only within the framework of free probability but in the random matrix theory as well.

7.1.4 Kerov character polynomials

The following surprising fact is fundamental for this article : it turns out that free cumulants can be used not only to provide asymptotic approximations for the characters of symmetric groups, but also for exact formulas. Kerov during a talk in Institut Henri Poincaré in January 2000 [Ker00] announced the following result (the first published proof was given by Biane [Bia03]) : for each permutation π there exists a universal polynomial K_π with integer coefficients, called *Kerov character polynomial*, with a property that

$$\Sigma_\pi^\lambda = K_\pi(R_2^\lambda, R_3^\lambda, \dots) \quad (110)$$

holds true for any (generalized) Young diagram λ . We say that Kerov polynomial is universal because it does not depend on the choice of λ . In order to keep the notation simple we make the dependence of the characters and of the free cumulants on λ implicit and we write

$$\Sigma_\pi = K_\pi(R_2, R_3, \dots).$$

As usual, we are mostly concerned with the values of the characters on the cycles, therefore we introduce special notation for such Kerov polynomials

$$\Sigma_k = K_k(R_2, R_3, \dots).$$

Kerov also found the leading term of the Kerov polynomial :

$$\Sigma_k = R_{k+1} + (\text{terms of degree at most } k - 1) \quad (111)$$

which has (109) as an immediate consequence.

The first few Kerov polynomials K_k are as follows [Bia01b] :

$$\begin{aligned}\Sigma_1 &= R_2, \\ \Sigma_2 &= R_3, \\ \Sigma_3 &= R_4 + R_2, \\ \Sigma_4 &= R_5 + 5R_3, \\ \Sigma_5 &= R_6 + 15R_4 + 5R_2^2 + 8R_2, \\ \Sigma_6 &= R_7 + 35R_5 + 35R_3R_2 + 84R_3.\end{aligned}$$

Based on such numerical evidence Kerov formulated during his talk [Ker00] the following conjecture.

Conjecture 7.1 (Kerov). *The coefficients of Kerov character polynomials K_k ($k \geq 1$) are non-negative integers.*

Biane [Bia03] stated a very interesting conjecture that the underlying reason for positivity of the coefficients of Kerov polynomials is that they are equal to cardinalities of some combinatorial objects. Biane provided also some heuristics what these combinatorial objects could be (we postpone the details until Section 7.1.11.1).

Since then a number of partial answers were found. Śniady [Śni06a] found explicitly the next term (with degree $k - 1$) in the expansion (111) (the form of this next term was conjectured by Biane [Bia03]). Goulden and Rattan [GR07] found an explicit but complicated formula for the coefficients of Kerov polynomials. These results, however, did not shed too much light into possible combinatorial interpretations of Kerov character polynomials.

Some light on the possible combinatorial interpretation of Kerov polynomials was shed by the following result proved by Biane in the aforementioned paper [Bia03] and Stanley [Sta02].

Theorem 7.2 (Linear terms of Kerov polynomials). *For all integers $l \geq 2$ and $k \geq 1$ the coefficient of R_l in the Kerov polynomial K_k is equal to the number of pairs (σ_1, σ_2) of permutations $\sigma_1, \sigma_2 \in \mathfrak{S}(k)$ such that $\sigma_1 \circ \sigma_2 = (1, 2, \dots, k)$ and such that σ_2 consists of one cycle and σ_1 consists of $l - 1$ cycles.*

For a permutation π we denote by $C(\pi)$ the set of cycles of π . Féray [Fér08a] extended the above result to the quadratic terms of Kerov polynomials.

Theorem 7.3 (Quadratic terms of Kerov polynomials). *For all integers $l_1, l_2 \geq 2$ and $k \geq 1$ the coefficient of $R_{l_1}R_{l_2}$ in the Kerov polynomial K_k is equal to the number of triples (σ_1, σ_2, q) with the following properties :*

- σ_1, σ_2 is a factorization of the cycle; in other words $\sigma_1, \sigma_2 \in \mathfrak{S}(k)$ are such that $\sigma_1 \circ \sigma_2 = (1, 2, \dots, k)$;
- σ_2 consists of two cycles and σ_1 consists of $l_1 + l_2 - 2$ cycles;
- $q : C(\sigma_2) \rightarrow \{l_1, l_2\}$ is a surjective map on the two cycles of σ_2 ;
- for each cycle $c \in C(\sigma_2)$ there are at least $q(c)$ cycles of σ_1 which intersect nontrivially c .

In fact, Féray [Fér08a] managed also to prove positivity of the coefficients of Kerov character polynomials by finding some combinatorial objects with appropriate cardinality, but his proof was so complicated that the resulting combinatorial objects were hardly explicit in more complex cases. We compare this work with our new result in Section 7.8

7.1.5 The main result : explicit combinatorial interpretation of the coefficients of Kerov polynomials

The following theorem is the main result of the paper : it gives a satisfactory answer for the Kerov conjecture by providing an explicit combinatorial interpretation of the coefficients of the Kerov polynomials. It was formulated for the first time as a conjecture in June 2008 by Valentin Féray and Piotr Śniady after some computer experiments concerning the coefficient of R_2^3 in Kerov polynomials K_7 and K_9 . The original formulation of the conjecture was Theorem 7.30 ; the form below was pointed out by Philippe Biane in a private communication.

Theorem 7.4 (The main result). *Let $k \geq 1$ and let s_2, s_3, \dots be a sequence of non-negative integers with only finitely many non-zero elements. The coefficient of $R_2^{s_2} R_3^{s_3} \dots$ in the Kerov polynomial K_k is equal to the number of triples (σ_1, σ_2, q) with the following properties :*

- (a) σ_1, σ_2 is a factorization of the cycle ; in other words $\sigma_1, \sigma_2 \in \mathfrak{S}(k)$ are such that $\sigma_1 \circ \sigma_2 = (1, 2, \dots, k)$;
- (b) the number of cycles of σ_2 is equal to the number of factors in the product $R_2^{s_2} R_3^{s_3} \dots$; in other words $|C(\sigma_2)| = s_2 + s_3 + \dots$;
- (c) the total number of cycles of σ_1 and σ_2 is equal to the degree of the product $R_2^{s_2} R_3^{s_3} \dots$; in other words $|C(\sigma_1)| + |C(\sigma_2)| = 2s_2 + 3s_3 + 4s_4 + \dots$;
- (d) $q : C(\sigma_2) \rightarrow \{2, 3, \dots\}$ is a coloring of the cycles of σ_2 with a property that each color $i \in \{2, 3, \dots\}$ is used exactly s_i times (informally, we can think that q is a map which to cycles of $C(\sigma_2)$ associates the factors in the product $R_2^{s_2} R_3^{s_3} \dots$) ;
- (e) for every set $A \subset C(\sigma_2)$ which is nontrivial (i.e., $A \neq \emptyset$ and $A \neq C(\sigma_2)$) there are more than $\sum_{i \in A} (q(i) - 1)$ cycles of σ_1 which intersect $\bigcup A$.

A careful reader may notice that condition (b) in the above theorem is redundant since it is implied by condition (d) ; we decided to keep it for the sake of clarity. We postpone presenting interpretations of condition (e) until Section 7.1.8 and Section 7.1.9.

One can easily see that Theorem 7.2 and Theorem 7.3 are special cases of the above result. We decided to postpone the discussion of other applications of this main result until Section 7.1.12 when more context will be available.

7.1.6 Characters for more complicated conjugacy classes

In order to study characters on more complicated conjugacy classes we will use the following notation. For $k_1, \dots, k_l \geq 1$ we define

$$\Sigma_{k_1, \dots, k_l}^\lambda = \Sigma_\pi^\lambda,$$

where $\pi \in \mathfrak{S}(k_1 + \dots + k_l)$ is any permutation with the lengths of the cycles given by k_1, \dots, k_l ; we may take for example $\pi = (1, 2, \dots, k_1)(k_1 + 1, k_1 + 2, \dots, k_1 + k_2) \dots$. For simplicity we will often suppress the explicit dependence of Σ_{k_1, \dots, k_l} on λ .

Unfortunately, as it was pointed out by Rattan and Śniady [RŚ08], Kerov conjecture is not true for more complicated Kerov polynomials K_π for which π consists of more than one cycle. However, they conjectured that it would still hold true if the definition (110) of Kerov polynomials was modified as follows.

For $k_1, \dots, k_l \geq 1$ we consider *cumulant* $\kappa^{\text{id}}(\Sigma_{k_1}, \dots, \Sigma_{k_l})$ of the conjugacy classes of cycles. Precise definition of these quantities can be found in [Śni06b], for the purpose of this article it is enough to know that their relation to the characters Σ_{k_1, \dots, k_l} is analogous to the relation between classical cumulants of random variables and their moments, as it can be seen on the following examples :

$$\begin{aligned} \Sigma_r &= \kappa^{\text{id}}(\Sigma_r), \\ \Sigma_{r,s} &= \kappa^{\text{id}}(\Sigma_r, \Sigma_s) + \kappa^{\text{id}}(\Sigma_r) \kappa^{\text{id}}(\Sigma_s), \\ \Sigma_{r,s,t} &= \kappa^{\text{id}}(\Sigma_r, \Sigma_s, \Sigma_t) + \kappa^{\text{id}}(\Sigma_r) \kappa^{\text{id}}(\Sigma_s, \Sigma_t) + \kappa^{\text{id}}(\Sigma_s) \kappa^{\text{id}}(\Sigma_r, \Sigma_t) + \\ &\quad \kappa^{\text{id}}(\Sigma_t) \kappa^{\text{id}}(\Sigma_r, \Sigma_s) + \kappa^{\text{id}}(\Sigma_r) \kappa^{\text{id}}(\Sigma_s) \kappa^{\text{id}}(\Sigma_s), \\ \kappa^{\text{id}}(\Sigma_r) &= \Sigma_r, \\ \kappa^{\text{id}}(\Sigma_r, \Sigma_s) &= \Sigma_{r,s} - \Sigma_r \Sigma_s, \\ \kappa^{\text{id}}(\Sigma_r, \Sigma_s, \Sigma_t) &= \Sigma_{r,s,t} - \Sigma_r \Sigma_{s,t} - \Sigma_s \Sigma_{r,t} - \Sigma_t \Sigma_{r,s} + 2 \Sigma_r \Sigma_s \Sigma_t. \end{aligned}$$

As it was pointed out in [Śni06b], the above quantities $\kappa^{\text{id}}(\Sigma_r, \Sigma_s, \dots)$ are very useful in the study of fluctuations of random Young diagrams; in fact they are even more fundamental than the characters $\Sigma_{r,s,\dots}$ themselves.

Conjecture 7.5 (Rattan, Śniady [RŚ08]). *For $k_1, \dots, k_l \geq 1$ there exists a universal polynomial K_{k_1, \dots, k_l} with non-negative integer coefficients, called generalized Kerov polynomial, such that*

$$(-1)^{l-1} \kappa^{\text{id}}(\Sigma_{k_1}, \dots, \Sigma_{k_l}) = K_{k_1, \dots, k_l}(R_2, R_3, \dots).$$

The coefficients of this polynomials have some combinatorial interpretation.

The existence of such a universal polynomial with integer coefficients follows directly from the work of Kerov. The positivity of the coefficients was proved by Féray [Fér08a] but his combinatorial interpretation of the coefficients was not very explicit.

In this article will will also prove the following generalization of Theorem 7.4 which gives an explicit combinatorial solution to Conjecture 7.5.

Theorem 7.6. *Let $k_1, \dots, k_l \geq 1$ and let s_1, s_2, \dots be a sequence of non-negative integers with only finitely many non-zero elements. The coefficient of $R_2^{s_2} R_3^{s_3} \dots$ in the generalized Kerov polynomial K_{k_1, \dots, k_l} is equal to the number of triples (σ_1, σ_2, q) which fulfill the same conditions as in Theorem 7.4 with the following modification : condition (a) should be replaced by the following one :*

(a') $\sigma_1, \sigma_2 \in \mathfrak{S}(k_1 + \dots + k_l)$ are such that

$$\sigma_1 \circ \sigma_2 = (1, 2, \dots, k_1)(k_1 + 1, k_1 + 2, \dots, k_1 + k_2) \dots$$

and the group $\langle \sigma_1, \sigma_2 \rangle$ acts transitively on the set $\{1, \dots, k_1 + \dots + k_l\}$.

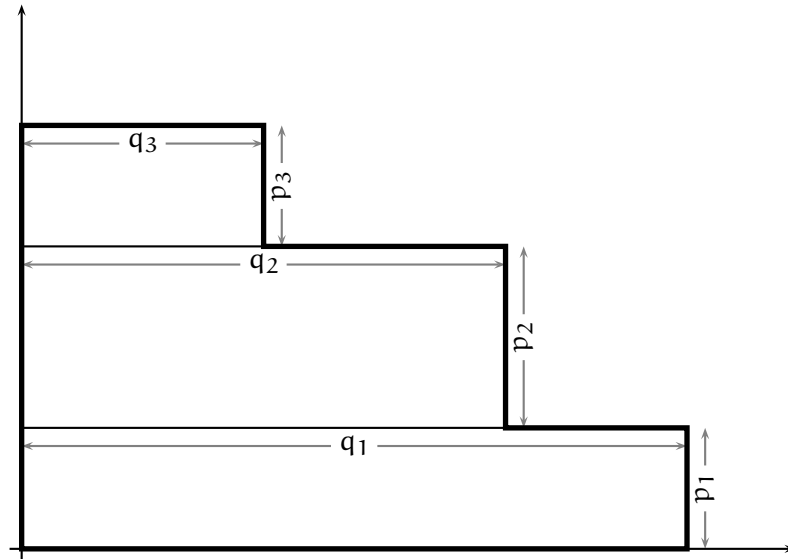

FIG. 7.3 – Generalized Young diagram $\mathbf{p} \times \mathbf{q}$ drawn in the French convention

7.1.7 Idea of the proof : Stanley polynomials

The main idea of the proof of the main result (Theorem 7.4 and Theorem 7.6) is to use Stanley polynomials which are defined as follows. For two finite sequences of positive real numbers $\mathbf{p} = (p_1, \dots, p_m)$ and $\mathbf{q} = (q_1, \dots, q_m)$ with $q_1 \geq \dots \geq q_m$ we consider a multirectangular generalized Young diagram $\mathbf{p} \times \mathbf{q}$, cf Figure 7.3. In the case when $p_1, \dots, p_m, q_1, \dots, q_m$ are natural numbers $\mathbf{p} \times \mathbf{q}$ is a partition

$$\mathbf{p} \times \mathbf{q} = (\underbrace{q_1, \dots, q_1}_{p_1 \text{ times}}, \underbrace{q_2, \dots, q_2}_{p_2 \text{ times}}, \dots).$$

If $\mathcal{F} : \mathcal{Y} \rightarrow \mathbb{R}$ is a sufficiently nice function on the set of generalized Young diagrams (in this article we use the class of, so called, *polynomial functions*) then $\mathcal{F}(\mathbf{p} \times \mathbf{q})$ turns out to be a polynomial in indeterminates $p_1, p_2, \dots, q_1, q_2, \dots$ which will be called *Stanley polynomial*. The Stanley polynomial for the most interesting functions \mathcal{F} , namely for the normalized characters Σ_π , is provided by Stanley-Féray character formula (Theorem 7.22) which was conjectured by Stanley [Sta06] and proved by Féray [Fér08b], for a more elementary proof we refer to [FŚ07].

In the past analysis of some special coefficients of Stanley polynomials resulted in partial results concerning Kerov polynomials [Sta02, Sta03]. In Theorem 7.18 we will show that, in fact, a large class coefficients of Stanley polynomials can be interpreted as coefficients

$$\left. \frac{\partial}{\partial S_{k_1}} \dots \frac{\partial}{\partial S_{k_l}} \mathcal{F} \right|_{S_2=S_3=\dots=0}$$

in the Taylor expansion of \mathcal{F} into the *basic functionals* S_2, S_3, \dots of shape of a Young diagram.

These basic functionals S_2, S_3, \dots of shape are not new; they already appeared (possibly with a slightly modified normalization) in the work of Ivanov and Olshanski [IO02] and implicitly in the work of Kerov [Ker98, Ker99, Ker03].

In this way we are able to express Σ_π as an explicit polynomial in S_2, S_3, \dots . In Proposition 7.16 we will show how to express S_2, S_3, \dots in terms of free cumulants R_2, R_3, \dots . Finally, we use some identities fulfilled by Stanley polynomials (Lemma 7.21) in order to express the coefficients of Kerov polynomials in a useful way.

7.1.8 Combinatorial interpretation of condition (e)

Let (σ_1, σ_2, q) be a triple which fulfills conditions (a)–(d) of Theorem 7.4. We consider the following polyandrous interpretation of Hall marriage theorem. Each cycle of σ_1 will be called a *boy* and each cycle of σ_2 will be called a *girl*. For each girl $j \in C(\sigma_2)$ let $q(j) - 1$ be the *desired number of husbands of j* (notice that condition (c) shows that the number of boys in $C(\sigma_1)$ is right so that if no other restrictions were imposed it would be possible to arrange marriages in such a way that each boy is married to exactly one girl and each girl has the desired number of husbands). We say that a boy $i \in C(\sigma_1)$ is a possible candidate for a husband for a girl $j \in C(\sigma_2)$ if cycles i and j intersect. Hall marriage theorem applied to our setup says that there exists an arrangement of marriages $\mathcal{M} : C(\sigma_1) \rightarrow C(\sigma_2)$ which assigns to each boy his wife (so that each girl j has exactly $q(j) - 1$ husbands) if and only if for every set $A \subseteq C(\sigma_2)$ there are at least $\sum_{i \in A} (q(i) - 1)$ cycles of σ_1 which intersect $\bigcup A$. As one easily see, the above condition is similar but not identical to (e).

Proposition 7.7. *Condition (e) is equivalent to the following one :*

(e²) *for every nontrivial set of girls $A \subset C(\sigma_2)$ (i.e., $A \neq \emptyset$ and $A \neq C(\sigma_2)$) there exist two ways of arranging marriages $\mathcal{M}_p : C(\sigma_1) \rightarrow C(\sigma_2)$, $p \in \{1, 2\}$ for which the corresponding sets of husbands of wives from A are different :*

$$\mathcal{M}_1^{-1}(A) \neq \mathcal{M}_2^{-1}(A).$$

Proof. The implication (e²) \implies (e) is immediate.

For the opposite implication Hall marriage theorem shows existence of \mathcal{M}_1 . Let us select any boy $i \in \mathcal{M}_1^{-1}(A)$ and let us declare that boy i is not allowed to marry any girl from the set A . Applying Hall marriage theorem for the second time shows existence of \mathcal{M}_2 with the required properties which finishes the proof of equivalence. \square

For permutations σ_1, σ_2 it is convenient to introduce a bipartite graph $\mathcal{V}^{\sigma_1, \sigma_2}$ with the set of vertices $C(\sigma_1) \sqcup C(\sigma_2)$ with edges connecting intersecting cycles [FŠ07]. The elements of $C(\sigma_1)$, respectively $C(\sigma_2)$, will be referred to as white, respectively black, vertices. For a bipartite graph with a vertex set V we will denote by V_\bullet the set of black vertices.

The following result gives a strong restriction on the form of the factorizations which contribute to Theorem 7.4 and we hope it will be useful in the future investigations of Kerov polynomials. Notice that this kind of result appears also in the work of Féray [Fér08a].

Proposition 7.8. *Suppose that $\sigma_1, \sigma_2 \in \mathfrak{S}(k)$ are such that in the graph $\mathcal{V}^{\sigma_1, \sigma_2}$ there exists a disconnecting edge e with a property that each of the two connected components of the*

resulting truncated graph $\mathcal{V}^{\sigma_1, \sigma_2} \setminus \{e\}$ contains at least one vertex from $C(\sigma_2)$. Then triple (σ_1, σ_2, q) never contributes to the quantities described in Theorem 7.4 and Theorem 7.6, no matter how q and s_2, s_3, \dots are chosen.

Proof. Before starting the proof notice that the assumptions of Theorem 7.4 and Theorem 7.6 show that in order for (σ_1, σ_2, q) to contribute, graph $\mathcal{V}^{\sigma_1, \sigma_2}$ must be connected.

Let $i \in C(\sigma_1)$, $j \in C(\sigma_2)$ be the endpoints of the edge e and let V_1, V_2 be the connected components of $\mathcal{V}^{\sigma_1, \sigma_2} \setminus \{e\}$; we may assume that $i \in V_1$ and $j \in V_2$. We are going to use the condition (e²). Let A , respectively B , be the set of girls, respectively boys, contained in V_1 . From the assumption it follows that $V_1 \neq \{i\}$ therefore $A \neq \emptyset$; on the other hand $j \in V_2$ therefore $A \neq C(\sigma_2)$.

If

$$|B| - \sum_{j \in A} (q(j) - 1) \quad (112)$$

does not belong to the set $\{0, 1\}$ then it is not possible to arrange the marriages.

If (112) is equal to zero then any arrangement of marriages $\mathcal{M} : C(\sigma_1) \rightarrow C(\sigma_2)$ must fulfill $\mathcal{M}^{-1}(A) = B$; if (112) is equal to 1 then any arrangement of marriages $\mathcal{M} : C(\sigma_1) \rightarrow C(\sigma_2)$ must fulfill $\mathcal{M}^{-1}(A) = B \setminus \{i\}$. In both cases, the set of husbands of wives from A is uniquely determined therefore condition (e²) does not hold. \square

7.1.9 Transportation interpretation of condition (e)

Let G be a bipartite graph and its set of black vertices be V_\bullet . For any set $A \subseteq V_\bullet$ of black vertices we denote by $N_G(A)$ the set of white vertices which have a neighbor in A . We can rephrase condition (e) by :

$$(e^3) \text{ for any non-trivial subset } A, \quad |N_{\mathcal{V}^{\sigma_1, \sigma_2}}(A)| \geq 1 + \sum_{c \in A} [q(c) - 1].$$

Let a coloring $q : V_\bullet \rightarrow \{2, 3, \dots\}$ of the black vertices of a bipartite graph G be given. We say that G is q -admissible if for every set $A \subseteq V_\bullet$ of black vertices $|N_A| \geq \sum_{c \in A} [q(c) - 1]$ and furthermore the equality holds if and only if V_\bullet is equal to the set of all black vertices in a union of some connected components of G .

Notice that if G is connected then it is q -admissible if and only if it satisfies condition (e³).

Proposition 7.9. *Condition (e) is equivalent to the following one :*

(e⁴) *there exists a strictly positive solution to the following system of equations :*

Set of variables

$$\{x_{i,j} : \text{white vertex } i \text{ is connected to black vertex } j\}$$

$$\text{Equations } \begin{cases} \forall i, \sum_j x_{i,j} = 1 \\ \forall j, \sum_i x_{i,j} = q(j) - 1 \end{cases}$$

More generally, graph G is q -admissible if and only if condition (e⁴) is fulfilled.

Before starting the proof note that the possibility of arranging marriages (see Section 7.1.8) can be rephrased as existence of a solution to the above system of equations with a requirement that $x_{i,j} \in \{0, 1\}$.

The system of equations in condition (e⁴) can be interpreted as a transportation problem where each white vertex is interpreted as a factory which produces a unit of some ware and each black vertex j is interpreted as a consumer with a demand equal to $q(j) - 1$. The value of $x_{i,j}$ is interpreted as amount of ware transported from factory i to the consumer j .

Proof. Suppose that the above system has a positive solution. For any $A \subseteq V_\bullet$ we have

$$\sum_{j \in A} (q(j) - 1) = \sum_{j \in A} \sum_{\substack{i: \\ (i,j) \text{ is an edge}}} x_{i,j} = \sum_{i \in N_G(A)} \sum_{\substack{j \in A: \\ (i,j) \text{ is an edge}}} x_{i,j} \leq |N_G(A)|.$$

Furthermore, if $|N_G(A)| = \sum_{j \in A} (q(j) - 1)$ then the above inequality is an equality which means that for each $i \in N_G(A)$ one has

$$\sum_{\substack{j \in A: \\ (i,j) \text{ is an edge}}} x_{i,j} = 1.$$

As $\sum_j x_{i,j} = 1$ and $x_{i,j} > 0$ if (i, j) is an edge, this implies that there is no edge (i, j) with $i \in N_G(A)$ and $j \notin A$. In this way we have proved that A is the set of black vertices of a union of some disjoint components, therefore G is q -admissible.

The opposite implication is easy : we consider the mean of all solutions of the system with the condition $x_{i,j} \in \{0, 1\}$. This gives us a strictly positive solution because the q -admissibility ensures that if we force some variable $x_{i,j}$ to be equal to 1 we can find a solution to the system. □

7.1.10 Open problems

7.1.10.1 C -expansion

In analogy to (109) we define for $k \geq 2$

$$C_k^\lambda = \frac{24}{k(k+1)(k+2)} \lim_{s \rightarrow \infty} \frac{1}{s^k} (\Sigma_{k+1}^{s\lambda} - R_{k+2}^{s\lambda}) \tag{113}$$

which (up to the unusual numerical factor in front) gives the leading terms of the deviation from the first-order approximation $\Sigma_{k+1}^\lambda \approx R_{k+2}^\lambda$. The explicit form of C_k

$$C_k = \sum_{\substack{j_2, j_3, \dots \geq 0, \\ 2j_2 + 3j_3 + \dots = k}} \frac{(j_2 + j_3 + \dots)!}{j_2! j_3! \dots} \prod_{i \geq 2} ((i-1)R_i)^{j_i}$$

as a polynomial in free cumulants R_2, R_3, \dots was conjectured by Biane [Bia03] and was proved by Śniady [Śni06a]. Goulden and Rattan [GR07] proved that for each $k \geq 1$ there exists a universal polynomial L_k called *Goulden–Rattan polynomial* with rational coefficients such that

$$\Sigma_k - R_{k+1} = L_k(C_2, C_3, \dots) \tag{114}$$

and they found an explicit but complicated formula for L_k . A simpler proof and some more related results can be found in the work of Biane [Bia07].

Conjecture 7.10 (Goulden and Rattan [GR07]). *The coefficients of L_k are non-negative rational numbers with relatively small denominators.*

It is natural to conjecture that the underlying reason for positivity of the coefficients is that they have (after some additional rescaling) a combinatorial interpretation.

In some sense the free cumulants (R_k) are analogous to the above quantities (C_k) : both have natural interpretations as leading (respectively, subleading) terms in the asymptotics of characters, cf. (109), respectively (113). Also, Conjecture 7.1 is analogous to Conjecture 7.10: both conjectures state that there are exact formulas which express the characters Σ_k (respectively, the subdominant terms of the characters $\Sigma_k - R_{k+1}$) as polynomials in free cumulants (respectively, $(C_k)_{k \geq 2}$) with non-negative integer coefficients (respectively, non-negative rational coefficients with small denominators) which have a combinatorial interpretation.

The advantage of the quantities (C_k) over free cumulants (R_k) is that the Goulden–Rattan polynomials L_k seem to have a simpler form than Kerov polynomials K_k while the numerical evidence for Conjecture 7.10 suggests that their coefficients should have a rich and beautiful structure. Also, Kerov’s conjecture (Conjecture 7.1) would be an immediate corollary from Conjecture 7.10. For these reasons we tend to believe that the quantities (C_k) are even better suitable for the asymptotic representation theory than the free cumulants (R_k) and Conjecture 7.10 deserves serious interest.

7.1.10.2 \mathcal{R} -expansion

Another interesting direction of research was pointed out by Lassalle [Las08d] who presented quite explicit conjectures on the form of the coefficients of Kerov polynomials.

7.1.10.3 Arithmetic properties of Kerov polynomials

Proposition 7.11. *If p is an odd prime number then $\frac{\Sigma_p - R_{p+1} + 2R_2}{p}$ and $\frac{\Sigma_{p-1} - R_p}{p}$ are polynomials in free cumulants R_2, R_3, \dots with nonnegative integer coefficients.*

Proof. In order to prove that the coefficients of $\frac{\Sigma_p - R_{p+1} + 2R_2}{p}$ are integer we consider the action of the group $\mathbb{Z}/p\mathbb{Z}$ on the set of triples (σ_1, σ_2, q) which contribute to Theorem 7.4 defined by conjugation

$$\psi(i)(\sigma_1, \sigma_2, q) = (c^i \sigma_1 c^{-i}, c^i \sigma_2 c^{-i}, q'),$$

where $c = (1, 2, \dots, k)$ is the cycle; we leave the details how to define q' as a simple exercise. All orbits of this action consist of p elements except for the fixpoints of this action which are of the form $\sigma_1 = c^a, \sigma_2 = c^{1-a}$. These fixpoints contribute to the monomial R_{k+1} (with multiplicity 1) and to the monomial R_2 (with multiplicity $p - 2$).

In order to prove that the coefficients of $\frac{\Sigma_{p-1} - R_p}{p}$ are integer we express R_p as a linear combination of the conjugacy classes Σ_π . A formula for such an expansion presented in the paper [Šni06a] involves summation over all partitions of the set $\{1, \dots, p\}$. The group $\mathbb{Z}/p\mathbb{Z}$ acts on such partitions; all orbits in this action consist of p elements except for the fixpoints of this action: the minimal partition (which gives Σ_{p-1}) and the maximal partition (which turns out not to contribute). We express all summands (except for the summand corresponding to Σ_{p-1}) as polynomials in free cumulants, which finishes the proof. \square

The following conjecture was formulated by Światosław Gal (private communication) based on numerical calculations.

Conjecture 7.12. *If p is an odd prime number then and $\frac{\Sigma_{p+1}-R_{p+2}+R_3}{p}$ is a polynomial in free cumulants R_2, R_3, \dots with nonnegative integer coefficients.*

We hope that the above claims will shed some light on more precise structure of Kerov polynomials and on the form of C -expansion and \mathcal{R} -expansion described above; they suggest that (maybe up to some small error terms) $\Sigma_n - R_{n+1}$ should in some sense be divisible by $(n-1)n(n+1)$ which supports the conjectures of Lassalle [Las08d].

7.1.10.4 Discrete version of the functionals S_2, S_3, \dots

One of the fundamental ideas in this paper is the use of the fundamental functionals S_2, S_3, \dots of the shape of a Young diagram defined as integrals over the area of a Young diagram of the powers of the contents :

$$S_n^\lambda = (n-1) \iint_{\square \in \lambda} (\text{contents}_\square)^{n-2} d\square \quad (115)$$

(we postpone the precise definition until Section 7.3.2).

It would be interesting to investigate properties of analogous quantities

$$T_n^\lambda = (n-1) \sum_{\square \in \lambda} (\text{contents}_\square)^{n-2} \quad (116)$$

in which the integral over the Young diagram was replaced by a sum over its boxes. Notice that unlike the integrals (115) which are well-defined for generalized Young diagrams, the sum (116) makes sense only if λ is a conventional Young diagram but since the resulting object is a polynomial function on the set of Young diagrams it can be extended to generalized Young diagrams. This type of quantities have been investigated by Corteel, Goupil and Schaeffer [CGS04].

The reason why we find the functional T_n so interesting is that via non-commutative Fourier transform it corresponds to a central element of the symmetric group algebra $\mathbb{C}[\mathfrak{S}(k)]$ given by the following very simple formula

$$T_n = (n-1) \sum_{2 \leq i \leq n} X_i^{n-2},$$

where

$$X_i = (1, i) + (2, i) + \dots + (i-1, i) \in \mathbb{C}[\mathfrak{S}(k)]$$

are the Jucys-Murphy elements.

The hidden underlying idea behind the current paper is the differential calculus on the (polynomial) functions on the set of generalized Young diagrams \mathcal{Y} in which we study derivatives corresponding to infinitesimal changes of the shape of a Young diagram, as it can be seen in the proof of Theorem 7.18. It is possible to develop the formalism of such a differential calculus and to express the results of this paper in such a language instead of the language

of Stanley polynomials (and, in fact, the initial version of this article was formulated in this way), nevertheless if the main goal is to prove the Kerov conjecture then this would lead to unnecessary complication of the paper.

On the other hand, just like the usual differential and integral calculus has an interesting discrete difference and sum analogue, the above described differential calculus on generalized Young diagrams has a discrete difference analogue in which we study the change of the function on the set of Young diagrams corresponding to addition or removal of a single box. We expect that just like functionals (S_n) are so useful in the framework of differential calculus on the set of generalized Young diagrams, functionals (T_n) will be useful in the framework of the difference calculus on Young diagrams.

It would be very interesting to develop such a difference calculus and to verify if free cumulants (R_n) have some interesting discrete version which nicely fits into this setup.

7.1.10.5 Characterization of Stanley polynomials

Lemma 7.21 contains some identities fulfilled by Stanley polynomials. It would be interesting to find some more such identities. In particular we state the following problem here.

Problem 7.13. *Find (minimal set of) conditions which fully characterize the class of Stanley polynomials $\mathcal{F}(\mathbf{p} \times \mathbf{q})$ where \mathcal{F} is a polynomial function on the set of Young diagrams.*

It seems plausible that the answer for this problem is best formulated in the language of the differential calculus of function on the set of generalized Young diagrams about which we mentioned in Section 7.1.10.4.

If we write a polynomial \mathcal{F} in p and q in terms of Kerov's interlacing coordinates $(x_i$ and y_j , which depend linearly on p and q , see paragraph 2.2.3), then the characterization of Stanley polynomials is known (the author of this thesis thanks G. Olshanski for this remark). Indeed they are exactly the supersymmetric functions [KO94], which has been characterized by J.R. Stembridge [Ste85]. But it does not seem easy to translate this characterization on the coefficients as a polynomial in p and q .

7.1.10.6 Various open problems

Is there some analogue of Kerov character polynomials for the representation theory of semisimple Lie groups, in particular for the unitary groups $U(d)$? Does existence of Kerov polynomials for characters of symmetric groups $\mathfrak{S}(n)$ tell us something (for example via Schur-Weyl duality) about representations of the unitary groups $U(d)$? Is there some analogue of Kerov character polynomials in the random matrix theory? Is it possible to study Kerov polynomials in such a scaling that phenomena of universality of random matrices occur?

7.1.11 Exotic interpretations of Kerov polynomials

Theorem 7.4 gives some interpretation of the coefficients of Kerov polynomials but clearly it does not mean that there are no other interpretations.

7.1.11.1 Biane's decomposition

The original conjecture of Biane [Bia03] suggested that the coefficients of Kerov polynomials are equal to multiplicities in some unspecified decomposition of the Cayley graph of the symmetric group into a signed sum of non-crossing partitions. This result was proved by Féray [Fér08a] but the details of his construction were quite implicit. In Section 7.8 we shall revisit the conjecture of Biane in the light of our new combinatorial interpretation of Kerov polynomials. Unfortunately, our understanding of this interpretation of the coefficients of Kerov polynomials is still not satisfactory and remains as an open problem.

7.1.11.2 Multirectangular random matrices

For a given Young diagram λ we consider a Gaussian random matrix (A_{ij}^λ) with the shape of λ . Formally speaking, the entries of (A_{ij}^λ) are independent with $A_{ij}^\lambda = 0$ if box (i, j) does not belong to λ ; otherwise $\Re A_{ij}^\lambda, \Im A_{ij}^\lambda$ are independent Gaussian random variables with mean zero and variance $\frac{1}{2}$. One can think that either (A_{ij}^λ) is an infinite matrix or it is a square (or rectangular) matrix of sufficiently big size.

Theorem 7.14. *Kerov polynomials express the moments of the random matrix A^λ in terms of the genus-zero terms in the genus expansion (up to the sign). More precisely,*

$$\mathbb{E} [\text{Tr} (A^\lambda (A^\lambda)^*)^n] = K_n(-R_2, R_3, -R_4, R_5, \dots),$$

where R_i is defined as the genus zero term in the expansion for

$$\mathbb{E} \left[\text{Tr} \left(A^\lambda (A^\lambda)^* \right)^{i-1} \right],$$

or, precisely speaking,

$$R_i = \lim_{s \rightarrow \infty} \frac{1}{s^i} \mathbb{E} \left[\text{Tr} \left(A^{s\lambda} (A^{s\lambda})^* \right)^{i-1} \right].$$

This is an immediate consequence of the results from [FŚ07].

7.1.11.3 Dimensions of (co)homologies

In analogy to Kazhdan-Lusztig polynomials it is tempting to ask if the coefficients of Kerov polynomials might have a topological interpretation, for example as dimensions of (co)homologies of some interesting geometric objects, maybe related to Schubert varieties, as suggested by Biane (private communication). This would be supported by the Biane's decomposition from Section 7.1.11.1 which maybe is related to Bruhat order and Schubert cells. In this context it is interesting to ask if the conditions from Theorem 7.4 can be interpreted as geometric conditions on intersections of some geometric objects. Another approach towards establishing link between Kerov polynomials and Schubert calculus would be to relate Kerov polynomials and Schur symmetric polynomials.

7.1.11.4 Schur polynomials

Each Schur polynomial can be written as quotient of two determinants. Exactly the same quotient of determinants appears in the Harish-Chandra-Itzykson-Zuber integral

$$\int_{U(d)} e^{AUBU^*} dU$$

if A and B are hermitian matrices with suitably chosen eigenvalues (say (x_i) for A and $(\log \lambda_i)$ for B).

It would be interesting to verify if Kerov polynomials can be used to express the exact values of Schur polynomials by some limit value of Harish-Chandra-Itzykson-Zuber integral when the size of the matrix tends to infinity and each variable x_i occurs with a multiplicity which tends to infinity; also the shape of the Young diagram λ should tend to infinity, probably in the “balanced Young diagram” way.

7.1.11.5 Analytic maps

We conjecture that Kerov polynomials are related to moduli space of analytic maps on Riemann surfaces or ramified coverings of a sphere.

7.1.11.6 Integrable hierarchy

Jonathan Novak (private communication) conjectured that Kerov polynomials might be algebraic solutions to some integrable hierarchy (maybe Toda?) and their coefficients are related to the tau function of the hierarchy.

7.1.12 Applications of the main result

7.1.12.1 Positivity conjectures and precise information on Kerov polynomials

The advantage of the approach to characters of symmetric groups presented in this article over some other methods is that the formula for the coefficients given by Theorem 7.4 does not involve summation of terms of positive and negative sign unlike most formulas for characters such as Murnaghan-Nakayama rule or Stanley-Féray formula (Theorem 7.22). In this way we avoid dealing with complicated cancellations. For this reason the main result of the current paper seems to be a perfect tool for proving stronger results, such as the Conjecture 7.10 of Goulden and Rattan or the conjectures of Lassalle [Las08d].

7.1.12.2 Genus expansion

One of the important methods in the random matrix theory and in the representation theory is to express the quantity we are interested in (for example : moment of a random matrix or character of a representation) as a sum indexed by some combinatorial objects (for example : partitions of an ordered set or maps) to which one can associate canonically a two-dimensional surface [LZ04]. Usually the asymptotic contribution of such a summand depends on the topology of the surface with planar objects being asymptotically dominant.

This method is called genus expansion since exponent describing the rate of decay of a given term usually linearly depends on the genus.

The main result of this article fits perfectly into this philosophy since to any pair of permutations σ_1, σ_2 which contributes to Theorem 7.4 or Theorem 7.6 we may associate a canonical graph on a surface, called a *map*. It is not difficult to show that also in this situation the degree of the terms $R_2^{s_2} R_3^{s_3} \cdots$ to which such a pair of permutations contributes decreases as the genus increases.

It is natural therefore to ask about the structure of factorizations $\sigma_1 \circ \sigma_2 = (1, 2, \dots, k)$ with a prescribed genus. As we already pointed out in Proposition 7.8, condition (e) of Theorem 7.4 gives strong limitations on the shape of the resulting bipartite graph $\mathcal{V}^{\sigma_1, \sigma_2}$ which translate to limitations on the shape of the corresponding map. Very analogous situation was analyzed in the paper [Śni06a] where it was proved that by combining a restriction on the genus and a condition analogous to the one from Proposition 7.8 (“*evercrossing partitions*”) one gets only a finite number of allowed patterns for the geometric object concerned.

Similar analysis should be possible for the formulas for Kerov polynomials presented in the current paper which should shed some light on Conjecture 7.10 of Goulden and Rattan and the conjectures of Lassalle [Las08d].

7.1.12.3 Upper bounds on characters

It seems plausible that the main result of this article, Theorem 7.4 and Theorem 7.6, can be used to prove new upper bounds on the characters of symmetric groups

$$\chi^\lambda(\pi) = \frac{\text{Tr } \rho^\lambda(\pi)}{\text{dimension of } \rho^\lambda} \quad (117)$$

for balanced Young diagram λ in the scaling when the length of the permutation π is large compared to the number of boxes of λ .

The advantage of such approach to estimates on characters over other methods, such as via Frobenius formula as in the work of Rattan and Śniady [RŚ08] or via Stanley-Féray formula [FŚ07], becomes particularly visible in the case when the shape of the Young diagram becomes close to the limit curve for the Plancherel measure [LS77, VK77] for which all free cumulants (except for R_2) are close to zero. Indeed, for λ in the neighborhood of this limit curve one should expect much tighter bounds on the characters (117) because such Young diagrams maximize the dimension of the representation which is the denominator of the fraction, while the numerator can be estimated by Murnaghan-Nakayama rule and some combinatorial tricks [Roi96].

7.1.13 Overview of the paper

In Section 7.2 we recall some basic facts about free cumulants R_1, R_2, \dots and quantities S_1, S_2, \dots for probability measures on the real line and their relations with each other. The main result of this section is formula (122) which allows to express functionals S_1, S_2, \dots in terms of free cumulants R_1, R_2, \dots .

In Section 7.3 we define the fundamental functionals S_2, S_3, \dots for generalized Young diagrams and study their geometric interpretation.

In Section 7.4 we study Stanley polynomials and their relations to the fundamental functionals S_2, S_3, \dots of shape of a Young diagram.

Section 7.5 is devoted to a toy example : we shall prove Theorem 7.4 in the simplest non-trivial case of coefficients of the quadratic terms, which is exactly the case in Theorem 7.3. In this way the Reader can see all essential steps of the proof in a simplified situation when it is possible to avoid technical difficulties.

In Section 7.6 we prove some auxiliary combinatorial results.

In Section 7.7 we present the proof of the main result : Theorem 7.4 and Theorem 7.6.

Finally, in Section 7.8 we revisit the paper [Fér08a] and we show how rather implicit constructions of Féray become much more concrete once one knows the formulation of the main result of the current paper, Theorem 7.4. In fact, Section 7.8 provides an alternative proof of Theorem 7.4 based on the results of Féray.

7.2 Functionals of measures

In this section we present relations between moments M_1, M_2, \dots of a given probability measure, its free cumulants R_1, R_2, \dots and its functionals S_1, S_2, \dots . The only result of this section which will be used in the remaining part of the article is equality (122), nevertheless we find functionals S_1, S_2, \dots so important that we collected in this section also some other formulas involving them.

Assume that ν is a compactly supported measure on \mathbb{R} . For integer $n \geq 0$ we consider moments of ν

$$M_n^\nu = \int z^n d\nu(z)$$

and its Cauchy transform

$$G^\nu(z) = \int \frac{1}{z-x} d\nu(x) = \sum_{n \geq 0} \frac{M_n^\nu}{z^{1+n}};$$

the integral and the series make sense in a neighborhood of infinity.

From the following on we assume that ν is a compactly supported probability measure on \mathbb{R} . We define a sequence $(S_n^\nu)_{n \geq 1}$ of the coefficients of the expansion

$$S^\nu(z) = \log z G^\nu(z) = \sum_{n \geq 1} \frac{S_n^\nu}{z^n}$$

in a neighborhood of infinity and a sequence $(R_n^\nu)_{n \geq 1}$ of free cumulants as the coefficients of the expansion

$$R^\nu(z) = (G^\nu)^{(-1)}(z) - \frac{1}{z} = \sum_{n \geq 1} R_n^\nu z^{n-1} \quad (118)$$

in a neighborhood of 0, where $(G^\nu)^{(-1)}$ is the right inverse of G^ν with respect to the composition of functions [Voi86]. When it does not lead to confusions we shall omit the superscript in the expressions $M_n^\nu, G^\nu, S^\nu, R^\nu, S_n^\nu, R_n^\nu$.

The relation between the moments and the free cumulants is given by the following combinatorial formula which, in fact, can be regarded as an alternative definition of free cumulants [Spe98] :

$$M_n = \sum_{\Pi \in \text{NC}_n} R_{\Pi}, \quad (119)$$

where the summation is carried over all non-crossing partitions of n -element set and where R_{Π} is defined as the multiplicative extension of (R_k) :

$$R_{\Pi} = \prod_{b \in \Pi} R_{|b|},$$

where the product is taken over all blocks b of the partition Π and $|b|$ denotes the number of the elements in b [Spe98].

Information about the measure ν can be described in various ways; in this article descriptions in terms of the sequences (S_n) and (R_n) play eminent role and we need to be able to relate each of these sequences to the other. We shall do it in the following.

Lemma 7.15. *For any integer $k \geq 1$*

$$\frac{\partial G(R_1, R_2, \dots)}{\partial R_k}(z) = -\frac{1}{k} \left([G(z)]^k \right)' = -G^{k-1}(z)G'(z),$$

where both sides of the above equality are regarded as formal power series in powers of $\frac{1}{z}$ with the coefficients being polynomials in R_1, R_2, \dots .

Proof. Equation (118) is equivalent to

$$G \left(R(z) + \frac{1}{z} \right) = z. \quad (120)$$

We denote

$$t = R(z) + \frac{1}{z}.$$

Let us keep all free cumulants fixed except for R_k , we shall treat G as a function of free cumulants. By taking the derivatives of both sides of (120) it follows that

$$\begin{aligned} 0 &= \frac{\partial}{\partial R_k} \left[G \left(R(z) + \frac{1}{z} \right) \right] = \frac{\partial G}{\partial R_k}(t) + G'(t) \frac{\partial}{\partial R_k} \left(R(z) + \frac{1}{z} \right) = \\ & \frac{\partial G}{\partial R_k}(t) + G'(t) z^{k-1} = \frac{\partial G}{\partial R_k}(t) + G'(t) \cdot G^{k-1}(t) \end{aligned}$$

which finishes the proof. \square

Proposition 7.16. *For any integer $n \geq 1$, one has :*

$$M_n = \sum_{l \geq 1} \frac{1}{l!} (n)_{l-1} \sum_{\substack{k_1, \dots, k_l \geq 1 \\ k_1 + \dots + k_l = n}} R_{k_1} \cdots R_{k_l}, \tag{121}$$

$$S_n = \sum_{l \geq 1} \frac{1}{l!} (n-1)_{l-1} \sum_{\substack{k_1, \dots, k_l \geq 1 \\ k_1 + \dots + k_l = n}} R_{k_1} \cdots R_{k_l}, \tag{122}$$

$$R_n = \sum_{l \geq 1} \frac{1}{l!} (-n+1)^{l-1} \sum_{\substack{k_1, \dots, k_l \geq 1 \\ k_1 + \dots + k_l = n}} S_{k_1} \cdots S_{k_l}, \tag{123}$$

where

$$(a)_b = \underbrace{a(a-1) \cdots (a-b+1)}_{b \text{ factors}}$$

denotes the falling factorial.

Proof. Lemma 7.15 shows that

$$\frac{\partial^2 G(R_1, R_2, \dots)}{\partial R_k \partial R_l}(z) = \frac{1}{k+l-1} \left([G(z)]^{k+l-1} \right)''$$

therefore if $k+l = k'+l'$ then

$$\frac{\partial^2 M_n(R_1, R_2, \dots)}{\partial R_k \partial R_l} = \frac{\partial^2 M_n(R_1, R_2, \dots)}{\partial R_{k'} \partial R_{l'}}.$$

It follows by induction that

$$\frac{\partial^l M_n(R_1, R_2, \dots)}{\partial R_{k_1} \cdots \partial R_{k_l}} = \frac{\partial^l M_n(R_1, R_2, \dots)}{(\partial R_1)^{l-1} \partial R_{k_1 + \dots + k_{l-(l-1)}}}.$$

From the moment-cumulant formula (119) it follows that for $R_1 = R_2 = \dots = 0$ the right-hand side of the above equation is equal to the number of non-crossing partitions with an ordering of blocks, such that the numbers of elements in consecutive blocks are as follows :

$$\underbrace{1, \dots, 1}_{l-1 \text{ times}}, k_1 + \dots + k_l - (l-1).$$

Such non-crossing partitions have a particularly simple structure therefore it is very easy to find their cardinality. Therefore

$$\left. \frac{\partial^l M_n(R_1, R_2, \dots)}{(\partial R_1)^{l-1} \partial R_{k_1 + \dots + k_{l-(l-1)}}} \right|_{R_1=R_2=\dots=0} = \begin{cases} (n)_{l-1} & \text{if } n = k_1 + \dots + k_l, \\ 0 & \text{otherwise,} \end{cases} \tag{124}$$

which finishes the proof of (121).

Lemma 7.15 shows that for $k \geq 2$

$$\frac{\partial S(R_1, R_2, \dots)}{\partial R_k}(z) = \frac{\partial \log [zG(z)]}{\partial R_k} = -G^{k-2}G' = \frac{\partial G(R_1, R_2, \dots)}{\partial R_{k-1}}$$

therefore

$$\frac{\partial S_n(R_1, R_2, \dots)}{\partial R_k} = \frac{\partial M_{n-1}(R_1, R_2, \dots)}{\partial R_{k-1}}.$$

Assume that $k_l \geq 2$; then

$$\frac{\partial^l S_n(R_1, R_2, \dots)}{\partial R_{k_1} \cdots \partial R_{k_l}} = \frac{\partial^l M_{n-1}(R_1, R_2, \dots)}{\partial R_{k_1} \cdots \partial R_{k_l-1}}$$

which is calculated in Eq. (124). In this way we proved that if $(k_1, \dots, k_l) \neq (1, 1, \dots, 1)$ then

$$\left. \frac{\partial^l S_n(R_1, R_2, \dots)}{\partial R_{k_1} \cdots \partial R_{k_l}} \right|_{R_1=R_2=\dots=0} = \begin{cases} (n-1)_{l-1} & \text{if } n = k_1 + \dots + k_l, \\ 0 & \text{otherwise.} \end{cases}$$

In order to prove the case $k_1 = \dots = k_l = 1$ it is enough to consider the Dirac point measure $\nu = \delta_a$ for which $G(z) = \frac{1}{z-a}$, $R_1 = a$, $R_2 = R_3 = \dots = 0$ and $S(z) = -\log(1 - \frac{a}{z})$, $S_n = \frac{a^n}{n}$. In this way the proof of (122) is finished.

Lagrange inversion formula shows that

$$R_{n+1} = -\frac{1}{n} \left[\frac{1}{z} \right] \left(\frac{1}{G(z)} \right)^n = -\frac{1}{n} \left[\frac{1}{z^{n+1}} \right] \exp[-nS(z)] = \sum_{l \geq 1} \frac{1}{l!} (-n)^{l-1} \sum_{\substack{k_1, \dots, k_l \geq 1 \\ k_1 + \dots + k_l = n+1}} S_{k_1} \cdots S_{k_l}$$

which finishes the proof of (123). □

7.3 Generalized Young diagrams

The main result of this section is the formula (125) which relates the fundamental functionals S_2, S_3, \dots to the geometric shape of the Young diagram.

In the following we base on the notations introduced in Section 7.1.1.

7.3.1 Measure on a diagram and contents of a box

Notice that each unit box of a Young diagram drawn in the French convention becomes in the Russian notation a square of side $\sqrt{2}$. For this reason, when drawing a Young diagram according to the French convention we will use the plane equipped with the usual measure (i.e. the area of a unit square is equal to 1) and when drawing a Young diagram according to the Russian notation we will use the plane equipped with the usual measure divided by 2 (i.e. the area of a unit square is equal to $\frac{1}{2}$). In this way a (generalized) Young diagram has the same area when drawn in the French and in the Russian convention.

Speaking very informally, the setup of generalized Young diagrams corresponds to looking at a Young diagram from very far away so that individual boxes become very small. Therefore by the term *box of a Young diagram* λ we will understand simply any point \square which belongs to λ . In the case of the Russian convention this means that $\square = (x, y)$ fulfills

$$|x| < y < \lambda(x).$$

We define the contents of the box $\square = (x, y)$ in the Russian convention by $\text{contents}_{\square} = x$.

In the case of the French convention $\square = (x, y)$ belongs to a diagram λ if

$$x > 0 \quad \text{and} \quad 0 < y < \lambda(x)$$

and the contents of the box $\square = (x, y)$ is defined by $\text{contents}_{\square} = x - y$.

7.3.2 Functionals of Young diagrams

The above definitions of the measure on the plane and of the contents in the case of French and Russian conventions are compatible with each other, therefore it is possible to define some quantities in a convention-independent way. In particular, we define the *fundamental functionals of shape* of a generalized Young diagram

$$S_n^\lambda = (n-1) \iint_{\square \in \lambda} (\text{contents}_{\square})^{n-2} d\square \quad (125)$$

for integer $n \geq 2$. Clearly, each functional S_n is a homogeneous function of the Young diagram with degree n .

Let a generalized Young diagram $\lambda : \mathbb{R} \rightarrow \mathbb{R}_+$ drawn in the Russian convention be fixed. We associate to it a function

$$\tau^\lambda(x) = \frac{\lambda(x) - |x|}{2}$$

which gives the distribution of the contents of the boxes of λ . When it does not lead to confusions we will write for simplicity τ instead of τ^λ . In the following we shall view τ as a measure on \mathbb{R} . Its Cauchy transform can be written as

$$G^\tau(z) = \iint_{\square \in \lambda} \frac{1}{z - \text{contents}_{\square}} d\square.$$

With these notations we have that

$$S_n^\lambda = (n-1) \int x^{n-2} d\tau(x) = - \int x^{n-1} d\tau'(x)$$

are (rescaled) moments of the measure τ or, alternatively, (shifted) moments of the Schwartz distribution $-\tau'$.

We define

$$S^\lambda(z) = \sum_{n \geq 2} \frac{S_n^\lambda}{z^n} = \iint_{\lambda \in \square} \frac{1}{(z - \text{contents}_{\square})^2} d\square$$

where the second equality follows by expanding right-hand side into a power series and (125). It follows that

$$S^\lambda(z) = -\frac{d}{dz} G^\tau(z) = G^{-\tau'}(z) = - \int \frac{1}{z-x} \tau'(x) dx = - \int \log(z-x) \tau''(x) dx,$$

in particular $S^\lambda(z)$ coincides with the Cauchy transform of a Schwartz distribution $-\tau'$. The above formulas show that $S^\lambda(z)$ and $S_n^\lambda(z)$ coincide (up to small modifications) with the quantities considered by Kerov [Ker99, Ker03], Ivanov and Olshanski [IO02].

7.3.3 Kerov transition measure

The corresponding Cauchy transform

$$G^\lambda(z) = \frac{1}{z} \exp S^\lambda(z) \quad (126)$$

is a Cauchy transform of a probability measure μ_λ on the real line, called *Kerov transition measure* of λ [Ker99, Ker03]. Probably it would be more correct to write G^{μ_λ} instead of G^λ and to write S^{μ_λ} instead of S^λ , but this would lead to unnecessary complexity of the notation.

One of the reasons why Kerov's transition measure was so successful in the asymptotic representation theory of symmetric groups is that it can be defined in several equivalent ways, related either to the shape of λ or to representation theory or to moments of Jucys-Murphy elements or to certain matrices. For a review of these approaches we refer to [Bia98].

7.3.4 Free cumulants of a Young diagram

In order to keep the introduction as non-technical as possible, we introduced free cumulants of a Young diagram by the formula (109). The conventional way of defining them is to use (118) for the Cauchy transform given by (126). Therefore, one should make sure that these two definitions are equivalent. This can be done thanks to Frobenius formula

$$\Sigma_{k-1}^\lambda = -\frac{1}{k-1} \left[\frac{1}{z} \right] \frac{1}{G^\lambda(z-1)G^\lambda(z-2)\cdots G^\lambda(z-(k-1))}$$

which shows that

$$\frac{1}{s^k} \Sigma_{k-1}^{s\lambda} = -\frac{1}{k-1} \left[\frac{1}{z} \right] \frac{1}{G^\lambda(z-\frac{1}{s})G^\lambda(z-\frac{2}{s})\cdots G^\lambda(z-\frac{k-1}{s})};$$

therefore definition (109) would give

$$R_k^\lambda = -\frac{1}{k-1} \left[\frac{1}{z} \right] \left(\frac{1}{G^\lambda(z)} \right)^{k-1}$$

which coincides with the value given by the Lagrange inversion formula applied to (118).

7.3.5 Polynomial functions on the set of Young diagrams

For simplicity we shall often drop the explicit dependence of the functionals of Young diagrams from λ . Since the transition measure μ^λ is always centered it follows that $M_1 = R_1 = S_1 = 0$.

Existence of Kerov polynomials allows us define formally the normalized characters Σ_π^λ even if λ is a generalized Young diagram.

We will say that a function on the set of generalized Young diagrams \mathcal{Y} is a *polynomial function* if one of the following equivalent conditions hold [IO02] :

- it is a polynomial in M_2, M_3, \dots ;
- it is a polynomial in S_2, S_3, \dots ;
- it is a polynomial in R_2, R_3, \dots ;
- it is a linear combination of $(\Sigma_\pi)_\pi$.

7.4 Stanley polynomials and Stanley-Féray character formula

7.4.1 Stanley polynomials

Proposition 7.17. *Let $\mathcal{F} : \mathcal{Y} \rightarrow \mathbb{R}$ be a polynomial function on the set of generalized Young diagrams. Then $(\mathbf{p}, \mathbf{q}) \mapsto \mathcal{F}(\mathbf{p} \times \mathbf{q})$ for $\mathbf{p} = (p_1, \dots, p_m)$, $\mathbf{q} = (q_1, \dots, q_m)$ is a polynomial in indeterminates $p_1, \dots, p_m, q_1, \dots, q_m$, called Stanley polynomial.*

Proof. It is enough to prove this proposition for some family of generators of the algebra of polynomial functions on \mathcal{Y} for example for functionals S_2, S_3, \dots . We leave it as an exercise. \square

Theorem 7.18. *Let $\mathcal{F} : \mathcal{Y} \rightarrow \mathbb{R}$ be a polynomial function on the set of generalized Young diagrams, we shall view it as a polynomial in S_2, S_3, \dots . Then for any $k_1, \dots, k_l \geq 2$*

$$\frac{\partial}{\partial S_{k_1}} \cdots \frac{\partial}{\partial S_{k_l}} \mathcal{F} \Big|_{S_2=S_3=\dots=0} = [p_1 q_1^{k_1-1} \cdots p_l q_l^{k_l-1}] \mathcal{F}(\mathbf{p} \times \mathbf{q}). \quad (127)$$

Proof. Let $\mathbf{p} = (p_1, \dots, p_m)$, $\mathbf{q} = (q_1, \dots, q_m)$. For a given index i we consider a trajectory in the set of generalized Young diagrams $q_i \mapsto (\mathbf{p} \times \mathbf{q})$, where all other parameters (p_j) and $(q_j)_{j \neq i}$ are treated as constants. In the Russian convention we have

$$\left(\frac{\partial}{\partial q_i} (\mathbf{p} \times \mathbf{q}) \right) (x) = \begin{cases} 2 & \text{if } q_i - p_1 - \cdots - p_i < x < q_i - p_1 - \cdots - p_{i-1}, \\ 0 & \text{otherwise,} \end{cases}$$

which shows the change of the contents distribution. From (125) it follows therefore

$$\frac{\partial}{\partial q_i} S_n^{\mathbf{p} \times \mathbf{q}} = \int_{q_i - p_1 - \cdots - p_i}^{q_i - p_1 - \cdots - p_{i-1}} (n-1)x^{n-2} dx$$

and

$$\frac{\partial}{\partial q_i} \mathcal{F}(\mathbf{p} \times \mathbf{q}) = \sum_{n \geq 2} \int_{q_i - p_1 - \cdots - p_i}^{q_i - p_1 - \cdots - p_{i-1}} \frac{\partial \mathcal{F}}{\partial S_n} (n-1)x^{n-2} dx.$$

By iterating the above argument we show that

$$\begin{aligned} \frac{\partial}{\partial q_1} \cdots \frac{\partial}{\partial q_l} \mathcal{F}(\mathbf{p} \times \mathbf{q}) &= \sum_{n_1, \dots, n_l \geq 2} \frac{\partial}{\partial S_{n_1}} \cdots \frac{\partial}{\partial S_{n_l}} \mathcal{F}(\mathbf{p} \times \mathbf{q}) \times \\ &\quad \int_{q_1 - p_1}^{q_1} (n_1 - 1)x_1^{n_1-2} dx_1 \cdots \int_{q_l - p_1 - \cdots - p_l}^{q_l - p_1 - \cdots - p_{l-1}} (n_l - 1)x_l^{n_l-2} dx_l. \end{aligned}$$

We shall treat both sides of the above equality as polynomials in \mathbf{p} and we will treat \mathbf{q} as constants. We are going to compute the coefficient of $p_1 \cdots p_m$ of both sides; we do this by computing the dominant term of the right-hand side in the limit $\mathbf{p} \rightarrow 0$. It follows that

$$\begin{aligned} [p_1 \cdots p_m] \frac{\partial}{\partial q_1} \cdots \frac{\partial}{\partial q_l} \mathcal{F}(\mathbf{p} \times \mathbf{q}) &= \\ &\quad \sum_{n_1, \dots, n_l \geq 2} \frac{\partial}{\partial S_{n_1}} \cdots \frac{\partial}{\partial S_{n_l}} \mathcal{F}(\mathbf{p} \times \mathbf{q}) \Big|_{p_1=\dots=p_l=0} \times (n_1 - 1)q_1^{n_1-2} \cdots (n_l - 1)q_l^{n_l-2} \end{aligned}$$

which finishes the proof. \square

Corollary 7.19. *If $k_1, \dots, k_l \geq 2$ then*

$$[p_1 q_1^{k_1-1} \cdots p_l q_l^{k_l-1}] \mathcal{F}(\mathbf{p} \times \mathbf{q})$$

does not depend on the order of the elements of the sequence (k_1, \dots, k_l) .

7.4.2 Identities fulfilled by coefficients of Stanley polynomials

The coefficients of Stanley polynomials of the form $[p_1 q_1^{k_1-1} \cdots p_l q_l^{k_l-1}] \mathcal{F}(\mathbf{p} \times \mathbf{q})$ with $q_1, \dots, q_{k_l} \geq 2$ have a relatively simple structure, as it can be seen for example in Corollary 7.19. In the following we will study the properties of such coefficients if some of the numbers q_1, \dots, q_{k_l} are equal to 1.

Let $\mathcal{F} : \mathcal{Y} \rightarrow \mathbb{R}$ be a fixed polynomial function. For a sequence $(a_1, b_1), \dots, (a_m, b_m)$ of ordered pairs, where $a_1, \dots, a_m \geq 2$ and $b_1, \dots, b_m \geq 1$ are integers we define an auxiliary quantity

$$Q_{(a_1, b_1), \dots, (a_m, b_m)}^{\mathcal{F}} = \left(\prod_r (-1)^{b_r-1} (a_r - 1)_{(b_r-1)} \right) [p_1 q_1^{a_1-1} \cdots p_m q_m^{a_m-1}] \mathcal{F}(\mathbf{p} \times \mathbf{q}),$$

which thanks to Corollary 7.19 does not depend on the order of the elements in the tuple $(a_1, b_1), \dots, (a_m, b_m)$.

Corollary 7.20. *For any polynomial function \mathcal{F} on the set of generalized Young diagrams and $k_1, \dots, k_l \geq 2$*

$$\left. \frac{\partial}{\partial R_{k_1}} \cdots \frac{\partial}{\partial R_{k_l}} \mathcal{F} \right|_{R_2=R_3=\dots=0} = \sum_{\Pi \in P(1,2,\dots,l)} (-1)^{l-|\Pi|} Q_{((\sum_{i \in b} k_i, |b|): b \in \Pi)}^{\mathcal{F}},$$

where the sum runs over all partitions of $\{1, \dots, l\}$.

Proof. It is enough to use Theorem 7.18 and Equation (122). \square

Lemma 7.21. *For any polynomial function $\mathcal{F} : \mathcal{Y} \rightarrow \mathbb{R}$ and any sequence of integers $k_1, \dots, k_m \geq 1$*

$$[p_1 q_1^{k_1-1} \cdots p_m q_m^{k_m-1}] \mathcal{F}(\mathbf{p} \times \mathbf{q}) = \sum_{\Pi} Q_{((\sum_{i \in b} k_i, |b|): b \in \Pi)}^{\mathcal{F}},$$

where the sum runs over all partitions Π of the set $\{1, \dots, m\}$ with a property that if (a_1, \dots, a_l) with $a_1 < \dots < a_l$ is a block of Π then $k_{a_1} = \dots = k_{a_{l-1}} = 1$ and $k_{a_l} \geq 2$ or, in other words, the set of rightmost legs of the blocks of Π coincides with the set of indices i such that $k_i \geq 2$.

Proof. We shall treat $\mathcal{F}(\mathbf{p} \times \mathbf{q})$ as a polynomial in \mathbf{p} and we shall treat \mathbf{q} as constants. Our goal is to understand the coefficient $[p_1 \cdots p_m] \mathcal{F}(\mathbf{p} \times \mathbf{q})$. Since \mathcal{F} is a polynomial in S_2, S_3, \dots we are also going to investigate analogous coefficients for $\mathcal{F} = S_n$.

For the purpose of the following calculation we shall use the French notation.

$$S_n(\lambda) = (n-1) \iint (\text{contents}_{\square})^{n-2} d\square = (n-2)! \sum_{1 \leq r \leq n-1} (-1)^{r-1} \iint_{(x,y) \in \lambda} \frac{x^{n-1-r}}{(n-1-r)!} \frac{y^{r-1}}{(r-1)!} dx dy.$$

Since the integral

$$\iint_{(x,y) \in \lambda} \frac{x^{n-1-r}}{(n-1-r)!} \frac{y^{r-1}}{(r-1)!} dx dy$$

can be interpreted as the volume of the set

$$\{(x_1, \dots, x_{n-r}, y_1, \dots, y_r) : 0 < x_1 < \dots < x_{n-r} \text{ and } 0 < y_1 < \dots < y_r \text{ and } (x_{n-r}, y_r) \in \lambda\}$$

therefore for any $i_1 < \dots < i_r$

$$[p_{i_1} \cdots p_{i_r}] S_n(\mathbf{p} \times \mathbf{q}) = (-1)^{r-1} (n-1)_{r-1} q_{i_r}^{n-r}. \quad (128)$$

We express \mathcal{F} as a polynomial in S_2, S_3, \dots . Notice that the monomial $p_1 \dots p_m$ can arise in $\mathcal{F}(\mathbf{p} \times \mathbf{q})$ only in the following way : we cluster the factors $p_1 \cdots p_m$ in all possible ways or, in other words, we consider all partitions Π of the set $\{1, \dots, m\}$. Each block of such a partition corresponds to one factor S_n for some value of n . Thanks to Equation (128) we can compare the factors q_1, \dots, q_m which appear with a non-zero exponent and see that only partitions Π which contribute are as prescribed in the formulation of the lemma ; furthermore we can find the correct value of n for each block of Π .

Equation (127) finishes the proof. \square

7.4.3 Stanley-Féray character formula

The following result was conjectured by Stanley [Sta06] and proved by Féray [Fér08b] and therefore we refer to it as Stanley-Féray character formula. For a more elementary proof we refer to [FŚ07].

Theorem 7.22. *The value of the normalized character on $\pi \in \mathfrak{S}(n)$ for a multirectangular Young diagram $\mathbf{p} \times \mathbf{q}$ for $\mathbf{p} = (p_1, \dots, p_r)$, $\mathbf{q} = (q_1, \dots, q_r)$ is given by*

$$\Sigma_{\pi}^{\mathbf{p} \times \mathbf{q}} = \sum_{\substack{\sigma_1, \sigma_2 \in \mathfrak{S}(n) \\ \sigma_1 \circ \sigma_2 = \pi}} \sum_{\phi_2: C(\sigma_2) \rightarrow \{1, \dots, r\}} (-1)^{\sigma_1} \left[\prod_{b \in C(\sigma_1)} q_{\phi_1(b)} \prod_{c \in C(\sigma_2)} p_{\phi_2(c)} \right], \quad (129)$$

where $\phi_1 : C(\sigma_1) \rightarrow \{1, \dots, r\}$ is defined by

$$\phi_1(c) = \max_{\substack{b \in C(\sigma_2), \\ b \text{ and } c \text{ intersect}}} \phi_2(b).$$

Interestingly, the above theorem shows that some partial information about the family of graphs $(\mathcal{V}^{\sigma_1, \sigma_2})_{\sigma_1, \sigma_2}$ can be extracted from the coefficients of Stanley polynomial $\Sigma_{\pi}^{\mathbf{p} \times \mathbf{q}}$. This observation will be essential for the proof of the main result.

The following result is a simple corollary from Theorem 7.22 and it was proved by Féray [Fér08a].

Theorem 7.23. *For any integers $k_1, \dots, k_l \geq 1$ the value of the cumulant $\kappa^{\text{id}}(\Sigma_{k_1}, \dots, \Sigma_{k_l})$ evaluated at the Young diagram $\mathbf{p} \times \mathbf{q}$ is given by*

$$\kappa^{\text{id } \mathbf{p} \times \mathbf{q}}(\Sigma_{k_1}, \dots, \Sigma_{k_l}) = \sum_{\substack{\sigma_1, \sigma_2 \in \mathfrak{S}(n) \\ \sigma_1 \circ \sigma_2 = \pi \\ \langle \sigma, \pi \rangle \text{ transitive}}} \sum_{\phi_2: C(\sigma_2) \rightarrow \{1, \dots, r\}} (-1)^{\sigma_1} \left[\prod_{b \in C(\sigma_1)} q_{\phi_1(b)} \prod_{c \in C(\sigma_2)} p_{\phi_2(c)} \right],$$

where $n = k_1 + \dots + k_l$ and π is a fixed permutation with the cycle structure k_1, \dots, k_l , for example $\pi = (1, 2, \dots, k_1)(k_1 + 1, k_1 + 2, \dots, k_1 + k_2) \dots$, and where ϕ_1 is as in Theorem 7.4.

7.5 Toy example : Quadratic terms of Kerov polynomials

We are on the way towards the proof of Theorem 7.4 which, unfortunately, is a bit technically involved. Before dealing with the complexity of the general case we shall present in this section a proof of Theorem 7.3 which concerns a simplified situation in which we are interested in quadratic terms of Kerov polynomials. This case is sufficiently complex to show the essential elements of the complete proof of Theorem 7.4 but simple enough not to overwhelm the Reader with unnecessary difficulties.

We shall prove Theorem 7.3 in the following equivalent form :

Theorem 7.24. *For all integers $l_1, l_2 \geq 2$ and $k \geq 1$ the derivative*

$$\left. \frac{\partial^2}{\partial R_{l_1} \partial R_{l_2}} K_k \right|_{R_2=R_3=\dots=0}$$

is equal to the number of triples (σ_1, σ_2, q) with the following properties :

- (a) σ_1, σ_2 is a factorization of the cycle ; in other words $\sigma_1, \sigma_2 \in \mathfrak{S}(k)$ are such that $\sigma_1 \circ \sigma_2 = (1, 2, \dots, k)$;
- (b) σ_2 consists of two cycles and σ_1 consists of $l_1 + l_2 - 2$ cycles ;
- (c) $\ell : C(\sigma_2) \rightarrow \{1, 2\}$ is a bijective labeling of the two cycles of σ_2 ;
- (d) for each cycle $c \in C(\sigma_2)$ there are at least $l_{\ell(c)}$ cycles of σ_1 which intersect nontrivially c .

Proof. Equation (122) shows that for any polynomial function \mathcal{F} on the set of generalized Young diagrams

$$\frac{\partial^2}{\partial R_{l_1} \partial R_{l_2}} \mathcal{F} = \frac{\partial^2}{\partial S_{l_1} \partial S_{l_2}} \mathcal{F} + (l_1 + l_2 - 1) \frac{\partial}{\partial S_{l_1 + l_2}} \mathcal{F},$$

where all derivatives are taken at $R_2 = R_3 = \dots = S_2 = S_3 = \dots = 0$. Theorem 7.18 shows that the right-hand side is equal to

$$[p_1 p_2 q_1^{l_1-1} q_2^{l_2-1}] \mathcal{F}(\mathbf{p} \times \mathbf{q}) + (l_1 + l_2 - 1) [p_1 q_1^{l_1+l_2-1}] \mathcal{F}(\mathbf{p} \times \mathbf{q}).$$

Lemma 7.21 applied to the second summand shows therefore that

$$\frac{\partial^2}{\partial R_{l_1} \partial R_{l_2}} \mathcal{F} = [p_1 p_2 q_1^{l_1-1} q_2^{l_2-1}] \mathcal{F}(\mathbf{p} \times \mathbf{q}) - [p_1 p_2 q_2^{l_1+l_2-1}] \mathcal{F}(\mathbf{p} \times \mathbf{q}). \quad (130)$$

In fact, the above equality is a direct application of Corollary 7.20, nevertheless for pedagogical reasons we decided to present the above expanded derivation. In the following we shall use the above identity for $\mathcal{F} = \Sigma_k$.

On the other hand, let us compute the number of the triples $(\sigma_1, \sigma_2, \ell)$ which contribute to the quantity presented in Theorem 7.24. By inclusion-exclusion principle it is equal to

$$\begin{aligned} & (\text{number of triples which fulfill conditions (a)-(c)}) + \\ & \quad (-1) (\text{number of triples for which the cycle } \ell^{-1}(1) \\ & \quad \quad \quad \text{intersects at most } l_1 - 1 \text{ cycles of } \sigma_1) + \\ & \quad (-1) (\text{number of triples for which the cycle } \ell^{-1}(2) \\ & \quad \quad \quad \text{intersects at most } l_2 - 1 \text{ cycles of } \sigma_1). \end{aligned} \quad (131)$$

At first sight it might seem that the above formula is not complete since we should also add the number of triples for which the cycle $\ell^{-1}(1)$ intersects at most $l_1 - 1$ cycles of σ_1 and the cycle $\ell^{-1}(2)$ intersects at most $l_2 - 1$ cycles of σ_1 , however this situation is not possible since σ_1 consists of $l_1 + l_2 - 2$ cycles and $\langle \sigma_1, \sigma_2 \rangle$ acts transitively.

By Stanley-Féray character formula (129) the first summand of (131) is equal to

$$(-1) \sum_{\substack{i+j=l_1+l_2-2, \\ 1 \leq j}} [p_1 p_2 q_1^i q_2^j] \Sigma_k^{\mathbf{p} \times \mathbf{q}}, \quad (132)$$

the second summand of (131) is equal to

$$\sum_{\substack{i+j=l_1+l_2-2, \\ 1 \leq i \leq l_1-1}} [p_1 p_2 q_1^j q_2^i] \Sigma_k^{\mathbf{p} \times \mathbf{q}}, \quad (133)$$

and the third summand of (131) is equal to

$$\sum_{\substack{i+j=l_1+l_2-2, \\ 1 \leq j \leq l_2-1}} [p_1 p_2 q_1^i q_2^j] \Sigma_k^{\mathbf{p} \times \mathbf{q}}. \quad (134)$$

We can apply Corollary 7.19 to the summands of (133); it follows that (133) is equal to

$$\sum_{\substack{i+j=l_1+l_2-2, \\ 1 \leq i \leq l_1-1}} [p_1 p_2 q_1^i q_2^j] \Sigma_k^{\mathbf{p} \times \mathbf{q}}. \quad (135)$$

It remains now to count how many times a pair (i, j) contributes to the sum of (132), (133), (135). It is not difficult to see that the only pairs which contribute are $(0, l_1 + l_2 - 2)$ and $(l_1 - 1, l_2 - 1)$, therefore the number of triples described in the formulation of the Theorem is equal to the right-hand of (130) which finishes the proof. \square

7.6 Combinatorial lemmas

Our strategy of proving the main result of this paper will be to start with the number of factorizations described in Theorem 7.4 and to interpret it as certain linear combination of coefficients of Stanley polynomials for Σ_k . The first step in this direction is promising : Stanley-Féray character formula (Theorem 7.22) shows that indeed Stanley polynomial for Σ_k encodes certain information about the geometry of the bipartite graphs $\mathcal{V}^{\sigma_1, \sigma_2}$ for all factorizations. Unfortunately, condition (e) is quite complicated and at first sight it is not clear how to extract the information about the factorizations fulfilling it from the coefficients of Stanley polynomials.

In this section we will prove three combinatorial lemmas : Corollary 7.26, Corollary 7.28 and Corollary 7.29 which solve this difficulty.

7.6.1 Euler characteristic

Let \mathcal{I} be a family of some subsets of a given finite set \mathcal{X} . We define

$$\chi(\mathcal{I}) = \sum_{l \geq 1} \sum_{\substack{C=(C_1 \subsetneq \dots \subsetneq C_l), \\ C_1, \dots, C_l \in \mathcal{I}}} (-1)^{l-1},$$

where the sum runs over all non-empty chains $C = (C_1 \subsetneq \dots \subsetneq C_l)$ contained in \mathcal{I} . In such a situation we will also say that C is l -chain and $|C| = l$. Notice that family \mathcal{I} gives rise to a simplicial complex \mathcal{K} with $l - 1$ -simplices corresponding to l -chains contained in \mathcal{I} and the above quantity $\chi(\mathcal{I})$ is just the Euler characteristic of \mathcal{K} .

The following lemma shows that under certain assumptions this Euler characteristic is equal to 1 ; we leave it as an exercise to adapt the proof to show a stronger statement that under the same assumptions \mathcal{K} is in fact contractible (we will not use this stronger result in this article).

Lemma 7.25. *Let \mathcal{I} be a non-empty family with a property that*

$$A \cap B \in \mathcal{I} \quad \text{or} \quad A \cup B \in \mathcal{I} \quad \text{holds for all } A, B \in \mathcal{I}. \quad (136)$$

Then

$$\chi(\mathcal{I}) = 1.$$

Proof. Let $\mathcal{X} = \{x_1, \dots, x_n\}$. We define

$$\mathcal{I}_k = \{A \cup \{x_1, \dots, x_k\} : A \in \mathcal{I}\}.$$

Clearly $\mathcal{I}_0 = \mathcal{I}$ and $\mathcal{I}_n = \{\mathcal{X}\}$ therefore $\chi(\mathcal{I}_n) = 1$. It remains to prove that $\chi(\mathcal{I}_{k-1}) = \chi(\mathcal{I}_k)$ holds for all $1 \leq k \leq n$ and we shall do it in the following.

Let us fix k . For an l -chain $C = (C_1 \subsetneq \dots \subsetneq C_l)$ contained in \mathcal{I}_{k-1} we define

$$\iota_k(C) = (C_1 \cup \{x_k\} \subseteq \dots \subseteq C_l \cup \{x_k\})$$

which is a chain contained in \mathcal{I}_k . Notice that $\iota_k(C)$ is either an $l-1$ -chain (if $C_{i+1} = C_i \cup \{x_k\}$ for some i) or l -chain (otherwise). With these notations we have

$$\chi(\mathcal{I}_{k-1}) = \sum_{C:\text{non-empty chain in } \mathcal{I}_{k-1}} (-1)^{|C|-1} = \sum_{D:\text{non-empty chain in } \mathcal{I}_k} \sum_{\substack{C:\text{non-empty chain in } \mathcal{I}_{k-1}, \\ \iota_k(C)=D}} (-1)^{|C|-1}.$$

In order to prove $\chi(\mathcal{I}_{k-1}) = \chi(\mathcal{I}_k)$ it is enough now to show that for any non-empty chain $D = (D_1 \subsetneq \dots \subsetneq D_l)$ contained in \mathcal{I}_k

$$(-1)^{|D|-1} = \sum_{\substack{C:\text{non-empty chain in } \mathcal{I}_{k-1}, \\ \iota_k(C)=D}} (-1)^{|C|-1}. \tag{137}$$

Let $1 \leq p \leq l$ be the maximal index with a property that $D_p \notin \mathcal{I}_{k-1}$; if no such index exists we set $p = 0$. In the remaining part of this paragraph we will show that $D_i \setminus \{x_k\} \in \mathcal{I}_{k-1}$ holds for all $1 \leq i \leq p$. Clearly, in the cases when $p = 0$ or $i = p$ there is nothing to prove. Assume that $i < p$ and $D_i \setminus \{x_k\} \notin \mathcal{I}_{k-1}$. Since $D_i \in \mathcal{I}_k$ it follows that $x_k \in D_i \in \mathcal{I}_{k-1}$. It is easy to check that an analogue of (136) holds true for the family \mathcal{I}_{k-1} . We apply this property for $A = D_i$ and $B = D_p \setminus \{x_k\}$ which results in a contradiction since $A \cap B = D_i \setminus \{x_k\} \notin \mathcal{I}_{k-1}$ and $A \cup B = D_p \notin \mathcal{I}_{k-1}$.

Let $1 \leq q \leq l$ be the minimal index with a property that $x_k \in D_q$; if no such index exists we set $q = n + 1$. Similarly as above we show that $D_i \in \mathcal{I}_{k-1}$ holds for all $q \leq i \leq l$.

The above analysis shows that a chain C contained in \mathcal{I}_{k-1} such that $\iota_k(C) = D$ must have one of the following two forms :

1. if $C = (C_1, \dots, C_l)$ is a l -chain then there exists a number r ($p \leq r < q$) such that

$$C_i = \begin{cases} D_i \setminus \{x_k\} & \text{for } 1 \leq i \leq r, \\ D_i & \text{for } r < i \leq l, \end{cases}$$

2. if $C = (C_1, \dots, C_{l+1})$ is a $l+1$ -chain then there exists a number r ($p < r < q$) such that

$$C_i = \begin{cases} D_i \setminus \{x_k\} & \text{for } 1 \leq i \leq r, \\ D_{i-1} & \text{for } r < i \leq l+1. \end{cases}$$

There are $q - p$ choices for the first case and there are $q - p - 1$ choices for the second case and (137) follows. □

7.6.2 Applications of Euler characteristic

Corollary 7.26. *Let $\sigma_1, \sigma_2 \in \mathfrak{S}(k)$ be permutations such that $\langle \sigma_1, \sigma_2 \rangle$ acts transitively and let $q : C(\sigma_2) \rightarrow \{2, 3, \dots\}$ be a coloring with a property that*

$$\sum_{i \in C(\sigma_2)} q(i) = |C(\sigma_1)| + |C(\sigma_2)|.$$

We define \mathcal{I} to be a family of the sets $A \subset C(\sigma_2)$ with the following two properties :

- $A \neq \emptyset$ and $A \neq C(\sigma_2)$,
- there are at most $\sum_{i \in A} (q(i) - 1)$ cycles of σ_1 which intersect $\bigcup A$.

Then

$$\sum_{l \geq 0} \sum_{\substack{C=(C_1 \sqsubset \dots \sqsubset C_l), \\ C_1, \dots, C_l \in \mathcal{I}}} (-1)^l = \begin{cases} 1 & \text{if } \mathcal{I} = \emptyset, \\ 0 & \text{otherwise.} \end{cases} \quad (138)$$

Proof. It is enough to prove that the family \mathcal{I} fulfills the assumption of Lemma 7.25; we shall do it in the following. For $A \subseteq C(\sigma_2)$ we define

$$f(A) = \left(\text{number of cycles of } \sigma_1 \text{ which intersect } \bigcup A \right) - \sum_{i \in A} (q(i) - 1).$$

In this way $A \in \mathcal{I}$ iff $A \neq \emptyset$, $A \neq C(\sigma_2)$ and $f(A) \leq 0$.

It is easy to check that for any $A, B \subseteq C(\sigma_2)$

$$f(A) + f(B) \geq f(A \cup B) + f(A \cap B) \quad (139)$$

therefore if $A, B \in \mathcal{I}$ then $f(A \cup B) \leq 0$ or $f(A \cap B) \leq 0$. If $A \cap B \neq \emptyset$ and $A \cup B \neq C(\sigma_2)$ this finishes the proof. Since $f(\emptyset) = f(C(\sigma_2)) = 0$ also the case when either $A \cap B = \emptyset$ or $A \cup B = C(\sigma_2)$ follows immediately.

It follows that if $A, B \in \mathcal{I}$ and $A \cap B, A \cup B \notin \mathcal{I}$ then $A, B \neq \emptyset$, $A \cap B = \emptyset$, $A \cup B = C(\sigma_2)$, $f(A) = f(B) = 0$. The latter equality shows that

$$\begin{aligned} & \left(\text{number of cycles of } \sigma_1 \text{ which intersect } \bigcup A \right) + \\ & \left(\text{number of cycles of } \sigma_1 \text{ which intersect } \bigcup B \right) = |C(\sigma_1)| \end{aligned}$$

therefore each cycle of σ_1 intersects either $\bigcup A$ or $\bigcup B$ which contradicts transitivity. \square

Lemma 7.27. For any $n \geq 1$

$$\sum_k (-1)^k \left\{ \begin{matrix} n \\ k \end{matrix} \right\} k! = (-1)^n, \quad (140)$$

where $\left\{ \begin{matrix} n \\ k \end{matrix} \right\}$ denotes the Stirling symbol of the first kind, namely the number of ways of partitioning n -element set into k non-empty classes.

Proof. A simple inductive proof follows from the recurrence relation

$$\left\{ \begin{matrix} n \\ k \end{matrix} \right\} = k \left\{ \begin{matrix} n-1 \\ k \end{matrix} \right\} + \left\{ \begin{matrix} n-1 \\ k-1 \end{matrix} \right\}.$$

\square

Corollary 7.28. *Let $r \geq 1$ and let k_1, \dots, k_r and n_1, \dots, n_r be numbers such that $k_1 + \dots + k_r = n_1 + \dots + n_r$. We define \mathcal{I} to be a family of the sets $A \subset \{1, \dots, r\}$ with the following properties : $A \neq \emptyset$ and $A \neq \{1, \dots, r\}$ and*

$$\sum_{i \in A} k_i \leq \sum_{i \in A} n_i.$$

Then

$$\sum_{l \geq 0} \sum_{\substack{C = (C_1 \subsetneq \dots \subsetneq C_l), \\ C_1, \dots, C_l \in \mathcal{I}}} (-1)^l = \begin{cases} (-1)^{r-1} & \text{if } (k_1, \dots, k_r) = (n_1, \dots, n_r), \\ 0 & \text{otherwise.} \end{cases} \quad (141)$$

Proof. If $(k_1, \dots, k_r) = (n_1, \dots, n_r)$ then \mathcal{I} consists of all subsets of $\{1, \dots, r\}$ with the exception of \emptyset and $\{1, \dots, r\}$. Therefore there is a bijective correspondence between the chains $C = (C_1 \subsetneq \dots \subsetneq C_l)$ which contribute to the left-hand side of (141) and sequences (D_1, \dots, D_{l+1}) of non-empty and disjoint sets such that $D_1 \cup \dots \cup D_{l+1} = \{1, 2, \dots, r\}$; this correspondence is defined by requirement that

$$C_i = D_1 \cup \dots \cup D_i.$$

It follows that the left-hand side of (141) is equal to

$$\sum_l (-1)^l \left\{ \begin{matrix} n \\ l+1 \end{matrix} \right\} (l+1)!$$

which can be evaluated thanks to (140).

We consider the case when $(k_1, \dots, k_r) \neq (n_1, \dots, n_r)$; for simplicity we assume that $k_1 \neq n_1$. We define

$$f(A) = \sum_{i \in A} (k_i - n_i)$$

which fulfills (139) and similarly as in the proof of Corollary 7.26 we conclude that condition (136) is fulfilled under additional assumption that $A \cap B \neq \emptyset$ or $A \cup B \neq \{1, 2, \dots, r\}$; this means that Lemma 7.25 cannot be applied directly and we must analyze the details of its proof. We select the sequence x_1, x_2, \dots used in the proof of Lemma 7.25 in such a way that $x_1 = 1$. A careful inspection shows that the proof of the equality $\chi(\mathcal{I}_0) = \chi(\mathcal{I}_1)$ presented above is still valid. Since families $\mathcal{I}_1, \mathcal{I}_2, \dots$ fulfill condition (136) therefore $\chi(\mathcal{I}_1) = \chi(\mathcal{I}_2) = \dots = 0$. \square

Corollary 7.29. *Let $r \geq 1$, let $\Pi \in P(1, 2, \dots, r)$ be a partition, let n_1, \dots, n_r be numbers and let $\phi : \Pi \rightarrow \mathbb{R}$ be a function on the set of blocks of the partition Π with a property that*

$$\sum_{b \in \Pi} \phi(b) = n_1 + \dots + n_r$$

and $\phi(b) \geq |b|$ holds for each block $b \in \Pi$. We define \mathcal{I} to be a family of the sets $A \subset \{1, \dots, r\}$ with the following properties : $A \neq \emptyset$ and $A \neq \{1, \dots, r\}$ and

$$\sum_{\substack{b \in \Pi, \\ b \cap A \neq \emptyset}} (\phi(b) - |b \setminus A|) \leq \sum_{i \in A} n_i.$$

Then

$$\sum_{l \geq 0} \sum_{\substack{C=(C_1 \sqsubset \dots \sqsubset C_l), \\ C_1, \dots, C_l \in \mathcal{I}}} (-1)^l = \begin{cases} (-1)^{|\Pi|-1} & \text{if } \phi(b) = \sum_{i \in b} n_i \\ & \text{holds for each block } b \in \Pi, \\ 0 & \text{otherwise.} \end{cases} \quad (142)$$

Proof. We define

$$f(A) = |A| + \sum_{\substack{b \in \Pi, \\ b \cap A \neq \emptyset}} (\phi(b) - |b|)$$

which fulfills (139). The remaining part of the proof is analogous to Corollary 7.28. □

7.7 Proof of the main result

We will prove Theorem 7.4 in the following equivalent form.

Theorem 7.30 (The main result, reformulated). *Let $k \geq 1$ and let $n_1, \dots, n_r \geq 2$ be a sequence of integers. The derivative of Kerov polynomial*

$$\left. \frac{\partial}{\partial R_{n_1}} \dots \frac{\partial}{\partial R_{n_r}} K_k \right|_{R_2=R_3=\dots=0}$$

is equal to the number of triples $(\sigma_1, \sigma_2, \ell)$ with the following properties :

- (a) σ_1, σ_2 is a factorization of the cycle ; in other words $\sigma_1, \sigma_2 \in \mathfrak{S}(k)$ are such that $\sigma_1 \circ \sigma_2 = (1, 2, \dots, k)$;
- (b) $|C(\sigma_2)| = r$;
- (c) $|C(\sigma_1)| + |C(\sigma_2)| = n_1 + \dots + n_r$;
- (d) $\ell : C(\sigma_2) \rightarrow \{1, \dots, r\}$ is a bijection ;
- (e) for every set $A \subset C(\sigma_2)$ which is nontrivial (i.e., $A \neq \emptyset$ and $A \neq C(\sigma_2)$) we require that there are more than $\sum_{i \in A} (n_{\ell(i)} - 1)$ cycles of σ_1 which intersect $\bigcup A$.

Proof. Let us sum both sides of (138) over all triples $(\sigma_1, \sigma_2, \ell)$ for which conditions (a)–(d) are fulfilled; for such triples we define the coloring $q : C(\sigma_2) \rightarrow \{2, 3, \dots\}$ by $q(i) = n_{\ell(i)}$. It follows that the number of triples which fulfill all conditions from the formulation of the theorem is equal to

$$\sum_{l \geq 0} \sum_{\substack{C=(C_1, \dots, C_l), \\ \emptyset \subsetneq C_1 \subsetneq \dots \subsetneq C_l \subsetneq \{1, 2, \dots, r\}}} (-1)^l \text{Bad}_C, \quad (143)$$

where Bad_C for $C = (C_1, \dots, C_l)$ denotes the number of triples $(\sigma_1, \sigma_2, \ell)$ which fulfill (a)–(d) and such that for each $1 \leq j \leq l$ there are at most $\sum_{i \in C_j} (n_i - 1)$ cycles of σ_1 which intersect $\bigcup_{i \in C_j} \ell^{-1}(i)$.

Theorem 7.22 shows that

$$\text{Bad}_C = (-1)^{r-1} \sum_{k_1, \dots, k_r} [p_1 \dots p_r q_1^{k_1-1} \dots q_r^{k_r-1}] \Sigma_k^{\mathbf{p} \times \mathbf{q}}, \quad (144)$$

where the above sum is taken over all integers $k_1, \dots, k_r \geq 1$ such that

$$k_1 + \dots + k_r = n_1 + \dots + n_r \quad (145)$$

and

$$\underbrace{k_{r+1-|C_j|} + \dots + k_r}_{|C_j| \text{ summands}} \leq \sum_{i \in C_j} n_i \quad \text{holds for each } 1 \leq j \leq l. \quad (146)$$

We apply Lemma 7.21 to the right-hand side of (144). Therefore

$$\text{Bad}_C = (-1)^{r-1} \sum_{\Pi \in P(1,2,\dots,r)} \sum_{k_1,\dots,k_r} Q_{\left(\left(\sum_{i \in b} k_i, |b|\right) : b \in \Pi\right)}^{\Sigma_k} \quad (147)$$

where the first sum runs over all partitions Π of the set $\{1, 2, \dots, r\}$ and the second sum runs over the tuples k_1, \dots, k_r which fulfill conditions (145), (146) and such that the set of indices i such that $k_i \geq 2$ coincides with the set of rightmost legs of the blocks of Π .

For simplicity, before dealing with the general case, we shall analyze first the contribution of the trivial partition which consists only of singletons. We define $\text{Bad}_C^{\text{trivial}}$ to be the expression (147) with the sum over partitions replaced by only one summand for $\Pi = \{\{1\}, \{2\}, \dots, \{r\}\}$, i.e.

$$\text{Bad}_C^{\text{trivial}} = (-1)^{r-1} \sum_{k_1,\dots,k_r} Q_{(k_1,1),\dots,(k_r,1)}^{\Sigma_k} \quad (148)$$

where the sum runs over the same set as in Equation (144) with an additional restriction $k_1, \dots, k_r \geq 2$.

Corollary 7.19 shows that we may change the order of the elements in the sequence (k_1, \dots, k_r) hence (148) holds true also if the sum on the right-hand side runs over all integers $k_1, \dots, k_r \geq 2$ such that $k_1 + \dots + k_r = n_1 + \dots + n_r$ and such that for each $1 \leq j \leq l$

$$\sum_{i \in C_j} k_i \leq \sum_{i \in C_j} n_i.$$

Therefore for an analogue of the sum (143) Corollary 7.28 shows that

$$\sum_{l \geq 0} \sum_{\substack{C=(C_1,\dots,C_l), \\ \emptyset \subsetneq C_1 \subsetneq \dots \subsetneq C_l \subsetneq \{1,2,\dots,r\}}} (-1)^l \text{Bad}_C^{\text{trivial}} = (-1)^{r-1} Q_{(n_1,1),\dots,(n_r,1)}^{\Sigma_k}.$$

Notice the the right-hand side is the summand appearing in Corollary 7.20 for the trivial partition Π which is quite encouraging.

Having in mind the above simplified case let us tackle the general partitions Π . Corollary 7.19 shows that we may shuffle the blocks of partition Π hence from (147) it follows that

$$\text{Bad}_C = (-1)^{r-1} \sum_{\Pi \in P(1,2,\dots,r)} \sum_{\phi} Q_{\left(\left(\phi(b), |b|\right) : b \in \Pi\right)}^{\Sigma_k}, \quad (149)$$

where the second sum runs over all functions ϕ which assign integer numbers to blocks of Π and such that :

- $\phi(b) \geq |b| + 1$ holds for every block $b \in \Pi$;
- $\sum_{b \in \Pi} \phi(b) = n_1 + \dots + n_r$;

$$\sum_{\substack{b \in \Pi, \\ b \cap C_j \neq \emptyset}} (\phi(b) - |b \setminus C_j|) \leq \sum_{i \in C_j} n_i$$

holds for each $1 \leq j \leq l$.

Therefore (143) is equal to

$$\sum_{\Pi \in P(1,2,\dots,r)} \sum_{\phi} Q^{\Sigma_k} \left(\left(\phi(b), |b| \right) : b \in \Pi \right) \left[\sum_{l \geq 0} \sum_{\substack{C=(C_1,\dots,C_l), \\ \emptyset \subsetneq C_1 \subsetneq \dots \subsetneq C_l \subsetneq \{1,2,\dots,r\}}} (-1)^{l+r-1} \right].$$

Corollary 7.29 can be used to calculate the expression in the bracket hence the above sum is equal to

$$\sum_{\Pi \in P(1,2,\dots,r)} Q^{\Sigma_k} \left(\left(\sum_{i \in b} n_i, |b| \right) : b \in \Pi \right) (-1)^{r-|\Pi|}.$$

Corollary 7.20 finishes the proof. \square

Proof of Theorem 7.6 is analogous (the reference to Theorem 7.22 should be replaced by Theorem 7.23) and we skip it.

7.8 Graph decomposition

In this section we will compare our main result with the previous complicated combinatorial description of the coefficients of Kerov's polynomials proposed by Féray in [Fér08a]. This will lead us to a new proof of the main result of this paper, Theorem 7.4 and Theorem 7.6.

7.8.1 Reformulation of the previous result

Let us consider the formal sum of the collection of graphs $(\mathcal{V}^{\sigma_1, \sigma_2})_{\sigma_1, \sigma_2}$ over all factorizations $\sigma_1 \cdot \sigma_2 = (1, 2, \dots, k)$ (these graphs were defined in Section 7.1.8 but in order to be compatible with the notation of the paper [Fér08a] it might be more convenient to allow multiple edges connecting two cycles with the multiplicity equal to the number of the elements in the common support). Let us apply the local transformations presented on Figure 7.4 (the reader can easily imagine the generalizations of the the drawn transformation to bigger loops : for a given oriented loop of length $2k$ we remove in $2^k - 1$ ways all non-empty subsets of the set of edges oriented from a black vertex to a white vertex with the plus or minus sign depending if the number of removed edges is odd or even) to each of the summands and let us iterate this procedure until we obtain a formal linear combination of forests. Of course, the final result S may depend on the choice of the loops used for the transformations, so in order to have a uniquely determined result we have to choose the loops in some special way,

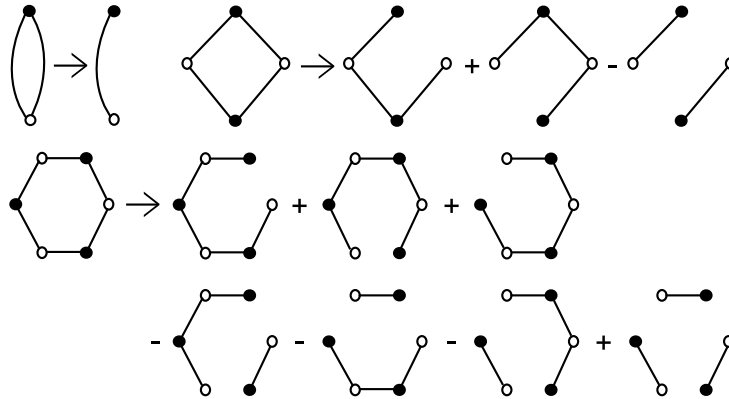

FIG. 7.4 – Local transformations on graphs.

for example as described in paper [Fér08a], the details of which will not be important for this article.

Then we have the following result :

Theorem 7.31 (Féray [Fér08a]). *The coefficient of $R_2^{s_2} R_3^{s_3} \dots$ in K_k is equal to $(-1)^{1+s_2+s_3+\dots}$ times the total sum of coefficients of all forests in S which consist of s_i trees with one black and $i - 1$ white vertices (i runs over $\{2, 3, \dots\}$).*

We will reformulate this result in a form closer to Theorem 7.4. For this purpose, if (σ_1, σ_2, q) is a triple verifying conditions (a)–(d) and F is a subforest of $\mathcal{V}^{\sigma_1, \sigma_2}$ with the same set of vertices, we will say that F is a q -forest if the following two conditions are fulfilled :

- all cycles of σ_2 (black vertices) are in different connected components,
- each cycle c of σ_2 is the neighbor of exactly $q(c) - 1$ cycles of σ_1 (white vertices).

Theorem 7.32. *Let $k \geq 1$ and let s_2, s_3, \dots be a sequence of non-negative integers with only finitely many non-zero elements. The coefficient of the monomial $R_2^{s_2} R_3^{s_3} \dots$ in the Kerov polynomial K_k is equal to the number of triples (σ_1, σ_2, q) which fulfill conditions (a)–(d) of Theorem 7.4 and such that*

(e⁵) *when we apply the transformations from Figure 7.4 as prescribed in [Fér08a, Section 3], in the resulting linear combination of forests there is (exactly one) q -forest.*

It is easy to see that this theorem is a reformulation of Theorem 7.31. A priori, it might seem that in the theorem above we should count each triplet (σ_1, σ_2, q) with multiplicity equal to the number of q -forests appearing in the result, but we will prove in Corollary 7.34 that it is always equal to 0 or 1.

Comparing Theorem 7.32 with Theorem 7.4 we may wonder if conditions (e) and (e⁵) are equivalent. We will prove their equivalence in the following section.

7.8.2 Equivalence of conditions (e) and (e⁵)

In Section 7.1.9 we introduced the notion of q -admissibility of a graph. Recall that if a graph G is connected then it is q -admissible if and only if it satisfies condition (e³) which is

a reformulation of (e). Notice also that if G contains no loops then it is q -admissible if and only if it is a q -forest.

Lemma 7.33. *The sum of coefficients of q -admissible graphs G counted with multiplicity $(-1)^{(\text{number of connected components of } G)}$ in a formal linear combination of bipartite graphs with a given set of vertices and labeling $q : V_{\bullet} \rightarrow \{2, 3, \dots\}$ does not change after performing any transformation of the form presented on Figure 7.4.*

Proof. Let us choose some oriented loop L in graph G and let us denote by E the set of edges which can be erased in the corresponding local transformation from Figure 7.4; in other words E consists of every second edge in the loop L .

Consider the convex polyhedron P (without boundary) which is the set of all positive solutions $(x_e)_{e \text{ is an edge of } G}$ to the system of equations from condition (e⁴).

If f is a real function on the set of edges of G and v is a vertex of G we define $(\Phi(f))(v)$ to be the sum of values of f on edges adjacent to v . If P is non-empty then its dimension is equal to the dimension of $\ker \Phi$. It is a simple exercise to show that $\text{Im } \Phi$ consists of all functions on vertices of G with a property that for each connected component of G the sum of values on black vertices is equal to the sum of values on white vertices hence

$$\dim \text{Im } \Phi = (\text{number of vertices of } G) - (\text{number of components of } G).$$

It follows from rank-nullity theorem that

$$\begin{aligned} \dim P &= \dim \ker \Phi = (\text{number of edges of } G) \\ &\quad - (\text{number of vertices of } G) + (\text{number of connected components of } G). \end{aligned} \quad (150)$$

For a positive solution (x_e) of our system of equations and a real number t we define

$$y_e = \begin{cases} x_e & \text{if } e \notin L, \\ x_e + t & \text{if } e \in (L \setminus E), \\ x_e - t & \text{if } e \in E. \end{cases}$$

which is also a solution. Let t be the minimal positive number for which (y_e) is not positive. In this way we define a map $\Pi : (x_e) \mapsto (y_e)$.

For any non-empty $A \subseteq E$ we define P_A to be the set of positive solutions with a property that

$$\forall_{e \in E} \quad e \in A \iff x_e = \min_{f \in E} x_f.$$

Since the defining condition for P_A can be written in terms of some equations and inequalities it follows that P_A is a convex polyhedron. It is easy to check that

$$\Pi(P_A) = \{(x_e) : \text{non-negative solution such that } \forall_{e: \text{edge of } G} (x_e = 0) \iff (e \in A)\}.$$

The latter set can be identified with the set of positive solutions for our system of equations corresponding to the graph $G' = G \setminus A$. It follows that

$$\begin{aligned} \dim P_A &= 1 + \dim \Pi(P_A) = 1 + (\text{number of edges of } (G \setminus A)) \\ &\quad - (\text{number of vertices of } G) + (\text{number of connected components of } (G \setminus A)), \end{aligned} \quad (151)$$

where the last equality is just (150) applied to $G' = G \setminus A$.

It is easy to see that $P = \bigsqcup_{A \neq \emptyset} P_A$ is a disjoint union therefore we have the equality between the Euler characteristics :

$$\chi(P) = \sum_{A \neq \emptyset} \chi(P_A)$$

which thanks to (150) and (151) shows that

$$\begin{aligned} (-1)^{(\text{number of connected components of } G)} [P \text{ is non-empty}] = \\ \sum_{A \neq \emptyset} (-1)^{|A|-1} (-1)^{(\text{number of components of } G \setminus A)} [P_A \text{ is non-empty}], \end{aligned} \quad (152)$$

where we use the convention that

$$[(\text{condition})] = \begin{cases} 1 & \text{if (condition) is true,} \\ 0 & \text{otherwise.} \end{cases}$$

Proposition 7.9 shows that P (respectively, P_A) is non-empty if and only if G (respectively, $G \setminus A$) is q -admissible therefore (152) is equivalent to

$$\begin{aligned} (-1)^{(\text{number of components of } G)} [G \text{ is } q\text{-admissible}] = \\ \sum_{A \neq \emptyset} (-1)^{|A|-1} (-1)^{(\text{number of components of } G \setminus A)} [(G \setminus A) \text{ is } q\text{-admissible}], \end{aligned}$$

which is the desired equality. □

Corollary 7.34. *Suppose that (σ_1, σ_2, q) is a triple verifying the conditions (a)–(d) of Theorem 7.4. If we iterate local transformations from Figure 7.4 on $\mathcal{V}^{\sigma_1, \sigma_2}$ until we obtain a formal linear combination of forests (not necessarily choosing the loops as prescribed in [Fér08a]) then the sum of coefficients of q -forests in the result is equal to*

$$\begin{cases} (-1)^{1+s_2+s_3+\dots} & \text{if condition (e) is fulfilled;} \\ 0 & \text{otherwise.} \end{cases}$$

In the case when we perform the transformations as prescribed in [Fér08a, Section 3], the sign property of this decomposition ([Fér08a, Proposition 3.3.1]) implies that there is exactly one q -forest (with the appropriate sign) in the resulting sum if condition (e) is fulfilled and there are no q -forests otherwise; in other words condition (e) is equivalent to (e⁵).

Analogous results can be stated for the situation presented in Theorem 7.6.

The above corollary together with Theorem 7.32 give another proof of the main result of the paper, Theorem 7.4 and Theorem 7.6. In such a proof the difficulty is moved to the proof of Theorem 7.31 which was proved in a not easy paper [Fér08a].

Quatrième partie

Application de la combinatoire des
polynômes de Kerov à des identités
rationnelles sur les ensembles ordonnés

8

Application of graph combinatorics to rational identities of type A

Ce chapitre reprend le contenu de l'article [BF09], écrit en collaboration avec Adrien Boussicault.

This chapter corresponds to the article [BF09], written with A. Boussicault.

Résumé

À un mot w , nous associons la fonction rationnelle $\Psi_w = \prod (x_{w_i} - x_{w_{i+1}})^{-1}$. L'objet principal, introduit par C. Greene pour généraliser des identités rationnelles liées à la règle de Murnaghan-Nakayama, est une somme de ses images par certaines permutations des variables. Les ensembles de permutations considérés sont les extensions linéaires des graphes orientés. Nous expliquons comment calculer cette fonction rationnelle à partir de la combinatoire du graphe G . Nous établissons ensuite un lien entre une propriété algébrique de la fonction rationnelle (la factorisation du numérateur) et une propriété combinatoire du graphe (l'existence d'une chaîne le déconnectant).

Abstract

To a word w , we associate the rational function $\Psi_w = \prod (x_{w_i} - x_{w_{i+1}})^{-1}$. The main object, introduced by C. Greene to generalize identities linked to Murnaghan-Nakayama rule, is a sum of its images by certain permutations of the variables. The sets of permutations that we consider are the linear extensions of oriented graphs. We explain how to compute this rational function, using the combinatorics of the graph G . We also establish a link between an algebraic property of the rational function (the factorization of the numerator) and a combinatorial property of the graph (the existence of a disconnecting chain).

8.1 Introduction

A partially ordered set (poset) \mathcal{P} is a finite set V endowed with a partial order. By definition, a word w containing exactly once each element of V is called a linear extension if the order of its letters is compatible with \mathcal{P} (if $a \leq_{\mathcal{P}} b$, then a must be before b in w). To a linear extension $w = v_1 v_2 \dots v_n$, we associate a rational function :

$$\psi_w = \frac{1}{(x_{v_1} - x_{v_2}) \cdot (x_{v_2} - x_{v_3}) \dots (x_{v_{n-1}} - x_{v_n})}.$$

We can now introduce the main object of the paper. If we denote by $\mathcal{L}(\mathcal{P})$ the set of linear extensions of \mathcal{P} , then we define $\Psi_{\mathcal{P}}$ by :

$$\Psi_{\mathcal{P}} = \sum_{w \in \mathcal{L}(\mathcal{P})} \psi_w.$$

8.1.1 Background

The linear extensions of posets contain very interesting subsets of the symmetric group : for example, the linear extensions of the poset considered in the article [BMB07] are the permutations smaller than a permutation π for the left weak order. In this case, our construction is close to that of Demazure characters [Dem74]. S. Butler and M. Bousquet-Mélou characterize the permutations π corresponding to acyclic posets, which are exactly the cases where the function we consider is the simplest.

Moreover, linear extensions are hidden in a recent formula for irreducible character values of the symmetric group : if we use the notations of [FŚ07], the quantity $N^{\lambda}(G)$ can be seen as a sum over the linear extensions of the bipartite graph G (bipartite graphs are a particular case of oriented graphs). This explains the similarity of the combinatorics in article [Fér08a] and in this one.

The function $\Psi_{\mathcal{P}}$ was considered by C. Greene [Gre92], who wanted to generalize a rational identity linked to Murnaghan-Nakayama rule for irreducible character values of the symmetric group. He has given in his article a closed formula for planar posets ($\mu_{\mathcal{P}}$ is the Möbius function of \mathcal{P}) :

$$\Psi_{\mathcal{P}} = \begin{cases} 0 & \text{if } \mathcal{P} \text{ is not connected,} \\ \prod_{y,z \in \mathcal{P}} (x_y - x_z)^{\mu_{\mathcal{P}}(y,z)} & \text{if } \mathcal{P} \text{ is connected,} \end{cases}$$

However, there is no such formula for general posets, only the denominator of the reduced form of $\Psi_{\mathcal{P}}$ is known [Bou07]. In this article, the first author has investigated the effects of elementary transformations of the Hasse diagram of a poset on the numerator of the associated rational function. He has also noticed, that in some case, the numerator is a specialization of a Schur function [Bou07, paragraph 4.2] (we can also find multiSchur functions or Schubert polynomials).

In this paper, we obtain some new results on this numerator, thanks to a simple local transformation in the graph algebra, preserving linear extensions.

8.1.2 Main results

8.1.2.1 An inductive algorithm

The first main result of this paper is an induction relation on linear extensions (Theorem 8.4). When one applies Ψ on it, it gives an efficient algorithm to compute the numerator of the reduced fraction of $\Psi_{\mathcal{P}}$ (the denominator is already known).

8.1.2.2 A combinatorial formula

If we iterate our first main result in a clever way, we can describe combinatorially the final result. The consequence is our second main result : if we give to the graph of a poset \mathcal{P} a rooted map structure, we have a combinatorial non-inductive formula for the numerator of $\Psi_{\mathcal{P}}$ (Theorem 8.17).

8.1.2.3 A condition for $\Psi_{\mathcal{P}}$ to factorize

Greene formula's for the function associated to a planar poset is a quotient of products of polynomials of degree 1. In the non-planar case, the denominator is still a product of degree 1 terms, but not the numerator. So we may wonder when the numerator $N(\mathcal{P})$ can be factorized.

Our third main result is a partial answer (a sufficient but not necessary condition) to this question : the numerator $N(\mathcal{P})$ factorizes if there is a chain disconnecting the Hasse diagram of \mathcal{P} (see Theorem 8.18 for a precise statement). An example is drawn on figure 8.1 (the disconnecting chain is $(2, 5)$). Note that we use here and in the whole paper a unusual convention : we draw the posets from left (minimal elements) to right (maximal elements).

$$N \begin{pmatrix} 4 & 6 \\ \bullet & \bullet \\ 2 & 5 \\ \bullet & \bullet \\ 1 & 3 \\ \bullet & \bullet \end{pmatrix} = N \begin{pmatrix} 2 & 5 \\ \bullet & \bullet \\ 1 & 3 \\ \bullet & \bullet \end{pmatrix} \cdot N \begin{pmatrix} 4 & 6 \\ \bullet & \bullet \\ 2 & 5 \\ \bullet & \bullet \end{pmatrix}$$

FIG. 8.1 – Example of chain factorization

8.1.3 Open problems

8.1.3.1 Around the map structure

Theorem 8.17 is a combinatorial formula for the numerator of $\Psi_{\mathcal{P}}$ involving a map structure on the corresponding graph. Can we find a formula, which does not depend any additional structure on the graph ?

Furthermore if we use ordered-embeddings of graphs in $\mathbb{R} \times \mathbb{R}$ (see definition 8.9), the map structure is not independant from the poset structure. Is there a way to use this link ?

8.1.3.2 Necessary condition for factorization

The conclusion of the factorization Theorem 8.18 is sometimes true, even when the separating path is not a chain : see for example Figure 8.2 (the path (5,6,3) disconnects the Hasse diagram, but is not a chain).

This equality, and many more, can be easily proved using the same method as Theorem 8.18. Can we give a necessary (and sufficient) condition for the numerator of a poset to factorize into a product of numerators of subsets? Are all factorizations of this kind?

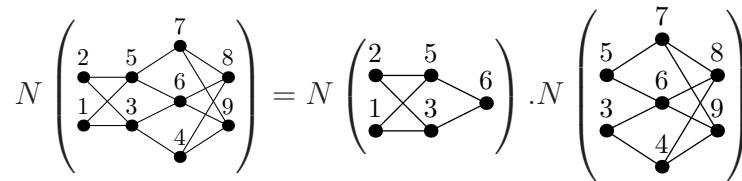

FIG. 8.2 – An example of factorization, not contained in Theorem 8.18.

8.1.3.3 Characterisation of the numerator

Let us consider a bipartite poset \mathcal{P} (which has only minimal and maximal elements, respectively a_1, \dots, a_l and b_1, \dots, b_r). The numerator $N(\mathcal{P})$ of $\Psi_{\mathcal{P}}$ is a polynomial in b_1, \dots, b_r which degree in each variable can be easily bounded [Bou07, Proposition 3.1]. Moreover, we know, by Corollary 8.10, that $N(\mathcal{P}) = 0$ on some affine subspaces of the space of variables. Unfortunately, these vanishing relations and its degree do not characterize $N(\mathcal{P})$ up to a multiplicative factor. Is there a bigger family of vanishing relations, linked to the combinatorics of the Hasse diagram of the poset, which characterizes $N(\mathcal{P})$?

This question comes from the following observation : for some particular posets, the numerator is a Schubert polynomial and Schubert polynomials are known to be easily defined by vanishing conditions [Las08a].

8.1.4 Outline of the paper

In section 8.2, we present some basic definitions on graphs and posets.

In section 8.3, we introduce our main object and its basic properties.

In section 8.4, we state our first main result : an inductive relation for linear extensions. The next section (8.5) is devoted to some explicit computations using this result.

Section 8.6 gives a combinatorial description of the result of the iteration of our inductive relation : we derive from it our second main result, a combinatorial formula for the numerator of $\Psi_{\mathcal{P}}$.

The last Section (8.7) is devoted to our third main result : a sufficient condition of factorization.

8.2 Graphs and posets

Oriented graphs are a natural way to encode information of posets. To avoid confusions, we recall all necessary definitions in paragraph 8.2.1. The definition of linear extensions can be easily formulated directly in terms of graphs (paragraph 8.2.2).

We will also define some elementary removal operations on graphs (paragraph 8.2.3), which will be used in the next section. Due to transitivity relations, it is not equivalent to perform these operations on the Hasse diagram or on the complete graph of a poset, that's why we prefer to formulate everything in terms of graphs.

8.2.1 Definitions and notations on graphs

In this paper, we deal with finite *directed graphs*. So we will use the following definition of a graph G :

- A finite set of vertices V_G .
- A set of edges E_G defined by $E_G \subset V_G \times V_G$.

If $e \in E_G$, we will note by $\alpha(e) \in V_G$ the first component of e (called *origin* of e) and $\omega(e) \in V_G$ its second component (called *end* of e). This means that each edge has an orientation.

Let $e = (v_1, v_2)$ be an element of $V_G \times V_G$. Then we denote by \bar{e} the pair (v_2, v_1) .

With this definition of graphs, we have four definitions of injective walks on the graph.

	can not go backwards	can go backwards
closed	circuit	cycle
non-closed	chain	path

More precisely,

Définition 8.1. Let G be a graph and E its set of edges.

chain : A chain is a sequence of edges $c = (e_1, \dots, e_k)$ of G such that $\omega(e_1) = \alpha(e_2)$, $\omega(e_2) = \alpha(e_3)$, ... and $\omega(e_{k-1}) = \alpha(e_k)$.

circuit : A circuit is a chain (e_1, \dots, e_k) of G such that $\omega(e_k) = \alpha(e_1)$.

path : A path is a sequence (e_1, \dots, e_k) of elements of $E \cup \bar{E}$ such that $\omega(e_1) = \alpha(e_2)$, $\omega(e_2) = \alpha(e_3)$, ... and $\omega(e_{k-1}) = \alpha(e_k)$.

cycle : A cycle C is a path with the additional property that $\omega(e_k) = \alpha(e_1)$. If C is a cycle, then we denote by $E(C)$ the set $C \cap E$.

In all these definitions, we add the condition that all edges and vertices are different (except of course, the equalities in the definition).

Remark. The difference between a cycle and a circuit (respectively a path and a chain) is that, in a cycle (respectively in a path), an edge can appear in both directions (not only in the direction given by the graph structure). The edges, which appear in a cycle C with the same orientation than their orientation in the graph, are exactly the elements of $E(C)$.

To make the figures easier to read, $\alpha(e)$ is always the left-most extremity of e and $\omega(e)$ its right-most one. Such drawing construction is not possible if the graph contains a circuit. But its case will not be very interesting for our purpose.

Example. An example of graph is drawn on figure 8.3. In the left-hand side, the non-dotted edges form a chain c , whereas, in the right-hand side, they form a cycle C , such that $E(C)$ contains 3 edges : $(1, 6)$, $(6, 8)$ and $(5, 7)$.

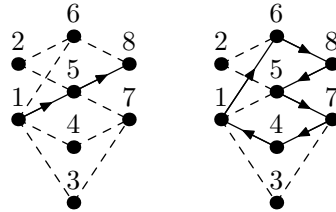

FIG. 8.3 – Example of a chain and a cycle C (we recall that orientations are from left to right).

The *cyclomatic number* of a graph G is $|E_G| - |V_G| + c_G$, where c_G is the number of connected components of G . A graph contains a cycle if and only if its cyclomatic number is not 0 (see [Die05]). If it is not the case, the graph is called *forest*. A connected forest is, by definition, a tree. Beware that, in this context, there are no rules for the orientation of the edges of a tree (often, in the literature, an oriented tree is a tree which edges are oriented from the *root* to the *leaves*, but we do not consider such objects here).

8.2.2 Posets, graphs, Hasse diagrams and linear extensions

In this paragraph, we recall the link between graphs and posets.

Given a graph G , we can consider the binary relation on the set V_G of vertices of G :

$$x \leq y \stackrel{\text{def}}{\iff} \left(x = y \text{ or } \exists e \in E_G \text{ such that } \begin{cases} \alpha(e) = x \\ \omega(e) = y \end{cases} \right)$$

This binary relation can be completed by transitivity. If the graph has no circuit, the resulting relation \leq is antisymmetric and, hence, endows the set V_G with a poset structure, which will be denoted $\text{poset}(G)$.

The application poset is not injective. Among the pre-images of a given poset \mathcal{P} , there is a minimum one (for the inclusion of edge set), which is called Hasse diagram of \mathcal{P} .

The definition of linear extensions given in the introduction can be formulated in terms of graphs :

Définition 8.2. A linear extension of a graph G is a total order \leq_w on the set of vertices V such that, for each edge e of G , one has $\alpha(e) \leq_w \omega(e)$.

The set of linear extensions of G is denoted $\mathcal{L}(G)$. Let us also define the formal sum $\Phi(G) = \sum_{w \in \mathcal{L}(G)} w$.

We will often see a total order \leq_w defined by $v_{i_1} \leq_w v_{i_2} \leq_w \dots \leq_w v_{i_n}$ as a word $w = v_{i_1} v_{i_2} \dots v_{i_n}$.

Remark. If G contains a circuit, then it has no linear extensions. Else, its linear extensions are the linear extensions of $\text{poset}(G)$. Thus considering graphs instead of posets does not give more general results.

The following lemma comes straight forward from the definition :

Lemma 8.1. *Let G and G' be two graphs with the same set of vertices. Then one has :*

$$E(G) \subset E(G') \text{ and } w \in \mathcal{L}(G') \implies w \in \mathcal{L}(G);$$

$$w \in \mathcal{L}(G) \text{ and } w \in \mathcal{L}(G') \iff w \in \mathcal{L}(G \vee G'),$$

where $G \vee G'$ is defined by $\begin{cases} V(G \vee G') = V(G) = V(G'); \\ E(G \vee G') = E(G) \cup E(G'). \end{cases}$

8.2.3 Elementary operations on graphs

The main tool of this paper consists in removing some edges of a graph G .

Définition 8.3. Let G be a graph and E' a subset of its set of edges E_G . We will denote by $G \setminus E'$ the graph G' with

- the same set of vertices as G ;
- the set $E_{G'} := E_G \setminus E'$ as set of edges.

Définition 8.4. If G is a graph and V' a subset of its set of vertices V , V' has an induced graph structure : its edges are exactly the edges of G , which have both their extremities in V' .

If $V \setminus V' = \{v_1, \dots, v_l\}$, this graph will be denoted by $G \setminus \{v_1, \dots, v_l\}$. The symbol is the same than in definition 8.3, but it should not be confusing.

Définition 8.5 (Contraction). We denote by G/e the graph (here, the set of edges can be a multiset) obtained by contracting the edge e (*i.e.* in G/e , there is only one vertex v instead of v_1 and v_2 , the edges of G different from e are edges of G/e : if their origin and/or end in G is v_1 or v_2 , it is v in G/e).

Then, if $\alpha(e) \neq \omega(e)$, G/e is a graph with the same number of connected components and the same cyclomatic number as G .

8.3 Rational functions on graphs

8.3.1 Definition

Given a graph G with n vertices v_1, \dots, v_n , we are interested in the following rational function $\Psi(G)$ in the variables $(x_{v_i})_{i=1\dots n}$:

$$\Psi(G) = \sum_{w \in \mathcal{L}(G)} \frac{1}{(x_{w_1} - x_{w_2}) \dots (x_{w_{n-1}} - x_{w_n})}.$$

We also consider the renormalization :

$$N(G) := \Psi(G) \cdot \prod_{e \in E_G} (x_{\alpha(e)} - x_{\omega(e)}).$$

In fact, we will see later that it is a polynomial. Moreover, if G is the Hasse diagram of a poset, $\Psi(G) = \frac{N(G)}{\prod_{e \in E_G} (x_{\alpha(e)} - x_{\omega(e)})}$ is a reduced fraction.

8.3.2 Pruning invariance

Thanks to the following lemma, it will be easy to compute N on forests (note that these results have already been proved in [Bou07], but the demonstrations here are simpler and make this article self-contained).

Lemma 8.2. *Let G be a graph with a vertex v of valence 1 and e the edge of extremity (origin or end) v . Then one has*

$$N(G) = N(G \setminus \{v\}).$$

Proof. One wants to prove that :

$$(x_{\alpha(e)} - x_{\omega(e)}) \cdot \left(\sum_{w' \in \mathcal{L}(G)} \psi_{w'} \right) = \sum_{w \in \mathcal{L}(G \setminus \{v\})} \psi_w.$$

But one has a map $\text{er}_v : \mathcal{L}(G) \rightarrow \mathcal{L}(G \setminus \{v\})$ which sends a word w' to the word w obtained from w' by erasing the letter v . So it is enough to prove that, for each $w \in \mathcal{L}(G \setminus \{v\})$, one has :

$$(x_{\alpha(e)} - x_{\omega(e)}) \cdot \left(\sum_{w' \in \text{er}_v^{-1}(w)} \psi_{w'} \right) = \psi_w.$$

Let us assume that v is the end of e and $w = w_1 \dots w_{n-1} \in \mathcal{L}(G \setminus \{v\})$. We denote by k the index in w of the origin of e . The set $\text{er}_v^{-1}(w)$ is :

$$\{w_1 \dots w_i v w_{i+1} \dots w_{n-1}, i \geq k\}$$

So, one has :

$$\begin{aligned} \text{So } \sum_{w' \in \text{er}_v^{-1}(w)} \psi_{w'} &= \sum_{i=k}^{n-1} \frac{1}{\left[(w_1 - w_2) \dots (w_{i-1} - w_i)(w_i - v) \right.} \\ &\quad \left. \cdot (v - w_{i+1})(w_{i+1} - w_{i+2}) \dots (w_{n-2} - w_{n-1}) \right]} \\ &= \frac{1}{(w_1 - w_2) \dots (w_{i-1} - w_i)(w_i - w_{i+1})(w_{i+1} - w_{i+2}) \dots (w_{n-2} - w_{n-1})} \\ &\quad \cdot \left[\sum_{i=k}^{n-2} \left(\frac{1}{v - w_{i+1}} - \frac{1}{w_i - v} \right) + \frac{1}{w_{n-1} - v} \right] \\ &= \frac{1}{(w_1 - w_2) \dots (w_{n-2} - w_{n-1})} \frac{1}{v - w_k} \\ &= \psi_w \cdot \frac{1}{x_{\alpha(e)} - x_{\omega(e)}} \end{aligned}$$

The computation is similar if v is the origin of e . □

8.3.3 Value on forests

One can now compute the value of N on forests. This result is essential in the following sections because we will often make proofs by induction on the cyclomatic number.

Proposition 8.3. *If T is a tree and F a disconnected forest, one has :*

$$N(T)=1; \tag{153}$$

$$N(F)=0. \tag{154}$$

Proof. Thanks to the pruning Lemma 8.2, we only have to prove it in the case where F is a disjoint union of n points. If $n = 1$, it is obvious that $N(\cdot) = \Psi(\cdot) = 1$. Else, if we denote by c the full cycle $(1 \dots n)$, one has :

$$\begin{aligned} \Psi(F) &= \sum_{\sigma \in S(n)} \frac{1}{(x_{\sigma(1)} - x_{\sigma(2)}) \dots (x_{\sigma(n-1)} - x_{\sigma(n)})} \\ &= \frac{1}{n} \sum_{\sigma \in S(n)} \sum_{i=0}^{n-1} \frac{1}{(x_{\sigma \circ c^i(1)} - x_{\sigma \circ c^i(2)}) \dots (x_{\sigma \circ c^i(n-1)} - x_{\sigma \circ c^i(n)})} \\ &= \frac{1}{n} \sum_{\sigma \in S(n)} \frac{\sum_{i=0}^{n-1} x_{\sigma \circ c^i(n)} - x_{\sigma \circ c^i(1)}}{(x_{\sigma(1)} - x_{\sigma(2)}) \dots (x_{\sigma(n-1)} - x_{\sigma(n)})(x_{\sigma(n)} - x_{\sigma(1)})} \\ &= 0. \end{aligned}$$

□

8.4 The main transformation

In the section 8.2, we have defined a simple operation on graphs consisting in removing edges. Thanks to this operation, we will be able to construct an operator which lets invariant the formal sum of linear extensions (paragraph 8.4.1). Due to the definition of Ψ , this implies immediately an inductive relation on the rational functions Ψ_G (paragraph 8.4.2).

8.4.1 Equality on linear extensions

In this paragraph, we prove an induction relation on the formal sums of linear extensions of graphs. More exactly, we write, for any graph G with at least one cycle, $\Phi(G)$ as a linear combination of $\Phi(G')$, where G' runs over graphs with a strictly lower cyclomatic number. In the next paragraphs, we will iterate this relation and apply Ψ to both sides of the equality to study Ψ_G .

If G is a finite graph and C a cycle of G , let us denote by $T_C(G)$ the following formal alternate sum of subgraphs of G :

$$T_C(G) = \sum_{\substack{E' \subset E(C) \\ E' \neq \emptyset}} (-1)^{|E'|-1} G \setminus E'.$$

The function $\Phi(G) = \sum_{w \in \mathcal{L}(G)} w$ can be extended by linearity to the free abelian group spanned by graphs. One has the following theorem :

Theorem 8.4. *Let G be a graph and C a cycle of G . Then,*

$$\Phi(G) = \Phi(T_C(G)). \tag{155}$$

Note that all graphs appearing in the right-hand side of (155) have strictly less cycles than G . An example is drawn on figure 8.4 (to make it easier to read, we did not write the operator Φ in front of each graph).

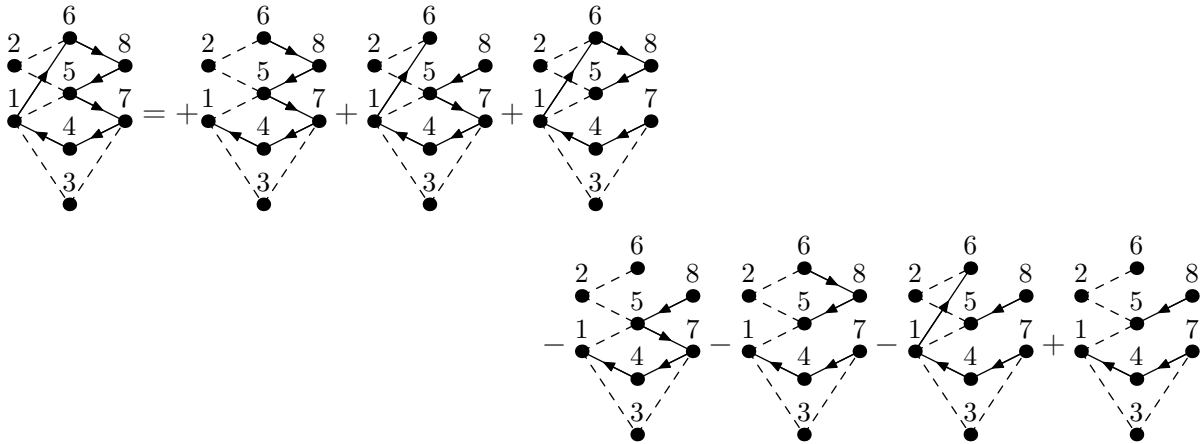

FIG. 8.4 – Example of application of theorem 8.4

Remark. In the case where $E(C) = \emptyset$, this theorem says that graphs with oriented circuits have no linear extensions (see remark 8.2.2).

If it is a singleton, it says that we do not change the set of linear extensions by erasing an edge if there is a path going from its origin to its end (thanks to transitivity).

An other very interesting case of our relation is the following one. Let G be a graph and v_1 and v_2 two vertices of G which are not linked by an edge. We can write

$$\Phi(G) = \sum_{\substack{w \in \mathcal{L}(G) \\ v_1 \leq_w v_2}} w + \sum_{\substack{w \in \mathcal{L}(G) \\ v_2 \leq_w v_1}} w \tag{156}$$

This is in fact a special case of our relation on the graph G' obtained from G by adding two edges $e_{1,2} = (v_1, v_2)$ and $e_{2,1} = (v_2, v_1)$. This graph contains a circuit so $\Phi(G') = 0$. But one also has :

$$\Phi(G') = \Phi(G \cup \{e_{1,2}\}) + \Phi(G \cup \{e_{2,1}\}) - \Phi(G).$$

So $\Phi(G)$ is the sum of two terms corresponding exactly to equation (156). By iterating this equality, deleting graph with circuits and erasing edges thanks to transitivity relation, we obtain :

$$\Phi(G) = \sum_{w \in \mathcal{L}(G)} \Phi(\overset{w_1}{\bullet} \xrightarrow{w_2} \dots \xrightarrow{w_{n-1}} \overset{w_n}{\bullet}).$$

An immediate consequence is that any relation between the $\Phi(G)$ can be deduced from Theorem 8.4.

To prove Theorem 8.4, we will need the two following lemma :

Lemma 8.5. *Let $w \in \mathcal{L}(G \setminus E(C))$. There exists $E'(w)$ such that*

$$\forall E'' \subset E(C), \quad w \in \mathcal{L}(G \setminus E'') \iff E'(w) \subset E'' \subset E(C).$$

Proof. immediate consequence of lemma 8.1. □

Lemma 8.6. *Let $w \in \mathcal{L}(G \setminus E(C))$, there exists $E'' \subsetneq E(C)$ such that*

$$w \in \mathcal{L}(G \setminus E'').$$

Proof. Suppose that we can find a word w for which the lemma is false. Since $w \in \mathcal{L}(G \setminus E(C))$, the word w fulfills the relations of the edges of C , which are not in $E(C)$.

But, if $e \in E(C)$, one has $w \notin \mathcal{L}(G \setminus (E(C) \setminus \{e\}))$. That means that w does not fulfill the relation corresponding to the edge e . As w is a total order, it fulfills the opposite relation :

$$w \in \mathcal{L} \left[(G \setminus E(C)) \cup \bar{e} \right].$$

Doing the same argument for each $e \in E(C)$, one has

$$w \in \mathcal{L} \left[(G \setminus E(C)) \cup \overline{E(C)} \right].$$

But this graph contains an oriented cycle so the corresponding set of linear extension is empty. □

Let us come back to the proof of Theorem 8.4.

Let w be a word containing exactly once each element of $V(G)$. We will compute its coefficient in $\Phi(G) - \Phi(T_C(G)) = \sum_{E' \subset E(C)} (-1)^{|E'|} \Phi(G \setminus E')$:

- If $w \notin \mathcal{L}(G \setminus E(C))$, its coefficient is zero in each summand.
- If $w \in \mathcal{L}(G \setminus E(C))$, thanks Lemma 8.5, we know that there exists $E'(w) \subset E(C)$ such that

$$w \in \mathcal{L}(G \setminus E'') \iff E'(w) \subset E'' \subset E(C).$$

So the coefficient of w in $\Phi(G) - \Phi(T_C(G))$ is

$$\sum_{E'(w) \subset E'' \subset E(C)} (-1)^{|E''|} = 0 \text{ (because } E'(w) \neq E(C), \text{ Lemma 8.6).}$$

8.4.2 Consequences on Greene functions

In the previous paragraph, we have established an induction formula for the formal sum of linear extensions (Theorem 8.4). One can apply Ψ to both sides of this equality to compute $N(G)$:

Proposition 8.7. *Let G be the graph containing a cycle C . Then,*

$$N(G) = \sum_{\substack{E' \subset E(C) \\ E' \neq \emptyset}} \left[(-1)^{|E'|-1} N(G \setminus E') \prod_{e \in E'} (x_{\alpha(e)} - x_{\omega(e)}) \right].$$

By Proposition 8.3, one has $N(T) = 1$ if T is a tree and $N(F) = 0$ if F is a disconnected forest. So this Proposition gives us an algorithm to compute $N(G)$: we just have to iterate it with any cycles until all the graphs in the right hand side are forests. More precisely, if after iterating transformations of type T_C on G , we obtain the formal linear combination $\sum c_F F$ of subforests of G , then :

$$N(G) = \sum_{T \text{ subtree of } G} c_T \prod_{e \in E_G \setminus E_T} (x_{\alpha(e)} - x_{\omega(e)}).$$

In this formula, $N(G)$ appears as a sum of polynomials. So the computation of $N(G)$, using this formula, is easier than a direct application of the definition

$$N(G) = \sum_{w \in \mathcal{L}(G)} \left(\Psi_w \cdot \prod_{e \in E_G} (x_{\alpha(e)} - x_{\omega(e)}) \right),$$

where the summands may have poles.

We will use this algorithm in the next section on some examples. But it has also a theoretical interest : some properties of N on forests can be immediately extended to any graph.

Corollary 8.8. *For any graph G , the rational function $N(G)$ is a polynomial. Moreover, if G is disconnected, $N(G) = 0$.*

In fact, if G is the Hasse diagram of a connected poset, the fraction $\Psi(G) = \frac{N(G)}{\prod_{e \in E_G} (x_{\alpha(e)} - x_{\omega(e)})}$ is irreducible (see [Bou07] for a proof of this fact).

The following result can also be proved by induction on the cyclomatic number :

Proposition 8.9. *Let G be a graph and e an edge of G between two vertices v_1 and v_2 . Then*

$$N(G/e) = N(G) \Big|_{x_{v_1} = x_{v_2} = x_v},$$

where v is the contraction of v_1 and v_2 in G/e .

Proof (by induction on the cyclomatic number of G). If G is a forest, then the equality is obvious by Proposition 8.3.

If G/e contains a cycle C_e , then we consider the following cycle C in G :

- If C_e does not go through the vertex v (contraction of v_1 and v_2), then C_e can also be seen as a cycle C of G .
- Suppose that v is the end of e_i and the origin of e_{i+1} and that they are also the same vertex (v_1 or v_2) in G . Then, C_e can still be seen as a cycle C of G .
- Suppose that v is the end of e_i and the origin of e_{i+1} but that these two edges have different extremities (v_1 and v_2) in G . Then we add the edge e or \bar{e} to C_e (between e_i and e_{i+1}) to obtain a cycle C of G .

Eventually by changing the orientations of C_e and C , we can assume that $e \notin E(C)$ and, as a consequence $E(C) = E(C_e)$. By theorem 8.7, one has :

$$N(G/e) = \sum_{\substack{E' \subset E(C_e) \\ E' \neq \emptyset}} (-1)^{|E'|-1} N((G/e) \setminus E'). \prod_{e \in E'} (x_{\alpha(e)} - x_{\omega(e)})$$

$$N(G) = \sum_{\substack{E' \subset E(C) \\ E' \neq \emptyset}} (-1)^{|E'|-1} N(G \setminus E'). \prod_{e \in E'} (x_{\alpha(e)} - x_{\omega(e)}).$$

As $e \notin E(C)$,

$$(G \setminus E')/e = (G/e) \setminus E' \quad \text{and} \quad E(C_e) = E(C).$$

This ends the proof by applying the induction hypothesis to the graphs $G \setminus E'$. \square

Another immediate consequence of Proposition 8.7 is the following vanishing property of $N(G)$.

Corollary 8.10. *Let G be a graph. Let C be a cycle of G with $E(C) = \{e_1, \dots, e_r\}$. One has*

$$N(G)|_{x_{\alpha(e_i)}=x_{\omega(e_i)}, i=1 \dots r} = 0$$

Unfortunately, this corollary, written for every cycle of a graph G , does not characterize $N(G)$ up to a multiplicative factor (see paragraph 8.1.3.3).

8.5 Some explicit computations of rational functions

This section is devoted to some examples of explicit computation of $N(G)$ using the algorithm described in paragraph 8.4.2.

8.5.1 Graphs with cyclomatic number 1.

We consider in this paragraph connected graphs G with $|V_G| = |E_G|$. Using pruning Lemma 8.2, we can suppose that each vertex of G has valence 2. We denote by $\max(G)$ (resp. $\min(G)$) the set of maximal (resp. minimal) elements of G . The following result was already proved in [Bou07], but we present here a simpler proof using the results of the previous section.

Proposition 8.11. *If G is a connected graph with vertices of valence 2, then*

$$N(G) = \sum_{v \in \min G} x_v - \sum_{v' \in \max(G)} x_{v'}.$$

Proof. G has only one cycle C (we only have to choose an orientation). In the right-hand side of equation (155), we have two kinds of terms :

- If $|E'| = 1$, $G \setminus E'$ is a tree and $N(G \setminus E') = 1$.
- If $|E'| > 1$, $G \setminus E'$ is disconnected and $N(G \setminus E') = 0$.

Then

$$N(G) = \sum_{e \in E(C)} (x_{\alpha(e)} - x_{\omega(e)}).$$

The sum above can be simplified and is equal to $\sum_{v \in \min G} x_v - \sum_{v' \in \max(G)} x_{v'}$. □

Example.

$$N \left(\begin{array}{c} \bullet \\ \diagup \quad \diagdown \\ \bullet \quad \bullet \\ \diagdown \quad \diagup \\ \bullet \end{array} \right) = (x_1 - x_3) N \left(\begin{array}{c} \bullet \\ \diagup \quad \diagdown \\ \bullet \quad \bullet \\ \diagdown \quad \diagup \\ \bullet \end{array} \right) + (x_2 - x_4) N \left(\begin{array}{c} \bullet \\ \diagup \quad \diagdown \\ \bullet \quad \bullet \\ \diagdown \quad \diagup \\ \bullet \end{array} \right) \tag{157}$$

$$+ (x_4 - x_5) N \left(\begin{array}{c} \bullet \\ \diagup \quad \diagdown \\ \bullet \quad \bullet \\ \diagdown \quad \diagup \\ \bullet \end{array} \right) \pm N \left(\begin{array}{c} \text{disconnected} \\ \text{graphs} \end{array} \right) \tag{158}$$

$$= (x_1 - x_3) + (x_2 - x_4) + (x_4 - x_5) \tag{159}$$

$$= x_1 + x_2 - x_3 - x_5. \tag{160}$$

8.5.2 Graphs with cyclomatic number 2.

Let G be a connected graph with a cyclomatic number equal to 2. Thanks to pruning Lemma 8.2, we can assume that G has no vertices of valence 1. As $|E_G| = |V_G| + 1$, the graph has, in addition of vertices of valence 2, either two vertices of valence 3 or one vertex of valence 4. We will only look here at the case where there are two vertices v and v' of valence 3 and the edges can be partitioned into three paths p_0 , p_1 and p_2 from v to v' (the other cases are easier because the cycles have no edges in common).

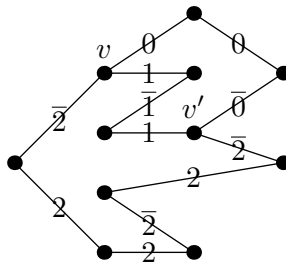

FIG. 8.5 – Example of a graph G with cyclomatic number 2.

For $i = 0, 1, 2$, let us denote by E_i (resp. by $E_{\bar{i}}$) the set of edges of the path p_i which appear in the same (resp. opposite) orientation in the graph and in the path p_i (see the figure 8.5 for an example, we have written on each edge the index of the set it belongs to). If $I = \{i_1, \dots, i_l\} \subset \{0, 1, 2, \bar{0}, \bar{1}, \bar{2}\}$, we consider the following alternate sum of graphs :

$$G_I = \sum_{\emptyset \neq E'_1 \subset E_{i_1}, \dots, \emptyset \neq E'_l \subset E_{i_l}} (-1)^{|E'_1|-1} \dots (-1)^{|E'_l|-1} G \setminus (E'_1 \cup \dots \cup E'_l).$$

Let us consider the cycle $C = \bar{p}_1 \cdot p_2$: one has $E(C) = E_{\bar{1}} \cup E_2$. The subsets of $E(C)$ can be partitioned in three families :

- that included in $E_{\bar{1}}$;
- that included in E_2 ;
- the unions of a subset of $E_{\bar{1}}$ and a subset of E_2 .

Thus, if we apply Theorem 8.4 with respect to C , we obtain :

$$\Phi(G) = \Phi(G_{\bar{1}}) + \Phi(G_2) - \Phi(G_{2, \bar{1}}).$$

Each graph in $G_{\bar{1}}$ contains the cycle $\bar{p}_0 \cdot p_2$, because only edges belonging to p_1 have been removed. If we apply Theorem 8.4 with this cycle, we obtain :

$$\begin{aligned} \Phi(G_{\bar{1}}) &= \sum_{E' \subset E_{\bar{1}}} (-1)^{|E'|-1} \Phi(G \setminus E') \\ &= \sum_{E' \subset E_{\bar{1}}} (-1)^{|E'|-1} \left(\sum_{E'' \subset E_{\bar{0}}} (-1)^{|E''|-1} \Phi((G \setminus E') \setminus E'') \right. \\ &\quad \left. + \sum_{E'' \subset E_2} (-1)^{|E''|-1} \Phi((G \setminus E') \setminus E'') \right. \\ &\quad \left. - \sum_{\substack{E'' \subset E_2 \\ E''' \subset E_{\bar{0}}}} (-1)^{|E''|-1} (-1)^{|E'''|-1} \Phi((G \setminus E') \setminus (E'' \cup E''')) \right) \\ &= \Phi(G_{\bar{0}, \bar{1}}) + \Phi(G_{2, \bar{1}}) - \Phi(G_{2, \bar{0}, \bar{1}}) \end{aligned}$$

In a similar way, all graphs in G_2 contains the cycle $p_1 \cdot \bar{p}_0$ and one has $\Phi(G_2) = +\Phi(G_{2, \bar{0}}) + \Phi(G_{1, 2}) - \Phi(G_{1, 2, \bar{0}})$. The graphs in $G_{2, \bar{1}}$ have no cycles, so, finally :

$$\begin{aligned} \Phi(G) &= \Phi(G_{\bar{0}, \bar{1}}) + \Phi(G_{2, \bar{1}}) - \Phi(G_{2, \bar{0}, \bar{1}}) \\ &\quad + \Phi(G_{2, \bar{0}}) + \Phi(G_{1, 2}) - \Phi(G_{1, 2, \bar{0}}) - \Phi(G_{2, \bar{1}}); \\ &= \Phi(G_{\bar{0}, \bar{1}}) - \Phi(G_{2, \bar{0}, \bar{1}}) + \Phi(G_{2, \bar{0}}) + \Phi(G_{1, 2}) - \Phi(G_{1, 2, \bar{0}}). \end{aligned}$$

If we apply Ψ to this equality, we keep only connected graphs and obtain :

$$\Psi(G) = \Psi(G'_{\bar{0}, \bar{1}}) + \Psi(G'_{2, \bar{0}}) + \Psi(G'_{1, 2}),$$

where $G'_I = \sum_{e_1 \in E_{i_1}, \dots, e_l \in E_{i_l}} G \setminus \{e_1, \dots, e_l\}$. As all graphs in the expression of G'_I are trees, we obtain (by using X_e instead of $x_{\alpha(e)} - x_{\omega(e)}$) :

$$\begin{aligned} N(G) &= \sum_{e_{\bar{0}} \in E_{\bar{0}}, e_{\bar{1}} \in E_{\bar{1}}} X_{e_{\bar{0}}} \cdot X_{e_{\bar{1}}} + \sum_{e_{\bar{0}} \in E_{\bar{0}}, e_2 \in E_2} X_{e_{\bar{0}}} \cdot X_{e_2} + \sum_{e_1 \in E_1, e_2 \in E_2} X_{e_1} \cdot X_{e_2} \\ &= \left(\sum_{e_{\bar{0}} \in E_{\bar{0}}} X_{e_{\bar{0}}} \right) \left(\sum_{e_{\bar{1}} \in E_{\bar{1}}} X_{e_{\bar{1}}} \right) + \left(\sum_{e_{\bar{0}} \in E_{\bar{0}}} X_{e_{\bar{0}}} \right) \left(\sum_{e_2 \in E_2} X_{e_2} \right) \\ &\quad + \left(\sum_{e_1 \in E_1} X_{e_1} \right) \left(\sum_{e_2 \in E_2} X_{e_2} \right). \end{aligned}$$

One can notice that, if $E_{\bar{0}}$ is empty (that is to say that there is a chain from v to v'), the polynomial $N(G)$ is the product of two polynomials on degree 1. This is a particular case of our third main result (Theorem 8.18).

8.5.3 Simple bipartite graphs

Définition 8.6. A graph is said to be bipartite if its set of vertices can be partitioned in two sets V_1 and V_2 such that $E \subset V_1 \times V_2$.

Moreover, a bipartite graph is said complete if $E = V_1 \times V_2$.

In this section we will look at bipartite graphs G such that $|V_1| = 2$. Thanks to the pruning Lemma 8.2, we can suppose that G is a complete bipartite graph. The complete bipartite graph with $|V_1| = 2$ and $|V_2| = n$ is unique up to isomorphism and will be denoted $G_{2,n}$.

Proposition 8.12. *Let us call a_1, a_2 (resp. b_1, \dots, b_n) the variables associated to the vertices v_1^1 and v_1^2 of V_1 (resp. $(v_2^i)_{1 \leq i \leq n}$ of V_2). Then one has :*

$$N(G_{2,n}) = \sum_{i=1}^n \left(\prod_{j < i} (b_j - a_1) \cdot \prod_{k > i} (b_k - a_2) \right).$$

Proof. For each $h = 1, 2$ and $i = 1, \dots, n$, we denote by $e_{h,i}$ the edge (v_1^h, v_2^i) . We will show, by induction of n , that, by applying several times theorem 8.4, we obtain the following equality (which is drawn on figure 8.6 for $n = 4$; we omit the Φ for clearness) :

$$\begin{aligned} \Phi(G_{2,n}) &= \sum_{i=1}^n \Phi(G_{2,n} \setminus \{e_{2,1}, \dots, e_{2,i-1}, e_{1,i+1}, \dots, e_{1,n}\}) \\ &\quad - \sum_{i=1}^{n-1} \Phi(G_{2,n} \setminus \{e_{2,1}, \dots, e_{2,i}, e_{1,i+1}, \dots, e_{1,n}\}). \end{aligned} \quad (161)$$

For $n = 1$, the statement is obvious. Let us suppose that our formula is true for n and that the equality at rank n is obtained by an iterated application of Theorem 8.4 in the graph

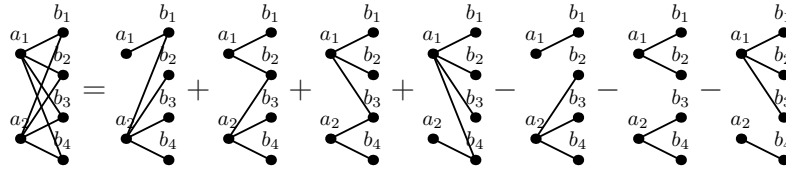

FIG. 8.6 – Decomposition of $\Phi(G_{2,4})$.

$G_{2,n}$. We can do the same transformations in $G_{2,n+1}$ (which contains canonically $G_{2,n}$). We obtain :

$$\Phi(G_{2,n+1}) = \sum_{i=1}^n \Phi(G_{2,n+1} \setminus \{e_{2,1}, \dots, e_{2,i-1}, e_{1,i+1}, \dots, e_{1,n}\}) - \sum_{i=1}^{n-1} \Phi(G_{2,n+1} \setminus \{e_{2,1}, \dots, e_{2,i}, e_{1,i+1}, \dots, e_{1,n}\}) \quad (162)$$

The graphs of the first line have still one cycle $(e_{2,i}, \overline{e_{1,i}}, e_{1,n+1}, \overline{e_{2,n+1}})$. By Theorem 8.4, one has :

$$\begin{aligned} \Phi(G_{2,n+1} \setminus \{e_{2,1}, \dots, e_{2,i-1}, e_{1,i+1}, \dots, e_{1,n}\}) = & \\ & \Phi(G_{2,n+1} \setminus \{e_{2,1}, \dots, e_{2,i-1}, e_{2,i}, e_{1,i+1}, \dots, e_{1,n}\}) \\ & + \Phi(G_{2,n+1} \setminus \{e_{2,1}, \dots, e_{2,i-1}, e_{1,i+1}, \dots, e_{1,n}, e_{1,n+1}\}) \\ & - \Phi(G_{2,n+1} \setminus \{e_{2,1}, \dots, e_{2,i-1}, e_{2,i}, e_{1,i+1}, \dots, e_{1,n}, e_{1,n+1}\}). \end{aligned}$$

Using this formula for each i , the first summand balances with the negative term in (162) (except for $i = n$) and the two other summands are exactly what we wanted. This ends the induction and Formula (162) is true for any n .

Note that the graphs of its right hand side have no cycles and that only the ones of the first line are connected. We just have to apply Ψ to this equality, and use the value of Ψ on forests (Proposition 8.3) to finish the proof of the proposition. \square

Note that this case is interesting because the function N can be expressed as a specialization of a rectangular Schur function (see [Bou07, Proposition 4.2]).

Remark. Our algorithm allows us to write $\Phi(G)$ as a sum of terms of the kind $\pm\Phi(F)$, with F subforest of G . But, in the three examples of this section, all trees have 0 or +1 as coefficients after iteration of transformations of kind T_C on G . We will see in the next section that this is possible for any graph G with a clever choice of cycles.

8.6 A combinatorial formula for N

To compute the polynomial N associated to a graph G , we only have to find the coefficient of trees in a formal linear combination of forests obtained by iterating transformations

T_C on G . But there are many possible choices of cycles at each step and these coefficients depend on these choices.

A way to avoid this problem is to give to G a rooted map structure and to look at the particular decomposition introduced in the paper [Fér08a, section 3]. With these particular choices, we have a combinatorial description of the trees with coefficient $+1$, all other trees having 0 as coefficient.

8.6.1 Rooted maps and admissible cycles

Définition 8.7. A (combinatorial oriented) map is a connected graph with, for each vertex v , a cyclic order on the edges whose origin or end is v . This definition is natural when the graph is drawn on a two dimensional surface (see for example [Tut63]).

It is more convenient when we deal with maps, to consider edges as couples of two half-edges (called darts) (h_1, h_2) , the first one of extremity $\alpha(e)$ and the second one of extremity $\omega(e)$. Then the map structure is given by a permutation σ of all the darts, whose orbits correspond to the sets of darts with the same extremity.

A rooted map is a map with an external dart h_0 , that is to say a dart which do not belong to any edge, but has an extremity (which will be denoted by \star) and a place in the cyclic order given by this extremity.

Remark. In this section, as cyclic orders of edges around vertices matter, we can not use the convention that the extremity of an edge is always on its origin's right (we did not assume any condition on compatibility between the orientations of the edges and the map structure, see open problem 8.1.3.1).

Recall that, to compute $N(G)$, a naive algorithm is to choose any cycle of the graph, apply proposition 8.7. If the graph has a rooted map structure, it is interesting to choose cycles with additional properties. Our choices will not involve the orientation of the edges of the map. So we will define a notion of admissible cycle in a (not necessary oriented) rooted map.

By definition, a cycle C of a rooted map is admissible of type 1 (see figure 8.7) if :

- The vertex \star is a vertex of the cycle, that is to say that \star is the extremity of a dart h_i of e_i and of a dart h_{i+1} of e_{i+1} for some i ;
- The cyclic order at \star restricted to the set $\{h_0, h_i, h_{i+1}\}$ is the cyclic order (h_0, h_{i+1}, h_i) .

If C satisfies the first condition, exactly one cycle among C and \overline{C} is admissible (where \overline{C} is C with the opposite orientation).

If a rooted map has no admissible cycles of type 1, it is of the form of the figure 8.8. In this case, we call admissible cycles of type 2 the admissible cycles of its "legs" M_1, \dots, M_h (of type 1 or 2, this defines the admissible cycles by induction). Note that this definition has a sense because the legs have a canonical external dart and are rooted maps. An example of

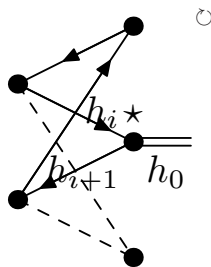

FIG. 8.7 – Example of a map M with an admissible cycle of type 1.

an admissible cycle of type 2 is drawn on Figure 8.9

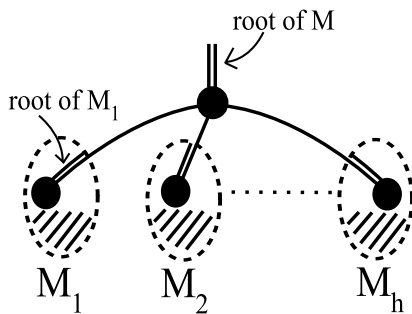

FIG. 8.8 – A generic map M without admissible cycles of type 1

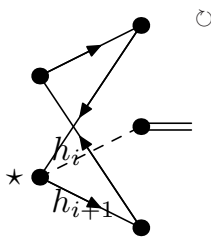

FIG. 8.9 – Example of a map M' with an admissible cycle of type 2.

A rooted map without admissible cycles has no cycles at all, hence it is a tree.

Remark. The second condition in the definition of admissible of type 1 says that the root must be at the left of the cycle. The first condition is only technical, because if the cycle does not go through \star , we can not define “to be on the left of the cycle”.

For a planar map this can be avoided because any cycle split the plan into two regions, so the left side of an oriented cycle is well-defined. In this case, we can call admissible any cycle

such that the root is at the left of the cycle even if the the cycle does not go through \star and the confluence of the algorithm in the next paragraph will still be true.

8.6.2 Decomposition of rooted maps

Consider the following algorithm :

Input : a rooted map M .

Variable : S is a formal linear combination of submap of M .

Initialization : $S = M$.

Iterated step : Choose a map M_0 with a non-zero coefficient c_{M_0} in S which is not a forest and C an admissible cycle of M_0 . Apply T_C to M_0 in S and keep only the connected graphs in the right-hand side (they have a natural induced rooted map structure). Formally,

$$S := S - c_{M_0}M_0 + c_{M_0}\delta(T_C(M_0)),$$

where δ is the linear operator defined by :

$$\delta(M') = \begin{cases} M' & \text{if } M' \text{ connected} \\ 0 & \text{else} \end{cases}.$$

End : We iterate this until S is a linear combination of subtrees of M .

Output : S .

Definition-Theorem 8.13. *This algorithm always terminates and is confluent. Let $D_c(M)$ be its output.*

Idea of the proof. The termination is obvious : all maps in $T_C(M_0)$ have a lower cyclomatic number than M_0 .

For the confluence, the maps whose graphs are considered in paragraph 8.5.2 play a similar role to critical peaks in rewriting theory. We just have to check our result on these maps. There are infinitely many maps of this kind, but, as in paragraph 8.5.2, one computation is enough to deal with the general case. \square

For a complete proof, see [Fér08a, definition-theorem 3.1.1 and 3.2.1, together with remark 2].

Proposition 8.14. *Let M be a rooted map.*

$$\Psi(D_c(M)) = \Psi(M)$$

Proof. We have to check that $\Psi(S)$ is an invariant of our algorithm. This is trivial because operators T_C and δ let Ψ invariant (see Theorem 8.4 and Proposition 8.8). \square

Example. Let M be the complete bipartite graph $G_{2,3}$ ($V_1 = \{a_1, a_2\}$, $V_2 = \{b_1, b_2, b_3\}$) with the following rooted map structure :

- If we denote by $e_{1,i}$ (resp $e_{2,i}$) the edge between a_1 (resp. a_2) and b_i , the cyclic order around the vertex a_1 (resp. a_2) is $(e_{1,1}, e_{1,2}, e_{1,3})$ (resp. $(e_{2,1}, e_{2,2}, e_{2,3})$).

- The root has extremity b_2 and is located before $e_{2,2}$.

The cycle $C = (e_{2,2}, e_{2,1}, e_{1,1}, e_{1,2})$ with $E(C) = \{e_{2,1}, e_{1,2}\}$ (drawn on Figure 8.7) is admissible (of type 1). So, with this choice, after the first iteration of step 1 of our decomposition algorithm, we have :

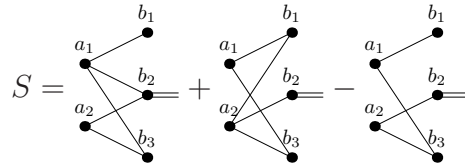

The two firsts graph have each an admissible cycle : the first one of type 1 ($C = (\overline{e_{2,2}}, e_{2,3}, \overline{e_{1,3}}, e_{1,2})$ with $E(C) = \{e_{2,3}, e_{1,2}\}$), the second one of type 2 ($C = (e_{2,3}, \overline{e_{1,3}}, e_{1,1}, \overline{e_{2,1}})$ and $E(C) = \{e_{2,3}, e_{1,1}\}$, see figure 8.9). So the algorithm ends after two other iterations and we obtain :

$$D_c(M) = \begin{array}{c} \bullet \\ \diagup \quad \diagdown \\ a_1 \quad b_1 \\ \diagdown \quad \diagup \\ \bullet \end{array} + \begin{array}{c} \bullet \\ \diagup \quad \diagdown \\ a_1 \quad b_1 \\ \diagdown \quad \diagup \\ \bullet \end{array} + \begin{array}{c} \bullet \\ \diagup \quad \diagdown \\ a_1 \quad b_1 \\ \diagdown \quad \diagup \\ \bullet \end{array} + \begin{array}{c} \bullet \\ \diagup \quad \diagdown \\ a_1 \quad b_1 \\ \diagdown \quad \diagup \\ \bullet \end{array} - \begin{array}{c} \bullet \\ \diagup \quad \diagdown \\ a_1 \quad b_1 \\ \diagdown \quad \diagup \\ \bullet \end{array} \tag{163}$$

$$= \begin{array}{c} \bullet \\ \diagup \quad \diagdown \\ a_1 \quad b_1 \\ \diagdown \quad \diagup \\ \bullet \end{array} + \begin{array}{c} \bullet \\ \diagup \quad \diagdown \\ a_1 \quad b_1 \\ \diagdown \quad \diagup \\ \bullet \end{array} + \begin{array}{c} \bullet \\ \diagup \quad \diagdown \\ a_1 \quad b_1 \\ \diagdown \quad \diagup \\ \bullet \end{array} \tag{164}$$

Note that, after cancellation, the coefficient of trees in $D_c(M)$ are 0 or +1. In the next paragraph we will show that it is true for any map M (the sign is a particular case of [Fér08a, Proposition 3.3.1]) and characterize combinatorially the trees with a coefficient +1.

8.6.3 Coefficients in $D_c(M)$

To compute the polynomial N , we only have to compute the coefficients of spanning trees in $D_c(M)$. In this section, we will link this coefficient with a combinatorial property of the tree T .

Définition 8.8. If T is a spanning subtree of a rooted map M , the tour of the tree T beginning at h_0 defines an order on the darts which do not belong to T . The definition is easy to understand on a figure : for example, on Figure 8.10, the tour is $(h_1^1, h_2^1, h_1^2, h_2^2, h_1^3, h_4^1, h_2^3, h_4^2)$. (see [Ber08] for a precise definition).

We recall that $D_c(M)$ does not depend on the admissible cycle chosen at step 1 of the decomposition algorithm. A good choice to compute the coefficient of a given spanning tree $T \subsetneq M$ is given by lemma 8.15. Given an edge e of $M \setminus T$, it is well-known that there exists a unique cycle (up to the orientation) denoted $C(e)$ such that $C(e) \subset (E_T \cup \{e\})$.

Lemma 8.15. *There exists an edge $e_0 \in M \setminus T$ such that, with the good orientation, $C(e_0)$ is admissible. Moreover,*

$$e_0 \in E(C(e_0)) \iff \begin{array}{l} \text{The first dart of } e_0 \text{ appears in} \\ \text{the tour of } T \text{ before the second one.} \end{array}$$

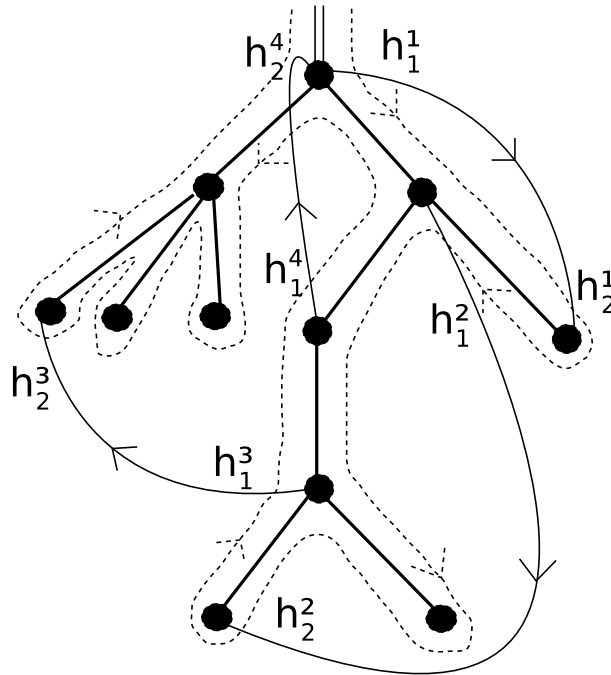

FIG. 8.10 – Tour of a spanning tree of a map.

Proof. The proof of the lemma, by induction on the size of M , can be divided in three cases :

1. If there is an edge e of $M \setminus T$ whose origin or end is \star (the extremity of the external dart), then \star is a vertex of the cycle $C(e)$ and either $C(e)$ or $\overline{C(e)}$ is admissible of type 1.
2. Else, let T_1, \dots, T_l be the connected component of $T \setminus \{\star\}$. If there is an edge e whose extremities are in two different T_i , then $C(e)$ is going through \star and e suits in the lemma.
3. Else, $M \setminus \{\star\}$ has as many connected components as $T \setminus \{\star\}$. Let us denote them by $M_i \supset T_i (1 \leq i \leq l)$. There exists an j , such that $M_j \supsetneq T_j$. In this case M has no admissible cycle of type 1, but by induction there exists $e \in M_j \setminus T_j$ such that $C_{M_j}(e)$ is admissible in M_j . By definition, this cycle is admissible of type 2 in M . But $C_{M_j}(e) = C_M(e)$, so the proof of the lemma is over.

The second part of the proof is easy in the two first cases (see figure 8.10). For the third one, it is again an immediate induction. \square

This helps us to compute all coefficients of trees in $D_c(M)$:

Proposition 8.16. *Let M be a rooted map and T a spanning tree of M .*

- *If there is an edge $e = (h_1, h_2) \in M \setminus T$ such that h_2 appears before h_1 in the tour of T , then the coefficient of T in $D_c(M)$ is 0.*
- *Else, the coefficient of T in $D_c(M)$ is +1 (T will be said good).*

For example, the spanning tree of Figure 8.10 is good. Note that the property of being a good spanning tree does not depend on the orientation of the edges of the tree, but only on

the orientation of those which do not belong to it (which is represented by arrows on Figure 8.10).

Proof. We will prove this proposition by induction over the number of edges in $M \setminus T$. If $M = T$, T is good and the result is obvious.

Let T be a covering tree of rooted map M such that $M \setminus T$ contains at least one element. We use lemma 8.15 and divide the proof in two cases :

Case $e_0 \notin E(C(e_0))$: In this case the spanning tree T can not be good. Besides, $E(C(e_0)) \subset T$, so every map appearing in $T_{C(e_0)}(M)$ does not contain T . But this remains true when we apply operators of kind T_C . In particular, the coefficient of T in $D_c(M)$ is 0.

Case $e_0 \in E(C(e_0))$: In this case, one has :

$$T_{C(e_0)}(M) = M \setminus \{e_0\} + \text{maps which do not contain } T.$$

$$\text{So } D_c(M) = D_c(M \setminus \{e_0\}) + \sum_{M' \not\supset T} D_c(M').$$

As in the previous case, the second summand has a contribution 0 to the coefficient of T in $D_c(M)$. By induction hypothesis, the first one has contribution +1 if T is a good spanning tree of $M \setminus \{e_0\}$ and 0 else. But, by definition of good spanning trees, it is immediate that :

$$T \text{ is a good spanning tree of } M. \iff \begin{array}{l} T \text{ is a good spanning tree of } M \setminus \{e_0\} \\ \text{and the first dart of } e_0 \text{ appears} \\ \text{before its second in the tour of } T. \end{array}$$

But as $e_0 \in E(C(e_0))$, the second condition of the right hand side is true by lemma 8.15. Finally, the coefficient of T is +1 if T is a good spanning subtree of M and 0 else. □

We are now ready to state our second main result : for this , we have to give a rooted map structure to our G . This is possible in multiple ways (choice of the map structure and of the place of the root).

Theorem 8.17. *The polynomial N associated to the underlying graph G of a rooted map M is given by the following combinatorial formula :*

$$N(G) = \sum_{\substack{T \text{ good spanning} \\ \text{tree of } M}} \left[\prod_{\substack{e \in E(G) \\ e \notin T}} (x_{\alpha(e)} - x_{\omega(e)}) \right]. \tag{165}$$

Proof. This is an immediate consequence of paragraph 8.4.2 and Proposition 8.16. □

Of course, the good spanning trees depend on the map structure chosen on the graph G . So the theorem implies that the right member does not depend on it, which is quite surprising.

8.7 A condition of factorization

8.7.1 Chain factorization

In the previous section, we have given an additive formula for the numerator of the reduced fraction Ψ_P . Greene formula for planar posets (see subsection 8.1.1) and the example of Figure 8.1 show that, in some cases, it can also be written as a product of non-trivial factors. In this paragraph, we give a simple graphical condition on a graph G , which implies the factorization of $N(G)$.

Then, in the next paragraph we prove that, although our condition is not a necessary condition (see open problem 8.1.3.2), it explains the fact that N is a product of degree 1 terms for planar posets.

Remark. In this section, we will assume that all the graphs are connected, have no circuits and no transitivity relation (an edge going from the beginning to the end of a chain). As the value of N on disconnected graphs is 0 and Hasse diagrams of posets always fulfill the two others assumptions, we do not lose in generality. This means that, if we consider a chain c , there is no edges between the vertices of the chain except of course the edges of the chain itself.

Let G be a graph, c a chain of G , V_c the set of vertices of c (including the origin and te end of the chain) and G_1, \dots, G_k be all the connected component of $G \setminus V_c$. The complete subgraphs $\overline{G}_i = G_i \cup V_c$ (for $1 \leq i \leq k$) will be called region of G . Consider, for example, the graph of Figure 8.11 and the chain $c = (1, 2, 13, 3, 4, 5, 6, 14)$. In this case, the graph $G \setminus V_c$ has four connected components.

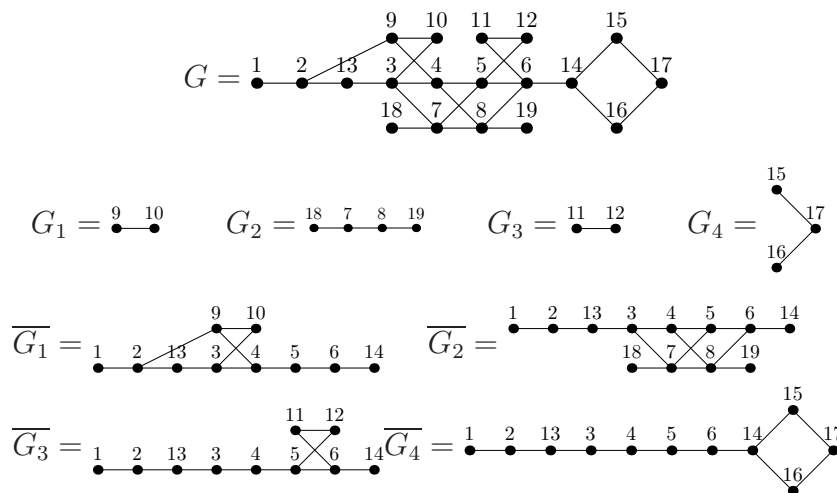

FIG. 8.11 – A graph G with a chain c , the components G_i of $G \setminus c$ and the corresponding regions \overline{G}_i .

We can now state our third main result :

Theorem 8.18. *Let G be a graph, c a chain of G and $\overline{G}_1, \overline{G}_2, \dots, \overline{G}_k$ be the corresponding*

regions of G . Then one has :

$$N(G) = \prod_{j=1}^k N(\overline{G_j}).$$

For example, the numerator of the rational function associated to the graph of Figure 8.11 can be written as a product of four non-trivial factors.

Proof. The central idea is to apply Theorem 8.4 on cycles C contained in one region and such that $E(C) \cap c = \emptyset$. This means that the edges of c can appear in C , but only in the *wrong* direction : so, when we apply Proposition 8.7, we do not cut the chain c .

The first step is to prove the existence of such cycles. This is done in Lemma 8.19 (see Figure 8.12 for an illustration).

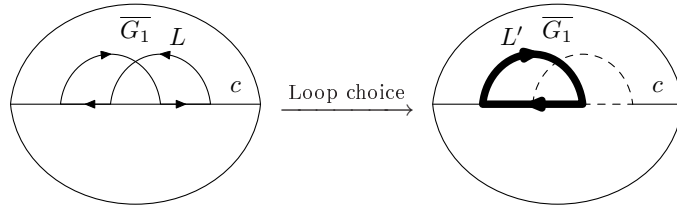

FIG. 8.12 – Good choice of cycle

Lemma 8.19. *Let G be a graph and c a chain of G . Denote by $\overline{G_1}, \dots, \overline{G_k}$ the corresponding regions. If $\overline{G_1}$ is not a tree, there exists a cycle C in $\overline{G_1}$ such that $E(C) \cap c = \emptyset$.*

Proof. Choose any cycle C_0 of $\overline{G_1}$. Two cases have to be examined :

1. The cycle C_0 has no vertices in common with c . Nothing has to be done.
2. The cycle $C_0 = (e_1, \dots, e_l)$ has at least one vertex in common with c . As a cycle is not transformed if one makes a cyclic permutation of its edges, one can assume that $c_1 = \text{ext}_1(e_1)$ is a vertex of c . Let us denote by h the smallest index such that $c_2 = \text{ext}_2(e_h)$ is also a vertex of c (it necessarily exists because $\text{ext}_2(e_l) = \text{ext}_1(e_1)$ is a vertex of c). But there is a subchain (eventually empty) c' of c going from c_1 to c_2 (resp. from c_2 to c_1) if $c_1 \leq c_2$ (resp. if $c_2 \leq c_1$). Now, we just have to define C as :

$$L = \begin{cases} (e_1, \dots, e_l) \cdot \overline{c'} & \text{if } c_1 \leq c_2 \\ (e_l, \dots, e_1) \cdot \overline{c'} & \text{if } c_2 \leq c_1 \end{cases},$$

where $\overline{c'}$ denotes the chain c' in the other direction (this implies that all the edges of c' are in the *wrong* direction in C , so $E(C) \cap c = \emptyset$).

□

Let us come back to the proof of Theorem 8.18. We make a proof by induction on k : if $k = 1$, then the result is trivial.

Suppose now that our proposition is true for $k = n - 1$. Let G be a graph and c a chain of G , such that there are n associated regions $\overline{G}_1, \dots, \overline{G}_n$.

If \overline{G}_1 is a tree, one can prune it to obtain the chain c . We can remove the same vertices and edges from the whole graph G because the removed vertices are not linked with an other G_i (as the G_i are different connected components of $G \setminus V_c$). Thanks to the pruning-invariance Lemma 8.2, one has :

$$N(G) = N\left(\bigcup_{i=2}^n \overline{G}_i\right) = \prod_{i=2}^n N(\overline{G}_i),$$

where the second equality is due to the induction hypothesis. The theorem is proved in this case.

If \overline{G}_1 is not a tree, we proceed by induction over the cyclomatic number of \overline{G}_1 .

Lemma 8.19 gives us a cycle C_1 of \overline{G}_1 such that $E(C_1) \cap c = \emptyset$. Applying Proposition 8.7 on C , one has

$$N(G) = \sum_{\substack{E_1 \subset E(C_1) \\ E_1 \neq \emptyset}} \pm N(G \setminus E_1) \left(\prod_{e \in E_1} x_e \right).$$

Some of the graphs $G \setminus E_1$ are disconnected (if and only if $\overline{G}_1 \setminus E_1$ is disconnected). The value of N on these graphs is 0. So they do not appear in the formulas 166 and 167.

Each connected graph $G \setminus E_1$ contains the chain c (thanks to the assumption $E(C_1) \cap c = \emptyset$). The associated regions are $\overline{G}_2, \dots, \overline{G}_n$ and $\overline{G}_1 \setminus E_1$ (the last region can in fact be a union of several regions but it does not matter). But $\overline{G}_1 \setminus E_1$ has a strictly lower cyclomatic number than \overline{G}_1 so we can use the induction hypothesis

$$N(G \setminus E_1) = N(\overline{G}_1 \setminus E_1) \cdot N(\overline{G}_2) \cdot \dots \cdot N(\overline{G}_n).$$

Finally,

$$N(G) = \left(\sum_{\substack{E_1 \subset E(C_1) \\ E_1 \neq \emptyset}} \pm \prod_{e \in E_1} (x_{\alpha(e)} - x_{\omega(e)}) N(\overline{G}_1 \setminus E_1) \right) \cdot N(\overline{G}_2) \cdot \dots \cdot N(\overline{G}_n), \quad (166)$$

where the sum is restricted to the sets E_1 such that $G \setminus E_1$ is connected. But we can use Proposition 8.7 with the same cycle C in G_1 :

$$N(\overline{G}_1) = \sum_{\substack{E_1 \subset E(C_1) \\ E_1 \neq \emptyset}} \pm \prod_{e \in E_1} (x_{\alpha(e)} - x_{\omega(e)}) N(\overline{G}_1 \setminus E_1), \quad (167)$$

where the sum is also restricted to the sets E_1 such that $\overline{G}_1 \setminus E_1$ is connected, or equivalently such that $G \setminus E_1$ is connected.

This ends the proof of Theorem 8.18.

8.7.2 Complete factorization of planar posets

In his paper [Gre92], C. Greene has given a closed expression for the sum $\Psi(G)$ when G is the minimal graph (Hasse diagram) of a *planar* poset (Theorem 8.20). In this case, the numerator $N(G)$ can be written as a product of terms of degree 1 (Theorem 8.20). We will see that this factorization property is a consequence of Theorem 8.18 and give a new proof of Greene’s Theorem.

Let us begin by defining precisely planar posets :

Définition 8.9. We will say that the drawing of an oriented graph (without circuit) is ordered-embedded in $\mathbb{R} \times \mathbb{R}$ if

- the origin of an edge is always at the left of its end ;
- the edges are straight lines.

A graph G is said planar if it can be ordered embedded in $\mathbb{R} \times \mathbb{R}$ without edge-crossings. If G is a graph, we denote by $G_{0,\infty}$ the graph obtained from G by adding :

- A vertex 0 (called *minimal* vertex) and, for each vertex v of G which is not the end of any edge of G , an edge going from 0 to v .
- A vertex ∞ (called *maximal* vertex) and, for each vertex v of G which is not the origin of any edge of G , an edge going from v to ∞ .

A graph G is said strongly planar if the graph $G_{0,\infty}$ is planar.

A poset \mathcal{P} is *planar* if its minimal graph G is strongly planar.

Almost all drawings of this paper (except in section 8.6) are ordered-embedded in $\mathbb{R} \times \mathbb{R}$. See Figure 8.13 and 8.14 for examples of strongly planar and non strongly planar graphs.

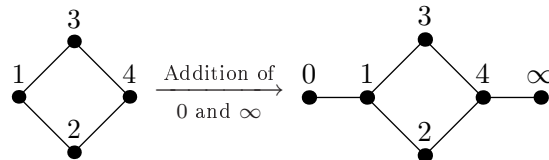

FIG. 8.13 – The graph G is strongly planar.

Note that the complete subgraph on a subset of vertices of a strongly planar graph is strongly planar (note that, however, if we erase some edges, we can obtain a non strongly planar graph). In particular, the regions of a strongly planar graph with respect to a chain are the graph of strongly planar graphs.

Moreover, a graph with one cycle and without vertices with arity 1 is strongly planar if and only if it has a unique maximal and a unique minimal element. In this case, we will call it a diamond (an example is drawn on Figure 8.15).

These definitions are relevant because there is a closed formula for $\Psi_{\mathcal{P}}$ for planar posets :

Theorem 8.20 (Greene [Gre92]). *Let P be a planar poset, then :*

$$\Psi_{\mathcal{P}} = \begin{cases} 0 & \text{if } P \text{ is not connected;} \\ \prod_{y,z \in P} (x_y - x_z)^{\mu^P(y,z)} & \text{if } P \text{ is connected,} \end{cases}$$

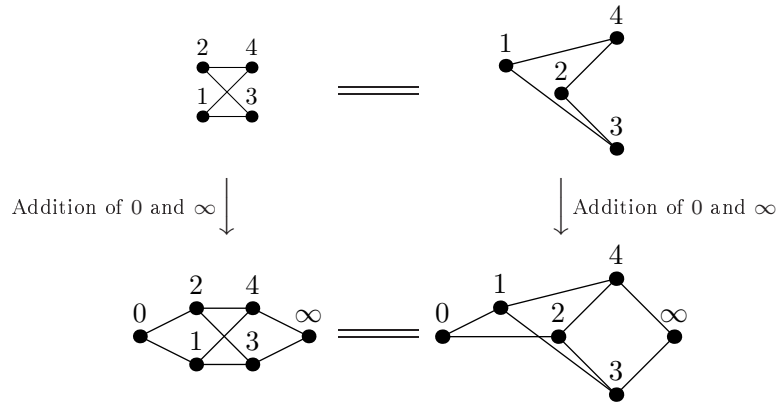

FIG. 8.14 – The graph G is planar, but not strongly planar.

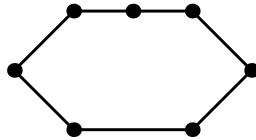

FIG. 8.15 – A diamond

where $\mu_P(x, y)$ denotes the Möbius function of the poset P .

We will show that we can find disconnecting chains in any strongly planar graphs, explaining the fact that the function $N(G)$ can be factorized into factors of degree 1.

Proposition 8.21. *Let G be a strongly planar oriented graph with a number of cycle greater than 1, then there is a chain of G , separating G in two non-trivial regions (each region contains at least one cycle).*

Proof. Eventually by pruning it, one can assume that G has no vertices with arity 1. As it has at least two cycles, it has one vertex c_2 of arity 3 or more. So, up to a left-right symmetry, we are in one of the two following cases (in the second case, we assume that c_2 is the end of exactly 2 edges).



In the first case, let us label the vertices as below :

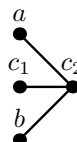

In the second case, we define by induction c_i for $i \geq 3$: we choose for c_i any vertex such that there is an edge of origin c_{i-1} and of end c_i . For a $k \geq 3$, one can not define c_{k+1} if c_k is not the origin of any edge. Then, as c_k is not a vertex of arity 1, it is the end of an edge coming from a vertex $b \neq c_{k-1}$. Finally, we call c_1 and a the origins of the two edges whose ends are c_2 : which one is c_1 and which one is a depends of whether b is above or below c_{k-1} (see the figure below).



In every case, the c_i are the vertices of a chain c of G , which can be extended to a maximal chain c_{\max} . Recall that with Greene’s definition of a planar graph, the graph $G_{0,\infty}$, i.e. can still be ordered-embedded in the plan. Then there is a chain in $G_{0,\infty}$ containing v_0 , c_{\max} and v_∞ . It splits $G_{0,\infty}$ into at least two regions, one containing a and one containing b . The same is true for the chain c_{\max} in G . But, as G has no vertices, the corresponding regions have at least one cycle. □

Corollary 8.22. *Let G be a connected strongly planar poset. By iterating chain factorization, one can write $N(G)$ as a product of numerators of rational functions associated to diamonds.*

Proof. Proposition 8.21 and Theorem 8.18 imply that $N(G)$ can be factorized as the product of numerators of subgraphs with one cycle. As these subgraphs are strongly planar, after pruning, they are diamonds, which ends the proof. □

Note that for a diamond, the function N has a close expression (paragraph 8.5.1) :

$$N(D) = x_{\min(D)} - x_{\max(D)},$$

or equivalently,

$$\Psi(D) = \prod_{y,z \in P} (x_y - x_z)^{\mu_D(y,z)},$$

where μ_D is the Möbius function of the poset associated to the diamond D .

The last property can be extended to any planar poset thanks to the following compatibility between disconnecting chain and Möbius function :

Proposition 8.23. *Let P be a poset, c a chain of the Hasse diagram of P (i.e. the minimal graph representing P), P_1, \dots, P_n the n region associated with c , and i, j two different elements of P , then*

$$\mu_P(i, j) = \begin{cases} -1 & \text{if } i \preceq j, \\ \sum_{k=1}^n \mu_{P_k}(i, j) & \text{otherwise.} \end{cases}$$

We assume that $\mu_Q(i, j) = 0$ if $i \notin Q$ or $j \notin Q$.

The proof is postponed to paragraph 8.7.3.

This proposition together with corollary 8.22 proves Greene theorem. In fact, this proof works also for some non-planar posets (and hence Greene formula is true for these posets). For example, the poset of the figure 8.16 is not planar but can be factorised and the numerator can be expressed with the Möbius function : this is the case of any gluing of diamonds along chains.

$$\begin{aligned}
 N \left(\begin{array}{c} \bullet & & \bullet & & \bullet & & \bullet & & \bullet \\ & \nearrow & & \searrow & & \nearrow & & \searrow & \\ \bullet & & \bullet & & \bullet & & \bullet & & \bullet \\ & \searrow & & \nearrow & & \searrow & & \nearrow & \\ & & \bullet & & \bullet & & \bullet & & \bullet \\ & & & & \bullet & & & & \\ & & & & & & & & \bullet \\ & & & & & & & & & \bullet \end{array} \right) = N \left(\begin{array}{c} \bullet & & \bullet & & \bullet \\ & \nearrow & & \searrow & \\ \bullet & & \bullet & & \bullet \\ & \searrow & & \nearrow & \\ & & \bullet & & \bullet \\ & & & & \bullet \\ & & & & & & & & \bullet \\ & & & & & & & & & \bullet \end{array} \right) \cdot N \left(\begin{array}{c} \bullet & & \bullet & & \bullet \\ & \nearrow & & \searrow & \\ \bullet & & \bullet & & \bullet \\ & \searrow & & \nearrow & \\ & & \bullet & & \bullet \\ & & & & \bullet \\ & & & & & & & & \bullet \\ & & & & & & & & & \bullet \end{array} \right) \\
 & \cdot N \left(\begin{array}{c} \bullet & & \bullet & & \bullet & & \bullet \\ & \nearrow & & \searrow & & \nearrow & & \searrow & \\ \bullet & & \bullet & & \bullet & & \bullet & & \bullet \\ & \searrow & & \nearrow & & \searrow & & \nearrow & \\ & & \bullet & & \bullet & & \bullet & & \bullet \\ & & & & \bullet & & & & \\ & & & & & & & & \bullet \\ & & & & & & & & & \bullet \end{array} \right) \\
 & = (x_1 - x_4) \cdot (x_2 - x_5) \cdot (x_3 - x_6)
 \end{aligned}$$

FIG. 8.16 – A non-planar poset for which Greene’s formula is true.

8.7.3 Disconnecting chain and Möbius function

This paragraph is the proof of the technical Proposition 8.23

Proof. When $i \preceq j$ (there is an edge from i to j in the Hasse diagram of the poset), one always has $\mu_P(i, j) = -1$.

When $i \leq j$, but $i \not\preceq j$, four cases have to be examined :

- first case :** i, j do not belong to V_c and in different regions of the poset ;
- second case :** i, j do not belong to V_c , but are in the same region of the poset ;
- third case :** i is an element of V_c , but j is not ;
- fourth case :** i and j are two elements of V_c .

Figure 8.17, 8.18, 8.19 and 8.20 summarize the four cases. Note that the case where i does not belong to V_c , but j does, can be obtained from the third one by considering the opposite poset.

Let P_1, \dots, P_n be the n regions associated with P .

We denote by $[a, b]_P$ the set

$$[a, b]_P = \{k \mid a \leq_P k \leq_P b\},$$

and by $[a, b[_P$ the set

$$[a, b[_P = \{k \mid a \leq_P k <_P b\}.$$

Note that $[i, j]_{P_1} = [i, j]_P \cap P_1$. This property is not true for any poset associated to a complete subgraph of G , the fact that P_1 is a region defined by a disconnecting chain is here very important.

If $[i, j]_P$ has a non-empty intersection with V_c , we denote by L the maximal element of this intersection.

1. Suppose that $i \in P_2 \setminus V_c$ and $j \in P_1 \setminus V_c$. We want to prove that $\mu_P(i, j) = 0$ and we assume (proof by induction) that it is true for any $j' \in P_1 \setminus V_c$ such that $j' < j$.

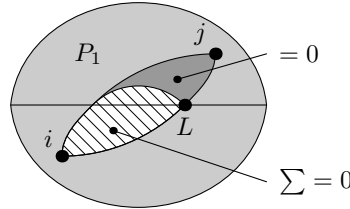

FIG. 8.17 – Case 1 : $i \notin V_c$ and j is not in the same region than i .

As $i \leq j$, there is a chain in the Hasse diagram of P going from i to j . As c is a chain separating P_1 and P_2 , any chain from i to j intersect V_c . Thus L exists and any element between i and j which is not in P_1 , is lower or equal to L . So

$$[i, j]_P \cap (P_2 \cup \dots \cup P_m) \subseteq [i, L]_P \subseteq [i, j]_P.$$

By definition of the Möbius function we obtain,

$$\mu_P(i, j) = - \sum_{k \in [i, L]_P} \mu_P(i, k) - \sum_{k \in [i, j]_P \cap P_1 \setminus [i, L]_P} \mu_P(i, k)$$

As

$$\sum_{k \in [i, L]_P} \mu_P(i, k) = 0$$

one has :

$$\mu_P(i, j) = - \sum_{k \in [i, j]_P \cap P_1 \setminus [i, L]_P} \mu_P(i, k) \tag{168}$$

By induction hypothesis, $\mu_P(i, j) = 0$.

2. Suppose now that $i, j \in P_1 \setminus V_c$. We want to prove that $\mu_P(i, j) = \mu_{i, j}(P_1)$

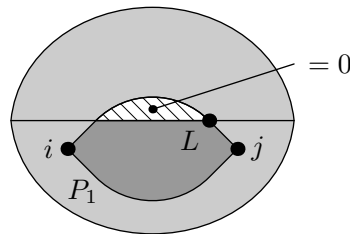

FIG. 8.18 – Case 2 : $i \notin V_c$ and j is in the same region than i .

By definition of the Möbius function, we have,

$$\mu_P(i, j) = - \sum_{k \in [i, j]_P \cap (P_2 \cup \dots \cup P_m \setminus V_c)} \mu_P(i, k) - \sum_{k \in [i, j]_{P_1}} \mu_P(i, k).$$

Case 1 gives : $\sum_{k \in [i,j]_P \cap (P_2 \cup \dots \cup P_m \setminus V_c)} \mu_P(i, j) = 0$. Therefore,

$$\mu_P(i, j) = \sum_{k \in [i,j]_{P_1}} \mu_P(i, j). \tag{169}$$

and an immediate induction proves that $\mu_P(i, j) = \mu_{i,j}(P_1)$.

- Suppose that $i \in V_c$ and $j \in P_1 \setminus V_c$. As $i \in V_c \cap [i, j]_P$, the set is not empty and L exists.

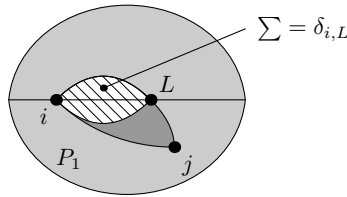

FIG. 8.19 – Case 3 : $i \in V_c$ and $j \notin V_c$.

We will prove now that $\mu_P(i, j) = \mu_{i,j}(P_1)$ by induction on j . As

$$\sum_{k \in [i,L]_P} \mu_P(i, k) = \delta_{i,L}$$

one has :

$$\mu_P(i, j) = - \sum_{k \in [i,j]_P \setminus [i,L]_P} \mu_P(i, k) - \delta_{i,L}$$

Similarly,

$$\mu_{i,j}(P_1) = - \sum_{k \in [i,j]_{P_1} \setminus [i,L]_P} \mu_{i,k}(P_1) - \delta_{i,L}$$

But $[i, j]_P \setminus [i, L]_P = [i, j]_{P_1} \setminus [i, L]_P$ (see the proof of case 1), so an immediate induction on j finishes the proof in this case.

- Suppose that $i \in V_c$ and $j \in V_c$. We want to prove by induction on j ($i \not\leq j$) that $\mu_P(i, j) = \sum_{l=1}^n \mu_{P_l}(i, j)$.

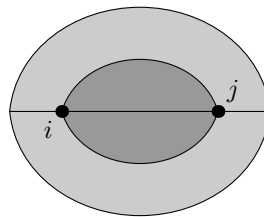

FIG. 8.20 – Case 4 : i and j belong to V_c .

By definition of the Möbius function, we have

$$\mu_P(i, j) = - \sum_{k \in [i,j]_P} \mu_P(i, k)$$

Using case 3 of this proof and the induction hypothesis, we know that $\mu_P(i, k) = \sum_{l=1}^n \mu_{P_l}(i, k)$ if $k \in [i, j]_P$ except for :

$\mathbf{k} = \mathbf{i}$ In this case, $\mu_P(i, i) = \mu_{P_l}(i, i) = 1$, thus $\mu_P(i, i) = \sum_{l=1}^n \mu_{P_l}(i, i) - (n - 1)$.

$\mathbf{k} = \mathbf{i}_1$ where i_1 is defined by $i_1 \in V_c$ and $i \preceq i_1$. In this case, one has $\mu_P(i, i_1) = \mu_{P_l}(i, i_1) = -1$, thus $\mu_P(i, i_1) = \sum_{l=1}^n \mu_{P_l}(i, i_1) + (n - 1)$.

Finally, one has :

$$\mu_P(i, j) = \sum_{l=1}^n \left(- \sum_{k \in [i, j]_P \setminus c} \mu_{P_l}(i, k) \right) - (n - 1) + (n - 1).$$

Using the definition of the Möbius function for the P_l , this ends the proof of the proposition.

□

Conclusion

Regarder le caractère normalisé $\hat{\chi}^\lambda(\mu)$ comme une fonction de λ nous a permis d'obtenir de nombreux résultats. Premièrement, nous avons établi une nouvelle formule pour les valeurs des caractères, qui avait été conjecturée par R.P. Stanley. Cette formule a été grandement utilisée dans la suite de la thèse. Par exemple, elle permet d'établir des bornes supérieures sur les caractères ou d'agrandir le domaine de validité d'équivalents connus. Une autre application est une description combinatoire (en termes de paires de permutations ou, de manière équivalente, de cartes bicolores) des coefficients des polynômes de Kerov. Outre la preuve d'un résultat de positivité conjecturé par Kerov, cela donne un développement topologique des valeurs des caractères.

Cela ouvre des perspectives de recherche intéressantes. Un premier domaine est constitué par les questions ouvertes concernant les polynômes de Kerov : en effet les résultats analytiques de I.P. Goulden et A. Rattan [GR07] et les conjectures de M. Lassalle [Las08d] (voir paragraphe 3.3.1) semblent suggérer que la structure combinatoire n'est pas entièrement comprise. Il sera intéressant d'essayer de prouver ces résultats à partir de notre interprétation combinatoire : une piste pour cela est d'utiliser la réduction d'une carte à son squelette et de compter les contributions des cartes ayant un squelette donné. Ainsi, outre leur intérêt intrinsèque (sur l'asymptotique des caractères irréductibles du groupe symétrique par exemple), ces formules sont des guides pour comprendre en profondeur la combinatoire sous-jacente à ce problème.

Il serait aussi intéressant d'étudier d'autres familles d'observables des diagrammes de Young, ainsi que les graduations associées. Par exemple, dans [KO94], les auteurs suggèrent d'écrire les caractères irréductibles renormalisés du groupe symétrique en fonction des puissances des coordonnées de Frobenius. Un autre exemple de ce type de développement est l'expression explicite du caractère sur les puissances des contenus des cases du diagramme [Las08b]. Mais il n'existe pas pour l'instant de description combinatoire de ces changements de base.

Dans leurs travaux [OO98a], A. Okounkov et G. Olshanski ont introduit une autre famille de fonctions intéressantes sur les diagrammes de Young : les fonctions de Schur décalées [OO98b]. Leur définition et propriétés de base sont semblables à celles des fonctions de Schur et l'expression des caractères centraux sur ces fonctions est connue. Au vu de notre travail de thèse, il est naturel de chercher des expressions des fonctions de Schur shiftées en termes des $N(G)$ ou des observables du diagrammes. Nous espérons faire apparaître un

développement topologique intéressant de ces fonctions, qui pourrait éventuellement être étendu au polynôme de Jack ou de MacDonalD décalés (qui ont aussi été étudiés par ces auteurs).

Par ailleurs, les relations entre observables des diagrammes peuvent être vues comme une série de relations dans chaque $Z(\mathbb{C}[S_n])$, dont les coefficients ne dépendent pas de n (voir paragraphe 2.2.4). Cela fait apparaître des familles d'éléments intéressantes : par exemple, les puissances transitives de $\xi_n = \sum_{i < n} (i \ n)$ [GJ08] ou certaines fonctions symétriques en les éléments de Jucys-Murphy ξ_i (qui correspondent aux fonctions symétriques des contenus du diagramme). Parmi ces dernières, certaines établissent des liens avec des domaines connexes qu'il sera intéressant d'examiner et/ou d'étendre : les intégrales sur le groupe unitaire pour les fonctions homogènes [Nov08] et les opérateurs vertex et les algèbres de Virasoro dans le cas des fonctions puissances [LT01] (il paraît plausible que d'autres algèbres apparaissent pour certaines autres familles de fonctions).

Obtenir des développements topologiques des formules liant ces observables devrait permettre de créer une série de méthodes efficaces pour étudier asymptotiquement un certain nombre de problèmes en théorie asymptotique des représentations. Par exemple, l'existence des polynômes de Kerov permet d'étudier facilement la convergence et les fluctuations de suites de représentations du groupe symétrique (voir le paragraphe 3.2.4 et l'article [Šni06b]). Grâce aux interprétations combinatoires des coefficients des polynômes de Kerov, il sera peut-être possible d'étudier le comportement de moments dont l'ordre varie avec la taille du groupe symétrique. Comme le fait Okounkov pour la mesure de Plancherel [Oko00], on pourra alors étudier finement les fluctuations de la plus longue ligne et/ou colonne sous d'autres mesures. Ces outils nous permettront de voir si il y a un résultat d'universalité de ces fluctuations, comme dans le cas des matrices aléatoires [Sos99].

Un autre objectif est l'amélioration des bornes connues (en particulier celles établies dans cette thèse) sur les caractères dans le cas de diagrammes de Young λ typiques pour la mesure de Plancherel (ces diagrammes ont des petits cumulants libres, sauf le deuxième). Ces questions apparaissent naturellement dans la théorie des marches aléatoires sur des graphes [MSP07] et dans des calculs de complexité d'algorithmes quantiques [MRŠ07].

L'étude des autres bases peut aussi déboucher sur des résultats de ce type. Par exemple, les fonctions puissance des coordonnées de Frobenius évoquées plus haut sont adaptées à l'étude de diagramme de Young ayant quelques grandes lignes et grandes colonnes. C'est le cas par exemple des grands diagrammes typiques pour la q -mesure de Plancherel (liée à une représentation de l'algèbre de Hecke de type A). Rappelons par ailleurs que les fonctions de Schur décalées apparaissent dans les représentations des groupes de Lie usuels (comme $GL(n)$, $SO(2n+1)$, $Sp(2n)$, $O(2n)$, voir [OO98b]) : les outils de cette thèse pourront éventuellement servir dans cet autre contexte.

Conclusion

We have obtained in this thesis some results on the (normalized) character values $\hat{\chi}^\lambda(\mu)$ seen as a function in λ . Firstly, we have stated a new formula, conjectured by R.P. Stanley. This formula has been widely used in the other chapters. For instance, one can deduce from it new upper bounds for character values and for error terms in some known equivalents. Another application is a combinatorial description of Kerov's polynomials (in terms of pairs of permutations or, equivalently, bicolored labeled maps). Besides a proof of a positivity conjecture of S.V. Kerov, it gives a genus expansion of character values.

It opens interesting research directions. For instance, the analytic expression of I.P. Goulden and A. Rattan [GR07] and Lassalle's conjectures [Las08d] for Kerov's polynomials (see paragraph 3.3.1) suggest that the combinatorial structure is not entirely understood. A future work consists in trying to find these expressions via our combinatorial interpretation : for this, we will begin by counting the contribution of all maps with a given skeleton. Besides their inner interest, these formulas will help us to understand the underlying combinatorics.

It would also be interesting to study other families of functionals of Young diagrams. For instance, in [KO94], the authors suggest to write normalized irreducible character values of the symmetric group in terms of power sums of Frobenius coordinates. Another example of this kind of expansion is the explicit expression of the character values on the power sums of the contents of the diagram boxes [Las08b]. But it does not exist until now any combinatorial description of these changes of basis.

In their paper [OO98a], A. Okounkov and G. Olshanski introduced another family of interesting functions on Young diagrams : shifted Schur functions. Their definition and basic properties are very close to that of Schur functions and the expression of normalized character values in terms of these functions are known. It is natural, after reading this thesis, to look for expressions of shifted Schur functions in terms of the $N(G)$ or in terms of the other diagram functionals. We hope to obtain a simple genus expansion of them. This could perhaps be generalized to shifted MacDonalld or Jack polynomials which have also been considered by these authors.

In another direction, we have seen that the relations between functionals of diagrams can be seen as a sequence of relations in each $Z(\mathbb{C}[S_n])$, whose coefficients do not depend on n (see paragraph 2.2.4). This invites us to look at some others interesting families : for instance, the transitive powers of $\xi_n = \sum_{i < n} (i \ n)$ or symmetric functions evaluated in Jucys-Murphy

elements ξ_i (the latter correspond to symmetric functions in the alphabet of the diagram contents). Among them, some have links with other domains : integrals on unitary group for homogeneous function [Nov08] and vertex operator and Virasoro algebras for power sums [LT01] (this connection might be extended to other families of functions).

Formulas of changes of basis can be used in asymptotic representation theory. For instance, the existence of Kerov's polynomials implies in some cases the convergence and the fluctuation of representations of symmetric groups (see paragraph 3.2.4 and article [Šni06b]). With the values of their coefficient, we might be able to study the asymptotic behaviour of cumulants, whose order increases with the size of the symmetric group. As Okounkov does in the case of Plancherel's measure [Oko00], this would allow us to study the fluctuation of the biggest row or column of the diagram (with other probability measures than Plancherel's : is there a universality result for these fluctuations as in random matrix theory [Sos99]?).

Another goal is to improve our upper bound on characters when λ is a typical Young diagram for the Plancherel measure (that implies that all cumulants, except for R_2 , are small). Upper bounds on characters have some applications, for instance to study random walks on graphs [MSP07] or to compute the complexity of some quantum algorithms [MRŠ07].

Other basis can also be used to state this type of results. For instance, power sums of Frobenius coordinates suit in the study of Young diagrams with a few big rows and/or a few big columns. This is the case of typical diagrams for the q -Plancherel measure (linked with a representation of the Hecke algebra in type A). Let us also recall that shifted Schur functions appear in representation theory of classical Lie groups (as $GL(n)$, $SO(2n+1)$, $Sp(2n)$, $O(2n)$) [OO98b] : one may also obtain some results in this context.

Bibliographie

- [Ber08] O. Bernardi. A characterization of the tutte polynomial via combinatorial embedding. *Annals of Combinatorics*, 12(2) :139–153, 2008.
- [BF09] A. Boussicault and V. Féray. Application of graph combinatorics to rational identities of type A. Preprint arXiv :math/0811.2526, 2009.
- [Bia97] P. Biane. Some properties of crossings and partitions. *Discrete Math.*, 175(1-3) :41–53, 1997.
- [Bia98] P. Biane. Representations of symmetric groups and free probability. *Adv. Math.*, 138(1) :126–181, 1998.
- [Bia01a] P. Biane. Approximate factorization and concentration for characters of symmetric groups. *Internat. Math. Res. Notices*, 4 :179–192, 2001.
- [Bia01b] P. Biane. Free cumulants and representations of large symmetric groups. In *XIIIth International Congress on Mathematical Physics (London, 2000)*, pages 321–326. Int. Press, Boston, MA, 2001.
- [Bia03] P. Biane. Characters of symmetric groups and free cumulants. In *Asymptotic combinatorics with applications to mathematical physics (St. Petersburg, 2001)*, volume 1815 of *Lecture Notes in Math.*, pages 185–200. Springer, Berlin, 2003.
- [Bia07] P. Biane. On the formula of Goulden and Rattan for Kerov polynomials. *Sém. Lothar. Combin.*, 55 :Art. B55d, 5 pp. (electronic), 2007.
- [BMB07] M. Bousquet-Melou and S. Butler. Forest-like permutations. *Annals of Combinatorics*, 11 :335–354, 2007.
- [Bou07] A. Boussicault. Operations on posets and rational identities of type A. *International Conference on Formal Power Series and Algebraic Combinatorics*, 19, 2007.
- [CGS04] S. Corteel, A. Goupil, and G. Schaeffer. Content evaluation and class symmetric functions. *Adv. Math.*, 188(2) :315–336, 2004.
- [Dem74] M. Demazure. Une nouvelle formule des caractères. *Bull. Sci. Math.*, 98 :163–172, 1974.
- [DFŚ08] M. Dołęga, V. Féray, and P. Śniady. Explicit combinatorial interpretation of kerov character polynomials as numbers of permutation factorizations. Preprint arXiv :math/0810.3209, 2008.
- [DH04] K. Dykema and U. Haagerup. Invariant subspaces of the quasinilpotent DT-operator. *J. Funct. Anal.*, 209(2) :332–366, 2004.

- [Die05] R. Diestel. *Graph Theory*. Springer-Verlag Heidelberg, 2005. Graduate Texts in Mathematics **173**.
- [Fér08a] V. Féray. Combinatorial interpretation and positivity of Kerov's character polynomials. *J. Alg. Comb*, 2008. to appear.
- [Fér08b] V. Féray. Proof of Stanley's conjecture about irreducible character values of the symmetric group. *Annals of Combinatorics*, 2008. to appear.
- [FŚ07] V. Féray and P. Śniady. Asymptotics of characters of symmetric groups related to Stanley-Féray character formula. Preprint arXiv :math/0701051, 2007.
- [GJ92] I. P. Goulden and D. M. Jackson. The combinatorial relationship between trees, cacti and certain connection coefficients for the symmetric group. *European J. Combin.*, 13(5) :357–365, 1992.
- [GJ08] I.P. Goulden and D.M. Jackson. Transitive powers of young-jucys-murphy elements are central. submitted, 2008.
- [GR07] I. P. Goulden and A. Rattan. An explicit form for Kerov's character polynomials. *Trans. Amer. Math. Soc.*, 359(8) :3669–3685 (electronic), 2007.
- [Gre92] C. Greene. A rational function identity related to the Murnaghan-Nakayama formula for the characters of s_n . *J. Alg. Comb.*, 1(3) :235–255, 1992.
- [IK99] V. Ivanov and S. Kerov. The algebra of conjugacy classes in symmetric groups, and partial permutations. *Zap. Nauchn. Sem. S.-Peterburg. Otdel. Mat. Inst. Steklov. (POMI)*, 256(Teor. Predst. Din. Sist. Komb. i Algoritm. Metody. 3) :95–120, 265, 1999.
- [IO02] V. Ivanov and G. Olshanski. Kerov's central limit theorem for the Plancherel measure on Young diagrams. In *Symmetric functions 2001 : surveys of developments and perspectives*, volume 74 of *NATO Sci. Ser. II Math. Phys. Chem.*, pages 93–151. Kluwer Acad. Publ., Dordrecht, 2002.
- [Juc74] A. Jucys. Symmetric polynomials and the center of the symmetric group ring. *Reports Math. Phys.*, 5 :107–112, 1974.
- [Ker93] S. Kerov. The asymptotics of interlacing sequences and the growth of continual Young diagrams. *Zap. Nauchn. Sem. S.-Peterburg. Otdel. Mat. Inst. Steklov. (POMI)*, 205(Differentsialnaya Geom. Gruppy Li i Mekh. 13) :21–29, 179, 1993.
- [Ker98] S.V. Kerov. Interlacing measures. In *Kirillov's seminar on representation theory*, volume 181 of *Amer. Math. Soc. Transl. Ser. 2*, pages 35–83. Amer. Math. Soc., Providence, RI, 1998.
- [Ker99] S. Kerov. A differential model for the growth of Young diagrams. In *Proceedings of the St. Petersburg Mathematical Society, Vol. IV*, volume 188 of *Amer. Math. Soc. Transl. Ser. 2*, pages 111–130, Providence, RI, 1999. Amer. Math. Soc.
- [Ker00] S. Kerov. Talk in institute henri poincaré, paris. January 2000.
- [Ker03] S. V. Kerov. *Asymptotic representation theory of the symmetric group and its applications in analysis*, volume 219 of *Translations of Mathematical Monographs*.

- American Mathematical Society, Providence, RI, 2003. Translated from the Russian manuscript by N. V. Tsilevich, With a foreword by A. Vershik and comments by G. Olshanski.
- [KO94] S. V. Kerov and G. I. Olshanski. Polynomial functions on the set of Young diagrams. *C. R. Acad. Sci. Paris, Serie. I*(319) :121–126, 1994.
- [Kre72] G. Kreweras. Sur les partitions non croisées d'un cycle. *Discrete Math*, 1(4) :333–350, 1972.
- [KV77] S.V. Kerov and A. Vershik. Asymptotics of the Plancherel measure of the symmetric group and the limiting form of Young tableaux. *Sov. Math. Dokl.*, 18 :527–531, 1977.
- [KV85] S.V. Kerov and A. Vershik. Asymptotics of maximal and typical dimensions of irreducible representations of a symmetric group. *Funct. Anal. Appl.*, 19 :21–31, 1985.
- [Las08a] A. Lascoux. Schubert and macdonald polynomials, a parallel. preprint available online : www-igm.univ-mlv.fr/~al/ARTICLES/MsriExp.pdf, 2008.
- [Las08b] M. Lassalle. An explicit formula for the characters of the symmetric group. *Mathematische Annalen*, 340 :383–405, 2008.
- [Las08c] M. Lassalle. Jack polynomials and free cumulants. Preprint arXiv :0802.0448, 2008.
- [Las08d] M. Lassalle. Two positivity conjectures for Kerov polynomials. *Advances in Applied Mathematics*, 41 :407–422, 2008.
- [LS77] B. F. Logan and L. A. Shepp. A variational problem for random Young tableaux. *Advances in Math.*, 26(2) :206–222, 1977.
- [LT01] A. Lascoux and J.Y. Thibon. Vertex operators and the class algebras of symmetric groups. *Zap. Nauchn. Sem. S.-Peterburg. Otdel. Mat. Inst. Steklov. (POMI)*, 283 :156–177, 2001.
- [LZ04] S. K. Lando and A. K. Zvonkin. *Graphs on surfaces and their applications*, volume 141 of *Encyclopaedia of Mathematical Sciences*. Springer-Verlag, Berlin, 2004. With an appendix by Don B. Zagier, Low-Dimensional Topology, II.
- [Mac95] I.G. Macdonald. *Symmetric functions and Hall polynomials*. Oxford Univ. Press, second edition, 1995.
- [MR06] C. Moore and A. Russell. On the impossibility of a quantum sieve algorithm for graph isomorphism. Preprint quant-ph/0609138, 2006.
- [MRŚ07] C. Moore, A. Russell, and P. Śniady. On the impossibility of a quantum sieve algorithm for graph isomorphism. pages 536–545, 2007.
- [MSP07] T. Müller and J.-C. Schlage-Puchta. Character theory of symmetric groups, subgroup growth of fuchsian groups, and random walks. *Adv. Math.*, 213 :919–982, 2007.
- [MT01] B. Mohar and C. Thomassen. *Graphs on Surfaces*. J. Hopkins Univ. Press, 2001.
- [Mur81] G. Murphy. A new construction of Young's seminormal representation of the symmetric group. *J. Algebra*, 69 :287–291, 1981.

- [Nov08] J. Novak. Jucys-murphy elements and the unitary weingarten function. *11th Workshop on Noncommutative Harmonic Analysis with Applications to Probability*, 2008. to appear.
- [Oko96a] A. Okounkov. Quantum immanants and higher Capelli identities. *Transformation Groups*, 1(1-2) :99–126, 1996.
- [Oko96b] A. Okounkov. Young basis, Wick formula, and higher Capelli identities. *International Mathematics Research Notices*, 17 :817–839, 1996.
- [Oko00] A. Okounkov. Random matrices and random permutations. *Internat. Math. Res. Notices*, 20 :1043–1095, 2000.
- [OO98a] A. Okounkov and G. Olshanski. Shifted Schur functions. *St. Petersburg Math. J.*, 9 :239–300, 1998.
- [OO98b] A. Okounkov and G. Olshanski. Shifted Schur functions II. Binomial formula for characters of classical groups and applications. *Kirillov’s Seminar on Representation Theory. Amer. Math. Soc. Transl.*, pages 245–271, 1998.
- [OV96] A. Okounkov and A. Vershik. New approach to representation theory of symmetric groups. *Selecta Math.*, 2(4) :1–15, 1996.
- [Rat07a] A. Rattan. Positivity results for Stanley’s character polynomials. *J. Algebra*, 308(1) :26–47, 2007.
- [Rat07b] A. Rattan. Stanley’s character polynomials and coloured factorizations in the symmetric group. *J. Combin. Theory Ser. A*, in press, 2007.
- [Roi96] Y. Roichman. Upper bound on the characters of the symmetric groups. *Invent. Math.*, 125(3) :451–485, 1996.
- [RŚ08] A. Rattan and P. Śniady. Upper bound on the characters of the symmetric groups for balanced Young diagrams and a generalized Frobenius formula. *Adv. Math.*, 218(3) :673–695, 2008.
- [Sag01] B. Sagan. *The symmetric group : Representations, Combinatorial Algorithms, and Symmetric functions*. Springer, New York, second edition, 2001.
- [Shl96] D. Shlyakhtenko. Random Gaussian band matrices and freeness with amalgamation. *Internat. Math. Res. Notices*, 20 :1013–1025, 1996.
- [Śni03] P. Śniady. Multinomial identities arising from free probability theory. *J. Combin. Theory Ser. A*, 101(1) :1–19, 2003.
- [Śni06a] P. Śniady. Asymptotics of characters of symmetric groups, genus expansion and free probability. *Discrete Math.*, 306(7) :624–665, 2006.
- [Śni06b] P. Śniady. Gaussian fluctuations of characters of symmetric groups and of Young diagrams. *Probab. Theory Related Fields*, 136(2) :263–297, 2006.
- [Śni06c] P. Śniady. Generalized Cauchy identities, trees and multidimensional Brownian motions. I. Bijective proof of generalized Cauchy identities. *Electron. J. Combin.*, 13(1) :Research Paper 62, 27 pp. (electronic), 2006.
- [Śni06d] P. Śniady. Limit distributions of many-particle spectra. In Marek Bożejko, Wojciech Młotkowski, and Janusz Wysoczański, editors, *Quantum Probability*, volume 73 of *Banach Center Publ.*, pages 409–414. Polish Acad. Sci., Warsaw, 2006.

- [Sos99] A. Soshnikov. Universality at the edge of the spectrum in Wigner random matrices. *Commun. Math. Phys.*, 207 :697–733, 1999.
- [Spe93] R. Speicher. The lattice of admissible partitions. In *Quantum probability & related topics*, QP-PQ, VIII, pages 347–352. World Sci. Publ., River Edge, NJ, 1993.
- [Spe98] R. Speicher. Combinatorial theory of the free product with amalgamation and operator-valued free probability theory. *Mem. Amer. Math. Soc.*, 132(627) :x+88, 1998.
- [SS98] Y. G. Sinai and A. B. Soshnikov. A refinement of Wigner’s semicircle law in a neighborhood of the spectrum edge for random symmetric matrices. *Funktsional. Anal. i Prilozhen.*, 32(2) :56–79, 1998.
- [Sta02] R. P. Stanley. Kerov’s character polynomial and irreducible symmetric group characters of rectangular shape. Transparencies from a conference in Québec City, June 2002.
- [Sta03] R. P. Stanley. Irreducible symmetric group characters of rectangular shape. *Sém. Lothar. Combin.*, 50 :Art. B50d, 11 pp. (electronic), 2003.
- [Sta06] R. P. Stanley. A conjectured combinatorial interpretation of the normalized irreducible character values of the symmetric group. Preprint arXiv :math.CO/0606467, 2006.
- [Ste85] J. R. Stembridge. A characterization of supersymmetric polynomials. *J. Algebra*, 95 :439–444, 1985.
- [Tut63] W. T. Tutte. A census of planar map. *Canad. J. Math.*, 14 :21–38, 1963.
- [VDN92] D. V. Voiculescu, K. J. Dykema, and A. Nica. *Free random variables*, volume 1 of *CRM Monograph Series*. American Mathematical Society, Providence, RI, 1992. A noncommutative probability approach to free products with applications to random matrices, operator algebras and harmonic analysis on free groups.
- [VK77] A. M. Vershik and S. V. Kerov. Asymptotic behavior of the Plancherel measure of the symmetric group and the limit form of Young tableaux. *Dokl. Akad. Nauk SSSR*, 233(6) :1024–1027, 1977.
- [VK81] A. M. Vershik and S. V. Kerov. Characters and factor representations of the infinite symmetric group. *Dokl. Akad. Nauk SSSR*, 257(5) :1037–1040, 1981.
- [Voi86] D. Voiculescu. Addition of certain noncommuting random variables. *J. Funct. Anal.*, 66(3) :323–346, 1986.
- [Voi91] D. Voiculescu. Limit laws for random matrices and free products. *Invent. Math.*, 104(1) :201–220, 1991.
- [Zvo97] A. Zvonkin. Matrix integrals and map enumeration : an accessible introduction. *Math. Comput. Modelling*, 26(8-10) :281–304, 1997. Combinatorics and physics (Marseille, 1995).